

# DELL™ PowerVault™ LTO3-060 Tape Drive User's Guide

---

The information below is provided by the supplier of the referenced device without independent verification by Dell and is subject to the [restrictions and disclaimers](#) noted below.

---

[Introduction](#)

[Setting Up the Tape Drive](#)

[Using the Tape Drive](#)

[Using the Tape Backup Software](#)

[Troubleshooting](#)

[Specifications](#)

[Glossary](#)

---



**NOTE:** A NOTE indicates important information that helps you make better use of your system.



**NOTICE:** A NOTICE indicates either potential damage to hardware or loss of data and tells you how to avoid the problem.



**CAUTION:** A CAUTION indicates a potential for property damage, personal injury, or death.

**Information in this document is subject to change without notice.**

© 2006 Dell Inc. All rights reserved.

© International Business Machines Corporation, 2006. All rights reserved.

Trademarks used in this text: *Dell*, *PowerVault*, and the *DELL* logo are trademarks of Dell Inc. *Microsoft* and *Windows* are registered trademarks of Microsoft Corporation.

Other trademarks and trade names may be used in this document to refer to either the entities claiming the marks and names or their products. Dell Inc. disclaims any proprietary interest in trademarks and trade names other than its own.

---

## Restrictions and Disclaimers

The information contained in this document, including all instructions, cautions, and regulatory approvals and certifications, is provided by the supplier and has not been independently verified or tested by Dell. Dell cannot be responsible for damage caused as a result of either following or failing to follow these instructions.

All statements or claims regarding the properties, capabilities, speeds, or qualifications of the part referenced in this document are made by the supplier and not by Dell. Dell specifically disclaims knowledge of the accuracy, completeness, or substantiation for any such statements. All questions or comments relating to such statements or claims should be directed to the supplier.

---

Model Number on Regulatory Label: LTO Ultrium 3-H

---

*Initial release: December 2006*

## Glossary: DELL™ PowerVault™ LTO3-060 Tape Drive User's Guide

[A](#) - [B](#) - [C](#) - [D](#) - [E](#) - [F](#) - [G](#) - [H](#) - [I](#) - [J](#) - [L](#) - [M](#) - [N](#) - [O](#) - [P](#) - [R](#) - [S](#) - [T](#) - [U](#) - [V](#) - [W](#)

---

### Numbers

**2:1 compression.** The relationship between the quantity of data that can be stored with compression as compared to the quantity of data that can be stored without compression. In 2:1 compression, twice as much data can be stored with compression as can be stored without compression.

### A

**A.** See **ampere**.

**ampere (A).** A unit of measure for electric current that is equivalent to a flow of one coulomb per second, or equivalent to the current produced by one volt applied across a resistance of one ohm.

**adapter.** See **adapter card**.

**adapter card.** A circuit board that adds function to a computer.

### B

**backups.** The short-term retention of records used for restoring essential business and server files when vital data has been lost because of program or server errors or malfunctions.

**backward compatible.** Capable of being used with a previous product that was designed for a similar purpose. For example, a tape cartridge that is designed to be used with a modern tape drive but can also be used with certain older tape drives. Synonymous with *downward compatible*.

**bezel.** The removable frame that fits over the front of the tape drive.

**burst data transfer rate.** The maximum speed at which data is transferred.

**byte.** A string that consists of a certain number of bits (usually 8) which are treated as a unit and represent a character. A byte is a fundamental unit of data.

### C

**C.** See **Celsius**.

**capacity.** The amount of data that can be contained on storage media and expressed in bytes.

**cartridge.** See **tape cartridge**.

**cartridge door.** On a tape cartridge, the hinged barrier that can be opened to access, or closed to protect, the magnetic tape within the cartridge.

**cartridge memory.** See **LTO cartridge memory**.

**Celsius (C).** Having a thermostatic scale on which the interval between the freezing point and the boiling point of water is divided into 100 degrees, with 0 degrees representing the freezing point and 100 degrees representing the boiling point.

**cleaning cartridge.** A tape cartridge that is used to clean the heads of a tape drive. Contrast with *data cartridge*.

**clockwise.** In the direction that the hands of a clock rotate, as viewed from the front.

**compression.** The process of eliminating gaps, empty fields, redundancies, and unnecessary data to shorten the length of records or blocks.

**configure.** To describe to a server the devices, optional features, and programs installed on the system.

**counterclockwise.** In a direction opposite to that in which the hands of a clock rotate, as viewed from the front.

**current.** The quantity of charge per unit of time. Current is measured in amperes.

**cycle power.** To apply and remove electrical power to a device within a short time span.

## D

**data.** Any representations such as characters or analog quantities to which meaning is, or might be, assigned.

**data cartridge.** A tape cartridge that is dedicated to storing data. Contrast with cleaning cartridge.

**data compression.** See **compression**.

**data transfer rate.** The average number of bits, characters, or blocks per unit of time that pass between corresponding equipment in a data transmission system. The rate is expressed in bits, characters, or blocks per second, minute, or hour.

**DC.** See **direct current**.

**degauss.** To make a magnetic tape nonmagnetic by exposing the tape to electrical coils which carry currents that neutralize the magnetism of the tape.

**device.** Any hardware component or peripheral, such as a tape drive or tape library, that can receive and send data.

**device driver.** A file that contains the firmware that is needed to use an attached device.

**diagnostic.** A software program that is designed to recognize, locate, and explain faults in equipment or errors in programs.

**direct current (DC).** An electric current flowing in one direction only and substantially constant in value.

**drive.** A data-storage device that controls the movement of the magnetic tape in a tape cartridge. The drive houses the mechanism (drive head) that reads and writes data to the tape.

**drive dump.** The recording, at a particular instant, of the contents of all or part of one storage device into another storage device, usually as a safeguard against faults or errors, or in connection with debugging.

**drive head.** The component that records an electrical signal onto magnetic tape, or reads a signal from tape into an electrical signal.

**drive sense data.** See **SCSI drive sense data**.

**dump.** See **drive dump**.

## E

**eject.** To remove or force out from within.

**enclosure.** A device, such as a desktop unit, tape cartridge autoloader, or tape library, into which you can install the tape drive.

**error log.** Maintained by the tape drive, a list that contains the ten most recent error codes. The codes identify errors that pertain to the drive.

## F

**F.** See **Fahrenheit**.

**Fahrenheit (F).** Of or relating to a temperature scale that registers the freezing point of water as 32 degrees and the boiling point as 212 degrees at one atmosphere of pressure.

**file.** A named set of records that are stored or processed as a unit.

**firmware.** The proprietary code that is usually delivered as part of an operating system. Firmware is more efficient than software that is loaded from an alterable medium, and is more adaptable to change than pure hardware circuitry. An example of firmware is the Basic Input/Output System (BIOS) in read-only memory (ROM) on a PC motherboard.

## G

**GB.** See **gigabyte**.

**Generation 1.** The informal name for the Ultrium tape drive, which is the predecessor of the tape drive (Generation 2). The Generation 1 drive has a native storage capacity of up to 100 GB per cartridge and a native sustained data transfer rate of 15 MB per second.

**Generation 2.** The informal name for the Ultrium 2 Tape Drive, which is the second-generation version of the Ultrium tape drive (Generation 1). The Generation 2 drive has a native storage capacity of up to 200 GB per cartridge and a native sustained data transfer rate of 35 MB per second.

**Generation 3.** The informal name for the Ultrium 3 Tape Drive, which is the third-generation version of the Ultrium tape drive (Generation 1, 2). The Generation 3 drive has a native storage capacity of up to 400 GB per cartridge and a native sustained data transfer rate of 80 MB per second.

**gigabyte.** 1,000,000,000 bytes.

**ground.** An object that makes an electrical connection with the earth.

## H

**hardware.** The physical equipment or devices that form a computer.

**head.** See **drive head**.

**Head Resistance Measurements test.** Part of the Test Head diagnostic, a procedure that determines whether the tape drive's head works correctly. The test measures the head's ability to withstand cracks and other defects.

**host.** The controlling or highest-level system in a data communication configuration. Synonymous with *server*.

## I

**ID.** Identifier.

**in.** See **inch**.

**inch.** A unit of length equal to 1/36 yard or 25.4 mm.

**input/output (I/O).** Data that is provided to a computer or data that results from computer processing.

**insertion guide.** On the surface of the tape cartridge, a large, notched area that prevents you from inserting the cartridge incorrectly.

**install.** (1) To set up for use or service. (2) The act of adding a product, feature, or function to a server or device either by a singular change or by the addition of multiple components or devices.

**interposer.** An adapter-like device that allows a connector of one size and style to connect to a mating connector of a different size and style. Data provided to the computer or data resulting from computer processing.

**I/O.** See **input/output**.

## J

**jumper.** (1) A tiny connector that fits over a pair of protruding pins in a connector. A jumper can be moved to change electrical connectors. When in place, the jumper connects the pins electrically.

(2) To place a jumper on a connector pin.

## L

**label.** A slip of paper with an adhesive backing that can be written on and affixed to a tape cartridge as a means of identification or description.

**label area.** On the LTO Ultrium Tape Cartridge, a recessed area next to the write-protect switch where a bar code label must be affixed.

**leader block.** Located within the tape drive, the part that engages the steel pin which is attached to the tape in an LTO Ultrium Tape Cartridge. Once engaged, the leader-pin block pulls the tape from the cartridge into the drive.

**leader pin.** On the tape cartridge, a small metal column that is attached to the end of the magnetic tape. During tape processing the leader pin is grasped by a threading mechanism, which pulls the pin and the tape out of the cartridge, across the drive head, and onto a takeup reel. The head can then read or write data from or to the tape.

**LED.** See **light-emitting diode**.

**light-emitting diode.** A semiconductor diode that emits light when subjected to an applied voltage and that is used in an electronic display.

**Linear Tape-Open (LTO).** A type of tape storage technology developed by the IBM Corporation, Hewlett-Packard, and Seagate. LTO technology is an "open format" technology, which means that its users have multiple sources of product and media. The "open" nature of LTO technology enables compatibility between different vendors' offerings by ensuring that vendors comply with verification standards.

**load.** Following the insertion of a tape cartridge into the tape load compartment, the act of positioning the tape (performed by the tape drive) for reading or writing by

the drive's head.

**log sense data.** See **SCSI log sense data.**

**loop.** (1) A series of instructions that is repeated until a terminating condition is reached.  
(2) To connect so as to complete a loop.

**Low Voltage Differential (LVD).** A low-noise, low-power, and low-amplitude electrical signaling system that enables data communication between a supported server and the tape drive. LVD signaling uses two wires to drive one signal over copper wire. The use of wire pairs reduces electrical noise and crosstalk.

**LTO.** See **Linear Tape-Open.**

**LVD.** See **Low Voltage Differential.**

## M

**magnetic tape.** A tape with a magnetizable surface layer on which data can be stored by magnetic recording.

**maintenance mode.** The state of operation in which the tape drive must be before it can run diagnostics, verify write and read operations, verify a suspect tape cartridge, update its own firmware, and perform other diagnostic and maintenance functions.

**MB.** See **megabyte.**

**media.** The plural of *medium*.

**medium.** A physical material in or on which data may be represented, such as magnetic tape.

**megabyte (MB).** 1,000,000 bytes.

## N

**network.** A configuration of data processing devices and software that is connected for information interchange.

## O

**oersted.** The unit of magnetic field strength in the unrationalized centimeter-gram-second (cgs) electromagnetic system. The oersted is the magnetic field strength in the interior of an elongated, uniformly wound solenoid that is excited with a linear current density in its winding of one ampere per 4 pi centimeters of axial length.

**offline.** The operating condition that the tape drive is in when the server's applications cannot interact with it.

**online.** The operating condition that the tape drive is in when the server's applications can interact with it.

**Open Systems.** Computer systems whose standards are not proprietary.

**operating environment.** The temperature, relative humidity rate, and wet bulb temperature of the room in which the tape drive routinely conducts processing.

## P

**parity.** The state of being even-numbered or odd-numbered. A parity bit is a binary number that is added to a group of binary numbers to make the sum of that group always odd (odd parity) or even (even parity).

**parity error.** A transmission error that occurs when the received data does not have the parity that is expected by the receiving system. This usually occurs when the sending and receiving systems have different parity settings.

**port.** (1) A system or network access point for data entry or exit.  
(2) A connector on a device to which cables for other devices such as display stations and printers are attached.  
(3) The representation of a physical connection to hardware. A port is sometimes referred to as an adapter; however, there can be more than one port on an adapter.

**power connector.** Located at the rear of the tape drive, the connector to which the internal power cable of an enclosure connects.

**power cord.** A cable that connects a device to a source of electrical power.

**power-off.** To remove electrical power from a device.

**power-on, powered-on.** (1) To apply electrical power to a device.  
(2) The state of a device when power has been applied to it.

## R

**read.** To acquire or interpret data from a storage device, from a data medium, or from another source.

**reboot.** To reinitialize the execution of a program by repeating the initial program load (IPL) operation.

**record.** The smallest distinct set of data bytes that is supplied from a server for processing and recording by a tape drive, and the smallest distinct set of data to be read from tape, reprocessed, and made available to a server by a tape drive.

**relative humidity.** The ratio of the amount of water vapor actually present in the air to the greatest amount possible at the same temperature.

**reset.** To return a device or circuit to a clear state.

## S

**scratch cartridge.** A data cartridge that contains no useful data, but can be written to with new data.

**SCSI.** See **Small Computer Systems Interface.**

**SCSI bus.** (1) A collection of wires through which data is transmitted from one part of a computer to another.

(2) A generic term that refers to the complete set of signals that define the activity of the Small Computer Systems Interface (SCSI).

**SCSI connector.** Located at the rear of the tape drive, the connector that facilitates commands to and from the server, and to which the internal SCSI cable of an enclosure connects.

**SCSI device.** Anything that can connect into the SCSI bus and actively participate in bus activity.

**SCSI drive sense data.** In response to inquiry from the server about an error condition, a packet of SCSI sense bytes that contains information about the error and that is sent back to the server by the drive.

**SCSI ID.** The unique address (from 1 to 15) that you assign to a tape drive that uses a SCSI interface.

**SCSI ID connector.** Located at the rear of the tape drive, the connector that enables the drive's SCSI address to be set. Addresses are determined by the placement of jumpers on the pins.

**SCSI interface.** See **Small Computer Systems Interface.**

**SCSI log sense data.** In response to inquiry from the server about the tape drive's error logs and counters, a packet of SCSI sense bytes which contains that information and which is sent back to the server by the drive. Log sense data is used to diagnose problems, especially if the problems are intermittent.

**second.** One sixtieth of a minute.

**sense data.** Data that describes an I/O error. Sense data is presented to a server in response to a Sense I/O command.

**server.** A functional unit that provides services to one or more clients over a network. Examples include a file server, a print server, or a mail server. The IBM pSeries, IBM iSeries, HP, and Sun are servers. Synonymous with host.

**single-character display.** Located at the front of the tape drive, an LED that presents an alphabetical or numeric code which represents a diagnostic or maintenance function, error condition, or informational message.

**sleep mode.** A power-management function that causes the tape drive's electronics to automatically enter a low-power mode by which to conserve energy.

**Small Computer Systems Interface (SCSI).** A standard used by computer manufacturers for attaching peripheral devices (such as tape drives, hard disks, CD-ROM players, printers, and scanners) to computers (servers). Pronounced "scuzzy." Variations of the SCSI interface provide for faster data transmission rates than standard serial and parallel ports (up to 160 megabytes per second). The variations include:

- 1 Fast/Wide SCSI: Uses a 16-bit bus, and supports data rates of up to 20 MBps.
- 1 SCSI-1: Uses an 8-bit bus, and supports data rates of 4 MBps.
- 1 SCSI-2: Same as SCSI-1, but uses a 50-pin connector instead of a 25-pin connector, and supports multiple devices.
- 1 Ultra SCSI: Uses an 8- or 16-bit bus, and supports data rates of 20 or 40 MBps.
- 1 Ultra2 SCSI: Uses an 8- or 16-bit bus and supports data rates of 40 or 80 MBps.
- 1 Ultra3 SCSI: Uses a 16-bit bus and supports data rates of 80 or 160 MBps.
- 1 Ultra160 SCSI: Uses a 16-bit bus and supports data rates of 160 MBps.

**software.** Programs, procedures, rules, and any associated documentation pertaining to the operation of a computer system.

**speed matching.** A technique used by the tape drive to dynamically adjust its native (uncompressed) data rate to the slower data rate of a server. Speed matching improves system performance and reduces backhitch.

**status light.** Located at the front of the tape drive, an LED that can be green or amber, and (when lit) solid or flashing. The condition of the light represents the state of the drive.

## T

**TapeAlert.** A patented technology and ANSI standard that defines conditions and problems that are experienced by tape drives.

**TapeAlert flags.** Status and error messages that are generated by the TapeAlert utility and display on the server's console.

**tape cartridge.** A removable storage case that houses belt-driven magnetic tape that is wound on a supply reel and a takeup reel.

**tape drive.** A data-storage device that controls the movement of the magnetic tape in a tape cartridge. The DELL PowerVault LTO3-060 tape drive houses the mechanism (drive head) that reads and writes data to the tape. Its native data capacity is 400 GB per cartridge; with 2:1 compression, its capacity is up to 800 GB.

**tape path.** Within a tape drive, the channel in which the media moves.

**terminate.** To prevent unwanted electrical signal reflections by applying a device (known as a terminator) that absorbs the energy from the transmission line.

**terminator.** (1) A part that is used to end a SCSI bus.

(2) A single-port, 75-ohm device that is used to absorb energy from a transmission line. Terminators prevent energy from reflecting back into a cable plant by absorbing the radio frequency signals. A terminator is usually shielded, which prevents unwanted signals from entering or valid signals from leaving the cable system.

**Test Head diagnostic.** A test that determines whether the heads of the tape drive are operating properly and whether the drive can correctly read from and write to tape.

**transfer rate.** See **data transfer rate**.

## U

**Ultra160 LVD SCSI interface.** See **Small Computer Systems Interface**.

**unload.** The act (performed by the drive) of unthreading tape from the drive's internal tape path and returning it (with the leader block) to the tape cartridge.

**utility.** See **utility program**.

**utility program.** A computer program that supports computer processes. For example, a diagnostic program, a trace program, or a sort program.

## V

**VDC.** Volts DC (direct current).

**volt.** The SI (international) unit of potential difference and electromotive force. Formally defined as the difference of electric potential between two points of a conductor that carries a constant current of one ampere when the power dissipated between these points is equal to one watt.

## W

**wet bulb temperature.** The temperature at which pure water must be evaporated adiabatically at constant pressure into a given sample of air in order to saturate the air under steady-state conditions. Wet bulb temperature is read from a wet bulb thermometer.

**write.** To make a permanent or transient recording of data in a storage device or on a data medium.

**write protected.** Applicable to a tape cartridge, the condition that exists when some logical or physical mechanism prevents a device from writing on the tape in that cartridge.

**write-protect switch.** Located on the tape cartridge, a switch that prevents accidental erasure of data. Pictures of a locked and unlocked padlock appear on the switch. When you slide the switch to the locked padlock, data cannot be written to the tape. When you slide the switch to the unlocked padlock, data can be written to the tape.

**Write/Read test.** Part of the Test Head diagnostic, a procedure that determines whether the tape drive can correctly read from and write to tape.

[Back to Contents Page](#)

## Introduction: DELL™ PowerVault™ LTO3-060 Tape Drive User's Guide

- [Overview](#)
  - [SCSI Bus Interface](#)
  - [Features](#)
  - [Tape Backup Software](#)
  - [Front Panel](#)
  - [Rear Panel](#)
  - [Status LEDs](#)
  - [Operating Modes](#)
  - [Unload Button](#)
  - [Interpreting Operation Mode Status LEDs](#)
- 

### Overview

The Dell PowerVault LTO3-060 is a high-performance, high-capacity tape storage device that is designed to backup and restore data and archive and retrieve files in an Open Systems environment. The drive can be integrated into a computer system such as a tower or rack server. The Dell PowerVault LTO3-060 tape drive is a half-high version of the Dell PowerVault 110T LTO-3 Tape Drive.

The LTO3-060 tape drive offers a formatted cartridge capacity of up to 400 GB (800 GB assuming 2:1 compression ratio) and a data transfer rate of 60 MB per second.

[Figure 1](#) shows the Dell PowerVault LTO3-060 tape drive.

**Figure 1. Dell PowerVault LTO3-060 tape drive**

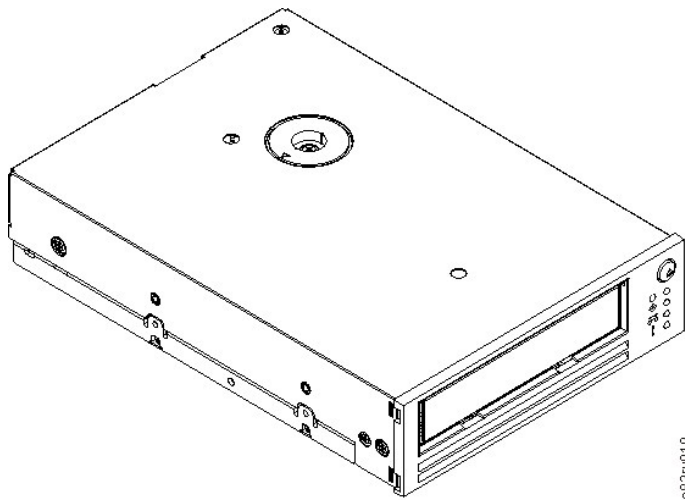

---

### SCSI Bus Interface

These tape drives are designed to operate on an Ultra160 low voltage differential (LVD) SCSI bus with a burst transfer rate of 160 MB per second. The interface is backward compatible with older SCSI technology.

The tape drive contains a high-density, 68-pin, D-Shell (HD-68) connector for attachment to the system. The drive supports LVD SCSI cables with HD-68 connectors.

---

### Features



The tape drive has the following features:

- 1 Capacity of 400 GB (native), 800 GB (compressed\*) on a single LTO tape
- 1 Built-in read-after-write verification for a high level of data integrity
- 1 Data transfer rate of 60 MB per second (native), 120 MB per second (compressed\*)
- 1 128 MB of read/write cache memory
- 1 Intelligent LTO-DC dual-mode compression algorithm
- 1 Failsafe leader capture mechanism with pin pick error recovery
- 1 LTO-Cartridge memory
- 1 TapeAlert support for worry-free backup
- 1 Ultra160 LVD SCSI interface
- 1 Speed matching (The tape drive can slow down to match the system data rate.)
- 1 Sleep mode for energy conservation
- 1 Backward read and write compatibility with Generation 2 cartridges
- 1 Backward read compatibility with Generation 1 cartridges
- 1 Compatible with all cartridges that bear the official Ultrium LTO logo
- 1 Will interchange tapes with other LTO tape drives that bear the official Ultrium LTO logo
- 1 Cartridge Auto-Eject on over-temperature function safely unloads a cartridge when an over temperature condition is detected.\*\*
- 1 Four LED operator panel configuration
- 1 New service mode operations

\* Assumes 2:1 compression. The capacity and transfer rate you realize in practice depends on the data set, which affects the actual compression ratio.

\*\* If the drive is in the process of writing host data to the cartridge, the drive will stop accepting data from the host and will automatically flush (write) all buffered data to tape. After cooling down, the drive can resume normal operations.

---

## Tape Backup Software

You need backup software that supports the Dell PowerVault LTO3-060 tape drive. As a general rule, native backup applications (such as NTBackup and tar) do not provide the required data streaming rate to get the full performance of your tape drive. We recommend using a backup application, which provides better memory management as well as other useful features, such as TapeAlert. For the latest supported software versions, go to [support.dell.com](http://support.dell.com) or visit the support site of your backup software vendor.

---

## Front Panel

Operating the Half-high drive involves using the following front panel items shown in [Figure 2](#):

**Figure 2. Front panel of the Half-high drive**

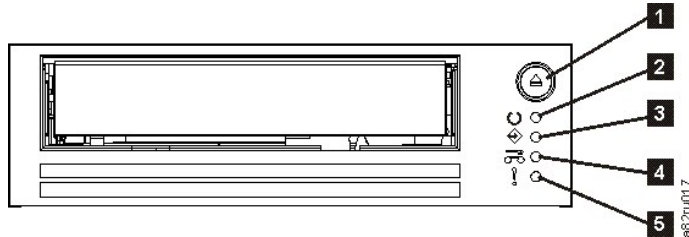

(1) - Unload button

(2) (  ) - Ready status LED (green)

(3) (  ) - Activity status LED (green)

(4) (  ) - Clean status LED (amber)

(5) (  ) - Fault status LED (amber)

---

## Rear Panel

**Figure 3. Half-high SCSI drive rear panel element descriptions**

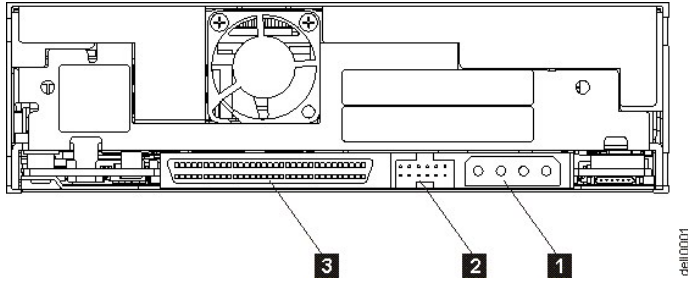

1. Power connector
2. SCSI ID connector
3. SCSI connector

## Status LEDs

Each status LED has four modes:

- 1 OFF
- 1 ON
- 1 Flashing slowly (at 2 Hz)
- 1 Flashing rapidly (at 8 Hz)

## Operating Modes

The drive functions in the following modes:

- 1 Operation mode - functions include using data and cleaning cartridges, reporting errors and updating firmware. For more information, see [Table 2. Interpretation of status LEDs in Operation mode \(No Errors\)](#) below.
- 1 Service mode - functions include a drive diagnostic test and methods of saving or erasing drive diagnostic information called a "dump" which can then be used by trained service personnel to troubleshoot a tape problem. For more information, see [Service Mode](#) in the Troubleshooting section.

The Unload button is used to switch between modes. For more information, see [Unload Button](#).

## Unload Button

The Unload button (1) in [Figure 2](#) performs the following functions:

**Table 1. Functions that the Unload button performs**

| Unload button function  | How to initiate the function  |
|---|---|
| Rewind the tape into the cartridge and eject the cartridge from the drive | Press the Unload button once. The Activity LED flashes green while the drive is rewinding and unloading.  |
| Exit Operation mode and Enter Service mode                                | Ensure that the drive is unloaded. Then, press and hold the Unload button until the Ready LED begins flashing rapidly (approximately 6 seconds).<br><br><b>Note:</b> While in Service mode, the drive does not accept commands from the server.   |
| Scroll through the Service Functions                                      | While in Service mode, press the Unload button once per second to increment the Service Functions by one. When you reach the desired Service Functions, select it by either inserting a cartridge into the drive (Service Function 1) or double-clicking the Unload button (Service Functions 2, 4, and 5). See <a href="#">Table 1. Service Mode</a> for more information.   |
| Exit Service mode and Enter Operation mode                                | Press the Unload button once per second until you have scrolled through all Service mode selections. Service mode is exited when all LEDs are off except for Ready LED which is on solid. The drive will exit Service mode if there is no Unload button activity for 15 seconds. See <a href="#">Table 1. Service Mode</a> for more information.  |
| Force a drive dump  | <b>Attention:</b> If the drive detects a permanent error, it automatically forces a drive dump (also known as a save of the firmware trace). Captured dump data is placed in drive RAM. If you force a drive dump, the existing dump will be overwritten and it will be lost. After you force a drive dump, do not turn off the power to the drive or you may lose the dump data. To permanently save a dump to non volatile memory, see <a href="#">Executing Service Function 4: Copy dump to flash</a> . A dump that is saved to flash memory will persist thru a drive power cycle.<br><br>To force a dump, choose one of the following procedures: <ol style="list-style-type: none"> <li>1 If the drive is in Service mode, scroll to and select Service Function 2 (see <a href="#">Executing Service Function 2: Force dump</a>).</li> <li>1 If the drive is in Operation mode, press and hold the Unload button for 12 seconds.</li> </ol> |





|   |   |
|---|---|
| Cartridge Emergency Eject and Reset the drive | Press and hold the Unload button on the drive for 12 seconds. The drive saves a dump of the current drive state to RAM, then reboots. After the reboot, the cartridge is slowly rewound to the beginning of tape (this may take some time). Another press of the unload button will eject the cartridge.<br><br><b>Attention: Do not cycle power as this will erase the contents of the dump.</b> |
|---|---|

## Interpreting Operation Mode Status LEDs

The front panel LEDs ((2), (3), (4), and (5) in [Figure 2](#)) indicate the current status of the drive.

The following table gives information on interpreting the status LEDs while the drive is in Operation mode and there are no errors. If there are errors, go to the Troubleshooting section, [Table 3. Interpretation of status LEDs in Operation mode \(Error Conditions\)](#).

**Table 2. Interpretation of status LEDs in Operation mode (No Errors).**

| LED icon  | Power-on LED Test   | Power-on Self Test (POST) in progress | A cartridge is not loaded | A cartridge is not loaded; drive needs cleaning | Cartridge loaded, no activity | Cartridge loaded, no activity; drive needs cleaning | Data cartridge loaded, activity | Data cartridge loaded, activity; drive needs cleaning | Cleaning cartridge loaded, activity | Cartridge is loading or unloading | Cartridge is loading or unloading; drive needs cleaning | Firmware download in progress | Firmware download in progress; drive needs cleaning | Firmware update in progress | Firmware update in progress; drive needs cleaning |
|---|---------------------|---------------------------------------|---------------------------|---|-------------------------------|---|---------------------------------|---|-------------------------------------|-----------------------------------|---|-------------------------------|---|-----------------------------|---|
|    | ●<br>(for 2.0 sec.) | ◈                                     | ●                         | ●   | ●                             | ●   | ●                               | ●   | ●                                   | ●                                 | ●   | ◈                             | ◈   | ◈                           | ◈   |
|    | ●<br>(for 2.0 sec.) | ●                                     | ●                         | ●   | ●                             | ●   | ◈                               | ◈   | ◈                                   | ◈                                 | ◈   | ●                             | ●   | ◈                           | ◈   |
|  | ●<br>(for 2.0 sec.) | ●                                     | ●                         | ●   | ●                             | ●   | ●                               | ●   | ●                                   | ●                                 | ●   | ●                             | ●   | ●                           | ●   |
|  | ●<br>(for 2.0 sec.) | ●                                     | ●                         | ●   | ●                             | ●   | ●                               | ●   | ●                                   | ●                                 | ●   | ●                             | ●   | ●                           | ●   |

<sup>1</sup> LEDs are turned on during Boot process for 2 seconds.

<sup>2</sup> A solid amber "Clean" LED indicates that the drive needs cleaning. In most cases the drive will continue to function, but it should be cleaned as soon as possible.

<sup>3</sup> "Firmware download" refers to the transfer of firmware from the host to the drive.

<sup>4</sup> "Firmware update" refers to the drive incorporating the new firmware.

**Key:**

- = OFF
- = ON
- ◈ = Flashing slowly

Please read all [restrictions and disclaimers](#).

[Back to Contents Page](#)

[Back to Contents Page](#)

## Setting Up the Tape Drive: DELL™ PowerVault™ LTO3-060 Tape Drive User's Guide

- [Pre-installed Internal Drives](#)
  - [Installing Internal Drives](#)
  - [Loading Device Drivers](#)
  - [Verifying Drive Operation](#)
- 

### Pre-installed Internal Drives

Dell performs the installation and setup of internal tape drives that are shipped as part of a system. If tape backup software is included in your system, refer to the installation instructions included with the software.

For the latest supported software versions, go to [support.dell.com](http://support.dell.com) or visit the support site of your backup software vendor

---

### Installing Internal Drives

If your internal tape drive is not pre-installed, the installation instructions are as follows:

Note: Be sure to install and configure the drive according to the instructions provided in the Dell documentation for your system.

#### Installing the Drive — Prerequisites

Dell PowerVault LTO3-060 tape drives are Ultra160 LVD SCSI devices with a burst transfer rate of 160 MB per second. Do not use the drive on a single-ended SCSI bus, as performance is restricted. Do not use on the same bus as other single-ended devices, as this will switch the LVD host adapter into single-ended mode and restrict performance. We recommend that a dedicated host bus adapter is used for the tape drive.

The tape drives have a 68-pin wide, high-density SCSI connector. If you are using a tape drive on an internal bus with other peripherals that run at Ultra2 speeds, it is important that a 68-pin LVD-compatible ribbon cable is used.

#### Mounting Bay

You need one industry-standard, 5 1/4-inch, half-height bay in which to install the PowerVault LTO3-060 tape drive. The drive may be mounted vertically or horizontally.

#### Mounting Hardware

Most systems use trays or rails to mount the tape drive. For some systems, no tray or rails are required. Devices simply slide into the system's chassis and are fixed with screws.

#### Installing the Drive — Step-By-Step Instructions

##### Step 1 — Unpacking the Drive

Unpack the tape drive and store the packaging. You may need the packaging if you return the unit for service.

A period of time is required if the temperature of the drive when unpacked is different than the temperature of its operating environment (measured at the front of the bezel near the air intake area; see [Figure 4](#)). The recommended time is 4 hours after the drive has been unpacked or 1 hour after any condensation that you can see has evaporated, whichever is greater. To allow the drive to adjust to its new environment, apply the following measures:

- 1 If the drive is colder than its operating environment and the air contains sufficient humidity, condensation may occur in the drive and damage it. When the drive has warmed to the operating temperature range (greater than 10 degrees C or 50 degrees F) and no danger of condensation is present (the air is dry), warm the drive more quickly by powering it on for 30 minutes. Use a scratch tape to test the drive before inserting a tape that contains data.
- 1 If the drive is hotter than its operating environment, the tape can stick to the drive head. When the drive has cooled to the operating temperature range (less than 40 degrees C or 104 degrees F), cool the drive more quickly by applying airflow for 30 minutes. Power on the drive and use a scratch tape to test it before inserting a tape that contains data.

If you are uncertain about whether the temperature of the drive is within the recommended operating range or the humidity is sufficient to cause condensation, allow the drive to adjust to its new environment for the full 4 hours.

#### Figure 4. Air Intake Area

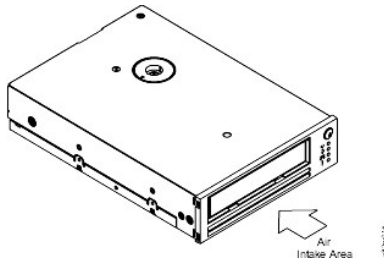

#### Step 2 — Removing Power from the System

1. Power-off the system.
2. Disconnect the power cord from both the electrical outlet and the system.

#### Step 3 — Setting the SCSI ID

Your tape drive is shipped with a default SCSI ID of 6, but it can be assigned any unused ID between 0 and 15. Do not use SCSI ID 7, which is reserved for the SCSI controller, or SCSI ID 0, which is typically assigned to the boot disk. We do not recommend installing the drive onto a narrow SCSI bus, as this will restrict performance.

- ⚠ **NOTICE:** Static electricity can damage electronic components. Always wear an antistatic wriststrap if possible. If not, to equalize the electromagnetic charges, touch a bare metal part of the computer (such as the back plate) before you remove the tape drive from its bag.

To set the SCSI ID:

1. Locate the SCSI ID connector (see number 2 in [Figure 3](#) in the Introduction. The SCSI ID is set using jumpers on a set of pins at the rear of the drive.
2. Determine whether you need to change the SCSI ID from the default of 6. Make sure the ID is not used by another device.
3. Referring to [Figure 5](#), find the ID number that you chose. Then, place jumpers on the connector pins as shown (use a pair of needle-nose pliers to connect the jumpers to the pins that are shaded).

**Figure 5. SCSI Connector Pins**

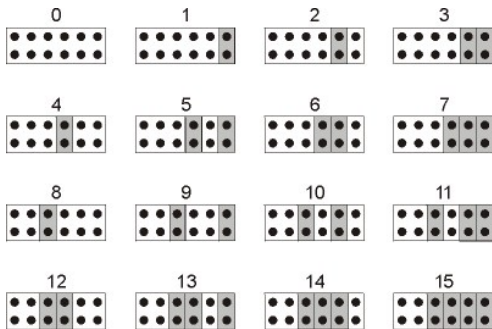

#### Step 4 — Preparing the Mounting Bay in Your System

- ⚠ **CAUTION:** To avoid personal injury or damage to the system or tape drive, ensure that the system power cord is disconnected before you install the drive.

Refer to your system's documentation for instructions on how to prepare the mounting bay to receive the tape drive.

#### Step 5 — Attaching Mounting Hardware

If your system requires special rails or other hardware to install the tape drive, mount them on the tape drive in this step.

If your system does not require special mounting hardware, proceed to step 6.

#### Step 6 — Installing the Drive

Slide the tape drive into the open bay, aligning the tray or rails with the slots in the bay, as shown in [Figure 6](#).

**Figure 6. Install the Drive**

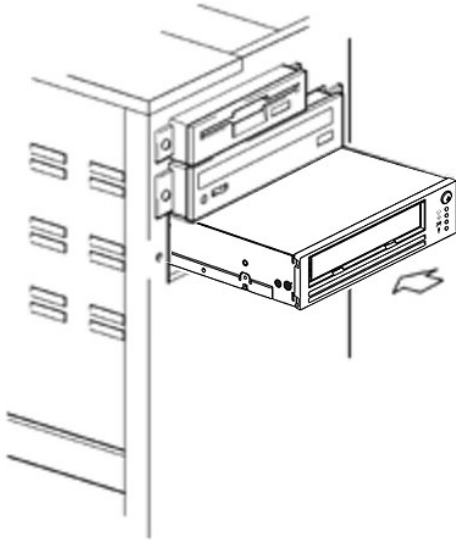

If your system does not use mounting hardware, check that the holes in the chassis are aligned with the holes in the side of the tape drive see [Figure 7](#).

**Figure 7. Mounting Holes on Tape Drive**

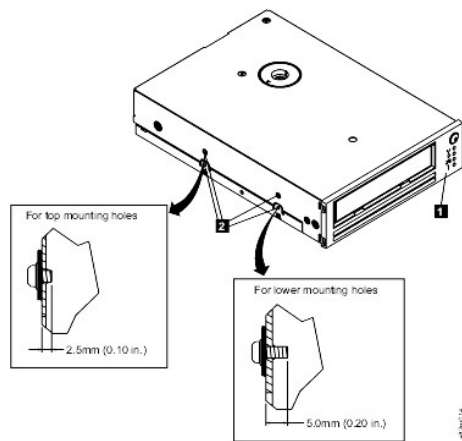

1. M-3 mounting screw holes

Do not secure the drive with screws at this point because you may have to move the drive to get the cables in place.

**Step 7 — Attaching Power and SCSI Cables**

Attach a spare power cable from the system's internal power supply to the power connector, as shown in [Figure 8](#), number 1.

Attach a spare SCSI cable on the system's SCSI ribbon cable to the SCSI connector, as shown on [Figure 8](#), number 2.

 **NOTE:** If the drive is the last device on the SCSI chain, it must be terminated.

**Figure 8. Attach Power and SCSI Cables**

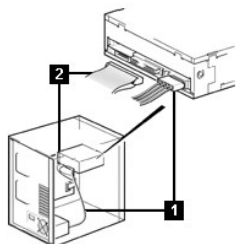

1. Power connector
2. SCSI connector

#### Step 8 — Securing the Drive

The tape drive can be mounted several ways. Ensure that you have the proper mounting rails or drive mounting sled and the correct screws (M-3). Some systems require the drive to be inserted into a media bay and attached directly to the system.

**Figure 9. Secure the Drive**

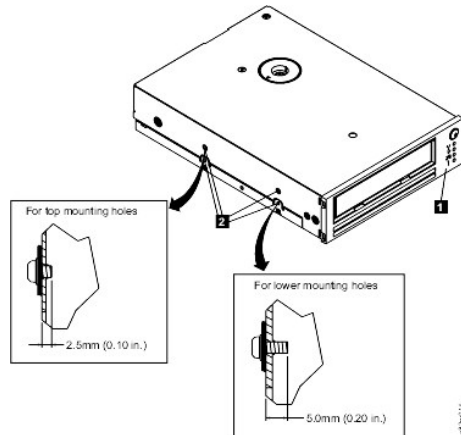

#### Step 9 — Connecting Computer Power and Testing Power to the Tape Drive

Connect the power cord to the system and to the electrical outlet. To ensure that the drive is receiving power, watch for the following while turning on the power to the system:

1. During Boot process, all four status LEDs will be on for 2.0 seconds.
2. The Ready status LED (green) will flash slowly during self-test (POST). All other LEDs will be off.
3. The Ready status LED (green) will stop flashing and turn on when POST has completed.

## Loading Device Drivers

### Microsoft Windows® 2000

This section describes how to install, remove, and disable the Microsoft Windows 2000 Device Drivers for the tape drive.

#### Installation Procedures

1. Make sure that you are logged on to the host server or workstation with Administrator privileges.
2. Insert the Dell Powervault LTO3-060 Drive Support CD into the CD-ROM drive on the host server or workstation.
3. Right-click the **My Computer** icon on the Windows desktop, click **Manage**, then click **Device Manager**. The tape drive should be listed under the **? Other Devices** item as **IBM Ultrium-HH3 SCSI Sequential Device**.
4. Right-click the **IBM Ultrium-HH3 SCSI Sequential Device** listing, click **Uninstall**, and then click **OK** to confirm that you want to remove the device.
5. Click **Action** in the upper-left corner of the **Computer Management** dialog box.
6. Click **Scan for Hardware Changes**. Windows 2000 now scans for the Dell PowerVault LTO3-060 drive. The tape drive appears under **? Other Devices** again.
7. Right-click the **IBM Ultrium-HH3 SCSI Sequential Device** listing and click **Properties**.
8. Click **Reinstall Driver**.
9. When the Upgrade Device Driver Wizard appears, click **Next**.
10. Click **Display a list ...** and then click **Next**.
11. Click the **Tape Drives** item in the list. You may have to scroll down to see this item. Click **Next**.
12. Click **Have Disk**, type `d:\Drivers\Windows 2000, 2003 32bit x86`, replacing *d:* with the drive letter for the CD-ROM drive into which you inserted the support CD, and click **OK**.
13. Click the **IBM Ultrium-HH3 LTO tape drive** entry and click **Next**.
14. Click **Next** to install the driver.
15. You may get a warning that says *Installing this driver is not recommended ...* Click **Yes** anyway.
16. Click the **Finish** button.
17. Close the **Device Properties** dialog box.
18. The drive now appears in **Device Manager** under **Tape Drives** and is ready to use.

### Microsoft Windows 2003

This section describes how to install, remove, and disable the Microsoft Windows 2003 Device Drivers for the tape drive.

## Installation Procedures

1. Make sure that you are logged on to the host server or workstation with Administrator privileges.
  2. Insert the Dell PowerVault LTO3-060 Drive Support CD into the CD drive on the host server or workstation.
  3. Right-click the **My Computer** icon on the Windows desktop, click **Manage**, then click **Device Manager**. The tape drive should be listed under the **? Other Devices** item as **IBM Ultrium-HH3 SCSI Sequential Device**.
  4. Right-click the **IBM Ultrium-HH3 SCSI Sequential Device** listing, click **Uninstall**, and then click **OK** to confirm that you want to remove the device.
  5. Right-click the topmost item in the menu structure in the right half of the **Computer Management** window. A pop-up window displays.
  6. Click **Scan for Hardware Changes**. Windows 2003 now scans for the Dell PowerVault LTO3-060 drive. (If a wizard pops up at this point, cancel the wizard. It will be used later.) The tape drive appears under **? Other Devices** again. If the tape drive is not visible, you may have to hit the plus sign ("+") in front of **? Other Devices** to make it appear.
  7. Right-click the **IBM Ultrium-HH3 SCSI Sequential Device** listing and click **Properties**.
  8. Click the **Reinstall Driver** button. (If the **Reinstall Driver** button is not visible, you may have to click the **Driver** tab, then **Update driver**.)
  9. The Upgrade Device Driver Wizard appears.
  10. Click the **Install from List or Specific Location** radio button.
  11. Click the **Next** button.
  12. Click **Include this location in the search**.
  13. Type the driver name in the directory field, replacing d: with the drive letter for the CD drive into which you inserted the support CD and click the **Next** button.  
Driver names are as follows:
    1. Windows 2003 32 bit: **d:\Drivers\Windows 2000, 2003 32bit x86\dtapeW32.inf**
    2. Windows 2003 x64: **d:\Drivers\Windows 2003 x64\dtapex64.inf**
  14. You may have to click **Continue** to bypass a warning.
  15. Click **Finish**.
  16. Close the **Device Properties** dialog box.
  17. The drive now appears in **Device Manager** under **Tape Drives** and is ready to use.
- 

## Verifying Drive Operation

Once you have installed the drive hardware, you should verify that it is functioning properly before you store your valuable data. Turn on the system. The tape drive LEDs will blink indicating that a POST (Power-on Self Test) is running to check the drive hardware:

- 1 All four LED's will be lit for 2.0 seconds
- 1 All LEDs will go off except for ready which will begin flashing slowly
- 1 The ready LED will stop flashing and turn on solid indicating that the POST has completed successfully.

Verify that the tape drive installation was successful. Following the instructions given with your Tape Backup Software application, write test data to a tape, read the test data from the tape and compare the data read from the tape with the original data on disk.

The tape drive will run its POST which checks all hardware except for the drive head. The single-character display will present a series of random characters, then become blank (not lit). The status light will briefly become solid amber, then become solid green.

Verify that the tape drive installation was successful. Following the instructions given with your Tape Backup Software application, write test data to a tape, read the test data from the tape and compare the data read from the tape with the original data on disk.

---

Please read all [restrictions and disclaimers](#).

---

[Back to Contents Page](#)



[Back to Contents Page](#)

## Using the Tape Backup Software: DELL™ PowerVault™ LTO3-060 Tape Drive User's Guide

---

See the User's Operating Guide supplied with your Tape Backup application. For the latest supported software versions, go to [support.dell.com](http://support.dell.com) or visit the support site of your backup software vendor

---

Please read all [restrictions and disclaimers](#).

---

[Back to Contents Page](#)

[Back to Contents Page](#)

## Specifications: DELL™ PowerVault™ LTO3-060 Tape Drive User's Guide

---

### General

|                |  |
|----------------|--|
| Manufacturer   | Manufactured for Dell                            |
| Model Number   | DELL PowerVault LTO3-060 Internal Tape Drive     |
| Interface Type | Ultra160 Low Voltage Differential (LVD) SCSI bus |

---

### Physical Specifications

|                              |                       |
|------------------------------|-----------------------|
| Width (without bezel)        | 146.0 mm (5.75 in.)   |
| Width (with bezel)           | 148.0 mm (5.83 in.)   |
| Length (without bezel)       | 205.5 mm (8.09 in.)   |
| Length (with bezel)          | 210.5 mm (8.29 in.)   |
| Height (without bezel)       | 41.0 mm (1.6 in.)     |
| Height (with bezel)          | 42.7 mm (1.7 in.)     |
| Weight (without a cartridge) | 1.6 kg (3 lbs. 5 oz.) |

---

### Power Requirements

|                                  |                             |
|----------------------------------|-----------------------------|
| Tolerance (+ 5 VDC and + 12 VDC) | +/- 10%                     |
| Current for 5 VDC                | 1.3 A minimum/2.8 A maximum |
| Current for 12 VDC               | 0.2 A minimum/1.1 A maximum |

---

### Typical Power Usage

|                                   |        |
|-----------------------------------|--------|
| Idle mode with no cartridge       | 10.0 W |
| Idle mode with a cartridge loaded | 12.0 W |
| Reading and writing at 4.10 m/s   | 23.5 W |

---

### Performance

|                     |   |
|---------------------|---|
| Interface           | Ultra160 LVD SCSI   |
| Recording format    | LTO Ultrium Generation 3                                      |
| Media               | LTO Ultrium   |
| Capacity            | 400 GB (native) 800 GB (compressed, assuming 2:1 compression) |
| Data transfer rate  | 60 MB/sec, Native   |
| Burst transfer rate | up to 160 MB/sec  |

---

### Operating Limits

|                              |  |
|------------------------------|--|
| Temperature                  | 10° to 40°C (50° to 104°F)                   |
| Humidity                     | 20% to 80% relative humidity (noncondensing) |
| Maximum wet bulb temperature | 26°C (78.8°F)                                |
| Maximum altitude             | 3048 m (10,000 ft)                           |

---

### Nonoperating limits (Storage)

|                              |   |
|------------------------------|---|
| Temperature                  | -40° to 65°C (-40° to 149°F)                |
| Humidity                     | 5% to 95% relative humidity (noncondensing) |
| Maximum wet bulb temperature | 40°C (95°F)                                 |

---

Please read all [restrictions and disclaimers](#).

---

[Back to Contents Page](#)

## Troubleshooting: Dell™ PowerVault™ LTO3-060 Tape Drive User's Guide

- [Obtaining Drivers and Firmware Upgrades](#)
- [Service Mode](#)
- [Working with Dumps](#)
- [Executing Service Functions](#)
- [General Guidelines](#)
- [Interpreting error conditions using status LEDs](#)
- [Methods of Receiving Errors and Messages](#)
- [Resolving Problems Reported by the System](#)
- [Resolving Media-Related Problems](#)
- [Removing a Tape Drive](#)
- [TapeAlert](#)
- [Manually Removing a Tape Cartridge](#)

### Obtaining Drivers and Firmware Upgrades

 **NOTICE:** When updating firmware, do not power off the tape drive until the update is complete, or the firmware may be lost.

Periodically check for updated levels of firmware by visiting the Web at [support.dell.com](http://support.dell.com).





### Service Mode

The tape drive can run diagnostics, and save ("dump") vital technical data to drive memory. The drive must be in service mode to perform these functions. The unload button can be used to place the drive in service mode and select a service function. To enter service mode, press the unload button and hold for 6 seconds. When the Ready LED starts to flash rapidly, then the drive is in service mode.

While in Service Mode, the drive indicates the Service Function that is to be executed by displaying one of the sequences of LEDs shown in [Table 1. Service Mode](#). When the drive is first placed in service mode, the ready LED is flashing rapidly, indicating that the drive is ready to execute service function 1. Press the button once per second to increment the service functions one by one. When you reach the desired service function, execute it by either loading a cartridge, or by double clicking the Unload button quickly. Exact instructions for executing the service functions are given in [Executing Service Functions](#).

 **NOTE:** Service functions cannot be performed concurrently with read or write operations. While in service mode, the tape drive does not accept SCSI commands from the system. Close all tape drive applications before entering service mode.

**Table 1. Service Functions**

| Service Function | Description                            | <br>Ready (green) | <br>Activity (green) | <br>Clean (amber) | <br>Fault (amber) |
|------------------|--|--|---|--|--|
| 1 <sup>1</sup>   | Standalone diagnostics (self test)     | Flashing rapidly   | OFF   | OFF  | Varies <sup>2</sup>  |
| 2                | Force dump to RAM                      | OFF  | Flashing rapidly  | OFF  | Varies <sup>2</sup>  |
| 3                | RESERVED for Trained Service Personnel | Flashing rapidly   | Flashing rapidly  | OFF  | Varies <sup>2</sup>  |
| 4                | Copy dump to flash                     | OFF  | OFF   | Flashing rapidly   | Varies <sup>2</sup>  |
| 5                | Erase flash                            | Flashing rapidly   | OFF   | Flashing rapidly   | Varies <sup>2</sup>  |
| 6                | RESERVED for Trained Service Personnel | OFF  | Flashing rapidly  | Flashing rapidly   | Varies <sup>2</sup>  |
| 7                | RESERVED for Trained Service Personnel | Flashing rapidly   | Flashing rapidly  | Flashing rapidly   | Varies <sup>2</sup>  |

|  |  |                  |    |    |                     |
|--|--|------------------|----|----|---------------------|
| 8  | RESERVED for Trained Service Personnel | Flashing rapidly | ON | ON | Varies <sup>2</sup> |
| <sup>1</sup> A blank data cartridge (scratch cartridge) is required for this function.<br><sup>2</sup> The condition of the fault light in service mode indicates the presence and location of a drive dump: <ul style="list-style-type: none"> <li>1 Off = There is no dump in Memory</li> <li>1 Flashing = Dump exists in RAM (volatile) memory</li> <li>1 Solid = Dump exists in Flash (non-volatile) memory</li> </ul> <b>Note:</b> Flash Rates: <ul style="list-style-type: none"> <li>1 Flashing slowly = 2 Hz</li> <li>1 Flashing rapidly = 8 Hz</li> </ul> |  |                  |    |    |                     |

### Working with Dumps

Saving a "dump" of diagnostic data to drive memory may be helpful in diagnosing a problem. There are two memory locations that can be used to store a dump, RAM memory and Flash memory. RAM memory is the default location for storing a dump. A dump in RAM will be overwritten when a new dump is taken. A dump in RAM will be lost if the drive is power cycled. A dump can be copied from RAM to Flash by using the service functions. When a dump has been saved in Flash, the diagnostic data is permanently saved and will not be lost during a power cycle. If there is a dump in RAM and Flash, the service mode fault light will give precedence to the dump in RAM and the light will flash. To verify the permanent dump is saved, power cycle the drive. This will erase the dump in RAM. The fault light in service mode will now be on solid, indicating a dump stored in Flash.

### Executing Service Functions

#### Executing Service Function 1: Standalone diagnostics (self test)

















Approximate run time: Less than 5 minutes

1. Ensure there is no cartridge in the drive.





**Note:**

If a cartridge is loaded in the drive, depression of the Unload button is interpreted as an unload request and the drive will ignore the second and third depressions. The drive cannot be put into Service mode while a cartridge is loaded. The test can be aborted by pressing the eject button.

2. Press and hold the Unload button until the Ready LED begins flashing rapidly indicating Service Function 1 has been accessed. The status LEDs will be in one of the following states.

| LED icon  | LED state   |   |   |
|---|---|---|---|
|   | Service Mode 1; no drive dump in memory   | Service Mode 1; drive dump in RAM   | Service Mode 1; drive dump in flash memory  |
|  |  |  |  |
|  |  |  |  |
|  |  |  |  |
|  |  |  |  |

**Key:**

-  = OFF
-  = ON
-  = Flashing slowly
-  = Flashing rapidly

**Important**

The drive will timeout if the next step is not performed within 15 seconds.

3. Insert a blank data cartridge (scratch cartridge). After a few minutes, the cartridge will unload, then load again. At the end of the self test, the drive will eject the cartridge.
  - o Refer to the chart below to determine if the test was successful or if it failed.

| LED icon | LED state       |                                       |                 |               |               |
|----------|-----------------|---------------------------------------|-----------------|---------------|---------------|
|          | Test successful | Test successful; drive needs cleaning | Incorrect media | Media failure | Drive failure |
|          | ●               | ●                                     | ●               | ●             | ●             |
|          | ●               | ●                                     | ✦               | ●             | ●             |
|          | ●               | ●                                     | ✦               | ✦             | ●             |
|          | ●               | ●                                     | ✦               | ✦             | ✦             |

Note:

- 1 If the Fault light is OFF after the test, the test was successful. If the Fault light is ON after the test, the test failed.
- 1 The Clean LED may be OFF or ON after the test, depending on whether or not the drive needs cleaning.

Key:

- = OFF
- = ON
- ✦ = Flashing slowly

4. Remove the cartridge from the drive and resume normal operations or refer to [General Guidelines](#) for help in resolving the error.

NOTE: The self test may be aborted before it has completed by pressing the Unload button. The drive will rewind the test cartridge, if necessary, unload it, and exit service mode.

**Executing Service Function 2: Force dump**

1. Ensure there is no cartridge in the drive.

**Note:**

If a cartridge is loaded in the drive, depression of the Unload button is interpreted as an unload request and the drive will ignore the second and third depressions. The drive cannot be put into Service mode while a cartridge is loaded.

2. Press and hold the Unload button until the Ready LED begins flashing rapidly indicating Service Mode 1 has been accessed. The status LEDs will be in one of the following states.

| LED icon | LED state                                   |                                       |  |
|----------|---|---------------------------------------|--|
|          | Service Function 1; no drive dump in memory | Service Function 1; drive dump in RAM | Service Function 1; drive dump in flash memory |
|          | ✦   | ✦                                     | ✦  |
|          | ●   | ●                                     | ●  |
|          | ●   | ●                                     | ●  |

|                      |   |   |   |
|----------------------|---|---|---|
| !                    | ● | ✦ | ● |
| <b>Key:</b>          |   |   |   |
| ● = OFF              |   |   |   |
| ● = ON               |   |   |   |
| ✦ = Flashing slowly  |   |   |   |
| ✨ = Flashing rapidly |   |   |   |

**Important**  
The drive will timeout if the next step is not performed within 15 seconds.

- Press the Unload Button 1 time to access Service Function 2. The status LEDs will be in one of the following states.

**Attention:** If the Fault status LED is flashing slowly, a drive dump currently exists in RAM. Be aware that you will be overwriting the drive dump in RAM. To avoid overwriting the drive dump in RAM, move the dump from RAM to flash memory (refer to [Executing Service Function 4: Copy dump to flash](#)) before proceeding to the next step.

| LED icon | Service Function 2 | Service Function 2; drive dump in RAM* | Service Function 2; drive dump in flash memory |
|----------|--------------------|--|--|
| ⌚        | ●                  | ●                                      | ●  |
| ↔        | ✨                  | ✨                                      | ✨  |
| 🔑        | ●                  | ●                                      | ●  |
| !        | ●                  | ✦                                      | ●  |

|                      |  |  |  |
|----------------------|--|--|--|
| <b>Key:</b>          |  |  |  |
| ● = OFF              |  |  |  |
| ● = ON               |  |  |  |
| ✦ = Flashing slowly  |  |  |  |
| ✨ = Flashing rapidly |  |  |  |

- Double-click the Unload button to start the service function.
- The service function is complete when all drive status LEDs go off except for Ready, which will turn on solid. This indicates that the drive has exited service mode.
- To verify that the dump is in RAM, complete the following steps.
  - Ensure there is no cartridge in the drive.
 

**Note:** If a cartridge is loaded in the drive, the Unload button is interpreted as an unload request and the drive will ignore the second and third depressions. The drive cannot be put into Service mode while a cartridge is loaded.
  - Press and hold the Unload button until the Ready LED begins flashing rapidly indicating Service Function 1 has been accessed. The status LEDs will be in the following states.

| LED icon | Service Function 1; drive dump in RAM* |
|----------|--|
| ⌚        | ✨                                      |
| ↔        | ●                                      |

|  |  |
|--|--|
|  |  |
|  |  |
| <b>Key:</b>                                      |  |
| = OFF<br>= Flashing slowly<br>= Flashing rapidly |  |

- c. Verify that the Fault LED is flashing.
  - n If the Fault LED is flashing, then the dump is in RAM.
  - n If the Fault LED is not flashing, repeat the Service Function 2 procedure.
- d. Press the Unload button once per second until you exit from Service mode and the Ready light comes ON solid.

**Executing Service Function 3: Reserved for trained service personnel**

**Executing Service Function 4: Copy dump to flash**

1. Ensure there is no cartridge in the drive.

**Note:**

If a cartridge is loaded in the drive, depression of the Unload button is interpreted as an unload request and the drive will ignore the second and third depressions. The drive cannot be put into Service mode while a cartridge is loaded.

2. Press and hold the Unload button until the Ready LED begins flashing rapidly indicating Service Function 1 has been accessed. The status LEDs will be in one of the following states.

| LED icon   | LED state                                   |                                       |  |
|--|---|---------------------------------------|--|
|  | Service Function 1; no drive dump in memory | Service Function 1; drive dump in RAM | Service Function 1; drive dump in flash memory |
|  |   |                                       |  |
|  |   |                                       |  |
|  |   |                                       |  |
|  |   |                                       |  |
| <b>Key:</b>  |   |                                       |  |
| = OFF<br>= ON<br>= Flashing slowly<br>= Flashing rapidly |   |                                       |  |

**Important**

The drive will timeout if the next step is not performed within 15 seconds.

NOTE: You can only copy dump to flash if there is a dump in RAM.

3. Press the Unload button 3 times to access Service Function 4. The status LEDs will be in one of the following states.

| LED icon | Service Function 4 | Service Function 4; drive dump in RAM* | Service Function 4; drive dump in flash memory |
|----------|--------------------|--|--|
|----------|--------------------|--|--|

|   |  |  |  |
|---|--|--|--|
|   |  |  |  |
|   |  |  |  |
|   |  |  |  |
|   |  |  |  |
| <b>Key:</b><br>= OFF<br>= ON<br>= Flashing slowly<br>= Flashing rapidly |  |  |  |

4. Double-click the Unload button to activate the service function.
5. The service function is complete when all drive status LEDs go off except for Ready, which will turn on solid. This indicates that the drive has exited service mode.
6. To verify that the dump is in flash memory, complete the following steps.
  - a. Ensure there is no cartridge in the drive.

**Note:**

If a cartridge is loaded in the drive, the Unload button is interpreted as an unload request and the drive will ignore the second and third depressions. The drive cannot be put into Service mode while a cartridge is loaded.

- b. Press and hold the Unload button until the Ready LED begins flashing rapidly indicating Service Function 1 has been accessed. The status LEDs will be in the following states.

| LED icon   | Service Function 1; drive dump in flash memory |
|--|--|
|  |  |
|  |  |
|  |  |
|  |  |
| <b>Key:</b><br>= OFF<br>= ON<br>= Flashing rapidly |  |

- c. Verify that the Fault LED is solid ON.
  - n If the Fault LED is solid ON, then the dump is in flash memory.
  - n If the Fault LED is not solid ON, repeat the Service Function 4 procedure.
- d. Press the Unload button once per second until you exit from Service mode and the Ready light comes ON solid.

**Executing Service Function 5: Erase flash**



















1. Ensure there is no cartridge in the drive.





**Note:**

If a cartridge is loaded in the drive, depression of the Unload button is interpreted as an unload request and the drive will ignore the second and third depressions. The drive cannot be put into Service mode while a cartridge is loaded.

2. Press and hold the Unload button until the Ready LED begins flashing rapidly indicating Service Function 1 has been accessed. The status LEDs will be in one of the following states.

| LED icon  | LED state   |   |   |
|---|---|---|---|
|   | Service Function 1; no drive dump in memory                                       | Service Function 1; drive dump in RAM   | Service Function 1; drive dump in flash memory                                      |
|  |  |  |  |
|  |  |  |  |
|  |  |  |  |
|  |  |  |  |

















**Key:**

-  = OFF
-  = ON
-  = Flashing slowly
-  = Flashing rapidly





**Important**

The drive will timeout if the next step is not performed within 15 seconds.

3. Press the Unload button 4 times to access Service Function 5. The status LEDs will be in one of the following states.

| LED icon  | LED state   |   |   |
|---|---|---|---|
|   | Service Function 5  | Service Function 5; drive dump in RAM   | Service Function 5; drive dump in flash memory  |
|  |  |  |  |
|  |  |  |  |
|  |  |  |  |
|  |  |  |  |

**Key:**















-  = OFF
-  = ON
-  = Flashing slowly
-  = Flashing rapidly

4. Double-click the Unload button to activate the service function.
5. The service function is complete when all drive status LEDs go off except for Ready, which will turn on solid. This indicates that the drive has exited service mode.
6. To verify that the flash memory was erased, complete the following steps.
  - a. Ensure there is no cartridge in the drive.

**Note:**

If a cartridge is loaded in the drive, the Unload button is interpreted as an unload request and the drive will ignore the second and third depressions. The drive cannot be put into Service mode while a cartridge is loaded.

- b. Press and hold the Unload button until the Ready LED begins flashing rapidly indicating Service Function 1 has been accessed. The status LEDs will be in the following states.

| LED icon  | Service Function 1; with no dump  | Service Function 1; dump in RAM   |
|---|---|---|
|    |  |  |
|    |  |  |
|    |  |  |
|    |  |  |
| <b>Key:</b><br> = OFF<br> = Flashing slowly<br> = Flashing rapidly |   |   |

- c. Verify that the Fault LED is OFF.
  - n If the Fault LED is OFF, then the flash memory has been erased.
  - n If the Fault LED is solid ON, repeat the Service Function 4 procedure to erase the flash memory.
- d. Press the Unload button once per second until you exit from Service mode and the Ready light comes ON solid.

**Executing Service Function 6: Reserved for trained service personnel**

**Executing Service Function 7: Reserved for trained service personnel**

**Executing Service Function 8: Reserved for trained service personnel**

**General Guidelines**

If you encounter problems when running the Dell PowerVault LTO3-060 Tape Drive, refer to Table 2 for common problems. If the problem is not identified, refer to ["Methods of Receiving Errors and Messages."](#) The condition of the status light can also give information about the nature of the problem. Refer to [Interpreting error conditions using Status LEDs \(Error Conditions\)](#) for more information.

**Table 2. General Troubleshooting**





| If the problem is this....   | Do this....   |
|--|---|
| The Fault LED is flashing slowly.                                    | This indicates one of the following failures has occurred: <ol style="list-style-type: none"> <li>1 Unrecoverable drive failure (see <a href="#">Removing a Tape Drive</a>)</li> <li>1 Firmware upgrade failure - Retry the firmware upgrade. If it still fails, see <a href="#">Removing a Tape Drive</a>).</li> </ol> |
| The Fault LED is solid ON.   | This indicates that the drive has reached its maximum operating temperature. Power OFF the drive until the temperature of the drive has returned to the normal operating temperature range (see <a href="#">Specifications</a> ).   |
| The Activity LED, Clean LED, and Fault LEDs are all flashing slowly. | This indicates that incorrect media has been inserted into the drive. If the drive does not eject the cartridge press the Unload button to eject the cartridge from the drive and replace with the correct media (see <a href="#">Loading, Unloading and Write-Protecting Cartridges</a> ).                             |
| The Clean and Fault LEDs are flashing slowly.                        | This indicates a media failure. Press the Unload button to eject the cartridge from the drive. Remove the cartridge from the drive and inspect it for damage and debris. Verify that the Write-Protect Switch on the cartridge is in the unlocked position (see <a href="#">Write-protect switch</a> ).                 |
| The LEDs never turn ON.  | The drive has no power. Check the power at the power source. Connect power to the drive (see <a href="#">Step 9</a> —   |

|   |  |
|---|--|
|   | <a href="#">Connecting Computer Power and Testing Power to the Tape Drive</a> ). If the problem persists, replace the drive.   |
| The drive will not load a tape cartridge.   | <p>One of the following has occurred:</p> <ul style="list-style-type: none"> <li>1 A tape cartridge is already inserted. To remove the cartridge, press the Unload button. If the cartridge does not eject, turn off the power to the drive, then turn it back on. After the Ready LED (  ) becomes solid ON, press the Unload button to eject the cartridge.</li> <li>1 The tape cartridge was inserted incorrectly. To properly insert a cartridge, see <a href="#">Loading a Tape Cartridge</a>.</li> <li>1 The tape cartridge may be defective. Insert another tape cartridge. If the problem exists for multiple cartridges, the drive is defective. Replace the defective drive with a new drive.</li> <li>1 The drive has no power. Connect power to the drive (see <a href="#">Connect and test power to the drive</a>).</li> </ul> |
| The drive will not unload the tape cartridge.   | The tape cartridge is stuck or is broken. Press the Unload button. If the cartridge does not eject, reset the drive by holding down on the Unload button for 12 seconds. The drive will save a dump to RAM, reboot, and then rewind the cartridge back to the beginning of tape. This could take up to 10 minutes if the cartridge was out at the end. When the cartridge is positioned back at the beginning, hit the Unload button again to eject the cartridge. See <a href="#">Manually Removing a Tape Cartridge</a> for more details. If the cartridge still does not eject, turn off the power to the drive, then turn it back on. This will start the same sequence as a reset. Follow the same process as the reset. If the cartridge still will not eject, contact your customer support resource.   |
| SCSI log sense data (such as TapeAlert flags) at the server console.                          | See <a href="#">TapeAlert flags</a> .  |
| The server reported SCSI problems (such as selection or command time-outs, or parity errors). | See <a href="#">Resolving Problems Reported by the System</a> .  |
| The drive does not respond to server commands.  | Press and hold the Unload button on the drive for 12 seconds to force a drive dump. The drive will save the dump and then reboot to allow communication to the drive to occur. Do not cycle power, as this will erase the contents of the dump.  |

### Interpreting error conditions using status LEDs

The table below gives information on interpreting the status LEDs when the drive is in Operation mode and there is an error. For interpretation of LED states when there is no error present, see the Introduction section, table 2, [Interpretation of status LEDs in Operation mode \(No Errors\)](#) for more information.

**Table 3. Interpretation of status LEDs in Operation mode (Error Conditions)**

| LED icon  | Cleaning cartridge loaded, cleaning failed | Unrecoverable drive failure <sup>2</sup> , no cartridge in drive | Unrecoverable drive failure <sup>2</sup> , cartridge in drive | Unrecoverable drive failure <sup>2</sup> , no cartridge in drive; drive needs cleaning <sup>1</sup> | Unrecoverable drive failure <sup>2</sup> , cartridge in drive; drive needs cleaning <sup>1</sup> | Firmware download / upgrade failure | Firmware download / upgrade failure; drive needs cleaning <sup>1</sup> | Maximum operating temperature exceeded <sup>3</sup> | Maximum operating temperature exceeded <sup>3</sup> ; drive needs cleaning <sup>1</sup> | Media failure | Incorrect media inserted in drive |
|---|--|--|---|---|--|-------------------------------------|--|---|---|---------------|-----------------------------------|
|  | ●  | ●  | ●   | ●   | ●  | ⚡                                   | ⚡  | ●   | ●   | ●             | ●                                 |
|  | ●  | ●  | ●   | ●   | ●  | ⚡                                   | ⚡  | ●   | ●   | ●             | ⚡                                 |
|  | ●  | ●  | ●   | ●   | ●  | ●                                   | ●  | ●   | ●   | ⚡             | ⚡                                 |
|  | ●  | ⚡  | ⚡   | ⚡   | ⚡  | ⚡                                   | ⚡  | ●   | ●   | ⚡             | ⚡                                 |

<sup>1</sup> A solid amber Clean LED indicates that the drive needs cleaning. In most cases the drive will continue to function, but it should be cleaned as soon as possible.

<sup>2</sup> The Fault LED will flash to indicate an unrecoverable error. An unrecoverable error is an error condition that results in the drive not being able to function unless initiator, operator, or service intervention is applied. An unrecoverable cartridge (media) failure is usually the result of a defective cartridge, media, or cartridge state and will require the drive to eject the cartridge (if possible) to clear the flashing LED. An unrecoverable drive failure is usually the result of a hardware error condition. One of the following actions will be needed to clear the flashing "Fault" LED.

- 1 Perform Cartridge Emergency Eject function (see [Table 1](#)).
- 1 Power cycle the drive.
- 1 Retry firmware download.

If none of these actions corrects the problem, contact your customer support resource.

<sup>3</sup> The Fault LED must be solid ON to indicate an over temperature condition. If a tape is present, it will be ejected. This LED will remain on until drive temperature drops below a secondary temperature limit, and one of the following two conditions is met:

- 1 a data or cleaning cartridge is inserted
- 1 a power cycle occurs

**Key:**

 = OFF

 = ON

 = Flashing slowly

### Methods of Receiving Errors and Messages

If you receive an error message from the drive, a library or autoloader that includes the drive or a system application that is using the drive, use [Table 3](#) as a cross reference to find the meaning of the error.

 **NOTE:** The drive status LEDs have different meanings when the drive is in operation mode vs. when the drive is in service mode. LED states that occur during operation mode are defined in two separate charts. If the drive has no errors, the LED states are defined in "[Table 2. Interpretation of status LEDs in Operation mode \(No Errors\)](#)" in the Introduction." If there is an error, LED states are defined in "[Table 3. Interpretation of status LEDs in Operation mode \(Error Conditions\)](#)". LED states that occur when the drive is in service mode are defined in [Service Mode](#).

**Table 4. Methods of Receiving Errors and Messages**

| If the error or message was presented by...                                     | Do this....   |
|---|---|
| The system's display (if the tape drive is enclosed in a library or autoloader) | Refer to the documentation for the system.  |
| The tape drive's status LEDs indicate a problem                                 | See " <a href="#">General Guidelines</a> ." To determine the meaning of status light activity, see the Front Panel section in the " <a href="#">Introduction</a> ." |
| SCSI log sense data (such as TapeAlert flags) or SCSI drive sense data          | See " <a href="#">TapeAlert Flags</a> ."  |

### Resolving Problems Reported by the System

The procedure for fixing SCSI bus errors varies, depending on whether the error is consistent or intermittent, and whether your configuration contains single or multiple tape drives. The sections that follow describe how to fix each type of error.

#### Fixing a Consistent Error with a Single Drive on a SCSI Bus

1. Ensure that the power is on to the tape drive.
2. Ensure that the tape drive's SCSI address is the same as the SCSI address assigned by the system.
3. Replace the SCSI terminator and retry the failing operation.
4. Replace the SCSI cable and interposers, if any, and retry the failing operation
5. If these measures do not correct the problem, contact Dell customer support.

#### Fixing a Consistent Error with Multiple Drives on a SCSI Bus

When a consistent error occurs in a configuration that has multiple tape drives on the SCSI bus, you must determine if the problem exists with more than one tape drive. If the problem is with all of the devices on the SCSI bus, the bus is stuck in a SCSI phase and cannot change to another phase or the SCSI cable from the system to the first device is defective.

1. Ensure that the SCSI cable from the system to the first device is connected.
2. Disconnect all but the first tape drive on the SCSI bus. Move the terminator to the first SCSI device.
3. Run an application to determine whether the error will occur.
  - o If the error occurs, do the following:
    - n Replace the SCSI terminator and retry the failing operation.
    - n Replace the SCSI cable and interposers, if any, and retry the failing operation.
    - n If these measures do not correct the problem, contact Dell technical support.
  - o If the error does not occur, connect one tape drive at a time back to the bus and repeat step 3 for each tape drive until you can identify which drive is defective.

 **NOTE:** Ensure that the SCSI terminator is always on the last tape drive on the SCSI bus.

4. Determine if the problem is with only one tape drive or with two or more tape drives.

- If the problem is with only one tape drive, do the following:
  - Replace the SCSI terminator and retry the failing operation.
  - Replace the SCSI cable and interposers, if any, and retry the failing operation.
  - If these measures do not correct the problem, contact Dell technical support.
- If the problem is with two or more tape drives, locate the first tape drive that has the error and replace the SCSI cable that connects the tape drive and the interposer (if installed).

#### Fixing an Intermittent Error with a Single Drive on a SCSI Bus

1. Replace the SCSI terminator on the tape drive.
2. Run the operation that caused the error. If the problem persists, the problem may be with the cable.
3. Isolate which cable is causing the problem by replacing one cable at a time and running the operation that caused the error after each replacement.
4. If the problem persists, contact Dell technical support.

#### Fixing an Intermittent Error With Multiples Drives on a SCSI Bus

Refer to the system's error logs to determine which tape drive is the source of the problem:

1. If only one tape drive is reporting a SCSI failure, contact Dell technical support.
1. If multiple tape drives are reporting SCSI failures, the problem may be with the terminator or the SCSI cables:
  - Replace the terminator and run the operation that caused the error. If the problem persists, the problem may be with the cables.
  - Isolate which cable is causing the problem by replacing one cable at a time and run the operation that caused the error after each replacement.

## Resolving Media-Related Problems

The tape drive has the capability to determine if a cartridge is faulty. A faulty cartridge will be reported as a TapeAlert flag (see "[TapeAlert Flags](#)") and the clean LED will flash slowly (2 Hz rate).

1. If the operation in the other drive fails, replace the media.
1. If the operation succeeds, see [Executing Service Function 1: Standalone diagnostics \(self test\)](#).

## Removing a Tape Drive

To remove the tape drive from the system, perform the following steps:

1. Ensure that the tape drive does not contain a tape cartridge.
2. Deconfigure the drive from the system (for instructions, see your system's documentation).
3. Turn off the power to the system. Disconnect the power cable from the system and the electrical outlet.
4. Remove system cover.
5. Disconnect the internal power cable from the power connector (see number 3 in [Figure 14](#)).
6. Disconnect the internal SCSI ID cable from the SCSI ID connector (see number 2 in [Figure 14](#)).
7. Disconnect the internal SCSI cable from the SCSI connector (see number 1 in [Figure 14](#)).
8. Remove the tape drive from the system and remove any mounting screws or rails from the side or bottom of the tape drive.
9. To reassemble, reverse these steps.

**Figure 14. Half-high SCSI drive rear panel element descriptions**

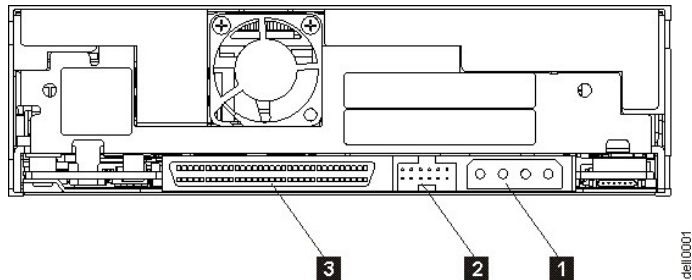

1. Power connector
2. SCSI ID connector
3. SCSI connector

## TapeAlert

TapeAlert is a patented technology and standard of the American National Standards Institute (ANSI) that defines conditions and problems that are experienced by tape drives. The technology enables a system to read TapeAlert flags from a tape drive through the SCSI interface. The system reads the flags from Log Sense Page

0x2E. TapeAlert flags may appear as messages on the application screen or in the application error logs.

### TapeAlert Flags

Table 5 lists the TapeAlert flags that are supported by the Dell PowerVault LTO3-060 Tape Drive.

**Table 5. TapeAlert Flags and Descriptions**

| TapeAlert Flags Supported by the Tape Drive |                         |  |  |  |
|---|-------------------------|--|--|--|
| Flag Number                                 | Flag Parameter (in hex) | Flag   | Description  | Action Required  |
| 3   | 03h                     | Hard error                                       | Set for any unrecoverable read, write, or positioning error. (This flag is set in conjunction with flags 4, 5, or 6.)  | See the Action Required column for Flag 4, 5, or 6 in this table.  |
| 4   | 04h                     | Media  | Set for any unrecoverable read, write, or positioning error that is due to a faulty tape cartridge.  | The Cartridge is defective. Contact Dell technical support.  |
| 5   | 05h                     | Read failure                                     | Set for any unrecoverable read error where isolation is uncertain and failure could be due to a faulty tape cartridge or to faulty drive hardware.                 | If Flag 4 is also set, the cartridge is defective. Contact Dell technical support. If Flag 4 is not set, see " <a href="#">General Guidelines</a> " in the troubleshooting section of this manual.   |
| 6   | 06h                     | Write failure                                    | Set for any unrecoverable write or positioning error where isolation is uncertain and failure could be due to a faulty tape cartridge or to faulty drive hardware. | If Flag 9 is also set, make sure that the write-protect switch is set so that data can be written to the tape (see " <a href="#">Setting the Write-Protect Switch</a> "). If Flag 4 is also set, the cartridge is defective. Replace the tape cartridge. If Flag 4 is not set, see " <a href="#">General Guidelines</a> " in the troubleshooting section of this manual. |
| 8   | 08h                     | Not data grade                                   | Set when severe servo errors occur while loading a tape cartridge.   | Replace the tape cartridge. If this error occurs with multiple tapes, see " <a href="#">General Guidelines</a> " in the troubleshooting section of this manual.  |
| 9   | 09h                     | Write protect                                    | Set when the tape drive detects that the tape cartridge is write-protected.  | Make sure that the cartridge's write-protect switch is set so that the tape drive can write data to the tape " <a href="#">Setting the Write-Protect Switch</a> " section.   |
| 10  | 0Ah                     | No removal                                       | Set when the tape drive receives an UNLOAD command after the system prevented the tape cartridge from being removed.   | Refer to the documentation for your system's operating system.   |
| 11  | 0Bh                     | Cleaning media                                   | Set when you load a cleaning cartridge into the drive.   | No action required.  |
| 12  | 0Ch                     | Unsupported format                               | Set when you load an unsupported cartridge type into the drive or when the cartridge format has been corrupted.  | Use a supported tape cartridge.  |
| 15  | 0Fh                     | Cartridge memory chip failure                    | Set when a cartridge memory (CM) failure is detected on the loaded tape cartridge.   | Replace the cartridge. If this error occurs on multiple tapes, see " <a href="#">General Guidelines</a> " in the troubleshooting section of this manual.   |
| 16  | 10h                     | Forced eject                                     | Set when you manually unload the tape cartridge while the drive was reading or writing.  | No action required.  |
| 18  | 12h                     | Tape directory corrupted in the cartridge memory | Set when the drive detects that the tape directory in the cartridge memory has been corrupted.   | Reread all data from the tape to rebuild the tape directory.   |
| 20  | 14h                     | Clean now  | Set when the tape drive detects that it needs cleaning.  | Clean the tape drive. See the " <a href="#">Cleaning the Tape Mechanism</a> " section."  |
| 21  | 15h                     | Clean periodic                                   | Set when the drive detects that it needs routine cleaning.   | Clean the tape drive as soon as possible. The drive can continue to operate, but you should clean the drive soon. See the " <a href="#">Cleaning the Tape Mechanism</a> " section."  |
| 22  | 16h                     | Expired clean                                    | Set when the tape drive detects a cleaning cartridge that has expired.   | Replace the cleaning cartridge.  |
| 23  | 17h                     | Invalid cleaning tape                            | Set when the drive expects a cleaning cartridge and the loaded cartridge is not a cleaning cartridge.  | Use a valid cleaning cartridge.  |
| 30  | 1Eh                     | Hardware A                                       | Set when a hardware failure occurs that requires that you reset the tape drive to recover.   | Reset the tape drive. See " <a href="#">Resetting the drive</a> ". If resetting the drive does not recover the error, see " <a href="#">General Guidelines</a> " in the troubleshooting section of this manual.  |

|    |     |                                  |  |   |
|----|-----|----------------------------------|--|---|
| 31 | 1Fh | Hardware B                       | Set when the tape drive fails its internal self tests.   | Contact Dell support.   |
| 32 | 20h | Interface                        | Set when the tape drive detects a problem with the SCSI interface.   | Refer to " <a href="#">Resolving Problems Reported by the System</a> ."   |
| 33 | 21h | Eject media                      | Set when a failure occurs that requires you to unload the cartridge from the drive.  | Unload and reload the tape cartridge.   |
| 34 | 22h | Download fail                    | Set when a field microcode replacement (FMR) image is unsuccessfully downloaded to the tape drive via the SCSI interface.  | Ensure that it is the correct image. Download the FMR image again.  |
| 36 | 24h | Drive temperature                | Set when the drive's temperature sensor indicates that the drive's temperature is exceeding the recommended temperature of the system (see " <a href="#">Specifications</a> ").                  | See " <a href="#">General Guidelines</a> " in the troubleshooting section of this manual  |
| 37 | 25h | Drive voltage                    | Set when the drive detects that the externally supplied voltages are either approaching the specified voltage limits or are outside the voltage limits (see " <a href="#">Specifications</a> "). | See " <a href="#">Step 7. Attaching Power and SCSI Cables</a> " in the "Setting up the Tape Drive" section of this manual. If that does not resolve the problem, contact Dell Technical Support.  |
| 39 | 27h | Diagnostics required             | Set when the drive detects a failure that requires diagnostics to isolate the problem.   | See " <a href="#">General Guidelines</a> " in the troubleshooting section of this manual.   |
| 51 | 33h | Tape directory invalid at unload | Set when the tape directory on the tape cartridge that was previously unloaded is corrupted. The file-search performance is degraded.  | Rebuild the tape directory by reading all the data.   |
| 52 | 34h | Tape system area write failure   | Set when the tape cartridge that was previously unloaded could not write its system area successfully.   | Copy the data to another tape cartridge, then discard the old cartridge.  |
| 53 | 35h | Tape system area read failure    | Set when the tape system area could not be read successfully at load time.   | Copy the data to another tape cartridge, then discard the old cartridge.  |
| 55 | 37h | Loading failure                  | The drive is unable to load the media and thread the tape.   | Remove the cartridge. Inspect it as specified in " <a href="#">Perform a Thorough Inspection</a> " in this manual. Retry the load operation. If the problem persists, try another cartridge. If the problem persists, contact Dell Technical Support. |
| 56 | 38h | Unrecoverable unload failure     | The drive is unable to unload the media.   | See " <a href="#">General Guidelines</a> " in the troubleshooting section of this manual.   |

## Manually Removing a Tape Cartridge

If problem-determination procedures identify the tape drive as the source of the problem and you are unable to eject the tape cartridge using the eject button, reset the drive to recover the cartridge:

1. Press and hold the eject button for 12 seconds, then release.
  - o The drive will save (dump) diagnostic information into drive RAM memory.
  - o The drive will reboot and start through its power-on self test (POST) process.
    - n All 4 LEDs will light for 2 seconds
    - n The Ready LED will start blinking slowly.
    - n POST is complete when the ready LED stops blinking and turns solid.
  - o The drive slowly rewinds the tape cartridge back to the beginning of tape and positions it for use.
    - n The Activity LED flashes while the cartridge rewinds and repositions.
    - n The Ready LED remains on during rewind and reposition.
  - o When the Activity LED turns off, leaving the Ready LED still on solid, the tape drive is ready for use.
    -  NOTE: Allow at least 10 minutes for the rewind process to complete.
2. To eject the cartridge, push the eject button one more time. If the tape cartridge still will not eject, contact Dell Technical Support for assistance.

 NOTICE: If you are not a trained service person, do not attempt to open the drive for repairs as this will void your warranty.

Please read all [restrictions and disclaimers](#).

[Back to Contents Page](#)





## Using the Tape Drive: DELL™ PowerVault™ LTO3-060 Tape Drive User's Guide

- [Operating the Drive](#)
  - [Loading, Unloading and Write-Protecting Cartridges](#)
  - [Caring for Tape Cartridges](#)
  - [Cleaning the Tape Mechanism](#)
- 

### Operating the Drive

The tape drive will come on when the system is powered on. The tape drive will run its Power-On Self-Test (POST). At the end of the hardware self-test, the Ready LED should be solid green.

### Resetting the Drive

You can reset the drive without powering off the drive and system. This may be necessary if the drive stops responding. To do this, press and hold the eject button on the front panel of the tape drive for 12 seconds (see number 1 in [Figure 2](#)). The drive forces a dump of vital technical data to drive RAM memory and overwrites the existing dump. The drive then reboots to allow communication. If there is a cartridge loaded, the drive will slowly rewind it back to the beginning of tape and reposition it for use. This may take up to 10 minutes to complete. To eject the cartridge, push the Unload button one more time.

**Figure 10. Half-high Drive**

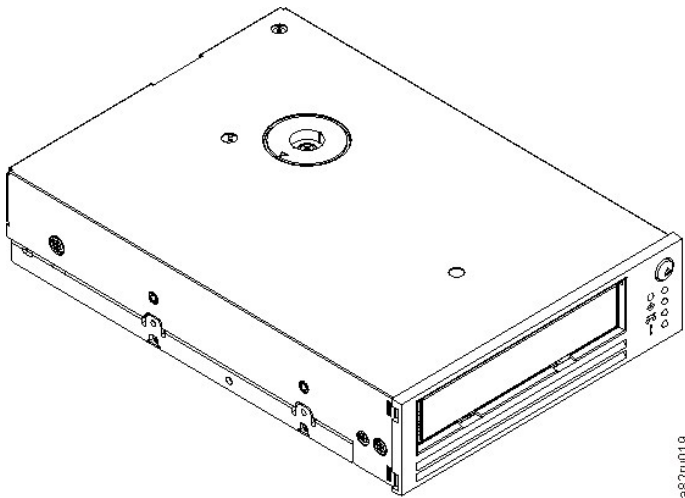

### Loading, Unloading, and Write-Protecting Cartridges

Only use LTO Ultrium format cartridges with your drive, as specified in the LTO Ultrium standard. Ensure that only one label is stuck to the label area of the cartridge. Never use nonstandard labels, and never stick anything to the cartridge other than in the label area.

The tape drive uses the following cartridge types:

- 1 LTO Ultrium 100-GB Data Cartridge (Generation 1)
  - 1 LTO Ultrium 200-GB Data Cartridge (Generation 2)
  - 1 LTO Ultrium 400-GB Data Cartridge (Generation 3)
  - 1 LTO Ultrium Universal Cleaning Cartridge
  - 1 LTO Ultrium 400-GB WORM Data Cartridge (Generation 3) (with write once read many (WORM) firmware)
- NOTE: An LTO WORM cartridge can be written and appended but cannot be erased or overwritten.

Cartridge compatibility for the LTO3-060 tape drive is as follows:

- 1 Reads and writes Generation 3 format from Generation 3 cartridges.
- 1 Reads and writes Generation 2 format from Generation 2 cartridges.
- 1 Reads Generation 1 format from Generation 1 cartridges.
- 1 Does not write Generation 3 format on Generation 2 cartridges.
- 1 Does not reformat Generation 2 cartridges to Generation 3 format.

[Figure 11](#) shows the LTO Ultrium 400-GB Data Cartridge and its components.

**Figure 11. LTO Ultrium 400-GB Data Cartridge**

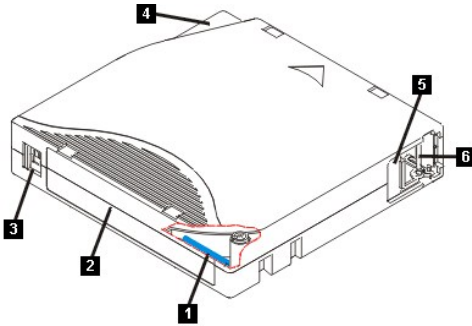

1. LTO cartridge memory
2. Label area
3. Write-protect switch
4. Insertion guide
5. Cartridge door
6. Leader pin

---

### Loading a Tape Cartridge

1. Ensure that the tape drive is powered on (the Ready light is solid green).
2. Ensure that the write-protect switch (see number 3 in [Figure 11](#)) is properly set. (See "[Setting the Write-Protect Switch on Cartridges](#)").
3. Grasp the cartridge so that the write-protect switch faces you.
4. Slide the cartridge into the tape load compartment (see [Figure 12](#)).
  - o If the cartridge is already in the ejected position and you want to reinsert it, remove the cartridge and then insert it again.
  - o If the cartridge is already loaded and you cycle the power (turn it off, then on), the tape will rewind to the beginning and position itself ready for use.

**Figure 12. Loading**

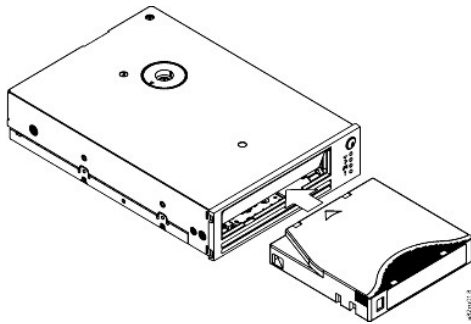

### Unloading a Tape Cartridge

1. Ensure that the tape drive is powered on (the Ready light is solid green).
2. Press the eject button (see number 1 in [Figure 2](#)). The drive rewinds the tape and partially ejects the cartridge. The Activity light flashes green while the tape rewinds, then goes out before the cartridge partially ejects.
3. After the cartridge partially ejects, grasp the cartridge and remove it.

Whenever you unload a tape cartridge, the tape drive writes any pertinent information to the cartridge memory.

➡ NOTICE: Do not remove a tape cartridge while the drive activity LED is on.

### Setting the Write-Protect Switch on Tape Cartridges

➡ NOTICE: Write-protection will not prevent a cartridge from being erased or degaussed. Do not bulk erase Ultrium format cartridges. This will destroy prerecorded server information and render the cartridge unusable. Always use the long or quick erase command in your backup software to erase cartridges.

The position of the write-protect switch (number 1 in [Figure 13](#)) on the tape cartridge determines whether you can write to the tape:

- 1 If the switch is set to locked (locked padlock), data cannot be written to the tape.
- 1 If the switch is set to unlocked (unlocked padlock or black void), data can be written to the tape.

**Figure 13. Setting the Write-Protect Switch**

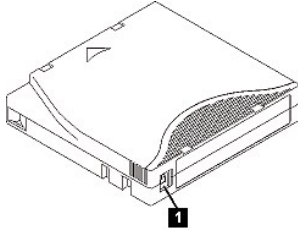

To set the switch, slide it left or right to the desired position. If you slide the red tab after the cartridge is inserted in the drive, the change will not take effect until the cartridge is removed and reinserted.

### Caring for Tape Cartridges

- ➔ **NOTICE:** Do not insert a damaged tape cartridge into your tape drive. A damaged cartridge can interfere with the reliability of the drive and may void the warranties of the drive and the cartridge. Before inserting a tape cartridge, inspect the cartridge case, cartridge door, and write-protect switch for breaks.

Incorrect handling or an incorrect environment can damage the LTO Ultrium Tape Cartridge or its magnetic tape. To avoid damage to your tape cartridges and to ensure the continued high reliability of your tape drive, use the following guidelines.

#### Provide Training

- 1 Post procedures that describe proper media handling in places where people gather.
- 1 Ensure that anyone who handles tape has been properly trained in handling and shipping procedures. This includes operators, users, programmers, archival services, and shipping personnel.
- 1 Ensure that any service or contract personnel who perform archiving are properly trained in media-handling procedures.
- 1 Include media-handling procedures as part of any services contract.
- 1 Define and make personnel aware of data recovery procedures.

#### Ensure Proper Packaging

- 1 When you ship a cartridge, ship it in its original or better packaging.
- 1 Always ship or store a cartridge in a jewel case.
- 1 Use only a recommended shipping container that securely holds the cartridge in its jewel case during transportation.
- 1 Never ship a cartridge in a commercial shipping envelope. Always place it in a box or package.
- 1 If you ship the cartridge in a cardboard box or a box of a sturdy material, ensure the following:
  - o Place the cartridge in polyethylene plastic wrap or bags to protect it from dust, moisture, and other contaminants.
  - o Pack the cartridge snugly; do not allow it to move around.
  - o Double-box the cartridge (place it inside a box, then place that box inside the shipping box) and add padding between the two boxes

#### Provide Proper Acclimation and Environmental Conditions

- 1 Before you use a cartridge, let it acclimate to the normal operating environment for 1 hour. If you see condensation on the cartridge, wait an additional hour.
- 1 Ensure that all surfaces of a cartridge are dry before inserting it.
- 1 Do not expose the cartridge to moisture or direct sunlight.
- 1 Do not expose recorded or blank cartridges to stray magnetic fields of greater than 100 oersteds (for example, terminals, motors, video equipment, X-ray equipment, or fields that exist near high-current cables or power supplies). Such exposure can cause the loss of recorded data or make the blank cartridge unusable.
- 1 Maintain the following environmental conditions outlined in the [Table 1](#).

**Table 1. Environmental Specifications**

| Environmental Factor              | Operating                     | Operational Storage <sup>1</sup> | Archival Storage <sup>2</sup> | Shipping                       |
|-----------------------------------|-------------------------------|----------------------------------|-------------------------------|--------------------------------|
| Temperature                       | 10° to 45°C<br>(50° to 113°F) | 16° to 35°C<br>(61° to 95°F)     | 16° to 25°C<br>(61° to 77°F)  | -23° to 49°C<br>(-9° to 120°F) |
| Relative humidity (noncondensing) | 10% to 80%                    | 20% to 80%                       | 20% to 50%                    | 5% to 80%                      |
| Wet bulb temperature              | 26°C<br>(79°F)                | 26°C<br>(79°F)                   | 26°C<br>(79°F)                | 26°C<br>(79°F)                 |

**Notes:**

- 1. Operational storage equals less than 1 year.

2. Archival storage equals 1 to 10 years.

---

### Perform a Thorough Inspection

- 1 Inspect the cartridge's packaging to determine potential rough handling.
- 1 When inspecting a cartridge, open only the cartridge door. Do not open any other part of the cartridge case. The upper and lower parts of the case are held together with screws; separating them destroys the usefulness of the cartridge.
- 1 Inspect the cartridge for damage before using or storing it.
- 1 Inspect the rear of the cartridge (the part that you load first into the tape load compartment) and ensure that there are no gaps in the seam of the cartridge case. If there are gaps in the seam, the leader pin may be dislodged.
- 1 Check that the leader pin is properly seated.
- 1 If you suspect that the cartridge has been mishandled but it appears useable, copy any data onto a good cartridge immediately for possible data recovery. Discard the mishandled cartridge.
- 1 Review handling and shipping procedures.

### Handle the Cartridge Carefully

- 1 Do not drop the cartridge. If the cartridge drops, slide the cartridge door back and ensure that the leader pin is properly seated in the pin-retaining spring clips.
- 1 Do not handle tape that is outside the cartridge. Handling the tape can damage the tape's surface or edges, which may interfere with read or write reliability. Pulling on tape that is outside the cartridge can damage the tape and the brake mechanism in the cartridge.
- 1 Do not stack more than six cartridges.
- 1 Do not degauss a cartridge that you intend to reuse. Degaussing makes the tape unusable.

---

### Cleaning the Tape Mechanism

Dell PowerVault LTO3-060 drives have been developed to have a minimal cleaning requirement. The clean LED will be lit solid when the drive needs cleaning. Only insert a cleaning cartridge into the tape drive when the clean LED is lit.

- ➔ **NOTICE:** Only use LTO cleaning cartridges that are labeled "universal." Some Generation 1 cleaning cartridges may not be the universal type. The Generation 3 tape drive is only compatible with the LTO Ultrium universal cleaning cartridges. Use of any other type of cleaning cartridge or method can damage the read/write head in your drive. If you load any other type of cleaning cartridge, the tape drive ejects it immediately.

An LTO Ultrium universal cleaning cartridge is supplied with each tape drive. Do *not* use swabs or other means of cleaning the heads. The cleaning cartridge uses a special tape to clean the tape heads.

Though the number may vary according to the manufacturer, the universal cleaning cartridge is generally valid for 50 cleanings. If the cleaning cartridge is ejected immediately and the Clean and Fault LEDs start to flash slowly, then it has expired or it is not a supported cleaning cartridge. Discard it and use a new one. If the cartridge is expired or not supported, the cleaning light will remain on.

To use the LTO Ultrium universal cleaning cartridge:

1. Insert a cleaning cartridge into the tape drive. The tape drive performs the cleaning automatically. When the cleaning is finished, the drive ejects the cartridge.
2. Remove the cleaning cartridge from the drive.

---

Please read all [restrictions and disclaimers](#).

---

[Back to Contents Page](#)