

# PS SERIES STORAGE ARRAYS QUICKSTART

MODEL 3000 SERIES  
PS Series Firmware Version 3.0



Copyright © 2006 EqualLogic, Inc.

September 2006

EqualLogic is a registered trademark of EqualLogic, Inc.

All trademarks and registered trademarks mentioned herein are the property of their respective owners.

Possession, use, or copying of the documentation or the software described in this publication is authorized only under the license agreement.

EqualLogic, Inc. will not be held liable for technical or editorial errors or omissions contained herein. Information in this document is subject to change.

PS Series Firmware Version 3.0

Part Number: 110-0040-R2

# Table of Contents

---

Preface .....	v
Introduction to PS Series Storage Arrays .....	1
Steps for Setting Up and Using an Array .....	2
Step 1. Set Up the Array Hardware .....	3
A. Unpack Shipping Box and Gather Hardware .....	3
B. Mount Array in a Stable Rack .....	6
C. Connect Power Cables for Grounding .....	8
D. Connect Array to a Network Switch .....	9
E. Turn on Power to Array and Check LEDs for Errors .....	12
F. Connect Array to a Console Terminal .....	15
Step 2. Configure the Array and Create a Group .....	16
Step 3. Set the RAID Policy .....	19
Using the GUI to Set the RAID Policy .....	19
Using the CLI to Set the RAID Policy .....	23
Step 4. Create a Volume .....	25
Using the GUI to Create a Volume .....	26
Using the CLI to Create a Volume .....	29
Step 5. Connect to the Volume from a Host System .....	30
Advanced Operations and More Information .....	31
Index .....	35



# Preface

---

This *QuickStart* describes how to set up EqualLogic PS Series 3000 storage array hardware and create a PS Series group—a self-managing, iSCSI storage area network (SAN) that is affordable and easy to use, regardless of scale.

After setting up the group, see the PS Series *Group Administration* manual for information about managing the group.

## Audience

This *QuickStart* is designed for administrators responsible for setting up array hardware and creating a group. Although administrators do not need extensive network or storage system experience, it may be useful to understand:

- Basic networking concepts
- Current network environment
- User disk storage requirements
- RAID configurations
- Disk storage management

**Note:** This *QuickStart* describes using PS Series arrays in some common network configurations. However, detailed information about setting up a network is beyond its scope.

## Organization

This *QuickStart* is organized as follows:

- *Introduction to PS Series Storage Arrays*
- *Steps for Setting Up and Using an Array*
  - Step 1. Set Up the Array Hardware*
  - Step 2. Configure the Array and Create a Group*
  - Step 3. Set the RAID Policy*
  - Step 4. Create a Volume*
  - Step 5. Connect to the Volume from a Host System*
- *Advanced Operations and More Information*

## EqualLogic Website

The EqualLogic website, [www.equallogic.com](http://www.equallogic.com), has the latest product firmware and documentation, in addition to warranty information.

## Product Documentation and Technical Support

For detailed information about PS Series arrays, groups, and volumes, see the following documentation:

- *Release Notes*. Provides the latest information about PS Series arrays.
- *QuickStart*. Describes how to set up the PS Series Model 3000 array hardware and create a PS Series group.
- *Group Administration*. Describes how to use the Group Manager graphical user interface (GUI) to manage a PS Series group. This manual provides comprehensive information about product concepts and procedures.
- *CLI Reference*. Describes how to use the Group Manager command line interface (CLI) to manage a PS Series group and individual arrays.
- *Hardware Maintenance*. Provides information about maintaining the PS Series Model 3000 array hardware.

The *QuickStart* and the *Hardware Maintenance* manual are printed and shipped with the product. They are also located on the documentation CD-ROM that is shipped with the product, along with the *Group Administration* and *CLI Reference* manuals and the Group Manager online help.

In addition, the Host Integration Tools for Windows® systems are available on the EqualLogic website and on a CD-ROM that is shipped with the product.

Technical support on EqualLogic products is available for customers with arrays under warranty and customers with a valid support contract. You can obtain technical support in the following ways:

- Visit the EqualLogic Customer Support website to download the latest documentation and firmware. Go to [www.equallogic.com](http://www.equallogic.com) and log in to your support account. If you do not have an account, register for an account.
- From the EqualLogic Customer Support website, you can submit a service request.

- In the United States, call 877-887-7337. International customers should call +00 1 919-767-5729. If the issue is urgent, ask to speak with a member of the EqualLogic Customer Support team.
- Send e-mail to [support@equallogic.com](mailto:support@equallogic.com) and clearly describe the issue or problem.

## Online Help

For help on the Group Manager graphical user interface (GUI) and command line interface (CLI), click `Tools` in the bottom left corner of the GUI window to expand the menu. Then, click `Online Help`.

The Group Manager CLI also provides help at the command line. In addition, the `setup` utility provides help for each prompt.

## Warranty Information

The license agreement and warranty information are included in the PS Series array shipping box. To register your array, go to [www.equallogic.com](http://www.equallogic.com), click `Support`, and then click `warranty registration`.

## Restricted Access Requirement

PS Series arrays must be installed in a restricted access location. A restricted access location is an area that is intended only for qualified or trained personnel.





# Introduction to PS Series Storage Arrays

---

EqualLogic PS Series storage arrays deliver the benefits of consolidated storage in a storage area network (SAN) that is affordable and easy to use—regardless of its size. With intelligent, automated management and fast, flexible scalability, PS Series arrays greatly reduce storage acquisition and management costs. This *QuickStart* describes how to start using your PS Series array.

By grouping together one or more PS Series arrays connected to an IP network, you can create a **PS Series group**—a highly-scalable iSCSI SAN with a shared pool of storage space. Integrated virtualization software makes a group easy to manage and provides automatic RAID configuration, data provisioning, and load balancing. To increase SAN capacity and performance, connect another array to the network and add it to the group—data remains online at all times.

To ensure high reliability, PS Series storage arrays include RAID-protected disks, automatic disk sparing, redundant fans and power supplies, and dual high-performance control modules, each with three Gigabit Ethernet interfaces and a battery-backed cache.

A simple setup utility lets you quickly configure an array as a **member** of a new or existing group. RAID configuration and load balancing (network and data) occur automatically. Both graphical and command line user interfaces are available for group management.

In a multi-member group, you can separate space into **storage pools**, which allow you to organize storage according to usage, providing more control over resource allocation, while maintaining a single system management view.

Using the Group Manager graphical or command line user interface, you create **volumes**, assigning to each volume a pool, size, access controls, and other attributes. A volume can be spread across multiple disks and group members and is seen on the network as an **iSCSI target**. Members and volumes can move between pools to meet business objectives.

To connect to a volume, a host needs only a standards-compliant **iSCSI initiator**. Volume access can be restricted through IP address, initiator name, or CHAP (Challenge Handshake Authentication Protocol) credentials. Once connected, the volume is seen by the host as a regular disk that can be formatted as usual.

At a minimum, a group consists of one array with one network connection, but you can configure three network interfaces for maximum array bandwidth. Data and network I/O are automatically load balanced across disks and interfaces—with no impact on data availability.

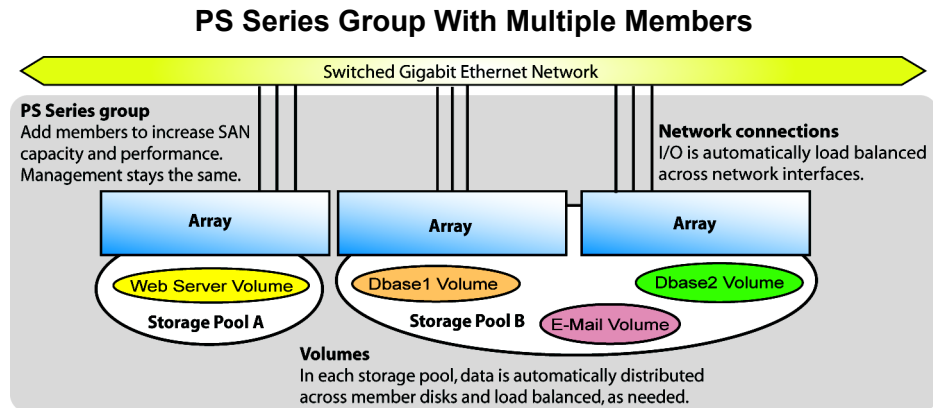

You can easily increase group capacity and bandwidth by adding arrays. When an array is added to a group, it obtains the group configuration from the existing members. Once you choose a RAID policy for the member, the pool is automatically expanded, and volume data and network I/O are load balanced across the pool members' disks and network connections. Volumes continue to be accessible through the same iSCSI targets, and no host modifications are necessary. Management overhead remains the same, regardless of the group size.

## Steps for Setting Up and Using an Array

To start using your PS Series array:

- Step 1.** Set up the array hardware configuration.
- Step 2.** Configure the array on the network and create a group.
- Step 3.** Log in to the group and specify the RAID policy for the array.
- Step 4.** Create a volume.
- Step 5.** Connect to the volume from a host system.

## Step 1. Set Up the Array Hardware

### A. Unpack Shipping Box and Gather Hardware

The order in which you unpack the shipping box is important for safety:

1. Open the outer shipping box and remove the accessory box.
2. Remove the accessories and ensure that you have the contents shown in the figure *Shipping Box Contents*.
3. Following the unpacking instructions in the shipping box, lift the array and place it on a flat surface that is protected from electrostatic discharge. Do not remove the plastic bag from the array until you are ready to install it in a rack.
4. Gather the hardware that is not included in the box, as described in the table *Required Hardware – Not Supplied*.



The array is *heavy*. Do not attempt to lift or install the array without assistance.

### Shipping Box Contents

#### PS Series 3000 Storage Array Chassis

Rear of chassis (control modules, operations panel, and power supply/cooling modules)

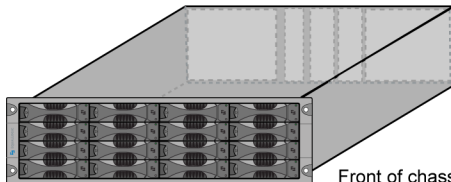

Front of chassis  
(16 disks or blanks)

#### Power Cables

Power cables for various electrical configurations will be provided.

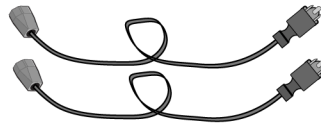

#### Documentation

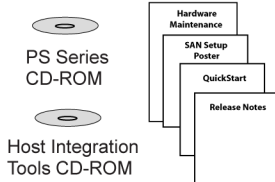

#### Serial Null Modem Cable

Used for initial array setup or when there is no network access to array.



#### Electrostatic Wrist Strap



#### Assembly Kit for Four-Pole Rack

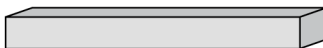

Instructions for assembly installation are included in each kit.

#### Assembly Kit for Two-Pole Rack



### Description of Shipping Box Contents

Component	Description
3U storage array chassis	Contains one or two control modules, two power supply/cooling modules, and eight or 16 disks.
Power cables	Connects an array to one or more power sources. The shipping box may contain multiple power cables to meet the electrical requirements of the country in which the array will reside. <b>Caution:</b> Be sure to use only these enclosed power cables with this product.
Serial null modem cable	Creates a serial connection between an array and a console or terminal emulator. The cable has two DB9, 9-pin, female connectors and is used only for the initial member and group configuration or if there is no network access to the array.
Four-pole rack assembly kit	Enables you to install an array in a four-pole rack. Instructions for assembly are included in the kit.
Two-pole rack assembly kit	Enables you to install an array in a two-pole rack. Instructions for assembly are included in the kit.
Electrostatic wrist strap	Protects sensitive hardware from electrical discharge.
Documentation and CD-ROMs	Printed documentation includes the PS Series <i>QuickStart</i> , <i>Hardware Maintenance</i> , <i>Release Notes</i> , and SAN setup poster.  The <i>Group Administration</i> and <i>CLI Reference</i> manuals and the Group Manager online help are on the documentation CD-ROM, along with the <i>QuickStart</i> and <i>Hardware Maintenance</i> manuals.  Host Integration Tools for Windows® systems and related documentation are on the HIT CD-ROM.  License and warranty information is also included in the shipping box.

**Note:** Product returns will be accepted only in the original packaging or in authorized packaging obtained from your PS Series support provider.

Array installation also requires the hardware described in *Required Hardware – Not Supplied*. This hardware is not provided with your array.

### Required Hardware – Not Supplied

Component	Description
Standard 19" two- or four-pole rack	Provides easy access to storage arrays and other hardware in your computing environment.
One or more network cables	Connects an array to a network switch. Use Category 5E or Category 6 cables with RJ45 connectors. You can also use Category 5 cables if they adhere to the TIA/EIA TSB95 standard.  Only one network connection is required for operation, but as many as six connections (maximum of three active) are possible.
Network switch	Connects devices to a network. If possible, connect the array to different switches for high availability.
Computer or a console terminal	Enables you to perform the initial array and group configuration or manage the group when there is no active network connection. A computer must be running a terminal emulator.

The following table describes the optional hardware that you can use in a storage array installation. This hardware is not provided with your array.

### Optional Hardware – Not Supplied

Component	Description
One or two UPS systems	Provide a highly available source of power to an array. Each UPS system should be on a different circuit and must provide the correct type of voltage for an adequate amount of time.

## B. Mount Array in a Stable Rack

A PS Series array must be mounted in a two-pole or four-pole 19" rack. Instructions for rack assembly and mounting an array are included with the two-pole assembly kit and the four-pole assembly kit in the array shipping box.

When mounting an array in a rack, you must meet the following recommendations and requirements:

- Be sure there is sufficient space for air flow in front of and behind the array.
- It is recommended that you attach the rack to the floor for added stability.
- Be sure to support the array until it is completely mounted in the rack.
- The location of the array must be properly vented and must meet the environmental, power, and physical requirements described in the following table.

**PS Series Storage Array Requirements**

Component	Requirement
Weight of fully-loaded array	80 pounds or 36.36 kilograms
Operating temperature	41 to 104 degrees F / 5 to 40 degrees C
Storage temperature	-22 to 140 degrees F / -30 to 60 degrees C
Maximum altitude	10,000 feet
Operational relative humidity	8 to 90% non-condensing
Thermal output of fully-loaded array	2200 BTU/hour, 660 watts
Shock	30 G for 2 ms
Vibration	.1 G @ 10 to 100 hertz
Input voltage	90 to 264 VAC (auto-sensing)
Input current	5.5 amperes (maximum, single power supply) @ 120 volts
Input frequency	50 to 60 hertz
Input power	660 VA
Power supplies	Dual, 450 watts DC output
Height/Width/Depth	5.25" x 17 5/8" x 22.5" 13.33 cm x 44.77 cm x 56.25 cm

---

### Four-Pole Rack Example

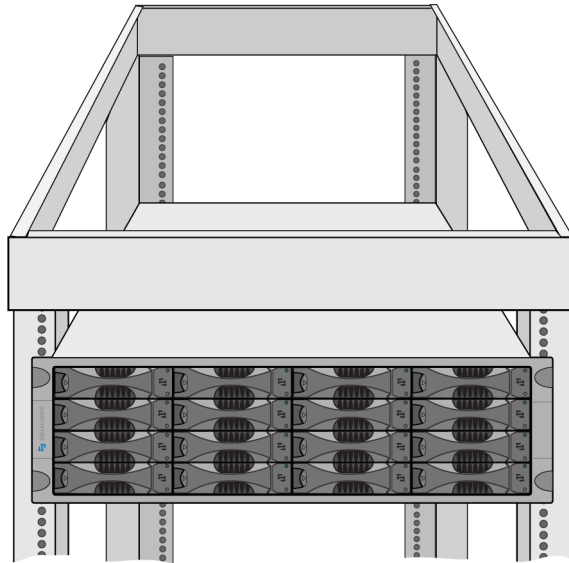

Be sure to support the array until it is completely mounted in the rack.

---

### Two-Pole, Mid-Mount Rack Example

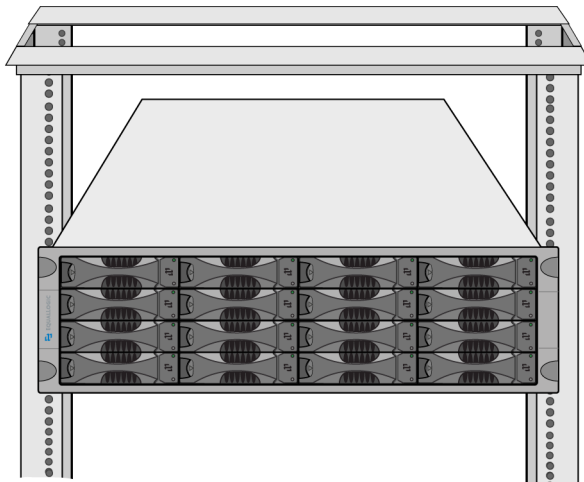

### C. Connect Power Cables for Grounding

A PS Series array includes two power supply/cooling modules. It is recommended that you connect both power supplies to different sources of power, preferably on separate circuits for increased availability.

For a highly-available power configuration, connect one power supply to an uninterruptible power supply (UPS) system, and connect the other power supply to a different source of power. See the table *PS Series Storage Array Requirements* on page 6 for information about voltage requirements.

**Notes:** *Do not* turn on power to the array. At this time, the power cables are only for grounding purposes.

If your PS Series array was shipped with power cables, use these cables to meet safety requirements.

To connect power cables to an array, refer to the figure shown next. Be sure to use the cable strain relief when securing the power cable in the array.

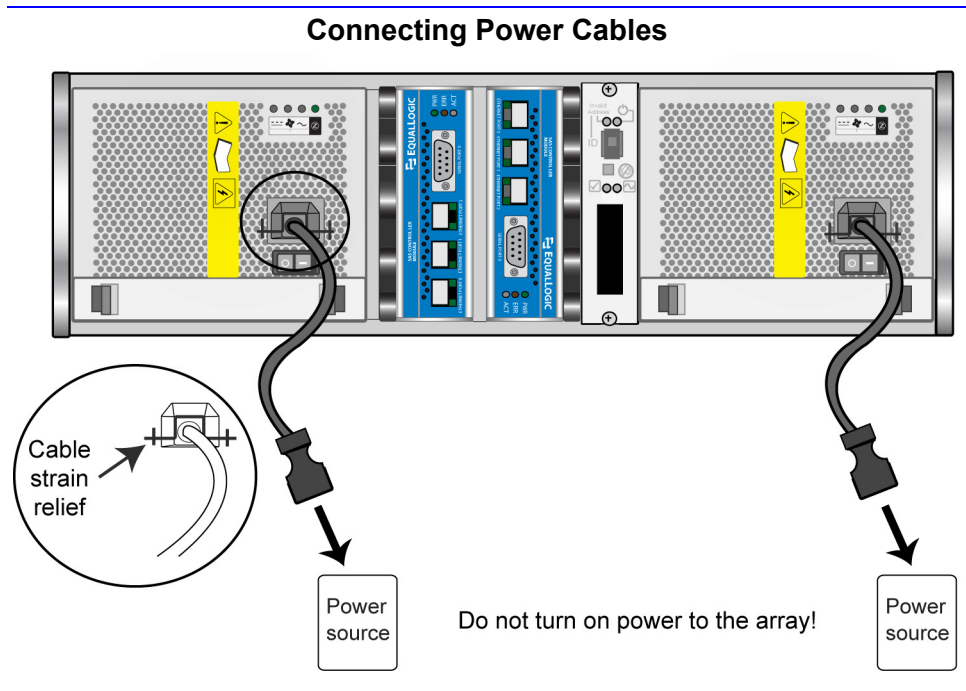



## D. Connect Array to a Network Switch

A PS Series array includes one or two control modules. Only one control module is active (serving network traffic) at one time. The secondary (redundant) control module mirrors cache data from the active control module. If the active control module fails, the secondary will take over network operations.

Each control module has three Ethernet network interface ports, labeled PORT 0, PORT 1, and PORT 2, for up to three active connections to the network.

In addition to the requirements and recommendations described in the following tables, all the usual rules for proper network configuration apply to the group members. General network configuration is beyond the scope of this document.

### Network Requirements

Requirement	Description
One or more network connections	An array must have at least one functioning network interface connected to a network (through a network switch, if possible). When you configure the array, as described later in this <i>QuickStart</i> , you assign an IP address and netmask to this interface.  In a dual control module array, to ensure network availability regardless of which control module is active, connect a cable to the network interface port on each control module.
Correct network cables	Use Category 5E or Category 6 cables with RJ45 connectors. You can also use Category 5 cables if they adhere to the TIA/EIA TSB95 standard.

### Network Recommendations

Recommendation	Description
Switched Gigabit Ethernet network	Connect arrays and hosts to a switched network and ensure that all network connections between hosts and arrays are Gigabit Ethernet. An array can operate at 10 and 100 Mbits, but performance will be significantly degraded.
Multiple network connections	For increased bandwidth and availability, connect multiple network interfaces to the network (and different switches, if possible). Connect interfaces in the following order: PORT 0, PORT 1, and PORT 2.  After the initial setup, use the Group Manager GUI or CLI to assign an IP address and netmask to each additional interface.

### Network Recommendations (Continued)

Recommendation	Description
Access to the group IP address	In a multi-subnet group, each configured network interface should have access to the subnet on which the group IP address resides.
Redundant network paths	Using a multipathing solution helps to ensure that no single point of failure exists between hosts and arrays.
For replication, a reliable, adequately sized network link	For effective and predictable replication, be sure that the network link between the primary and secondary groups is reliable and provides sufficient bandwidth for copying data.
No STP functionality on switch ports that connect end nodes	<p>Do not use Spanning-Tree (STP) on switch ports that connect end nodes (iSCSI initiators or storage array network interfaces).</p> <p>However, if you want to use STP or RSTP (preferable to STP), you should enable the port settings available on some switches that let the port immediately transition into STP forwarding state upon link up. This functionality can reduce network interruptions that occur when devices restart, and should only be enabled on switch ports that connect end nodes.</p> <p><b>Note:</b> The use of Spanning-Tree for a single-cable connection between switches is encouraged, as is the use of trunking for multi-cable connections between switches.</p>
Flow Control enabled on switches and NICs	Enable Flow Control on each switch port and NIC that handles iSCSI traffic. PS Series arrays will correctly respond to Flow Control.
Unicast storm control disabled on switches	Disable unicast storm control on each switch that handles iSCSI traffic, if the switch provides this feature. However, the use of broadcast and multicast storm control is encouraged on switches.
Jumbo Frames enabled on switches and NICs	Enable Jumbo Frames on each switch and NIC that handles iSCSI traffic to obtain any performance benefit and ensure consistent behavior.
VLANs	Configure switches to use VLANs in order to separate iSCSI SAN traffic from other network traffic.

The minimum network configuration for a single control module array is one network connection to PORT 0. The minimum network configuration for a dual control module array is one network connection to PORT 0 on each control module, as shown in the figure *Minimum Dual Control Module Network Configuration*. This configuration protects against control module failure.

---

### Minimum Dual Control Module Network Configuration

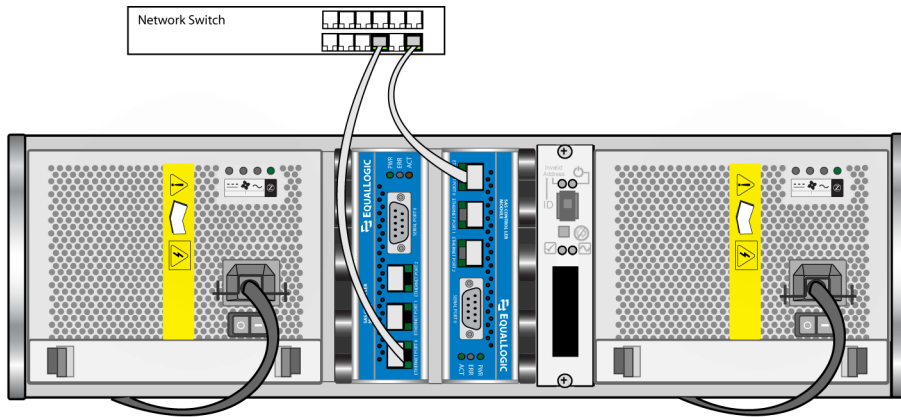

For maximum network bandwidth and availability, connect cables to all network ports and distribute the connections across multiple network switches, as shown in the figure *High Performance, High-Availability Network Configuration*.

---

### High Performance, High-Availability Network Configuration

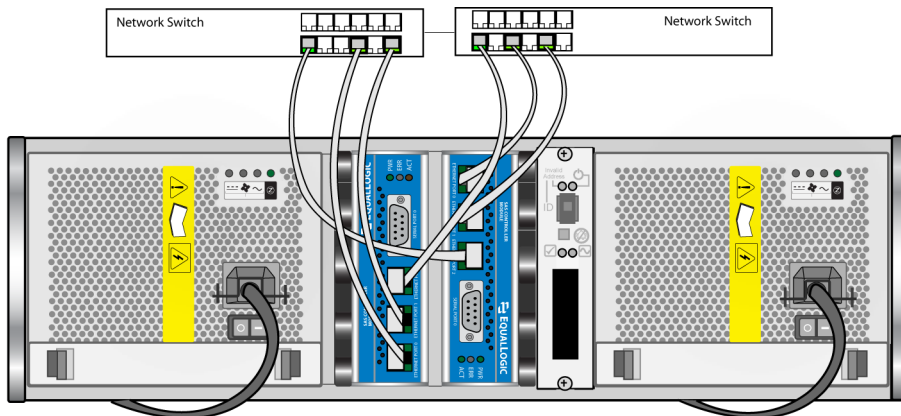

### E. Turn on Power to Array and Check LEDs for Errors

Before turning on power, *be sure* the array is at room temperature. If an LED indicates a problem, contact the support provider for your PS Series array.

#### Disk LEDs

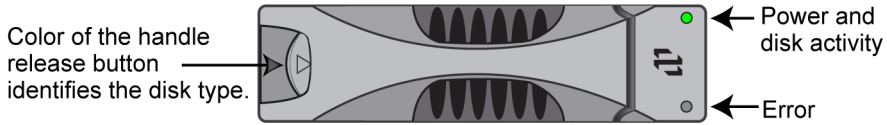

#### Backpanel LEDs

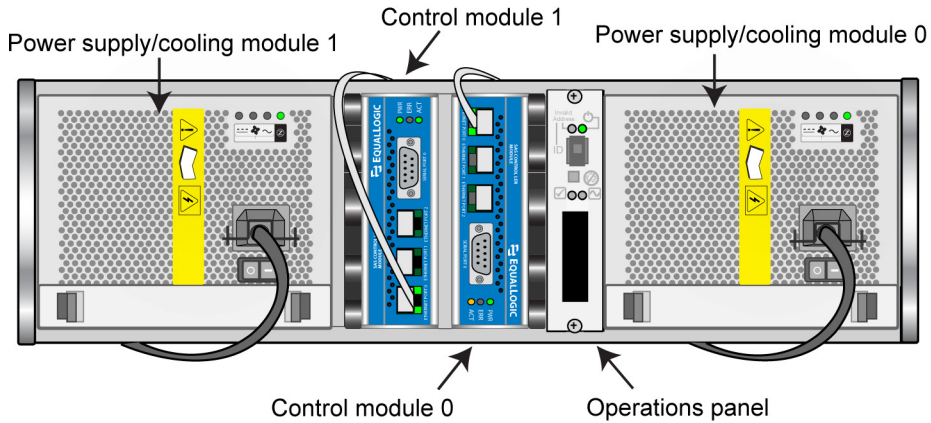

#### Disk LED Descriptions

Disk LEDs	Color	Description
Top	Off	No power or error condition.
	Green	Power.
	Flashing green	Disk activity.
Bottom	Off	No power or normal condition.
	Red	Error condition.

#### Operations Panel LED Descriptions

Operations LEDs	Color	Description
Power (upper right)	Off	No power.
	Green	Power.

**Operations Panel LED Descriptions (Continued)**

Operations LEDs	Color	Description
Array locator (upper left)	Off	No power or normal condition.
	Flashing orange	Administrator enabled the array locator function.
Warning condition (lower left)	Off	No power or normal condition.
	Flashing orange	One or more of the following has occurred: <ul style="list-style-type: none"> <li>RAID set is degraded but still functioning.</li> <li>RAID set (volume level) has lost blocks.</li> <li>Component temperature is near a limit.</li> <li>Fan has failed or RPMs exceed upper or lower limit.</li> <li>Power supply is not installed or has no power.</li> <li>Only one control module installed or control module has failed over.</li> <li>Active control module syncing with secondary.</li> <li>No communication between control modules.</li> <li>No replication progress for more than 1 hour.</li> <li>Installed spare disk does not have enough capacity to replace a disk in a RAID set.</li> <li>A non-critical hardware component failed.</li> </ul>
Error condition (lower right)	Off	No power or normal condition.
	Flashing orange	One or more of the following has occurred: <ul style="list-style-type: none"> <li>RAID is not functioning.</li> <li>Lost block table is full.</li> <li>Temperature exceeds upper or lower limit.</li> <li>Control module cache has lost data.</li> <li>One or both fan trays are not installed.</li> <li>Both fans on a fan tray have failed.</li> <li>Cache battery has less than 72 hours of charge or temperature is too high to charge battery.</li> <li>NVRAM coin cell battery has failed.</li> <li>Cache contains data that does not belong to any of the installed disks.</li> <li>More than one valid RAID set exists in array.</li> <li>Control modules are different models.</li> <li>A critical hardware component has failed.</li> <li>Operations panel failed or not installed.</li> <li>Storage enclosure processor that monitors array components has experienced a failure.</li> </ul>





### Control Module LED Descriptions

Control Module LEDs	Color	Description
ACT	Off	No power, secondary control module is not synchronized with active control module, or error condition.
	Green	Active control module (serving network I/O).
	Orange	Secondary control module; cache is synchronized with active control module.
ERR	Off	No power or no error condition.
	Red	Array is starting up or error condition.
PWR	Off	No power.
	Green	Power.

### Network Interface LED Descriptions

Network Interface LEDs	Color	Description
Left	Off	No power or not connected to network.
	Green	Connected to network.
Right	Off	No power or not transmitting.
	Green	Transmitting.

### Power Supply/Cooling Module LED Descriptions

Power Supply/Cooling Module LED	Color	Description
	Off	No power or normal condition
	Orange	DC power failure
	Off	No power or normal condition
	Orange	Fan failure
	Off	No power or normal condition
	Orange	AC power failure
	Off	No power
	Green	Normal array operation

## F. Connect Array to a Console Terminal

Establish a serial connection between the array and a console terminal (or a computer running a terminal emulator) to run the `setup` utility, which enables you to configure the array and add it to a group. After setting up the array, the serial connection is not needed, but you should keep the serial cable. You can use a serial connection if there is no network access to the group or array.

**Note:** If you have a Microsoft® Windows® system, you can use the EqualLogic® Remote Setup Wizard to configure an array and create a group instead of using the `setup` utility. The wizard does not require the serial cable.

The serial connection must have the following characteristics:

- 9600 baud
- One STOP bit
- No parity
- 8 data bits
- No hardware flow control

To create a serial connection, obtain the null modem cable that shipped with the array and refer to the next figure. The serial cable must always be connected to Serial Port 0 on the active control module (ACT LED will be green).

---

### Connecting the Serial Cable

- ① Attach one DB9, 9-pin female connector to Serial Port 0 on the active control module (ACT LED is green).
- ② Attach the other DB9, 9-pin female connector to a console or computer running a terminal emulator.

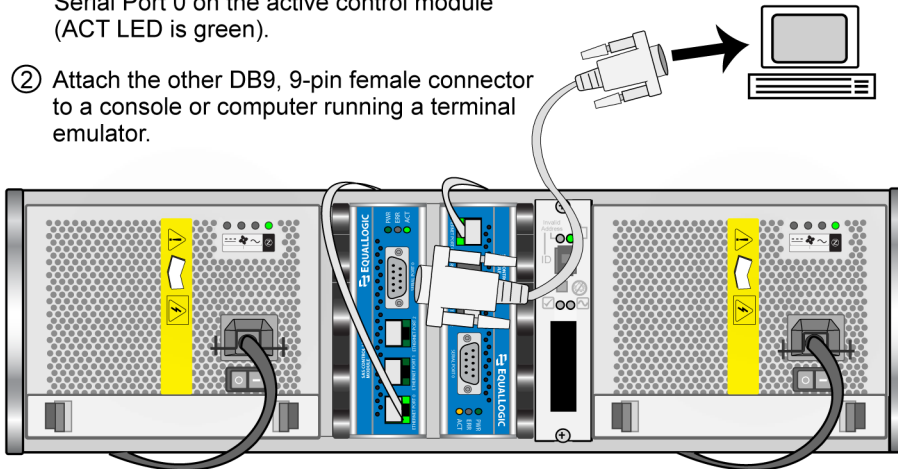

## Step 2. Configure the Array and Create a Group

The `setup` utility enables you to configure a storage array on the network and create a PS Series group with the array as the first member. The utility prompts for the array's network configuration and the group configuration, including the group IP address.

**Note:** See the tables *Network Requirements* and *Network Recommendations* on page 9 for additional network information.

After the `setup` utility completes, the group is available on the network. Next, log in to the group using the Group Manager GUI or CLI and set the RAID policy for the first member.

- A. Before running the `setup` utility, gather the information described in the *Member Configuration* and *Group Configuration* tables shown below. Obtain IP addresses from your network administrator, as needed.

### Member Configuration

Prompt	Description
Member name	Unique, descriptive name (up to 64 alphanumeric characters; no spaces). First character must be a letter or number. Used to identify and administer the array.
Network interface	Name of a network interface (either <code>eth0</code> , <code>eth1</code> , or <code>eth2</code> ) that is connected to a functioning port on a network switch.
IP address	Network address for the named network interface. <b>Note:</b> Each member must have at least one network interface on the same subnet as the group IP address.
Netmask	Combines with the IP address to identify the subnet on which the named network interface resides (default is 255.255.255.0).
Default gateway (optional)	Network address for the device used to connect subnets and forward network traffic beyond the local network. A default gateway is needed only if you want the named network interface to communicate outside the local network (for example, to allow access to volumes from hosts outside the local network). <b>Note:</b> The default gateway must be on the same subnet as the named network interface.



## Group Configuration

Prompt	Description
Group name	Name of the group (up to 54 characters). Valid characters include letters, number, and dashes. The first character must be a letter or number. Identifies the group for the purposes of adding new members or setting up replication.
Group IP address	Network address for the group. The group IP address is used for group administration and host access to data stored in the group.
Password for managing group membership	Password required when adding members to the group. The password must have 3 to 16 alphanumeric characters and is case-sensitive.
Password for the default group administration account	Password that will override the factory-set password ( <code>grpadmin</code> ) for the default <code>grpadmin</code> account. The password must have 3 to 16 alphanumeric characters and is case-sensitive.

- B. Using the serial connection you established in *Step 1-F* on page 15, press the **Enter** key. At the login prompt, enter the `grpadmin` account name and the factory-set password, which is also `grpadmin`. Note that passwords are not echoed on the screen.

```
Login: grpadmin
Password: grpadmin
```

```
Welcome to Group Manager
Copyright 2001-2006 EqualLogic, Inc.
```

```
It appears that the storage array has not been configured.
Would you like to configure the array now? (y/n) [n] y
```

- C. If you respond by typing `y` and pressing the **Enter** key, the following dialog appears. You can also enter `n` and, at a later time, type `setup` at the console prompt (`>`). The utility prompts for the member and group configuration. Press the **Enter** key to accept a default value. Enter `?` to obtain help.

An example of running the `setup` utility is shown next. There may be a short delay after entering the group IP address as the array searches the network.

### Example of Configuring an Array and Creating a Group

```

Group Manager Setup Utility

The setup utility establishes the initial network and storage
configuration for a storage array and then configures the array
as a member or a new or existing group of arrays.

For help, enter a question mark (?) at a prompt.

Do you want to proceed (yes | no) [no]? yes

Initializing. This may take several minutes to complete.

Enter the network configuration for the array:

Member name []: member01
Network interface [eth0]: eth0
IP address for network interface []: 192.17.2.41
Netmask [255.255.255.0]: Enter
Default gateway [192.17.2.1]: Enter

Enter the name and IP address of the group that the array will join.

Group name []: group01
Group IP address []: 192.17.2.40

Searching to see if the group exists. This may take a few minutes.

The group does not exist or currently cannot be reached. Make sure
you have entered the correct group IP address and group name.

Do you want to create a new group (yes | no) [yes]? yes

Group Configuration

Group Name:                group01
Group IP address:          192.17.2.40

Do you want to use the group settings shown above (yes | no) [yes]: yes

Password for managing group membership:
Retype password for verification:

Password for the default group administration account:
Retype password for verification:

Saving the configuration ...

Waiting for configuration to become active.....Done

Group member member01 now active in the group.

Group group01 has been created with one member.

Use the Group manager GUI or CLI to set the RAID policy for the member.
You can then create a volume which a host can connect to using an iSCSI
initiator.

```

## Step 3. Set the RAID Policy

After you create the group, use the Group Manager GUI or CLI to set the RAID policy for the member. This will configure the disks automatically according to the selected RAID policy, with the appropriate number of spare disks.

Once you set the RAID policy, volume data can be stored on the member. Until the RAID configuration completes, performance will not be optimal, but the group is fully operational.

You can convert a member to a different RAID policy only if the new policy requires *less* disk space than the current policy.

### Using the GUI to Set the RAID Policy

To start the GUI, specify the group IP address in a Web browser. When prompted, log in to the group by entering the `grpadmin` account name and the password that you specified when creating the group. The Group Summary window appears, displaying the current group configuration and storage pool capacity.

Initially, the Group Summary window will display a message that a member exists with an unconfigured RAID policy. This is normal.

### Group Summary – RAID Policy Not Set

The screenshot displays the EqualLogic Group Summary GUI for a group named 'group01'. The interface includes a navigation tree on the left, a main content area with several sections, and a status bar at the bottom.

**Account:** grpadmin **Logged in:** 5/22/06 3:11:06 PM **Logout**

**Group group01**

**Activities**

- Group group01
  - Getting Started
    - Create volume
    - Create account
    - Create storage pool
  - Administration
    - Group configuration
    - Group monitoring
    - Storage pools
    - Members
    - Volumes
    - Replication
    - Collections
  - Replication
    - Configure partner

**Group Information**

General Settings	Volumes	Snapshots	Collections
Group name: group01	Volumes: 0	Snapshots: 0	Volume collections: 0
IP address: 172.19.101.130	Online: 0	Online: 0	Snapshot collections: 0
Location: default	In use: 0	In use: 0	Custom snapshot collections: 0

**Group Disk Space**

**Total group capacity 0 MB**

- Used by volumes 0 MB
- Reserved for snapshots 0 MB
- Reserved for replication 0 MB
- Delegated space 0 MB
- Free space 0 MB

Group space utilization  
 RAID level space distribution  
 Storage pool capacity  
 Delegated space utilization

**Storage Pools and Group Members**

**Member exists with unconfigured RAID policy. Select member to configure its RAID policy.** [View legend](#)

Storage pool default Capacity 0 MB

member01

**Tools** **No outstanding alarms**

If you place the mouse over the unconfigured member, the following pop-up is displayed, indicating a normal health status.

### Not Configured Pop-Up

**Member member01**  
 Storage pool: default  
 RAID policy: not configured  
 Disks: 16 (SAS)  
 Status:  not configured  
 Health status: normal  
 LEDs not flashing  
 Description:

To set the RAID policy for the member, expand `Members` in the far left panel and select the member name. The following warning appears.

### Warning RAID Not Configured

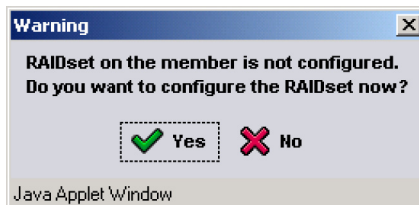

Click `Yes` and the `Configure Member – General Settings` dialog box appears.

### Configure Member – General Settings

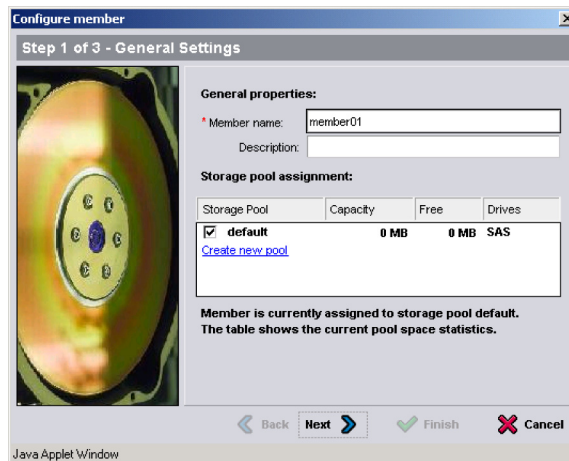

Click **Next** to continue. The Configure Member – RAID Set Configuration dialog box appears.

### Configure Member – RAID Set Configuration (RAID-50)

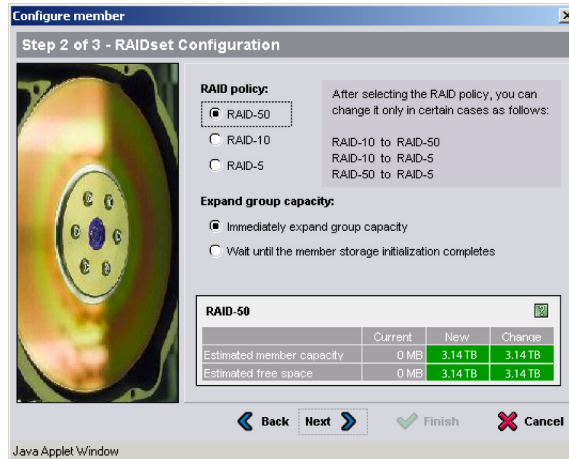

Specify the RAID policy by selecting one of the buttons under RAID policy:

- **RAID-10** – Striping on top of multiple RAID 1 (mirrored) sets, with two spare disks. RAID-10 provides good performance for random writes, in addition to the highest availability. However, since the disks are mirrored, RAID-10 provides the least capacity.
- **RAID-50** – Striping on top of two RAID 5 (distributed-parity) sets, with two spare disks. RAID-50 provides a good balance of performance (especially for sequential writes), availability, and capacity.
- **RAID-5** – One RAID 5 set, with one spare disk. RAID-5 is similar to RAID-50, with more capacity (two additional disks) but lower availability and performance.

The values in the dialog box table reflect the pool capacity, based on the selected RAID policy. In the preceding dialog box, selecting RAID-50 yields an estimated member capacity of 3.14 TB. Selecting RAID-10 yields an estimated member capacity of 1.83 TB, as shown in the following dialog box.

### Configure Member – RAID Set Configuration (RAID-10)

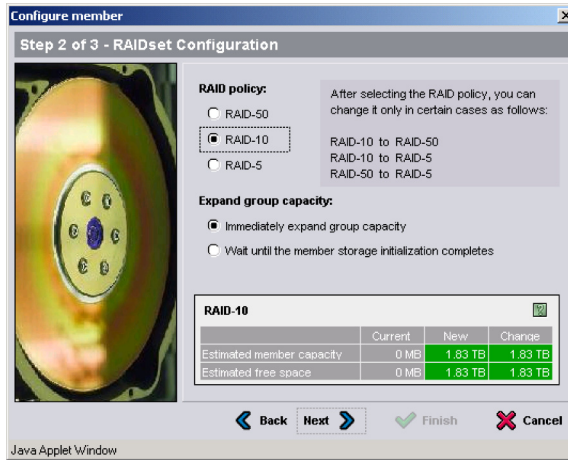

Select the desired RAID policy and click **Next** to continue. The **Configure Member – Summary** dialog box appears.

### Configure Member – Summary

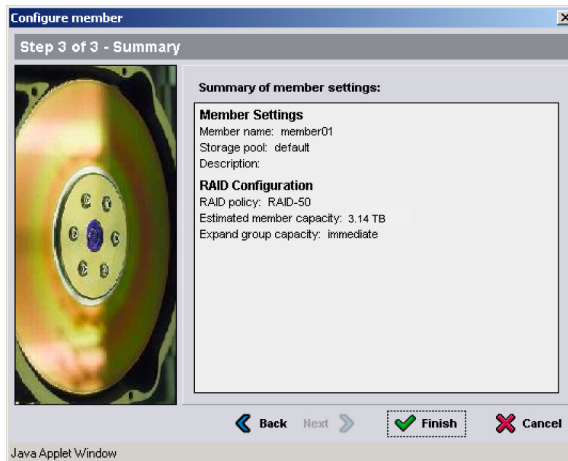

If the member configuration is satisfactory, click **Finish**. The following window shows a completed configuration for a one-member group.

## Group Summary – Completed Member Configuration

The screenshot displays the 'Group Summary' page for 'Group group01' in the EqualLogic management console. The page is organized into several sections:

- Group Information:**
  - General Settings:** Group name: group01, IP address: 172.17.128.175, Location: default.
  - Volumes:** Volumes: 0, Online: 0, In use: 0.
  - Snapshots:** Snapshots: 0, Online: 0, In use: 0.
  - Collections:** Volume collections: 0, Snapshot collections: 0, Custom snapshot collections: 0.
- Group Disk Space:**
  - Total group capacity:** 3.13 TB.
  - Usage breakdown:**
    - Used by volumes: 0 MB (0.0%)
    - Reserved for snapshots: 0 MB (0.0%)
    - Reserved for replication: 0 MB (0.0%)
    - Delegated space: 0 MB (0.0%)
    - Free space: 3.13 TB (100.0%)
  - Options:**
    - Group space utilization
    - RAID level space distribution
    - Storage pool capacity
    - Delegated space utilization
- Storage Pools and Group Members:**
  - Total group members:** 1
  - Storage pool default:** Capacity 3.13 TB (100.0% free)
  - Members:** member01

The interface also includes a navigation sidebar on the left, a top status bar with user information (Account: grpadmin, Logged in 5/18/06 3:59:44 PM), and a bottom status bar indicating 'No outstanding alarms'.

## Using the CLI to Set the RAID Policy

To access the CLI, establish a telnet or SSH connection to the group IP address or use a serial connection to the array, as described in *Step 1-F* on page 15. When prompted, log in to the group by entering the `grpadmin` account name and the password that you specified when creating the group.

To set the RAID policy for a member, use the following command format:

```
member select member_name raid-policy raid_policy
```

The `raid_policy` variable can be one of the following:

- **RAID-10** – Striping on top of multiple RAID 1 (mirrored) sets, with one or two spare disks. RAID-10 provides good performance for random writes, in addition to the highest availability. However, since the disks are mirrored, RAID 10 provides the least capacity.
- **RAID-50** – Striping on top of two RAID 5 (distributed-parity) sets, with one or two spare disks. RAID-50 provides a good balance of performance (especially for sequential writes), availability, and capacity.
- **RAID-5** – One RAID 5 set, with one spare disk. RAID-5 is similar to RAID-50, with more capacity (two additional disks) but lower availability and performance.

- `raid10-nospares` – Striping on top of multiple RAID 1 sets, with no spares, if possible. This policy should be used only at installations where extra disks and personnel are available at all times to replace failed disks.

**Note:** This option is available only with the CLI.

- `raid50-nospares` – Striping on top of two RAID 5 sets, with no spares, if possible. This policy should be used only at installations where extra disks and personnel are available at all times to replace failed disks.

**Note:** This option is available only with the CLI.

For example, the following command specifies a RAID policy of RAID-50 for a member:

```
> member select member01 raid-policy raid50
```



## Step 4. Create a Volume

---

After setting the RAID policy for a member, you can create one or more volumes. For each volume, you must specify:

- **Name.** Unique name used to manage the volume, up to 64 characters. Valid characters include letters, numbers, periods, hyphens, and colons.
- **Size.** Amount of group space to allocate to the volume.

Optionally, you can override the following default snapshot settings for the volume:

- **Snapshot reserve.** Amount of group space, as a percentage of the volume size, to reserve for snapshots. The default is 100 percent of the volume size.
- **Warning alarm.** By default, an alarm is generated when the amount of free snapshot space is less than 10 percent of the total reserved snapshot space.
- **Snapshot space recovery policy.** Action to take automatically when the volume's reserved snapshot space has been exceeded: either delete the oldest snapshot (default) or put the volume and all its snapshots offline.

In addition, you must create **access control records** to allow authorized hosts access to a volume, while denying other hosts access. A volume and its snapshots share a list of records (up to 16).

An access control record can apply to the volume, its snapshots, or both. For example, you may want to give one host access to both the volume and its snapshots and give another host access only to the volume snapshots.

In each access control record, you can specify an IP address, iSCSI initiator name or CHAP user name (or any combination of the three). To access a volume or snapshot, a host must exactly meet *all* the requirements in one access control record.

## Using the GUI to Create a Volume

To start the GUI, specify the group IP address in a Web browser. When prompted, log in to the group by entering the `grpadmin` account name and the password that you specified when creating the group. The Group Summary window appears, displaying the current group configuration and storage pool capacity.

### Group Summary – No Volumes

The screenshot displays the EqualLogic Group Summary GUI for group `group01`. The interface includes a navigation tree on the left with options like Group Configuration, Monitoring, Events, Storage Pools, Members, Volumes, Volume Collections, and Replication Partners. The main content area is divided into several sections:

- Group Information:**

General Settings	Volumes	Snapshots	Collections
Group name: group01	Volumes: 0	Snapshots: 0	Volume collections: 0
IP address: 172.17.128.175	Online: 0	Online: 0	Snapshot collections: 0
Location: default	In use: 0	In use: 0	Custom snapshot collections: 0
- Group Disk Space:**

Total group capacity 3.13 TB

  - Used by volumes 0 MB (0.0%)
  - Reserved for snapshots 0 MB (0.0%)
  - Reserved for replication 0 MB (0.0%)
  - Delegated space 0 MB (0.0%)
  - Free space 3.13 TB (100.0%)
- Storage Pools and Group Members:**

Total group members: 1

Storage pool default	Capacity 3.13 TB (100.0% free)	member01

The bottom status bar indicates "No outstanding alarms".

**Note:** To obtain GUI and CLI help from the EqualLogic website, click **Tools** in the bottom left corner of the GUI and then click **Online Help**. You can also copy the help files from the PS Series documentation CD-ROM to the system running the Web browser and then specify a local online help location by clicking **User Preferences** in the **Tools** menu.

To create a volume, click **Create volume** in the **Activities** panel. The **Create Volume – General Settings** dialog box appears. Enter the following:

- **Volume name** – Unique name, up to 64 alphanumeric characters (including periods, hyphens, and colons).
- **Volume size** – Be sure to select the correct unit (by default, gigabytes).
- **Snapshot reserve** – Amount of snapshot space to reserve for the volume (by default, 100% of the volume size). To change the snapshot space warning threshold and snapshot space recovery policy, you must modify the volume.

The values in the storage pool space table in the dialog box reflect the specified volume size and snapshot reserve size.

### Create Volume – General Settings

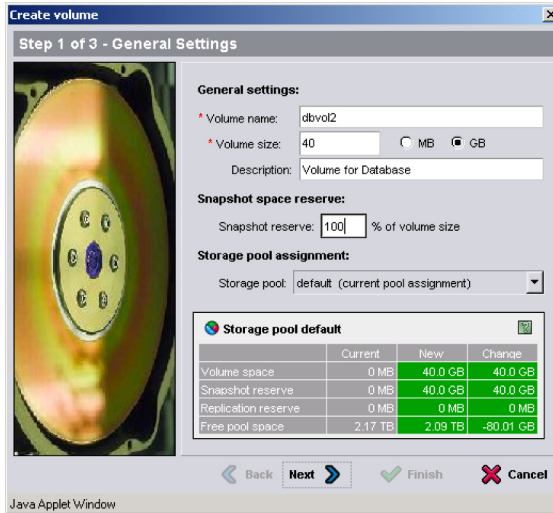

Click **Next** to display the Create Volume – iSCSI Access dialog box. Specify the IP address, CHAP user name, or iSCSI initiator name to which the volume will be restricted. In the following dialog box, volume access is restricted to IP address 172.17.1.40. You can set up more access controls after creating the volume.

### Create Volume – iSCSI Access

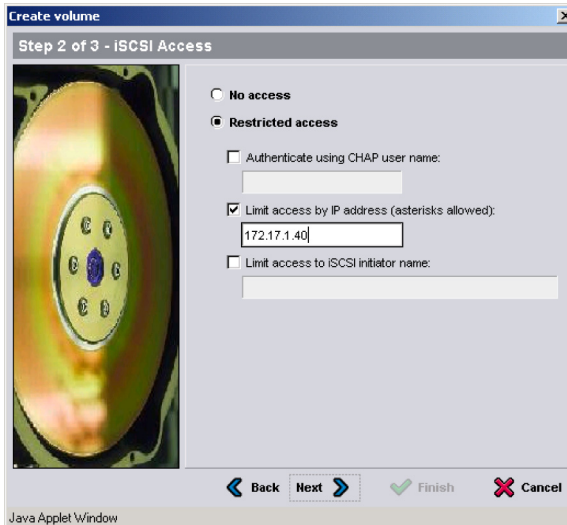

Click **Next** to display the Create Volume – Summary dialog box. If the volume configuration is satisfactory, click **Finish** to create the volume.

### Create Volume – Summary

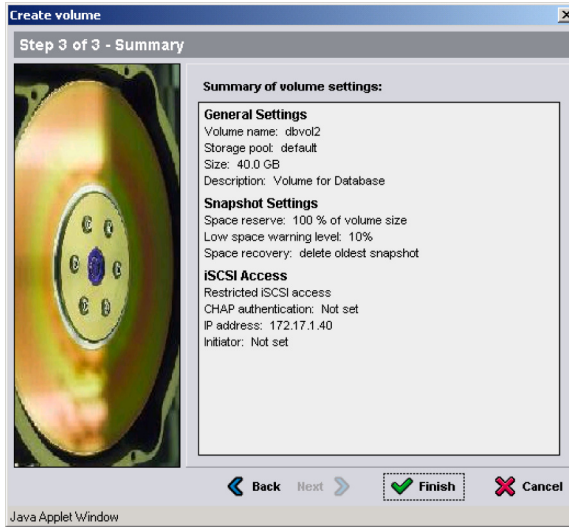

Once you create a volume, you can create snapshots of the volume or perform other tasks. The following window shows a group with volumes and snapshots.

### Group Summary – With Volumes

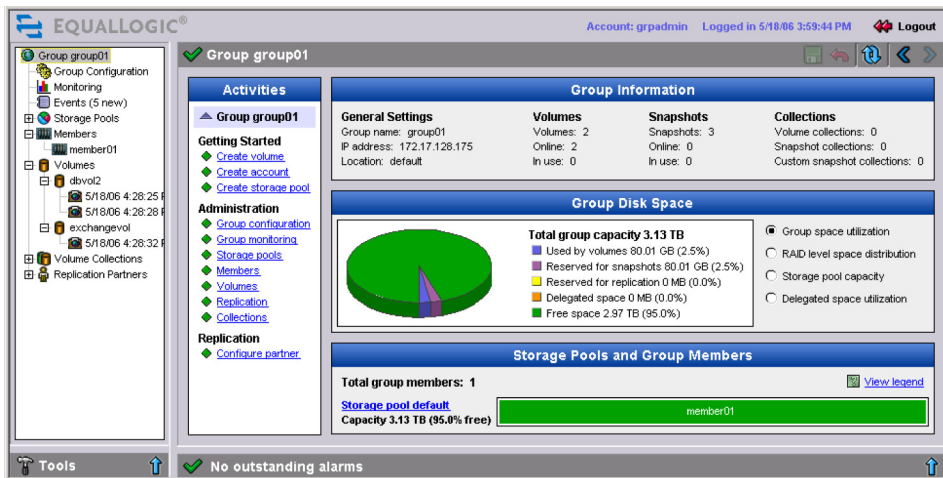

## Using the CLI to Create a Volume

To access the CLI, establish a telnet or SSH connection to the group IP address or use a serial connection to the array, as described in *Step 1-F* on page 15. When prompted, log in to the group by entering the `grpadmin` account name and the password that you specified when creating the group.

To create a volume, use the following command format:

```
volume create volume_name size[GB] [option]
```

Specify the volume name and size (the default is megabytes).

Optionally, specify one or more of the following for the *option* variable:

- `snap-reserve percent_volume_size`
- `snap-depletion delete-oldest | volume-offline`
- `snap-warn percent_reserve_size`
- `unrestricted`

The `unrestricted` option sets no restrictions on host access to the volume, which is not recommended. Instead, to restrict host access to the volume, create one or more access control records using the following command format:

```
volume select volume_name access create access_control
```

The *access\_control* variable can be one or more of the following:

- `initiator initiator_name`
- `ipaddress ip_address`
- `username chap_username authmethod chap`

The following example creates a 50 GB volume and two access control records for the volume. Only a host that has IP address 112.15.7.119 or 112.15.12.120 will be able to access the volume and its snapshots.

```
> volume create staff1 50GB
> volume select staff1 access create ipaddress 112.15.7.119
> volume select staff1 access create ipaddress 112.15.12.120
```

## Step 5. Connect to the Volume from a Host System

A PS Series group volume is seen on the network as an **iSCSI target**. When you create a volume, its iSCSI target name is generated automatically. An example of an iSCSI target name for a volume named `dbvol` is as follows:

```
iqn.2001-05.com.equallogic.5-4a0900-2f00000-007eca92d654f160-dbvol
```

To display the iSCSI target name for a volume, do either of the following:

- In the CLI, enter the command: `volume show volume_name`
- In the GUI, select the volume name in the far left panel and then click the `Status` tab to display the iSCSI target name at the bottom of the iSCSI Connections panel.

To connect to a volume, the host must have an **iSCSI initiator** running and must match the security credentials in one of the volume's access control records. Hardware and software initiators are available from a variety of vendors. Configure your initiator using the instructions provided by the vendor.

**Note:** It is *strongly* recommended that you visit the EqualLogic Customer Support website to obtain important information about using initiators to access PS Series group volumes.

The exact procedure for connecting to an iSCSI target depends on the initiator. See the initiator documentation for details. In most cases, you use the initiator configuration utility to specify the group IP address as either the **target portal** or the **discovery address**. If the initiator supports the discovery process, it will return a list of iSCSI targets (volumes) that the host can access.

If the initiator does not support discovery, you must also specify the target name. The standard iSCSI port number (3260) may also be required.

Using the initiator configuration utility, select the desired target and log in or connect to the target. If the volume's access control records use CHAP for initiator authentication, enter the CHAP credentials (user name and password or "secret") at this time. Note that CHAP must already be set up in the group, as described in the PS Series *Group Administration* manual.

Once the host connects to the iSCSI target, the volume is seen by the host as a regular disk that can be formatted using the normal operating system utilities. For example, you can partition the disk and create a file system, if desired.

## Advanced Operations and More Information

After getting started, you can customize a PS Series group and also utilize the full set of product features and host-based solutions.

You can also obtain technical support. For more information, see *Product Documentation and Technical Support* on page vi.

The following table lists advanced operations. These group, volume, and member tasks are fully documented in the *Group Administration* manual.

### Advanced Operations

Group Task	Description
Add a member.	Although a one-member group is fully functional, adding more arrays expands storage pool capacity, increases network bandwidth, and improves overall group performance—without disrupting data availability.
Modify the date, time, or time zone or configure NTP.	Group time is based on the clock on the first member, which is set at the factory. The default time zone is EST. You can also configure the group to use an NTP server.
Create administration accounts.	The <code>grpadmin</code> account is the default administration account. You can set up additional accounts.
Set up event notification.	To be informed of significant events in a timely manner, set up e-mail or syslog notification.
Configure iSNS.	To automate iSCSI target discovery, you can configure the group to use an iSNS server.
Configure CHAP.	You can use CHAP to restrict host access to volumes. Both initiator and target CHAP authentication are supported.
Configure SNMP.	To monitor traps from the group, you can use SNMP.
Create pools.	With multi-member groups, you can create additional pools and assign members and volumes to the pools.

**Advanced Operations (Continued)**

<b>Volume Task</b>	<b>Description</b>
Create access control records for a volume.	An access control record specifies the criteria that a host must meet in order to access the volume.
Create snapshots of a volume.	Snapshots are point-in-time copies of volume data that can be used for backups.
Set up replication across different groups.	Replicas are point-in-time copies of volume data that are stored separately from volumes for disaster recovery.
Clone a volume, snapshot, or replica.	Cloning creates a new volume in the group where the cloned volume, snapshot, or replica resides.
Promote a replica set.	Promotion stops replication, creates a new volume, and transforms the replicas into corresponding snapshots.
Create collections.	Collections provide a way to group multiple related volumes together for the purpose of creating snapshots or replication. The administrator can create a multi-volume snapshot or replica in a single operation or through a single schedule.
<b>Member Task</b>	<b>Description</b>
Add network connections.	Multiple connections provide performance and availability.
Add disks.	Adding disks increases capacity.







# Index

---

## A

access control records, using 25

### array

- adding to a group 16
- configuration prompts 16
- configuring 16
- console connection 15
- creating a group 16
- documentation vi
- environment requirements 6
- LED descriptions 12
- maximum network configuration 11
- network address 16
- network connection guidelines 9
- network recommendations 9
- network requirements 9
- password for logging in 17
- power requirements 6
- power supply connections 8
- powering on 12
- rack mounting 6
- serial connection 15
- setting the RAID policy 19
- steps for setting up and using 2
- unpacking 3
- warranty vii

## C

### CHAP

- specifying host credentials 30
- using access control records 30

CLI, accessing 23

collections, defined 32

console connection (serial) 15

### control modules

- connecting cables 9
- network connections 9

## D

default gateway (member) 16

documentation, array vi

## F

Flow Control recommendation 10

## G

Gigabit Ethernet recommendation 9

### group

- accessing the CLI from a host 23
- accessing the GUI from a host 19
- accessing volumes from a host 30
- advanced operations 31
- configuration prompts 17
- creating 16
- creating volumes 25
- customizing 31
- defined 1
- increasing capacity 2
- IP address 17
- name 17
- network recommendations 9
- network requirements 9
- online help 26
- password for adding members 17
- password for managing 17

GUI, accessing 19

**H**

## hardware

- console connection 15
- environment requirements 6
- LED descriptions 12
- network connections 9
- power supply connections 8
- powering on array 12
- rack mounting array 6
- required 4, 5
- serial connection 15
- setting up 3
- shipping box contents 3, 4
- unpacking 3

## hosts

- accessing CLI 23
- accessing GUI 19
- accessing volumes 25
- connecting to volumes 30
- Flow Control recommendation 10
- Jumbo Frames recommendation 10
- restricting access 25
- specifying CHAP credentials 30

**I**

## initiator (iSCSI)

- accessing a volume 30
- defined 1
- host requirements 30

**J**

Jumbo Frames recommendation 10

**L**

LEDs, location and description 12

**M**

## member

- adding to a group 16
- configuring 16
- defined 1
- increasing bandwidth 9
- increasing capacity 2
- multipath I/O recommendation 10
- network address 16
- network cable requirement 9
- network connection guidelines 9
- network connection requirement 9
- setup prompts 16
- subnet access recommendation 10

**N**

netmask (member) 16

## network

- array IP address 16
- cables 9
- connecting arrays 9
- connection guidelines 9
- group IP address 17
- improving performance 9
- maximum configuration 11
- recommendations 9
- requirements 9

## network interfaces

- connecting 11
- description 9

**O**

online help, accessing 26

**P**

- passwords
  - for adding a member 17
  - for logging in to group 17
- power supplies
  - connecting array 8
  - turning on 12
  - using UPS systems 8
- product return requirements 4

**R**

- rack mounting array
  - four-pole rack 6
  - two-pole rack 6

RAID 10, defined 21

RAID 5, defined 21

RAID 50, defined 21

RAID policy, setting 19

**S**

- serial connection, setting up 4, 15
- setup utility
  - array configuration prompts 16
  - creating a group 16
  - example of creating a group 18
  - group configuration prompts 17
- shipping box contents 3, 4
- Spanning-Tree recommendation 10
- spares
  - set as part of RAID policy 19

storage pools, defined 1

- switches, recommendations
  - Flow Control 10
  - Jumbo Frames 10
  - Spanning-Tree 10
  - unicast storm control 10
  - VLAN 10

**T**

- target (iSCSI)
  - connecting to 30
  - defined 1
  - obtaining name 30

**U**

unicast storm control recommendation 10

UPS systems, using for availability 8

**V**

VLAN recommendation 10

volumes

- accessing from a host 30
- connecting to 30
- creating 25
- defined 1
- requirements 25
- restricting access 25
- snapshot settings 25
- target name for 30

**W**

warranty, array vii





9 Townsend West, Nashua, NH 03063  
Tel 603.579.9762 / Fax 603.579.6910 / [www.equallogic.com](http://www.equallogic.com)

