

studio<sub>xps</sub><sup>™</sup>

SETUP GUIDE

**DELL**<sup>™</sup>

YOURS IS HERE



**studio** xps™

**SETUP GUIDE**

Model PP35L

## Notes, Cautions, and Warnings



**NOTE:** A NOTE indicates important information that helps you make better use of your computer.



**CAUTION:** A CAUTION indicates either potential damage to hardware or loss of data and tells you how to avoid the problem.



**WARNING:** A WARNING indicates a potential for property damage, personal injury, or death.

---

Information in this document is subject to change without notice.

© 2010 Dell Inc. All rights reserved.

Reproduction of these materials in any manner whatsoever without the written permission of Dell Inc. is strictly forbidden.

Trademarks used in this text: *Dell*, the *DELL* logo, *Studio XPS*, *Solution Station*, and *DellConnect* are trademarks of Dell Inc.; *Intel* is a registered trademarks and *Core* is a trademark of Intel Corporation in U.S. and other countries; *Microsoft*, *Windows*, *Windows Vista*, and the *Windows Vista* start button logo are either trademarks or registered trademarks of Microsoft Corporation in the United States and/or other countries; *Blu-ray Disc* is a trademark of the Blu-ray Disc Association; *Bluetooth* is a registered trademark owned by Bluetooth SIG, Inc. and is used by Dell under license.

Other trademarks and trade names may be used in this document to refer to either the entities claiming the marks and names or their products. Dell Inc. disclaims any proprietary interest in trademarks and trade names other than its own.

March 2010

P/N PF42Y

Rev. A00

# Contents

<b>Setting Up Your Studio XPS Laptop</b> . . . . .	<b>5</b>	Left Side Features . . . . .	20
Before Setting Up Your Computer . . . . .	5	Display Features . . . . .	22
Connecting the AC Adapter . . . . .	6	Media, Wireless, and Power Controls . . . . .	23
Connecting the Network Cable (Optional) . . . . .	6	Computer Base and Keyboard Features . . . . .	24
Turning on Your Computer . . . . .	7	Using the Optical Drive . . . . .	26
Using the Wireless Button . . . . .	7	Removing and Replacing the Battery . . . . .	27
Set Up Microsoft Windows . . . . .	8	Software Features . . . . .	28
Create System Recovery Media (Recommended) . . . . .	8	Dell Dock . . . . .	29
Connecting to the Internet (Optional) . . . . .	9	Dell DataSafe Online Backup . . . . .	30
Setting Up the TV Tuner (Optional) . . . . .	12	<b>Solving Problems</b> . . . . .	<b>31</b>
Setting Up the 5.1 Audio Connections (Optional) . . . . .	13	Network Problems . . . . .	31
<b>Using Your Studio XPS Laptop</b> . . . . .	<b>14</b>	Power Problems . . . . .	32
Device Status Lights . . . . .	14	Memory Problems . . . . .	34
Right Side Features . . . . .	16	Lockups and Software Problems . . . . .	34

## Contents

<b>Using Support Tools</b> .....	<b>37</b>	Returning Items for Repair Under Warranty or for Credit.....	56
Dell Support Center.....	37	Before You Call.....	57
My Dell Downloads.....	38	Contacting Dell.....	58
System Messages.....	38		
Hardware Troubleshooter.....	40	<b>Finding More Information and Resources</b> .....	<b>60</b>
Dell Diagnostics.....	41	<b>Basic Specifications</b> .....	<b>62</b>
<b>Restoring Your Operating System</b> .....	<b>45</b>	<b>Appendix</b> .....	<b>73</b>
System Restore.....	46	Macrovision Product Notice.....	73
Dell DataSafe Local Backup.....	47		
System Recovery Media.....	49	<b>Index</b> .....	<b>74</b>
Dell Factory Image Restore.....	50		
<b>Getting Help</b> .....	<b>52</b>		
Technical Support and Customer Service.....	53		
DellConnect™.....	53		
Online Services.....	54		
Automated Order-Status Service.....	55		
Product Information.....	55		

# Setting Up Your Studio XPS Laptop

This section provides information to help you set up your Studio XPS™ 1640/1645/1647 laptop and connect peripherals.

## Before Setting Up Your Computer

When positioning your computer, ensure that you have easy access to a power source, adequate ventilation, and a level surface to place your computer.

Restricting airflow around your computer may cause it to overheat. To prevent overheating ensure that you leave at least 10.2 cm (4 inches) at the back of the computer and a minimum of 5.1 cm (2 inches) on all other sides. You should never place your computer in an enclosed space, such as a cabinet, carrying case, or drawer when it is powered on.



**WARNING:** Do not block, push objects into, or allow dust to accumulate in the air vents. Do not place your Dell™ computer in a low-airflow environment, such as a closed briefcase, or on fabric surfaces, such as carpets or rugs, while it is powered on. Restricting the airflow can damage the computer, deteriorate the computer performance, or cause a fire. The computer turns on the fan when the computer gets hot. Fan noise is normal and does not indicate a problem with the fan or the computer.



**CAUTION:** Placing or stacking heavy or sharp objects on the computer may result in permanent damage to the computer.

## Connecting the AC Adapter

Connect the AC adapter to the computer and then plug it into a wall outlet or surge protector.



**⚠ WARNING:** The AC adapter works with worldwide electrical outlets. However, power connectors and power strips vary among countries. Using an incompatible cable or incorrectly connecting the cable to a power strip or electrical outlet may cause fire or equipment damage.

## Connecting the Network Cable (Optional)

If you plan to use a wired network connection, plug in the network cable.

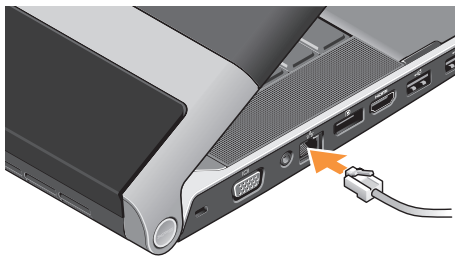



## Turning on Your Computer



To turn on your computer, lightly press the power button  on the center control cover and then release.

## Using the Wireless Button

To turn on wireless, with the computer turned on, lightly touch the wireless symbol  on the center control cover and then release.





This button allows you to quickly turn all of your wireless radios (Bluetooth<sup>®</sup>, Wi-Fi, and WWAN) off, such as when you are asked to disable all wireless radios on an airplane flight. Pressing this button one time turns all of your radios off. Pressing it again returns your wireless radios to their respective states they were in before you pressed the button the first time.

### Set Up Microsoft Windows

Your computer is preconfigured with the operating system you selected at the time of purchase. To set up Microsoft® Windows® for the first time, follow the instructions on the screen. These steps are mandatory and may take some time to complete. The screens will take you through several procedures including accepting license agreements, setting preferences and setting up an Internet connection.

 **CAUTION: Do not interrupt the operating system's setup process. Doing so may render your computer unusable and you will need to reinstall the operating system.**

 **NOTE:** For optimal performance of your computer, it is recommended that you download and install the latest BIOS and drivers for your computer available at [support.dell.com](http://support.dell.com).

 **NOTE:** For more information on the operating system and features, see [support.dell.com/MyNewDell](http://support.dell.com/MyNewDell).

### Create System Recovery Media (Recommended)

 **NOTE:** It is recommended that you create a system recovery media as soon as you set up Microsoft Windows.

The system recovery media can be used to restore your computer to the operating state it was in when you purchased the computer, while preserving data files (without the need of the *Operating System* disc). You can use the system recovery media if changes to the hardware, software, drivers, or other system settings have left the computer in an undesirable operating state.

You will require the following to create the system recovery media:

- Dell DataSafe Local Backup
- USB key with a minimum capacity of 8 GB or DVD-R/DVD+R/Blu-ray Disc™

 **NOTE:** Dell DataSafe Local Backup does not support rewritable discs.

To create a system recovery media:

1. Ensure that the AC adapter is connected (see “Connecting the AC Adapter” on page 6).
2. Insert the disc or USB key in the computer.
3. Click **Start**  → **Programs** → **Dell DataSafe Local Backup**.
4. Click **Create Recovery Media**.
5. Follow the instructions on the screen.

 **NOTE:** For information on using the system recovery media, see “System Recovery Media” on page 49.

## Connecting to the Internet (Optional)

To connect to the Internet, you need an external modem or network connection and an Internet Service Provider (ISP).

If an external USB modem or WLAN adapter is not a part of your original order, you can purchase one at [www.dell.com](http://www.dell.com).

### Setting Up a Wired Connection

- If you are using a dial-up connection, connect the telephone line to the optional external USB modem and to the telephone wall connector before you set up your Internet connection.
- If you are using a DSL or cable/satellite modem connection, contact your ISP or cellular telephone service for setup instructions.

To complete setting up your wired Internet connection, follow the instructions in “Setting Up Your Internet Connection” on page 10.

## Setting Up Your Studio XPS Laptop

### Setting Up a Wireless Connection

 **NOTE:** To set up your wireless router, see the documentation that shipped with your router.

Before you can use your wireless Internet connection, you need to connect to your wireless router.

To set up your connection to a wireless router:

#### *Windows® 7*

1. Ensure that wireless is enabled on your computer (see “Using the Wireless Button” on page 7).
2. Save and close any open files, and exit any open programs.
3. Click **Start**  → **Control Panel**.
4. In the search box, type `network`, and then click **Network and Sharing Center** → **Connect to a network**.
5. Follow the instructions on the screen to complete the setup.

#### *Windows Vista®*

1. Ensure that wireless is enabled on your computer (see “Using the Wireless Button” on page 7).
2. Save and close any open files, and exit any open programs.
3. Click **Start**  → **Connect To**.
4. Follow the instructions on the screen to complete the setup.

### Setting Up Your Internet Connection

ISPs and ISP offerings vary by country. Contact your ISP for offerings available in your country.

If you cannot connect to the Internet but have successfully connected in the past, the ISP might have a service outage. Contact your ISP to check the service status, or try connecting again later.

Have your ISP information ready. If you do not have an ISP, the **Connect to the Internet** wizard can help you get one.

To set up your Internet connection:

### *Windows 7*

1. Save and close any open files, and exit any open programs.
2. Click **Start**  → **Control Panel**.
3. In the search box, type `network`, and then click **Network and Sharing Center** → **Set up a new connection or network** → **Connect to the Internet**.

The **Connect to the Internet** window appears.

-  **NOTE:** If you do not know which type of connection to select, click **Help me choose** or contact your ISP.
4. Follow the instructions on the screen and use the setup information provided by your ISP to complete the setup.

### *Windows Vista*

1. Save and close any open files, and exit any open programs.
2. Click **Start**  → **Control Panel**.
3. In the search box, type `network`, and then click **Network and Sharing Center** → **Set up a connection or network** → **Connect to the Internet**.

The **Connect to the Internet** window appears.

-  **NOTE:** If you do not know which type of connection to select, click **Help me choose** or contact your ISP.
4. Follow the instructions on the screen and use the setup information provided by your ISP to complete the setup.

### Setting Up the TV Tuner (Optional)

 **NOTE:** Availability of the TV tuner may vary by region.

You can set up the TV Tuner through the Media Center.

#### To set up the TV Tuner for the first time:

Follow this procedure if you are launching the Media Center for the first time.

Double-click the Media Center icon on the desktop.

- Select **Express setup**,
  - Go to **Main Menu**→ **Tasks**→ **Settings**→ **TV**→ **Set up TV Signal**→ **Confirm Your Region** and follow the instructions given.
  - Go to **Main Menu**→ **TV + Movies**→ **Set up TV**→ **Confirm Your Region** and follow the instructions given.

- Select **Custom setup**,
  - Follow the instructions given.
  - In the **Optional Setup** screen, choose **Configure tuners, TV signal, and Guide**.
  - Click **Next** and confirm your region.

#### To re-setup the TV Tuner, if required:

Follow this procedure if you have launched Media Center previously.

1. Double-click the Media Center icon on the desktop.
2. Go to **Main Menu**→ **Tasks**→ **Settings**→ **TV**→ **Set up TV Signal**→ **Confirm Your Region**.

## Setting Up the 5.1 Audio Connections (Optional)

To set up the 5.1 audio connections:

Click **Start**  → **Control Panel** → **Additional Options**. Run **IDT Audio Control Panel**. In the **Jacks** tab, there are three connector icons.

Follow the instructions to finish the setup.

1. Click the microphone icon, select **Device: Rear Speakers**, and plug your rear speaker cable to the audio in/microphone connector.
2. Click the middle headphone icon, select **Device: Center/LFE Speaker**, and plug your center/woofer speaker cable to the middle audio out/headphone connector.
3. Click the right headphone icon, select **Device: Front Speaker**, and plug your front speaker cable to the right audio out/headphone connector.

# Using Your Studio XPS Laptop

Your computer has several indicators, buttons, and features that provide information at-a-glance and time-saving shortcuts for common tasks.

## Device Status Lights

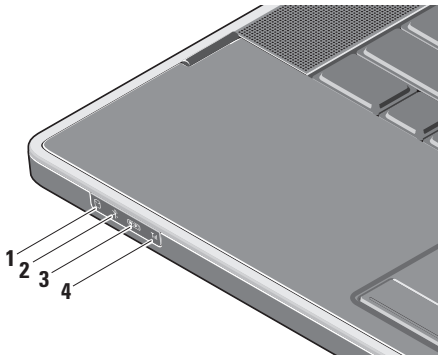

- 1  **Hard drive activity light** – Turns on when the computer reads or writes data. A flashing light indicates hard drive activity.

 **CAUTION: To avoid loss of data, never turn off the computer while the hard drive activity light is flashing.**

- 2  **Bluetooth® status light (optional)** – Turns on when Bluetooth wireless is enabled.

To turn on wireless, with the computer turned on, lightly touch the wireless symbol (A) on the center control cover and then release.

 **NOTE:** Bluetooth wireless technology is an optional feature.



To turn off Bluetooth wireless, either press the wireless symbol or right-click the Bluetooth icon in the notification area of your desktop, and click **Disable Bluetooth Radio**.

- 3  **WiFi status light** – Turns on when the internal WLAN is enabled.

To turn on wireless, with the computer turned on, lightly touch the wireless symbol  on the center control cover and then release.

- 4  **WWAN status light** – Turns on when WWAN is enabled.

To turn on wireless, with the computer turned on, lightly touch the wireless symbol  on the center control cover and then release.

## Right Side Features

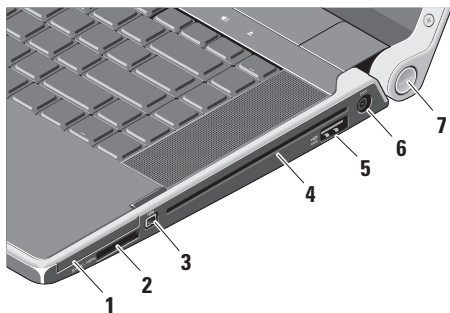

- 1 **EC** **ExpressCard slot** – Supports one ExpressCard.

 **NOTE:** Your computer ships with a plastic blank installed in the ExpressCard slot. Blanks protect unused slots from dust and other particles. Save the blank for use when no ExpressCard is installed in the slot; blanks from other computers may not fit your computer.

- 2 **SD/MMC - MS/Pro - xD**

**8-in-1 Media Card Reader** – Provides a fast and convenient way to view and share digital photos, music, videos, and documents stored on the following digital memory cards:

- Secure digital (SD) memory card
- Secure Digital High Capacity (SDHC) card
- Secure Digital Input/Output (SDIO) card
- Multi Media Card (MMC)
- Memory Stick
- Memory Stick PRO
- xD-Picture Card (type - M and type - H)
- Hi Density-SD

 **NOTE:** Your computer ships with a plastic blank installed in the media card slot. Blanks protect unused slots from dust and other particles. Save the blank for use when no media card is installed in the slot. Blanks from other computers may not fit your computer.

- 3  **IEEE 1394 connector** – Connects to high-speed serial multimedia devices, such as digital video cameras.
- 4 **Optical Drive** – Plays or burns only standard-size and shape (12 cm) CDs, and DVDs. Ensure that the side with print or writing is facing upward when inserting discs.

 **NOTE:** Do not use non-standard-size or shape discs (including mini-CDs and mini-DVDs) as you will damage the drive.

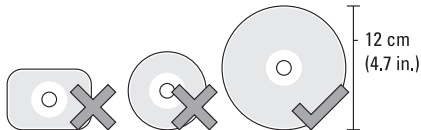

- 5  **eSATA/USB combo connector with USB PowerShare** – Connects to eSATA compatible storage devices (such as external hard drives or optical drives) or USB devices (such as a mouse, keyboard, printer, external drive, or MP3 player).

This connector can also be used for charging USB devices when the computer is powered on/off or in sleep state. This function may not work with certain external USB devices when the computer is in powered off or sleep state, even if they are compliant with the USB specification. In such cases, turn the computer on to charge the device.

 **NOTE:** If the computer is turned off or in sleep state while the USB device is charging, unplug the USB device and plug it in again to continue charging the device.

 **NOTE:** The USB PowerShare will be automatically shut off when only 10% of the total battery life remains.

- 6  **AC adapter connector** – Connects to the AC adapter which powers the computer and charges the battery.

**7 Power light** – Illuminates when the computer is turned on. The different lights indicate the following:

*On Battery Power:*

- Solid white - computer is running on battery power
- Solid amber - battery is low
- Flashing amber - battery is critically low
- Blinking white - computer is in sleep state

*On AC Adapter:*

- Solid white - computer is powered on and battery is charged
- Blinking white - computer is in standby state

## Left Side Features

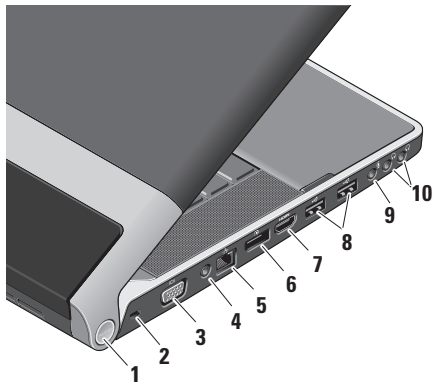

**1 Power light** – Illuminates when the computer is turned on. The different lights indicate the following:

### *On Battery Power:*









- Solid white - computer is running on battery power
- Solid amber - battery is low
- Flashing amber - battery is critically low
- Blinking white - computer is in sleep state

### *On AC Adapter:*

- Solid white - computer is powered on and battery is charged
- Blinking white - computer is in standby state

**2 Security cable slot** – Attaches a commercially available antitheft device to the computer.

 **NOTE:** Before you buy an antitheft device, ensure that it fits into the security cable slot on your computer.

- 3  **VGA connector** – Connects to a monitor or projector.
- 4 **Antenna-in connector (on supported models)** – Connects to an external antenna, through a MCX connector, to view programs using the TV Tuner card (optional). For more details on the TV Tuner card setup see “Setting up the TV Tuner (Optional)” on page 12.
- 5  **Network connector** – If you are using a cabled network signal, this connects your computer to a network or broadband device.
- 6  **DisplayPort connector** – Digital interface standard connector that supports external DisplayPort monitors and projectors.
- 7  **HDMI connector** – Connects to a TV for both 5.1 audio and video signals.  
 **NOTE:** When used with a monitor, only the video signal will be read.
- 8  **USB connectors (2)** – Connect to USB devices, such as a mouse, keyboard, printer, external drive, or MP3 player.
- 9  **Audio-in/Microphone connector** – Connects to a microphone or input signal for use with audio programs.
- 10  **Audio-out/Headphone connectors (2)** – Connect one or two pairs of headphones, or send audio to a powered speaker or sound system. The audio signal is the same for both connectors.

### Display Features

The display panel holds a camera and accompanying dual digital array microphones.

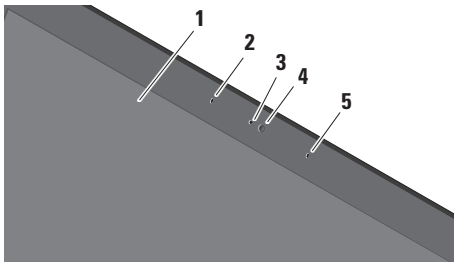

- 1 Display** – Your display can vary based on selection you made when purchasing your computer. For more information about displays, see the *Dell Technology Guide*.
- 2 Left digital array microphone** – Combines with the right digital array microphone to provide high quality sound for video chatting and voice recording.

- 3 Camera activity light** – Illuminates when the camera is on.
- 4 Camera** – Built-in camera for video capture, conferencing, and chat. The camera may have an advanced facial recognition software based on the selection you made while purchasing your computer.

#### **FastAccess Facial Recognition**

**(Optional)** – Helps to keep your computer secure. This optional facial recognition software learns and recognizes your face each time you login to your computer, minimizing the need to manually login using passwords. For more information, click **Start**  → **Programs** → **FastAccess**.

- 5 Right digital array microphone** – Combines with the left digital array microphone to provide high quality sound for video chatting and voice recording.



## Media, Wireless, and Power Controls

To use the media, wireless, and power controls, lightly touch the symbol and then release. The control's symbol will shine for 2 seconds to confirm your selection then fade away.



Turn on power, or wake up from sleep state



Turn on wireless



Play the previous track or chapter



Stop



Play or pause



Play the next track or chapter



Mute the sound



Turn down the volume



Turn up the volume



Eject the disc

## Computer Base and Keyboard Features

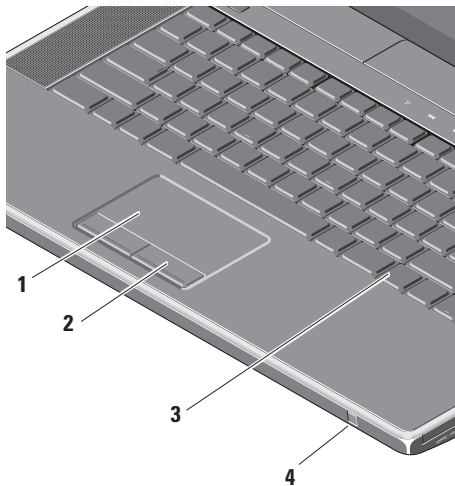

- 1 Touch pad** – Provides the functionality of a mouse to move the cursor, drag or move selected items, and left-click by tapping the surface.

It supports circular scrolling and zoom. To change the circular scrolling and zoom settings, double-click the **Dell Touch pad** icon in the notification area of your desktop.

In the **Scrolling** tab, enable or disable scrolling or circular scrolling, choose the scroll zone width and scroll speed.

In the **Gestures** tab, enable or disable the one-finger zoom (zoom in and out moving the finger upward or downward) or the pinch zoom (zoom in and out by spreading two fingers or by bringing the two fingers together).

**2 Touch pad buttons** – Provide left- and right-click functions like those on a mouse.

**3 Backlit Keyboard** – The backlit keyboard provides visibility in dark environments by illuminating all symbols on the keys. For more information on the keyboard, see *Dell Technology Guide*.

**Backlit Keyboard/Touch Pad Brightness Settings** – Press <Fn> + right-arrow key to toggle between the three lighting states (in the given order).

The three lighting states are:

- a. full keyboard/touch pad brightness (default setting)
- b. no lighting
- c. half keyboard/touch pad brightness

**4 Consumer IR** – Allows certain software applications to be controlled by the Dell Travel Remote (an optional device that can be stored in the ExpressCard slot when not in use).

## Using the Optical Drive

**⚠ CAUTION:** Do not use non-standard-size or shape discs (including mini-CDs and mini-DVDs) as you will damage the drive.

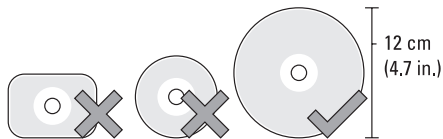

**✍ NOTE:** Do not move the computer while playing or recording CDs and DVDs.

Place the disc in the center of the disc slot, with the label facing upwards and gently push the disc into the slot. The drive will automatically pull the disc in and begin reading its content.



To eject a disc from the drive, gently touch the eject control . The control will flash for a few seconds to confirm before ejecting the disc.

## Removing and Replacing the Battery

**⚠ WARNING:** Using an incompatible battery may increase the risk of fire or explosion. This computer should only use a battery purchased from Dell. Do not use batteries from other computers.

**⚠ WARNING:** Before removing the battery, shut down the computer, and remove external cables (including the AC adapter).

To remove the battery:

1. Shut down the computer and turn it over.
2. Slide the battery release latch towards the side of the computer and hold it in place.
3. Slide the battery out.

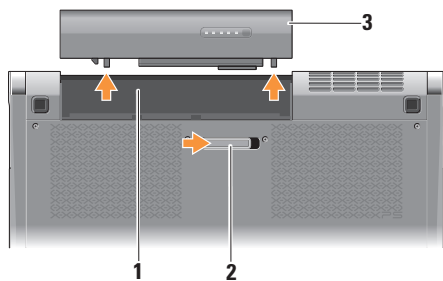

- 
- 1 Battery bay
  - 2 Battery release latch
  - 3 Battery
- 

To replace the battery, slide it into the bay until it clicks into place.

### Software Features

 **NOTE:** For more information about the features described in this section, see the *Dell Technology Guide* on your hard drive or at [support.dell.com](http://support.dell.com).

#### Productivity and Communication

You can use your computer to create presentations, brochures, greeting cards, fliers, and spreadsheets. You can also edit and view digital photographs and images depending on the applications installed in your computer. Check your purchase order for software installed on your computer.

After connecting to the Internet, you can access websites, setup an e-mail account, upload and download files, and so on.

#### Entertainment and Multimedia

You can use your computer to watch videos, play games, create your own CDs, listen to music and internet radio stations. Your optical disc drive may support multiple disc media formats including CDs and DVDs.

You can download or copy pictures and video files from portable devices, such as digital cameras and cell phones. Optional software applications enable you to organize and create music and video files that can be recorded to disc, saved on portable products such as MP3 players and handheld entertainment devices, or played and viewed directly on connected TVs, projectors, and home theater equipment.

## Dell Dock

The Dell Dock is a group of icons that provides easy access to frequently-used applications, files, and folders. You can personalize the Dock by:

- Adding or removing icons
- Changing the color and location of the Dock
- Grouping related icons into categories
- Changing the behavior of the icons



### Add a Category

1. Right-click the Dock, click **Add**→ **Category**. The **Add/Edit Category** window is displayed.
2. Enter a title for the category in the **Title** field.
3. Select an icon for the category from the **Select an image:** box.
4. Click **Save**.

### Add an Icon

Drag and drop the icon to the Dock or a category.

### Remove a Category or Icon

1. Right-click the category or icon on the Dock and click **Delete shortcut** or **Delete category**.
2. Follow the instructions on the screen.

### Personalize the Dock

1. Right-click the Dock and click **Advanced Setting...**
2. Choose the desired option to personalize the Dock.

### Dell DataSafe Online Backup

 **NOTE:** Dell DataSafe Online may not be available in all regions.

 **NOTE:** A broadband connection is recommended for fast upload/download speeds.

Dell DataSafe Online is an automated backup and recovery service that helps protect your data and other important files from catastrophic incidents like theft, fire, or natural disasters. You can access the service on your computer using a password-protected account.

For more information, go to **[delldatasafe.com](http://delldatasafe.com)**.

To schedule backups:

1. Double-click the Dell DataSafe Online icon  on the taskbar.
2. Follow the instructions that appear on the screen.



# Solving Problems

This section provides troubleshooting information for your computer. If you cannot solve your problem using the following guidelines, see “Using Support Tools” on page 37 or “Contacting Dell” on page 58.

 **WARNING: Only trained service personnel should remove the computer cover. See the *Service Manual* at [support.dell.com](http://support.dell.com) for advanced service and troubleshooting instructions.**

## Network Problems

### Wireless Connections

#### If the wireless network connection is lost

- The wireless button may have been unintentionally pressed, deactivating your wireless connections. To turn on wireless, with the computer turned on, lightly touch the wireless symbol  on the center control cover and then release. You can manage the Wireless LAN using *Dell Wireless WLAN Card Utility* from your taskbar. You can also use *Windows Wireless Network Connections*, accessed from Control Panel, to manage Wireless LAN.
- Interference may be blocking or interrupting your wireless connection. Try moving the computer closer to your wireless router.

## Solving Problems

### Wired Connections

#### If the wired network connection is lost

- The cable is loose or damaged.
- Verify both ends of the network cable are connected. Try another network cable, if available.

The link integrity light on the integrated network connector lets you verify that your connection is working and provides information on the status:

- Green — A good connection exists between a 10-Mbps network and the computer.
- Orange — A good connection exists between a 100-Mbps network and the computer.
- Yellow — A good connection exists between a 1000-Mbps network and the computer.
- Off — The computer is not detecting a physical connection to the network.



**NOTE:** The link integrity light on the network connector is only for the wired cable connection. The link integrity light does not provide status for wireless connections.

### Power Problems

The power/battery lights on the hinges indicate the following:

#### *On Battery Power:*

- Solid white - computer is running on battery power
- Solid amber - battery is low
- Flashing amber - battery is critically low

#### *On AC Adapter:*

- Solid white - computer is powered on and battery is charged
- Blinking white - computer is in standby state

**If the power light is off** — The computer is either turned off or is not receiving power.

- Remove the AC adapter and try turning on the computer with only the battery.
- Remove the battery and try turning on the computer with only the AC adapter.
- Check both ends of the AC adapter cable connections. Ensure that the light on the AC adapter is on. If the light is not on, try plugging the AC adapter into another electrical outlet.

**If the power light is solid white and the computer is not responding** — The display may not be responding. Press the power button until the computer turns off and then turn it back on. If the problem persists, see the *Dell Technology Guide* at [support.dell.com](http://support.dell.com).

**If the power light is blinking white** — The computer is in standby mode. Press a key on the keyboard, move the pointer using the touch pad or a connected mouse, or press the power button to resume normal operation.

**If you encounter interference that hinders reception on your computer** — An unwanted signal is creating interference by interrupting or blocking other signals. Some possible causes of interference are:

- power, keyboard, and mouse extension cables
- too many devices connected to a power strip
- multiple power strips connected to the same electrical outlet

### Memory Problems

#### If you experience memory problems —

- Check if the memory module is compatible with your computer. Your computer supports DDR3 memory. For more information about the type of memory supported by your computer, see “Basic Specifications” on page 62.
- Run the Dell Diagnostics (see “Dell Diagnostics” on page 41).
- Reseat the memory modules (see the *Service Manual* at [support.dell.com](http://support.dell.com)) to ensure that your computer is successfully communicating with the memory.

### Lockups and Software Problems

**If the computer does not start up** — Ensure that the power cable is firmly connected to the computer and to the electrical outlet.

**If a program stops responding** — End the program:

1. Press <Ctrl><Shift><Esc> simultaneously.
2. Click **Applications**.
3. Click the program that is no longer responding
4. Click **End Task**.

**If a program crashes repeatedly** — Check the software documentation. If necessary, uninstall and then reinstall the program.



**NOTE:** Software usually includes installation instructions in its documentation or on the disc (CD or DVD).

**If the computer stops responding or a solid blue screen appears —**

 **CAUTION: You might lose data if you are unable to perform an operating system shutdown.**

Turn your computer off. If you are unable to get a response by pressing a key on your keyboard or moving your mouse, press the power button for at least 8 to 10 seconds until your computer turns off and then restart your computer.

**If a program is designed for an earlier Microsoft® Windows® operating system —**

Run the Program Compatibility Wizard. The Program Compatibility Wizard configures a program so that it runs in an environment similar to an earlier version of Microsoft Windows operating system environments.

*Windows® 7*

1. Click **Start**  → **Control Panel** → **Programs** → **Run programs made for previous versions of Windows**.
2. In the welcome screen, click **Next**.
3. Follow the instructions on the screen.

*Windows® Vista*

1. Click **Start**  → **Control Panel** → **Programs** → **Use an older program with this version of Windows**.
2. In the welcome screen, click **Next**.
3. Follow the instructions on the screen.

**If you have other software problems —**

- Back up your files immediately.
- Use a virus-scanning program to check your computer.
- Save and close any open files or programs and shut down your computer through the **Start**  menu.

## Solving Problems

- Check the software documentation or contact the software manufacturer for troubleshooting information:
  - Ensure that the program is compatible with the operating system installed on your computer.
  - Ensure that your computer meets the minimum hardware requirements needed to run the software. See the software documentation for information.
  - Ensure that the program is installed and configured properly.
  - Verify that the device drivers do not conflict with the program.
  - If necessary, uninstall and then reinstall the program.
  - Write down any error message that is displayed to help in troubleshooting.

# Using Support Tools

## Dell Support Center

The **Dell Support Center** helps you find the service, support, and system-specific information you need.

To launch the application, click the  icon in the taskbar.

The **Dell Support Center** home page displays your computer's model number, service tag, express service code, and service contact information.

The home page also provides links to access:



**Self Help** (Troubleshooting, Security, System Performance, Network/Internet, Backup/Recovery, and Windows operating system)



**Alerts** (technical support alerts relevant to your computer)



**Assistance from Dell** (Technical Support with DellConnect™, Customer Service, Training and Tutorials, How-To Help with Solution Station, and Online Scan with PC CheckUp)



**About Your System** (System Documentation, Warranty Information, System Information, Upgrades & Accessories)

For more information about **Dell Support Center** and available support tools, click the **Services** tab at [support.dell.com](http://support.dell.com).

### My Dell Downloads

 **NOTE:** My Dell Downloads may not be available in all regions.

Some of the software pre-installed on your new computer do not include a backup CD or DVD. This software is available at My Dell Downloads. From this web site you can download available software for reinstallation or create your own backup media.

To register and use My Dell Downloads:

1. Go to **downloadstore.dell.com/media**.
2. Follow the instructions on the screen to register and download the software.

Reinstall or create backup media of the software for future use.

### System Messages

If your computer has an issue or error, it may display a System Message that will help you identify the cause and action needed to resolve the issue.

 **NOTE:** If the message you received is not listed in the following examples, see the documentation for either the operating system or the program that was running when the message appeared. Alternatively you could see the *Dell Technology Guide* on your computer or at **support.dell.com** or see “Contacting Dell” on page 58 for assistance.

**Alert! Previous attempts at booting this system have failed at checkpoint [nnnn]. For help in resolving this problem, please note this checkpoint and contact Dell Technical Support** — The computer failed to complete the boot routine three consecutive times for the same error (see “Contacting Dell” on page 58 for assistance).



**CMOS checksum error** — Possible system board failure or RTC battery low. Replace the battery. See the *Service Manual* at [support.dell.com](http://support.dell.com) or see “Contacting Dell” on page 58 for assistance.

**CPU fan failure** — CPU fan has failed. Replace the CPU fan. See the *Service Manual* at [support.dell.com](http://support.dell.com).

**Hard-disk (HDD) drive failure** — Possible hard disk drive failure during POST (see “Contacting Dell” on page 58 for assistance).

**Hard-disk drive read failure** — Possible hard drive failure during HDD boot test (see “Contacting Dell” on page 58 for assistance).

**Keyboard failure** — Keyboard failure or loose cable. Ensure that the keyboard cable is connected. In case of keyboard failure, replace the keyboard. For assistance, see the *Service Manual* at [support.dell.com](http://support.dell.com).

**No boot device available** — No bootable partition on hard drive, the hard drive cable is loose, or no bootable device exists.

- If the hard drive is your boot device, ensure that the cables are connected and that the drive is installed properly and partitioned as a boot device.
- Enter system setup and ensure that the boot sequence information is correct (see *Dell Technology Guide* on your computer or at [support.dell.com](http://support.dell.com)).

**No timer tick interrupt** — A chip on the system board might be malfunctioning or system board failure (see “Contacting Dell” on page 58 for assistance).

**USB over current error** — Disconnect the USB device. Your USB device needs more power for it to function properly. Use an external power source to connect the USB device, or if your device has two USB cables, connect both of them.

**NOTICE - Hard Drive SELF MONITORING SYSTEM has reported that a parameter has exceeded its normal operating range. Dell recommends that you back up your data regularly. A parameter out of range may or may not indicate a potential hard drive problem** — S.M.A.R.T error, possible hard drive failure. This feature can be enabled or disabled in the BIOS setup (see “Contacting Dell” on page 58 for assistance).

## Hardware Troubleshooter

If a device is either not detected during the operating system setup or is detected but incorrectly configured, you can use the **Hardware Troubleshooter** to resolve the incompatibility.

To start the Hardware Troubleshooter:

1. Click **Start**  → **Help and Support**.
2. Type `hardware troubleshooter` in the search field and press <Enter> to start the search.
3. In the search results, select the option that best describes the problem and follow the remaining troubleshooting steps.

## Dell Diagnostics

If you experience a problem with your computer, perform the checks in “Lockups and Software Problems” on page 34 and run the Dell Diagnostics before you contact Dell for technical assistance.

 **NOTE:** Dell Diagnostics works only on Dell computers.

 **NOTE:** The *Drivers and Utilities* disc may not ship with your computer.

Ensure that the device that you want to test displays in the system setup program and is active. Press <F2> during POST (Power On Self Test) to enter the System Setup (BIOS) utility.

Start the Dell Diagnostics from your hard drive or from the *Drivers and Utilities* disc.

## Starting Dell Diagnostics From Your Hard Drive

The Dell Diagnostics is located on a hidden diagnostic utility partition on your hard drive.

 **NOTE:** If your computer cannot display a screen image, contact Dell (see “Contacting Dell” on page 58).

1. Ensure that the computer is connected to an electrical outlet that is known to be working properly.
2. Turn on (or restart) your computer.
3. When the DELL™ logo appears, press <F12> immediately. Select **Diagnostics** from the boot menu and press <Enter>. This may invoke the Pre-Boot System Assessment (PSA) on your computer.

 **NOTE:** If you wait too long and the operating system logo appears, continue to wait until you see the Microsoft® Windows® desktop; then, shut down your computer and try again.

## Using Support Tools

 **NOTE:** If you see a message stating that no diagnostics utility partition has been found, run the Dell Diagnostics from the *Drivers and Utilities* disc.

*If PSA is invoked:*

- a. The PSA will start running tests.
- b. If the PSA completes successfully, the following message is displayed: "No problems have been found with this system so far. Do you want to run the remaining memory tests? This will take about 30 minutes or more. Do you want to continue? (Recommended)."

- c. If you are experiencing memory issues, press <y>, otherwise press <n>. The following message is displayed: "Booting Dell Diagnostic Utility Partition. Press any key to continue."
- d. Press any key to go to the **Choose An Option** window.



*If PSA is not invoked:*

Press any key to start the Dell Diagnostics from the diagnostic utility partition on your hard drive and to go to the **Choose An Option** window.

4. Select the test you want to run.

5. If you encounter a problem during a test, a message with the error code and a description of the problem will appear on your screen. Write down the error code and problem description and contact Dell (see “Contacting Dell” on page 58).
-  **NOTE:** The Service Tag for your computer is displayed at the top of each test screen. The Service Tag helps you identify your computer when you contact Dell.
6. When the tests complete, close the test screen to return to the **Choose An Option** window.
7. To exit the Dell Diagnostics and to restart the computer, click **Exit**.

### Starting Dell Diagnostics From the Drivers and Utilities Disc

-  **NOTE:** The *Drivers and Utilities* disc may not ship with your computer.
1. Insert the *Drivers and Utilities* disc.
  2. Shut down and restart the computer. When the DELL logo appears, press <F12> immediately.
-  **NOTE:** If you wait too long and the operating system logo appears, continue to wait until you see the Microsoft® Windows® desktop; then, shut down your computer and try again.
-  **NOTE:** The next steps change the boot sequence for one time only. On the next start-up, the computer boots according to the devices specified in the system setup program.

## Using Support Tools

- When the boot device list appears, highlight **CD/DVD/CD-RW** and press <Enter>.
  - Select the **Boot from CD-ROM** option from the menu that appears and press <Enter>.
  - Type 1 to start the CD menu and press <Enter> to proceed.
  - Select **Run the 32 Bit Dell Diagnostics** from the numbered list. If multiple versions are listed, select the version appropriate for your computer.
  - Select the test you want to run.
  - If you encounter a problem during a test, a message with the error code and a description of the problem will appear on your screen. Write down the error code and problem description and contact Dell (see “Contacting Dell” on page 58).
-  **NOTE:** The Service Tag for your computer is displayed at the top of each test screen. The Service Tag helps you identify your computer when you contact Dell.
- When the tests complete, close the test screen to return to the **Choose An Option** window.
  - To exit the Dell Diagnostics and restart the computer, click **Exit**.
  - Remove the *Drivers and Utilities* disc.

# Restoring Your Operating System

You can restore the operating system on your computer using any of the following options:

 **CAUTION:** Using Dell Factory Image Restore or the *Operating System* disc permanently deletes all data files on your computer. If possible, backup your data files before using these options.

Option	Use
System Restore	as the first solution
Dell DataSafe Local Backup	when System Restore does not resolve your problem
System recovery media	when operating system failure prevents the use of System Restore and DataSafe Local Backup when installing the factory image on a newly installed hard drive
Dell Factory Image Restore	to restore your computer to the operating state it was in when you received your computer
<i>Operating System</i> disc	to reinstall only the operating system on your computer

 **NOTE:** The *Operating System* disc may not ship with your computer.

### System Restore

The Windows operating systems provide a System Restore option which allows you to return your computer to an earlier operating state (without affecting data files) if changes to the hardware, software, or other system settings have left your computer in an undesirable operating state. Any changes that System Restore makes to your computer are completely reversible.

 **CAUTION:** Make regular backups of your data files. System Restore does not monitor your data files or recover them.

#### Starting System Restore

1. Click **Start** .
2. In the search box, type `System Restore` and press <Enter>.

 **NOTE:** The **User Account Control** window may appear. If you are an administrator on the computer, click **Continue**; otherwise, contact your administrator to continue the desired action.

3. Click **Next** and follow the remaining prompts on the screen.

In the event that System Restore did not resolve the issue, you may undo the last system restore.

#### Undoing the Last System Restore

 **NOTE:** Before you undo the last system restore, save and close all open files and exit any open programs. Do not alter, open, or delete any files or programs until the system restoration is complete.

1. Click **Start** .
2. In the search box, type `System Restore` and press <Enter>.
3. Click **Undo my last restoration** and click **Next**.



## Dell DataSafe Local Backup

 **CAUTION:** Using Dell DataSafe Local Backup permanently removes any programs or drivers installed after you received your computer. Prepare backup media of applications you need to install on your computer before using Dell DataSafe Local Backup. Use Dell DataSafe Local Backup only if System Restore did not resolve your operating system problem.

 **CAUTION:** Although Dell Datasafe Local Backup is designed to preserve the data files on your computer, it is recommended that you backup your data files before using Dell DataSafe Local Backup.

 **NOTE:** Dell DataSafe Local Backup may not be available in all regions.

 **NOTE:** If Dell DataSafe Local Backup is not available on your computer, use Dell Factory Image Restore (see “Dell Factory Image Restore” on page 50) to restore your operating system.

You can use Dell DataSafe Local Backup to restore your hard drive to the operating state it was in when you purchased your computer, while preserving the data files on your computer.

Dell DataSafe Local Backup allows you to:

- Backup and restore your computer to an earlier operating state
- Create system recovery media

### Dell DataSafe Local Backup Basic

To restore the factory image while preserving the data files:

1. Turn off your computer.
2. Disconnect all the devices (USB drive, printer, etc.) connected to the computer and remove any newly added internal hardware.

 **NOTE:** Do not disconnect the AC adapter.

3. Turn on your computer.

## Restoring Your Operating System

4. When the DELL™ logo appears, press <F8> several times to access the **Advanced Boot Options** window.

 **NOTE:** If you wait too long and the operating system logo appears, continue to wait until you see the Microsoft® Windows® desktop; then, shut down your computer and try again.

5. Select **Repair Your Computer**.

6. Select **Dell DataSafe Restore and Emergency Backup** from the **System Recovery Options** menu and follow the instructions on the screen.

 **NOTE:** The restoration process might take an hour or more depending on the size of the data to be restored.

 **NOTE:** For more information, see the knowledge base article 353560 at [support.dell.com](http://support.dell.com).

## Upgrading to Dell DataSafe Local Backup Professional

 **NOTE:** Dell DataSafe Local Backup Professional may be installed on your computer, if you ordered it at the time of purchase.

Dell DataSafe Local Backup Professional provides additional features that allow you to:

- Backup and restore your computer based on file types
- Backup files to a local storage device
- Schedule automated backups

To upgrade to Dell DataSafe Local Backup Professional:

1. Double-click the Dell DataSafe Local Backup icon  on the taskbar.
2. Click **UPGRADE NOW!**
3. Follow the instructions on the screen to complete the upgrade.

## System Recovery Media

 **CAUTION:** Although the system recovery media is designed to preserve the data files on your computer, it is recommended that you backup your data files before using the system recovery media.

You can use the system recovery media, created using Dell DataSafe Local Backup, to return your hard drive to the operating state it was in when you purchased the computer while preserving the data files on your computer.

Use the system recovery media in case of:

- Operating system failure that prevents the use of recovery options that are installed on your computer.
- Hard drive failure that prevents data from being recovered.

To restore the factory image of your computer using the system recovery media:

1. Insert the system recovery disc or USB key and restart the computer.
2. When the DELL™ logo appears, press <F12> immediately.

 **NOTE:** If you wait too long and the operating system logo appears, continue to wait until you see the Microsoft® Windows® desktop; then, shut down your computer and try again.

3. Select the appropriate boot device from the list and press <Enter>.
4. Follow the instructions on the screen to complete the recovery process.

### Dell Factory Image Restore

 **CAUTION:** Using Dell Factory Image Restore permanently deletes all data on the hard drive and removes any programs or drivers installed after you received your computer. If possible, back up the data before using these options. Use Dell Factory Image Restore only if System Restore did not resolve your operating system problem.

 **NOTE:** Dell Factory Image Restore may not be available in certain countries or on certain computers.

 **NOTE:** If Dell Factory Image Restore is not available on your computer, use Dell DataSafe Local Backup (see “Dell DataSafe Local Backup” on page 47) to restore your operating system.

Use Dell Factory Image Restore only as the last method to restore your operating system. This option restores your hard drive to the operating state it was in when you purchased your computer. Any programs or files added since you received your computer—including data files—are permanently deleted from the hard drive. Data files include documents, spreadsheets, e-mail messages, digital photos, music files, and so on. If possible, back up all data before using Factory Image Restore.

#### Starting Dell Factory Image Restore

1. Turn on the computer.
2. When the Dell logo appears, press <F8> several times to access the **Advanced Boot Options Window**.

 **NOTE:** If you wait too long and the operating system logo appears, continue to wait until you see the Microsoft® Windows® desktop; then, shut down your computer and try again.

### 3. Select **Repair Your Computer**.

The **System Recovery Options** window appears.

### 4. Select a keyboard layout and click **Next**.

5. To access the recovery options, log on as a local user. To access the command prompt, type `administrator` in the **User name** field, then click **OK**.

6. Click **Dell Factory Image Restore**. The **Dell Factory Image Restore** welcome screen appears.

 **NOTE:** Depending upon your configuration, you may need to select **Dell Factory Tools**, then **Dell Factory Image Restore**.

7. Click **Next**. The **Confirm Data Deletion** screen appears.

 **NOTE:** If you do not want to proceed with Factory Image Restore, click Cancel.

8. Select the check box to confirm that you want to continue reformatting the hard drive and restoring the system software to the factory condition, then click **Next**.

The restore process begins and may take five or more minutes to complete. A message appears when the operating system and factory-installed applications have been restored to factory condition.

9. Click **Finish** to reboot the system.

# Getting Help

If you experience a problem with your computer, you can complete the following steps to diagnose and troubleshoot the problem:

1. See “Solving Problems” on page 31 for information and procedures that pertain to the problem your computer is experiencing.
2. See “Dell Diagnostics” on page 41 for procedures on how to run Dell Diagnostics.
3. Fill out the “Diagnostic Checklist” on page 57.
4. Use Dell’s extensive suite of online services available at **support.dell.com** for help with installation and troubleshooting procedures. See “Online Services” on page 54 for a more extensive list of Dell Support online.
5. If the preceding steps have not resolved the problem, see “Before You Call” on page 57 and then “Contacting Dell” on page 58.

 **NOTE:** Call Dell Support from a telephone near the computer so that the support staff can assist you with any necessary procedures.

 **NOTE:** Dell’s Express Service Code system may not be available in all countries.

When prompted by Dell’s automated telephone system, enter your Express Service Code to route the call directly to the proper support personnel. If you do not have an Express Service Code, open the **Dell Accessories** folder, double-click the **Express Service Code** icon, and follow the directions.

 **NOTE:** Some of the services mentioned below are not always available in all locations outside the continental U.S. Call your local Dell representative for information on availability.

## Technical Support and Customer Service

Dell's support service is available to answer your questions about Dell hardware. Our support staff use computer-based diagnostics to provide fast, accurate answers.

To contact Dell's support service, see "Before You Call" on page 57 and then see the contact information for your region or go to **support.dell.com**.

## DellConnect™

DellConnect is a simple online access tool that allows a Dell service and support associate to access your computer through a broadband connection, diagnose your problem and repair it all under your supervision. For more information, go to **support.dell.com** and click **DellConnect**.

### Online Services

You can learn about Dell products and services on the following websites:

- **www.dell.com**
- **www.dell.com/ap** (Asian/Pacific countries only)
- **www.dell.com/jp** (Japan only)
- **www.euro.dell.com** (Europe only)
- **www.dell.com/la** (Latin American and Caribbean countries)
- **www.dell.ca** (Canada only)

You can access Dell Support through the following websites and e-mail addresses:

#### Dell Support websites

- **support.dell.com**
- **support.jp.dell.com** (Japan only)
- **support.euro.dell.com** (Europe only)

#### Dell Support e-mail addresses

- **mobile\_support@us.dell.com**
- **support@us.dell.com**
- **la-techsupport@dell.com** (Latin America and Caribbean countries only)
- **apsupport@dell.com** (Asian/Pacific countries only)

#### Dell Marketing and Sales e-mail addresses

- **apmarketing@dell.com** (Asian/Pacific countries only)
- **sales\_canada@dell.com** (Canada only)

#### Anonymous file transfer protocol (FTP)

- **ftp.dell.com**

Log in as user: *anonymous*, and use your e-mail address as your password.



## Automated Order-Status Service

To check on the status of any Dell products that you have ordered, you can go to **support.dell.com**, or you can call the automated order-status service. A recording prompts you for the information needed to locate and report on your order. For the telephone number to call your region, see “Contacting Dell” on page 58 for problems with your order.

If you have a problem with your order, such as missing parts, wrong parts, or incorrect billing, contact Dell for customer assistance. Have your invoice or packing slip handy when you call. For the telephone number to call for your region, see “Contacting Dell” on page 58.

## Product Information



If you need information about additional products available from Dell, or if you would like to place an order, visit the Dell website at **www.dell.com**. For the telephone number to call for your region or to speak to a sales specialist, see “Contacting Dell” on page 58.

### Returning Items for Repair Under Warranty or for Credit

Prepare all items being returned, whether for repair or credit, as follows:

 **NOTE:** Before you return the product to Dell, make sure to back up any data on the hard drive(s) and on any other storage device in the product. Remove any and all confidential, proprietary and personal information, as well as removable media, such as CDs and media cards. Dell is not responsible for any of your confidential, proprietary or personal information; lost or corrupted data; or damaged or lost removable media that may be included with your return.

1. Call Dell to obtain a Return Material Authorization Number, and write it clearly and prominently on the outside of the box. For the telephone number to call your region, see “Contacting Dell” on page 58.
2. Include a copy of the invoice and a letter describing the reason for the return.
3. Include a copy of the Diagnostics Checklist (see “Diagnostic Checklist” on page 57), indicating the tests that you have run and any error messages reported by the Dell Diagnostics (see “Dell Diagnostics” on page 41).
4. Include any accessories that belong with the item(s) being returned (power cables, software, guides, and so on) if the return is for credit.

5. Pack the equipment to be returned in the original (or equivalent) packing materials.
  -  **NOTE:** You are responsible for paying shipping expenses. You are also responsible for insuring any product returned, and you assume the risk of loss during shipment to Dell. Collect On Delivery (C.O.D.) packages are not accepted.
  -  **NOTE:** Returns that are missing any of the preceding requirements will be refused at Dell's receiving dock and returned to you.

## Before You Call

-  **NOTE:** Have your Express Service Code ready when you call. The code helps Dell's automated-support telephone system direct your call more efficiently. You may also be asked for your Service Tag (located on the bottom of your computer).

Remember to fill out the following Diagnostics Checklist. If possible, turn on your computer before you call Dell for assistance and call from a telephone near the computer. You may be asked to type some commands at the keyboard, relay detailed information during operations, or try other troubleshooting steps possible only at the computer itself. Ensure that the computer documentation is available.

### Diagnostic Checklist

- Name:
- Date:
- Address:
- Phone number:
- Service Tag (bar code on the back or bottom of the computer):
- Express Service Code:
- Return Material Authorization Number (if provided by Dell support technician):
- Operating system and version:
- Devices:
- Expansion cards:
- Are you connected to a network? Yes/No
- Network, version, and network adapter:
- Programs and versions:

See your operating system documentation to determine the contents of the computer's start-up files. If the computer is connected to a printer, print each file. Otherwise, record the contents of each file before calling Dell.

- Error message, beep code, or diagnostic code:
- Description of problem and troubleshooting procedures you performed:

## Contacting Dell

For customers in the United States, call 800-WWW-DELL (800-999-3355).

 **NOTE:** If you do not have an active Internet connection, you can find contact information on your purchase invoice, packing slip, bill, or Dell product catalog.

Dell provides several online and telephone-based support and service options. Availability varies by country and product, and some services may not be available in your area.

To contact Dell for sales, technical support, or customer service issues:

1. Visit **[support.dell.com/contactdell](https://support.dell.com/contactdell)**.
2. Select your country or region.
3. Select the appropriate service or support link based on your need.
4. Choose the method of contacting Dell that is convenient for you.

# Finding More Information and Resources

**If you need to:****See:**

---

reinstall your operating system

“System Recovery Media” on page 49

---

run a diagnostic program for your computer

“Dell Diagnostics” on page 41

---

reinstall system software

“My Dell Downloads” on page 38

---

find more information about the Microsoft®  
Windows® operating system and features

**support.dell.com**

---

upgrade your computer with new or additional  
memory, or a new hard drive

the *Service Manual* at  
**support.dell.com/manuals**

---

reinstall or replace a worn or defective part



**NOTE:** In some countries, opening and replacing parts of your computer may void your warranty. Check your warranty and return policies before working inside your computer.

---

### If you need to:

---

find safety best practices information for your computer

review Warranty information, Terms and Conditions (U.S. only), Safety instructions, Regulatory information, Ergonomics information, and End User License Agreement

---

find your Service tag/Express Service Code — You must use the service tag to identify your computer on **support.dell.com** or to contact technical support

---

find drivers and downloads; readme files  
access technical support and product help  
check on your order status for new purchases  
find solutions and answers to common questions  
locate information for last-minute updates about technical changes to your computer or advanced technical-reference material for technicians or experienced users

---

### See:

---

the safety and regulatory documents that shipped with your computer and also see the Regulatory Compliance Homepage at **www.dell.com/regulatory\_compliance**

---

the bottom of your computer  
the **Dell Support Center**. To launch the **Dell Support Center**, click the  icon in the taskbar



---

**support.dell.com**

---

# Basic Specifications

This section provides basic information that you may need when setting up, updating drivers for, and upgrading your computer.

 **NOTE:** Offerings may vary by region. For more information regarding the configuration of your computer, click **Start**  → **Help and Support** and select the option to view information about your computer.

## System Model

---

Studio XPS 1640/1645/1647

## Processor

---

Type

Studio XPS 1640	Intel® Core™2 Duo
Studio XPS 1645	Intel Core i7
Studio XPS 1647	Intel Core i3
	Intel Core i5
	Intel Core i7

## Processor

---

L2 cache

Studio XPS 1640	3 MB or 6 MB
-----------------	--------------

L3 cache

Studio XPS 1645	6 MB or 8 MB
Studio XPS 1647	2 MB, 3 MB, or 4 MB

External bus frequency

Studio XPS 1640	800/1066 MHz
Studio XPS 1645/1647	100 Mhz (1 GB/s)



**Computer Information**

## System chipset

Studio XPS 1640 Intel PM45

Studio XPS  
1645/1647 Intel PM55

Data bus width 64 bits

DRAM bus width dual channel (2)  
64-bit buses

Graphics bus PCI-E X16

PCI bus 32 bits

Processor address  
bus width 32 bits

## Flash EPROM

Studio XPS 1640 16 Mbit

Studio XPS  
1645/1647 32 Mbit**Memory**Connectors two internally-  
accessible SO-DIMM  
sockets

Capacities 512 MB, 1 GB, and 2 GB

## Memory type

Studio XPS  
1640/1647 1066 MHz DDR3  
SO-DIMMStudio XPS 1645 1333 MHz DDR3  
SO-DIMM

## Memory configuration possible

Studio XPS 1640 1 GB, 2 GB, 3 GB, and  
4 GBStudio XPS  
1645/1647 1 GB, 2 GB, 3 GB, 4 GB,  
and 8 GB**NOTE:** For instructions on upgrading  
your memory, see the *Service Manual* at  
[support.dell.com](http://support.dell.com).

## Basic Specifications

### Communications

---

Modem type	external V.92 56K USB Modem (Optional)
Modem controller	hardware modem
Modem interface	Universal Serial Bus (USB)
Network adapter	10/100/1000 Ethernet LAN on system board
Wireless	
Studio XPS 1640	WLAN, WWAN, Bluetooth® wireless technology, UWB
Studio XPS 1645/1647	WLAN/WiMax, WWAN, Bluetooth wireless technology

### ExpressCard

---

ExpressCard controller	
Studio XPS 1640	Intel ICH9M
Studio XPS 1645/1647	Intel PM55
ExpressCard connector	one ExpressCard slot (54 mm)
Cards supported	ExpressCard/34 (34 mm) ExpressCard/54 (54 mm) 1.5 V and 3.3 V
ExpressCard connector size	26 pins

**Video**

Video type	integrated on system board
Video controller	
Studio XPS 1640	ATI Mobility Radeon™ HD 4670
	ATI Mobility Radeon HD 565v
Studio XPS 1645/1647	ATI Mobility Radeon HD 565v
	ATI Mobility Radeon HD 5730

**Video**

Video memory	
Studio XPS 1640	
ATI Mobility Radeon™ HD 4670	512 MB/1 GB dedicated GDDR3 memory
ATI Mobility Radeon HD 565v	1GB dedicated DDR3 memory
Studio XPS 1645/1647	1 GB dedicated DDR3 memory
LCD interface	Low Voltage Differential Signaling (LVDS)
External display support	VGA, HDMI 1.3, DisplayPort

## Basic Specifications

### Audio

---

Audio type	5.1 channel Dolby Digital High Definition audio
Audio controller	IDT 92HD73C HAD codec
Stereo conversion	24-bit (analog-to-digital and digital-to-analog)
Internal interface	High Definition audio
External interface	one microphone-in connector, two stereo headphones/speakers connectors
Speaker	two 4-ohm main speaker with one 4-ohm subwoofer
Internal speaker amplifier	2 watt per channel with 3 watt subwoofer
Volume controls	program menus, media control buttons

### Ports and Connectors

---

IEEE 1394a	4-pin serial connector
Network adapter	one RJ45 10/100/1000 connector
USB	two 4-pin USB 2.0-compliant connectors
eSATA	one 4-pin eSATA/USB combo connector
Video	one 15-hole connector
HDMI	one 19-pin connector
DisplayPort	one 20-pin connector

**Display**

Type	16.0-inch WLED
	16.0-inch RGBLED
	15.6-inch FHD WLED
Dimensions (active area)	
Height	198.72 mm (7.82 inches) (16 inches WLED/RGBLED)
	193.59 mm (7.62 inches) (15.6 inches FHD WLED)
Width	353.28 mm (13.91 inches) (16 inches WLED)
	353.45 mm (13.92 inches) (16 inches RGBLED)
	344.16 mm (13.50 inches) (15.6 inches WLED)
Diagonal	406.4 mm (16.00 inches)

**Display**

Maximum resolution	1366 x 768 (WLED)
	1920 x (3) x 1080 (RGBLED)
	1920 x 1080 (FHD WLED)
Refresh rate	60 Hz
Operating angle	0° (closed) to 140°
Viewing angles	
Horizontal	±55° (WLED) minimum
	±65° (RGBLED) minimum
	±60° (FHD WLED) minimum
Vertical	±45° (WLED/RGBLED) minimum
	±50° (FHD WLED) minimum

## Basic Specifications

### Display

---

#### Luminance (with ETED)

Studio XPS 1640	300 cd/m2 (typical) 250 cd/m2 (minimum) (WLED/RGBLED)
	300 cd/m2 (typical) 270 cd/m2 (minimum) (FHD WLED)
Studio XPS 1645/1647	300 cd/m2 (typical) 250 cd/m2 (minimum) (WLED/RGBLED)
	300 cd/m2 (typical) 270 cd/m2 (minimum) (FHD WLED)

### Display

---

Pixel pitch	0.2588 mm (WLED) 0.1840 mm (RGBLED) 0.1792 mm (FHD WLED)
Controls	brightness can be controlled through keyboard shortcuts (see the <i>Dell Technology Guide</i> for more information)

### Keyboard (backlit)

---

Number of keys	86 (U.S. and Canada); 87 (Europe); 90 (Japan)
Layout	QWERTY/AZERTY/Kanji

**Camera**

Pixel	2.0 megapixel
Video resolution	
Studio XPS 1640	320 x 240 ~1600 x 1200 (640 x 480 at 30 fps)
Studio XPS 1645/1647	320 x 240 ~ 1600 x 1200 (1280 x 720 at 30 fps)
Diagonal viewing angle	66°
X/Y position resolution (graphics table mode)	240 cpi
Size	
Width	61.9 mm (2.43 inches) sensor-active area
Height	39.04 mm (1.53 inches) rectangle

**Battery**

Type	6-cell/9-cell “smart” lithium ion
Depth	52.3 mm (2.06 inches) (6/9-cell)
Height	21.95 mm (0.86 inches) (6-cell) 41.54 mm (1.63 inches) (9-cell)
Width	204.1 mm (8.03 inches) (6-cell) 292.7 mm (11.52 inches) (9-cell)
Weight	0.33 kg (0.7 lb) (6-cell) 0.48 kg (1.06 lb) (9-cell)
Voltage	11.1 VDC
Charge time (approximate)	4 hours (when the computer is turned off)

## Basic Specifications

### Battery

---

Operating time	battery operating time varies depending on operating conditions and can be significantly reduced under certain power-intensive conditions. see the <i>Dell Technology Guide</i> for more information.
Life span (approximate)	300 discharge/charge cycles
Temperature range	
Operating	0° to 35°C (32° to 95°F)
Storage	-40° to 65°C (-40° to 149°F)
Coin-cell battery	CR-2032

### AC Adapter

---

Input voltage	100–240 VAC
Input current (maximum)	1.5 A
Input frequency	50–60 Hz
Output power	65 W, 90 W, or 130 W
Output current	
65 W	3.34 A (continuous)
90 W	4.62 A (continuous)
130 W	6.70 A (continuous)
Rated output voltage	19.5 VDC



**AC Adapter**

## Dimensions

## 65 W

Height	15 mm (0.59 inches)
Width	66 mm (2.6 inches)
Depth	127 mm (5.0 inches)

## 90 W

Height	16 mm (0.62 inches)
Width	70 mm (2.75 inches)
Depth	147 mm (5.7 inches)

## 130 W

Height	76.2 mm (3.0 inches)
Width	25.4 mm (1.0 inch)
Depth	154.7 mm (6.09 inches)

**AC Adapter**

## Weight (without AC power cord)

65 W	0.26 kg (0.6 lb)
90 W	0.345 kg (0.76 lb)
130 W	0.52 kg (1.14 lb)

## Temperature range

Operating	0° to 40°C (32° to 104°F)
Storage	-40° to 70°C (-40° to 158°F)

**Physical**

Height	24.09 mm to 33.95 mm (0.94 inches to 1.33 inches)
Width	384.9 mm (15.15 inches)
Depth	254.59 mm (10.02 inches)
Weight (with 6-cell battery)	Configurable to less than 2.94 kg (6.5 lb)

## Basic Specifications

### Computer Environment

---

#### Temperature range

Operating 0° to 35°C (32° to 95°F)

Storage -40° to 65°C (-40° to 149°F)

#### Relative humidity (maximum)

Operating 10% to 90%  
(noncondensing)

Storage 5% to 95%  
(noncondensing)

#### Maximum vibration (using a random-vibration spectrum that simulates user environment)

Operating 0.66 GRMS

Storage 1.3 GRMS

### Computer Environment

---

Maximum shock (for operating — measured with Dell Diagnostics running on the hard drive and a 2-ms half-sine pulse; for non-operating — measured with hard drive in head-parked position and a 2-ms half-sine pulse)

Operating 110 G

Storage 163 G

#### Altitude (maximum)

Operating -15.2 to 3048 m  
(-50 to 10,000 ft)

Storage -15.2 to 10,668 m  
(-50 to 35,000 ft)

Airborne contaminant level G2 or lower as defined by ISA-S71.04-1985

# Appendix

## Macrovision Product Notice

This product incorporates copyright protection technology that is protected by method claims of certain U.S. patents and other intellectual property rights owned by Macrovision Corporation and other rights owners. Use of this copyright protection technology must be authorized by Macrovision Corporation, and is intended for home and other limited viewing uses only unless otherwise authorized by Macrovision Corporation. Reverse engineering or disassembly is prohibited.

# Index

## A

- AC adapter
  - size and weight **71**
- airflow, allowing **5**

## B

- Bluetooth wireless technology **14**

## C

- CDs, playing and creating **28**
- chipset **64**
- computer capabilities **28**
- computer, setting up **5**
- connect(ing)
  - to the Internet **9**
- Contacting Dell **58**
- customer service **53**

**74**

## D

- damage, avoiding **5**
- DellConnect **53**
- Dell Diagnostics **41**
- Dell Support Center **37**
- device status lights **14**
- Diagnostic Checklist **57**
- disc drive
  - supported disc sizes **26**
- discs
  - ejecting **26**
  - using **26**
- DisplayPort connector **21**
- drivers and downloads **61**
- DVDs, playing and creating **28**

**E**

- email addresses
  - for technical support **54**

**F**

- facial recognition **22**
- finding more information **60**
- FTP login, anonymous **54**

**H**

- hardware problems
  - diagnosing **40**
- Hardware Troubleshooter **40**
- help
  - getting assistance and support **52**

**I**

- Internet connection **9**
- ISP
  - Internet Service Provider **9**

**M**

- memory support **63**
- my dell downloads **38**

**N**

- network connection
  - fixing **32**

**O**

- order status **55**

**P**

- power problems, solving **33**
- power strips, using **6**
- problems, solving **31**

## Index

processor **62**

products

information and purchasing **55**

## R

resources, finding more **60**

restoring factory image **50**

## S

setup, before you begin **5**

shipping products

for return or repair **56**

software features **28**

software problems **34**

solving problems **31**

specifications **62**

support email addresses **54**

support sites

worldwide **54**

System Messages **38**

system recovery media **8**

## T

technical support **53**

## U

USB PowerShare **18**

## V

ventilation, ensuring **5**

## W

warranty returns **56**

Windows

Program Compatibility Wizard **35**

setup **8**

wired network

network cable, connecting **6**

wireless network connection **10**



Printed in China.

Printed on recycled paper.

[www.dell.com](http://www.dell.com) | [support.dell.com](http://support.dell.com)



OPF42YA00