

Dell Inspiron 15R

Owner's Manual

Computer model: Inspiron 5520/7520
Regulatory model: P25F
Regulatory type: P25F001



Notes, Cautions, and Warnings

 **NOTE:** A NOTE indicates important information that helps you make better use of your computer.

 **CAUTION:** A CAUTION indicates potential damage to hardware or loss of data if instructions are not followed.

 **WARNING:** A WARNING indicates a potential for property damage, personal injury, or death.

Information in this document is subject to change without notice.

© 2012 Dell Inc. All rights reserved.

Reproduction of these materials in any manner whatsoever without the written permission of Dell Inc. is strictly forbidden.

Trademarks used in this text: Dell™, the DELL logo, and Inspiron™ are trademarks of Dell Inc.; Microsoft®, Windows®, and the Windows start button logo  are either trademarks or registered trademarks of Microsoft corporation in the United States and/or other countries; Bluetooth® is a registered trademark owned by Bluetooth SIG, Inc. and is used by Dell under license.

Other trademarks and trade names may be used in this document to refer to either the entities claiming the marks and names or their products. Dell Inc. disclaims any proprietary interest in trademarks and trade names other than its own.

Contents

1	Before You Begin	7
	Turn Off Your Computer and Connected Devices . . .	7
	Safety Instructions	7
	Recommended Tools	8
2	After Working Inside Your Computer	9
3	Switch	11
	Removing the Switch	11
	Replacing the Switch	12
4	Battery	13
	Removing the Battery	13
	Replacing the Battery	13
5	Keyboard	15
	Removing the Keyboard	15
	Replacing the Keyboard	16
6	Base Cover	17
	Removing the Base Cover	17
	Replacing the Base Cover	18
7	Memory Module(s)	19
	Removing the Memory Module(s)	19
	Replacing the Memory Module(s)	20
8	Hard Drive	21
	Removing the Hard Drive	21
	Replacing the Hard Drive	23
9	Optical Drive	25
	Removing the Optical Drive	25
	Replacing the Optical Drive	26

10 Palm Rest	27
Removing the Palm Rest.	27
Replacing the Palm Rest	31
11 Power-Adapter Port	33
Removing the Power-Adapter Port	33
Replacing the Power-Adapter Port	34
12 Display Assembly	35
Removing the Display Assembly.	35
Replacing the Display Assembly	37
Removing the Display Bezel	37
Replacing the Display Bezel.	38
Removing the Hinge Caps.	39
Replacing the Hinge Caps.	40
Removing the Display Panel	40
Replacing the Display Panel.	43
13 Camera Module	45
Removing the Camera Module.	45
Replacing the Camera Module.	48
14 System Board	49
Removing the System Board	49
Replacing the System Board	52
Entering the Service Tag in the BIOS	53
15 Thermal-Cooling Assembly	55
Removing the Thermal-Cooling Assembly.	55
Replacing the Thermal-Cooling Assembly	57
16 Processor	59
Removing the Processor.	59
Replacing the Processor	61
17 Coin-Cell Battery	63
Removing the Coin-Cell Battery.	63
Replacing the Coin-Cell Battery.	65

18 Speakers	67
Removing the Speakers	67
Replacing the Speakers.	69
19 Media Card Reader	71
Removing the Media Card Reader	71
Replacing the Media Card Reader.	73
20 Daughter Board	75
Removing the Daughter Board.	75
Replacing the Daughter Board.	77
21 Mini-Card	79
Removing the Mini-Card.	79
Replacing the Mini-Card.	80
22 Flashing the BIOS	83

1

Before You Begin

Turn Off Your Computer and Connected Devices

 **CAUTION:** To avoid losing data, save and close all open files and exit all open programs before you turn off your computer.

- 1 Save and close all open files and exit all open programs.
- 2 Click **Start**  and click **Shut down**.

Microsoft Windows shuts down and then the computer turns off.

 **NOTE:** If you are using a different operating system, see the documentation of your operating system for shut-down instructions.

- 3 Disconnect your computer and all attached devices from their electrical outlets.
- 4 Disconnect all telephone cables, network cables, and attached devices from your computer.
- 5 Press and hold the power button for about 5 seconds, after the computer is unplugged, to ground the system board.

Safety Instructions

Use the following safety guidelines to protect your computer from potential damage and ensure your personal safety.

 **WARNING:** Before working inside your computer, read the safety information that shipped with your computer. For additional safety best practices information, see the Regulatory Compliance Homepage at dell.com/regulatory_compliance.

 **WARNING:** Disconnect all power sources before opening the computer cover or panels. After you finish working inside the computer, replace all covers, panels, and screws before connecting to the power source.

 **CAUTION:** To avoid damaging the computer, ensure that the work surface is flat and clean.

 **CAUTION:** To avoid damaging the components and cards, handle them by their edges and avoid touching pins and contacts.

 **CAUTION:** Only a certified service technician is authorized to remove the computer cover and access any of the components inside the computer. See the safety instructions for complete information about safety precautions, working inside your computer, and protecting against electrostatic discharge.

 **CAUTION:** Before touching anything inside your computer, ground yourself by touching an unpainted metal surface, such as the metal at the back of the computer. While you work, periodically touch an unpainted metal surface to dissipate static electricity, which could harm internal components.

 **CAUTION:** When you disconnect a cable, pull on its connector or on its pull-tab, not on the cable itself. Some cables have connectors with locking tabs or thumb-screws that you must disengage before disconnecting the cable. When disconnecting cables, keep them evenly aligned to avoid bending any connector pins. When connecting cables, ensure that the connectors and ports are correctly oriented and aligned.

 **CAUTION:** To disconnect a network cable, first unplug the cable from your computer and then unplug the cable from the network device.

Recommended Tools

The procedures in this document may require the following tools:

- Phillips screwdriver
- Plastic scribe
- Small flat-blade screwdriver

2

After Working Inside Your Computer

After you complete replacement procedures, ensure the following:

- Replace all screws and ensure that no stray screws remain inside your computer
- Connect any external devices, cables, cards, and any other part(s) you removed before working on your computer
- Connect your computer and all attached devices to their electrical outlets



CAUTION: Before turning on your computer, replace all screws and ensure that no stray screws remain inside the computer. Failure to do so may damage your computer.

3

Switch

⚠ WARNING: Before working inside your computer, read the safety information that shipped with your computer and follow the steps in "Before You Begin" on page 7. For additional safety best practices information, see the Regulatory Compliance Homepage at dell.com/regulatory_compliance.

Removing the Switch

- 1 Slide the switch release latch to the side.
The switch pops up.
- 2 Lift the switch off the computer.



1	display cover	2	switch release latch
3	switch		

Replacing the Switch

Procedure

- 1 Align the tabs at the bottom of the switch with the slots on the display cover and snap the switch into place.

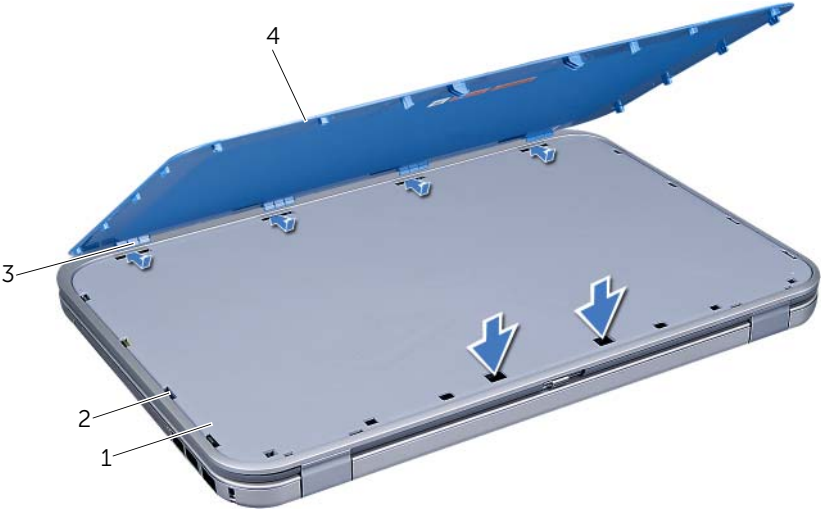

1	display cover	2	slots
3	tabs	4	switch

- 2 Follow the instructions in "After Working Inside Your Computer" on page 9.

4

Battery

⚠ WARNING: Before working inside your computer, read the safety information that shipped with your computer and follow the steps in "Before You Begin" on page 7. For additional safety best practices information, see the Regulatory Compliance Homepage at dell.com/regulatory_compliance.

Removing the Battery

- 1 Close the display and turn the computer over.
- 2 Slide the battery release latches to the unlock position.
- 3 Lift the battery out of the battery bay.



1 battery release latches (2) 2 battery

Replacing the Battery

- 1 Align the tabs on the battery with the slots on the battery bay and snap the battery until it clicks into place.
- 2 Follow the instructions in "After Working Inside Your Computer" on page 9.

5

Keyboard

⚠ WARNING: Before working inside your computer, read the safety information that shipped with your computer and follow the steps in "Before You Begin" on page 7. For additional safety best practices information, see the Regulatory Compliance Homepage at dell.com/regulatory_compliance.

Removing the Keyboard

Prerequisites

- 1 Remove the battery. See "Removing the Battery" on page 13.

Procedure

⚠ CAUTION: The keycaps on the keyboard are fragile, easily dislodged, and time-consuming to replace. Be careful when removing and handling the keyboard.

- 1 Turn the computer over and open the display as far as possible.
- 2 Using a plastic scribe, release the keyboard from the tabs on the palm rest and ease the keyboard up until it clears off the palm rest.

⚠ CAUTION: Be extremely careful when removing and handling the keyboard. Failure to do so could result in scratching the display panel.



1 tabs (4)	2 plastic scribe
3 keyboard	4 palm rest

- 3 Carefully turn the keyboard over and place it on the palm rest.
- 4 Lift the connector latch and pull the pull-tab to disconnect the keyboard cable from the connector on the system board.
- 5 Lift the keyboard away from the computer.



-
- | | |
|------------------|-------------------|
| 1 keyboard cable | 2 connector latch |
|------------------|-------------------|
-
- | |
|------------|
| 3 tabs (5) |
|------------|
-

Replacing the Keyboard

Procedure

- 1 Slide the keyboard cable into the connector on the system board and press down on the connector latch to secure the cable.
- 2 Slide the tabs at the bottom of the keyboard into the slots on the palm rest and place the keyboard on the palm rest.
- 3 Gently press around the edges of the keyboard to secure the keyboard under the tabs on the palm rest.
- 4 Close the display and turn the computer over.

Postrequisites

- 1 Replace the battery. See "Replacing the Battery" on page 13.
- 2 Follow the instructions in "After Working Inside Your Computer" on page 9.

6

Base Cover

⚠ WARNING: Before working inside your computer, read the safety information that shipped with your computer and follow the steps in "Before You Begin" on page 7. For additional safety best practices information, see the Regulatory Compliance Homepage at dell.com/regulatory_compliance.

Removing the Base Cover

Prerequisites

- 1 Remove the battery. See "Removing the Battery" on page 13.

Procedure

- 1 Loosen the captive screws that secure the base cover to the computer base.
- 2 Using your fingertips, pry the base cover from the computer base.
- 3 Lift the base cover off the computer base.



1	base cover	2	captive screws (3)
---	------------	---	--------------------

Replacing the Base Cover

Procedure

- 1 Slide the tabs on the base cover into the slots on the computer base and snap the base cover into place.
- 2 Tighten the captive screws that secure the base cover to the computer base.

Postrequisites

- 1 Replace the battery. See "Replacing the Battery" on page 13.
- 2 Follow the instructions in "After Working Inside Your Computer" on page 9.

7

Memory Module(s)

⚠ WARNING: Before working inside your computer, read the safety information that shipped with your computer and follow the steps in "Before You Begin" on page 7. For additional safety best practices information, see the Regulatory Compliance Homepage at dell.com/regulatory_compliance.

Removing the Memory Module(s)

Prerequisites

- 1 Remove the battery. See "Removing the Battery" on page 13.
- 2 Remove the base cover. See "Removing the Base Cover" on page 17.

Procedure

⚠ CAUTION: To prevent damage to the memory-module connector, do not use tools to spread the memory-module securing clips.

- 1 Use your fingertips to carefully spread apart the securing clips on each end of the memory-module connector until the memory module pops up.
- 2 Remove the memory module from the memory-module connector.

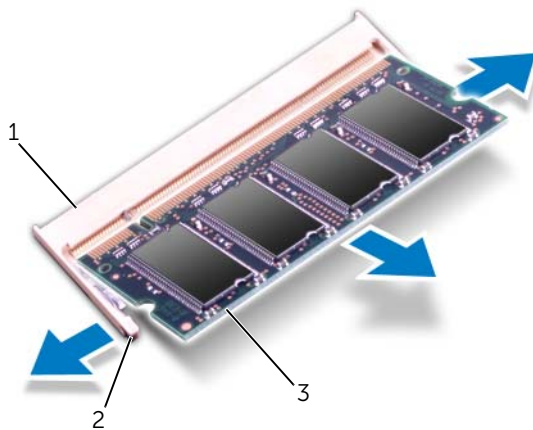

1	memory-module connector	2	securing clips (2)
3	memory module		

Replacing the Memory Module(s)

Procedure

- 1 Align the notch on the memory module with the tab on the memory-module connector.
- 2 Slide the memory module firmly into the slot at a 45-degree angle, and press the memory module down until it clicks into place. If you do not hear the click, remove the memory module and reinstall it.



NOTE: If the memory module is not installed properly, the computer may not boot.

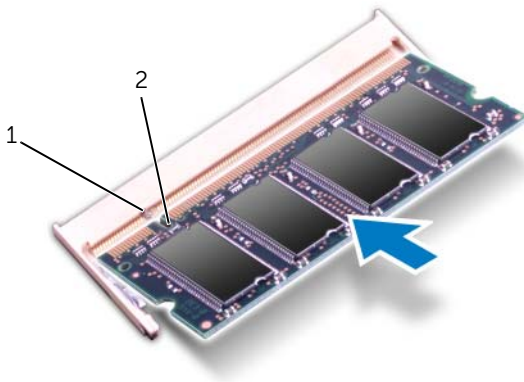

1 tab

2 notch

Postrequisites

- 1 Replace the base cover. See "Replacing the Base Cover" on page 18.
- 2 Replace the battery. See "Replacing the Battery" on page 13.
- 3 Follow the instructions in "After Working Inside Your Computer" on page 9.
- 4 Turn on the computer.



As the computer boots, it detects the memory module(s) and automatically updates the system configuration information.

To confirm the amount of memory installed in the computer:

Click **Start**  → **Control Panel** → **System and Security** → **System**.

8

Hard Drive

-  **WARNING:** Before working inside your computer, read the safety information that shipped with your computer and follow the steps in "Before You Begin" on page 7. For additional safety best practices information, see the Regulatory Compliance Homepage at dell.com/regulatory_compliance.
-  **CAUTION:** To avoid data loss, do not remove the hard drive while the computer is On or in Sleep state.
-  **CAUTION:** Hard drives are extremely fragile. Exercise care when handling the hard drive.

Removing the Hard Drive

Prerequisites

- 1 Remove the battery. See "Removing the Battery" on page 13.
- 2 Remove the base cover. See "Removing the Base Cover" on page 17.

Procedure

- 1 Remove the screws that secure the hard-drive assembly to the computer base.
- 2 Using the pull-tab, slide the hard-drive assembly toward the back of the computer to disconnect the hard-drive assembly from the connector on the system board.
- 3 Lift the hard-drive assembly out of the computer base.

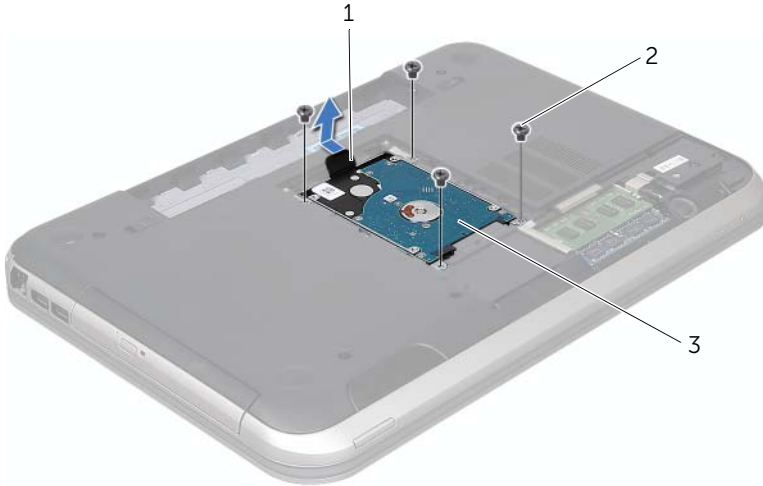

1 pull-tab

2 screws (4)

3 hard-drive assembly

- 4 Remove the screws that secure the hard-drive bracket to the hard drive.
- 5 Lift the hard drive off the hard-drive bracket.

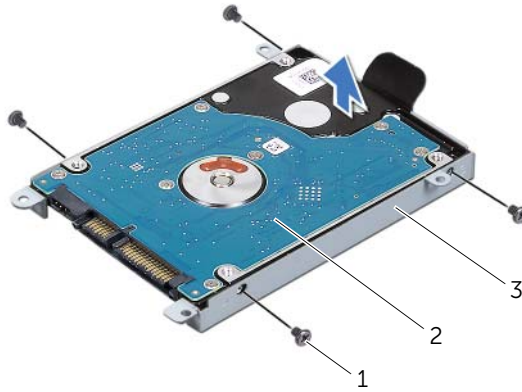

1	screws (4)	2	hard drive
3	hard-drive bracket		

Replacing the Hard Drive

Procedure

- 1 Remove the new hard drive from its packaging.
Save the original packaging for storing or shipping the hard drive.
- 2 Align the screw holes on the hard drive-bracket with the screw holes on the hard drive.
- 3 Replace the screws that secure the hard-drive bracket to the hard drive.
- 4 Place the hard-drive assembly on the computer base.
- 5 Using the pull-tab, slide the hard-drive assembly toward the front of the computer, to connect the hard-drive assembly to the connector on the system board.
- 6 Replace the screws that secure the hard-drive assembly to the computer base.

Postrequisites

- 1 Replace the base cover. See "Replacing the Base Cover" on page 18.
- 2 Replace the battery. See "Replacing the Battery" on page 13.
- 3 Follow the instructions in "After Working Inside Your Computer" on page 9.

9

Optical Drive

⚠ WARNING: Before working inside your computer, read the safety information that shipped with your computer and follow the steps in "Before You Begin" on page 7. For additional safety best practices information, see the Regulatory Compliance Homepage at dell.com/regulatory_compliance.

Removing the Optical Drive

Prerequisites

- 1 Remove the battery. See "Removing the Battery" on page 13.
- 2 Remove the base cover. See "Removing the Base Cover" on page 17.

Procedure

- 1 Remove the screw that secures the optical-drive assembly to the computer base.
- 2 Using your fingertips, slide the optical-drive assembly out of the optical-drive bay.



-
- | | | | |
|---|------------------------|---|-------|
| 1 | optical-drive assembly | 2 | screw |
|---|------------------------|---|-------|
-

- 3 Carefully pry the optical-drive bezel and remove it from the optical-drive assembly.
- 4 Remove the screws that secure the optical-drive bracket to the optical drive.
- 5 Remove the optical-drive bracket.

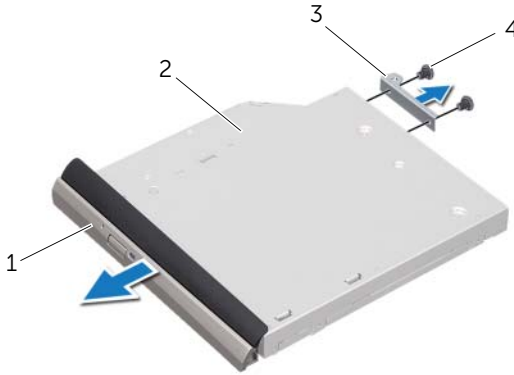

1	optical-drive bezel	2	optical drive
3	optical-drive bracket	4	screws (2)

Replacing the Optical Drive

Procedure

- 1 Align the screw holes on the optical-drive bracket with the screw holes on the optical drive.
- 2 Replace the screws that secure the optical-drive bracket to the optical drive.
- 3 Align the tabs on the optical-drive bezel with the slots on the optical-drive assembly and snap the optical-drive bezel into place.
- 4 Slide the optical-drive assembly into the optical-drive bay until it is fully seated.
- 5 Replace the screw that secures the optical-drive assembly to the computer base.

Postrequisites

- 1 Replace the base cover. See "Replacing the Base Cover" on page 18.
- 2 Replace the battery. See "Replacing the Battery" on page 13.
- 3 Follow the instructions in "After Working Inside Your Computer" on page 9.

10

Palm Rest

⚠ WARNING: Before working inside your computer, read the safety information that shipped with your computer and follow the steps in "Before You Begin" on page 7. For additional safety best practices information, see the Regulatory Compliance Homepage at dell.com/regulatory_compliance.

Removing the Palm Rest

Prerequisites

- 1 Remove the battery. See "Removing the Battery" on page 13.
- 2 Remove the keyboard. See "Removing the Keyboard" on page 15.
- 3 Remove the base cover. See "Removing the Base Cover" on page 17.

Procedure

- 1 Remove the screws that secure the palm rest to the computer base.



- 2 Turn the computer over.
- 3 Lift the connector latches and pull the pull-tabs to disconnect the power-button board cable, touchpad cable, and hot-key board cable from the connectors on the system board.

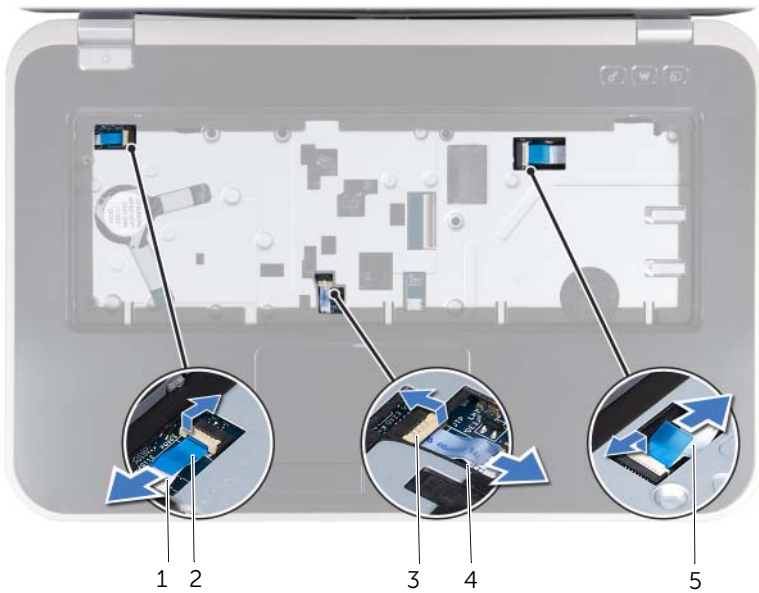

1	power-button board cable	2	pull-tab
3	connector latch	4	touchpad cable
5	hot-key board cable		

4 Remove the screws that secure the palm rest to the computer base.

5 Using your fingertips, pry out the palm rest from the computer base.

CAUTION: Carefully separate the palm rest from the display assembly to avoid damage to the display assembly.



1 screws (6)

2 palm rest

- 6 Without pulling hard on the palm-rest assembly, place it away from the display as shown in the illustration below.
- 7 Lift the connector latch and pull the pull-tab to disconnect the status-lights cable from the connector on the system board.
- 8 Lift the palm-rest assembly off the computer base.



1 connector latch

2 pull-tab

3 status-lights cable

Replacing the Palm Rest

Procedure

- 1 Slide the status-lights cable into the connector on the system board and press down on the connector latch to secure the cable.
- 2 Align the palm rest with the computer base and gently snap the palm rest into place.
- 3 Slide the hot-key board cable, power-button board cable, and touchpad cable into the connectors on the system board and press down on the connector latches to secure the cables.
- 4 Replace the screws that secure the palm rest to the computer base.
- 5 Turn the computer over and replace the screws that secure the palm rest to the computer base.

Postrequisites

- 1 Replace the base cover. See "Replacing the Base Cover" on page 18.
- 2 Replace the keyboard. See "Replacing the Keyboard" on page 16.
- 3 Replace the battery. See "Replacing the Battery" on page 13.
- 4 Follow the instructions in "After Working Inside Your Computer" on page 9.

11

Power-Adapter Port

⚠ WARNING: Before working inside your computer, read the safety information that shipped with your computer and follow the steps in "Before You Begin" on page 7. For additional safety best practices information, see the Regulatory Compliance Homepage at dell.com/regulatory_compliance.

Removing the Power-Adapter Port

Prerequisites

- 1 Remove the battery. See "Removing the Battery" on page 13.
- 2 Remove the keyboard. See "Removing the Keyboard" on page 15.
- 3 Remove the base cover. See "Removing the Base Cover" on page 17.
- 4 Remove the palm rest. See "Removing the Palm Rest" on page 27.

Procedure

- 1 Remove the screws that secure the power-adapter port bracket to the computer base.
- 2 Lift the power-adapter port bracket off the computer base.



1 screws (2)

2 power-adapter port bracket

- 3 Disconnect the power-adapter port cable from the connector on the system board.
- 4 Lift the power-adapter port off the computer base.

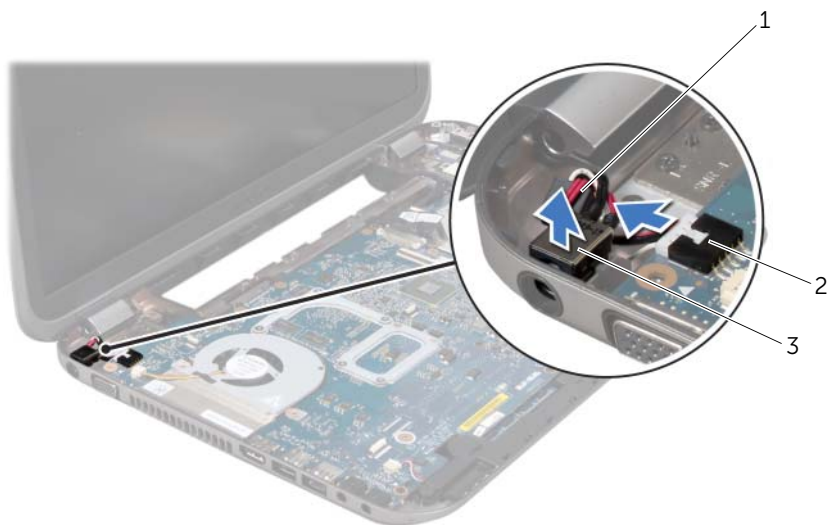

-
- | | |
|----------------------------|--------------------------|
| 1 power-adapter port cable | 2 system-board connector |
| 3 power-adapter port | |
-

Replacing the Power-Adapter Port

Procedure

- 1 Place the power-adapter port in the slot on the computer base.
- 2 Connect the power-adapter port cable to the connector on the system board.
- 3 Align the screw holes on the power-adapter port bracket with the screw holes on the computer base.
- 4 Replace the screws that secure the power-adapter port bracket to the computer base.

Postrequisites

- 1 Replace the palm rest. See "Replacing the Palm Rest" on page 31.
- 2 Replace the base cover. See "Replacing the Base Cover" on page 18.
- 3 Replace the keyboard. See "Replacing the Keyboard" on page 16.
- 4 Replace the battery. See "Replacing the Battery" on page 13.
- 5 Follow the instructions in "After Working Inside Your Computer" on page 9.



WARNING: Before working inside your computer, read the safety information that shipped with your computer and follow the steps in "Before You Begin" on page 7. For additional safety best practices information, see the Regulatory Compliance Homepage at dell.com/regulatory_compliance.

Removing the Display Assembly

Prerequisites

- 1 Remove the battery. See "Removing the Battery" on page 13.
- 2 Remove the keyboard. See "Removing the Keyboard" on page 15.
- 3 Remove the base cover. See "Removing the Base Cover" on page 17.
- 4 Remove the palm rest. See "Removing the Palm Rest" on page 27.

Procedure

- 1 Disconnect the antenna cables from the connectors on the Mini-Card.
- 2 Peel the tape that secures the display cable to the system board and then disconnect the display cable from the connector on the system board.
- 3 Make a note of the display cable routing and remove the cable from the routing guides.
- 4 Remove the screws that secure the display assembly to the computer base.
- 5 Lift the display assembly off the computer base.



1 display assembly	2 screws (6)
3 tape	4 display cable
5 antenna cables (2)	

Replacing the Display Assembly

Procedure

- 1 Place the display assembly in position and replace the screws that secure the display assembly to the computer base.
- 2 Route the display cable through the routing guides and connect the display cable to the connector on the system board.
- 3 Adhere the tape that secures the display cable to the system board.
- 4 Connect the antenna cables to the connectors on the Mini-Card.

Postrequisites

- 1 Replace the palm rest. See "Replacing the Palm Rest" on page 31.
- 2 Replace the base cover. See "Replacing the Base Cover" on page 18.
- 3 Replace the keyboard. See "Replacing the Keyboard" on page 16.
- 4 Replace the battery. See "Replacing the Battery" on page 13.
- 5 Follow the instructions in "After Working Inside Your Computer" on page 9.

Removing the Display Bezel

Prerequisites

- 1 Remove the battery. See "Removing the Battery" on page 13.
- 2 Remove the keyboard. See "Removing the Keyboard" on page 15.
- 3 Remove the base cover. See "Removing the Base Cover" on page 17.
- 4 Remove the palm rest. See "Removing the Palm Rest" on page 27.
- 5 Remove the display assembly. See "Removing the Display Assembly" on page 35.

Procedure

△ CAUTION: The display bezel is extremely fragile. Be careful when removing it to prevent damaging the display bezel.

- 1 Using your fingertips, carefully pry up the inside edge of the display bezel.
- 2 Remove the display bezel.



1 display bezel

Replacing the Display Bezel

Procedure

Align the display bezel with the display cover and gently snap the display bezel into place.

Postrequisites

- 1 Replace the display assembly. See "Replacing the Display Assembly" on page 37.
- 2 Replace the palm rest. See "Replacing the Palm Rest" on page 31.
- 3 Replace the base cover. See "Replacing the Base Cover" on page 18.
- 4 Replace the keyboard. See "Replacing the Keyboard" on page 16.
- 5 Replace the battery. See "Replacing the Battery" on page 13.
- 6 Follow the instructions in "After Working Inside Your Computer" on page 9.

Removing the Hinge Caps

Prerequisites

- 1 Remove the battery. See "Removing the Battery" on page 13.
- 2 Remove the keyboard. See "Removing the Keyboard" on page 15.
- 3 Remove the base cover. See "Removing the Base Cover" on page 17.
- 4 Remove the palm rest. See "Removing the Palm Rest" on page 27.
- 5 Remove the display assembly. See "Removing the Display Assembly" on page 35.
- 6 Remove the display bezel. See "Removing the Display Bezel" on page 37.

Procedure

- 1 Remove the screws that secure the hinge caps to the display cover.
- 2 Lift the hinge cap, and slide the antenna cables through the slot on the hinge cap.



1 hinge caps (2)	2 screws (4)
3 display cover	

Replacing the Hinge Caps

Procedure

- 1 Slide the antenna cables through the slot on the hinge cover
- 2 Align the screw holes on the hinge caps with the screw holes on the display cover.
- 3 Replace the screws that secure the hinge caps to the display cover.

Postrequisites

- 1 Replace the display bezel. See "Replacing the Display Bezel" on page 38.
- 2 Replace the display assembly. See "Replacing the Display Assembly" on page 37.
- 3 Replace the palm rest. See "Replacing the Palm Rest" on page 31.
- 4 Replace the base cover. See "Replacing the Base Cover" on page 18.
- 5 Replace the keyboard. See "Replacing the Keyboard" on page 16.
- 6 Replace the battery. See "Replacing the Battery" on page 13.

Removing the Display Panel

Prerequisites

- 1 Remove the battery. See "Removing the Battery" on page 13.
- 2 Remove the keyboard. See "Removing the Keyboard" on page 15.
- 3 Remove the base cover. See "Removing the Base Cover" on page 17.
- 4 Remove the palm rest. See "Removing the Palm Rest" on page 27.
- 5 Remove the display assembly. See "Removing the Display Assembly" on page 35.
- 6 Remove the display bezel. See "Removing the Display Bezel" on page 37.
- 7 Remove the hinge caps. See "Removing the Hinge Caps" on page 39.

Procedure

- 1 Remove the screws that secure the display panel to the display cover.
- 2 Carefully lift the display panel and turn it over.

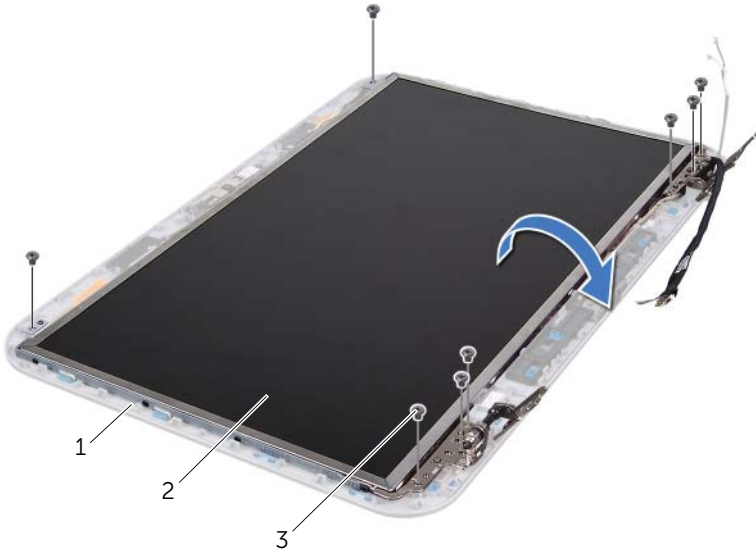

1 display cover

2 display panel

3 screws (8)

- 3 Peel and lift the tape that secures the display cable to the display-board connector and disconnect the display cable.
- 4 Peel the display cable from the back of the display panel.

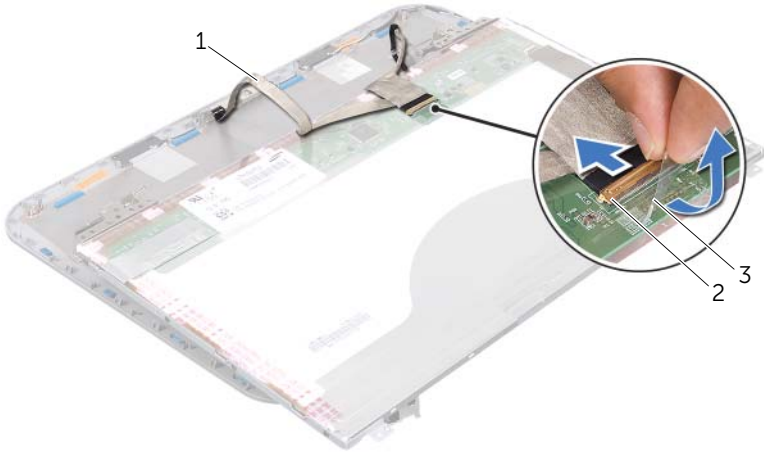

1 display cable	2 display-board connector
3 tape	

- 5 Turn the display panel over and place it on a clean surface.
- 6 Remove the screws that secure the display-panel brackets to the display panel.
- 7 Remove the display-panel brackets off the display panel.

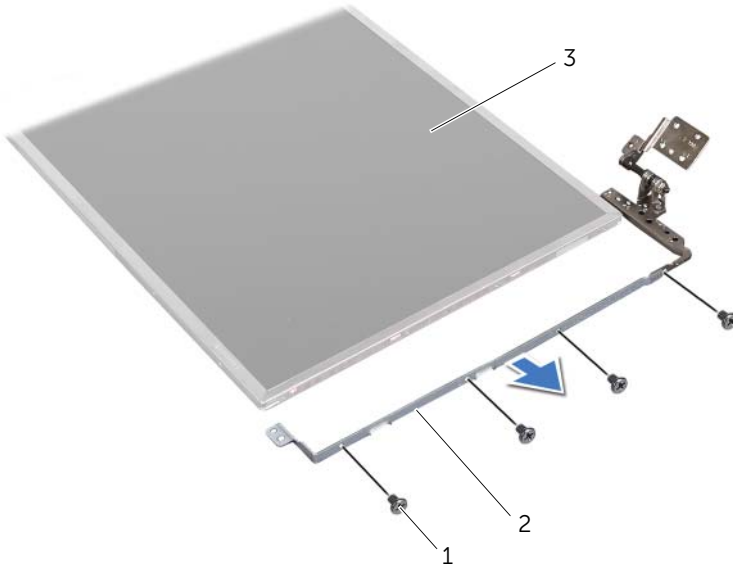

1 screws (8)	2 display-panel brackets (2)
3 display panel	

Replacing the Display Panel

Procedure

- 1 Align the screw holes on the display-panel bracket with the screw holes on the display panel and replace the screws that secure the display-panel bracket to the display panel.
- 2 Turn the display panel over.
- 3 Adhere the display cable to the back of the display panel.
- 4 Connect the display cable to the display-board connector and secure it with the tape.
- 5 Align the screw holes on the display panel with the screw holes on the display cover and replace the screws that secure the display panel to the display cover.

Postrequisites

- 1 Replace the hinge caps. See "Replacing the Hinge Caps" on page 40.
- 2 Replace the display bezel. See "Replacing the Display Bezel" on page 38.
- 3 Replace the display assembly. See "Replacing the Display Assembly" on page 37.
- 4 Replace the palm rest. See "Replacing the Palm Rest" on page 31.
- 5 Replace the base cover. See "Replacing the Base Cover" on page 18.
- 6 Replace the keyboard. See "Replacing the Keyboard" on page 16.
- 7 Replace the battery. See "Replacing the Battery" on page 13.
- 8 Follow the instructions in "After Working Inside Your Computer" on page 9.



WARNING: Before working inside your computer, read the safety information that shipped with your computer and follow the steps in "Before You Begin" on page 7. For additional safety best practices information, see the Regulatory Compliance Homepage at dell.com/regulatory_compliance.

Removing the Camera Module

Prerequisites

- 1 Remove the battery. See "Removing the Battery" on page 13.
- 2 Remove the keyboard. See "Removing the Keyboard" on page 15.
- 3 Remove the base cover. See "Removing the Base Cover" on page 17.
- 4 Remove the palm rest. See "Removing the Palm Rest" on page 27.
- 5 Remove the display assembly. See "Removing the Display Assembly" on page 35.
- 6 Remove the display bezel. See "Removing the Display Bezel" on page 37.

Procedure

- 1 Remove the screws that secure the display panel to the display cover.
- 2 Carefully lift the display panel and turn it over.

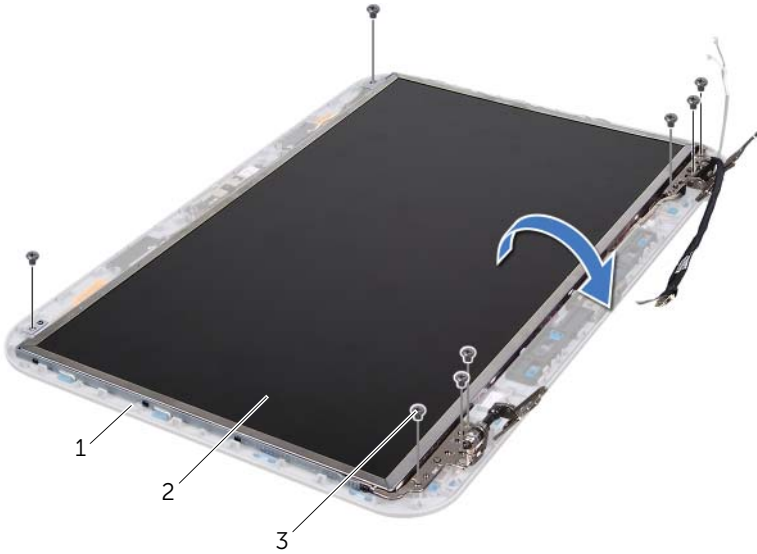

1 display cover

2 display panel

3 screws (8)

3 Disconnect the camera cable from the connector on the camera module.

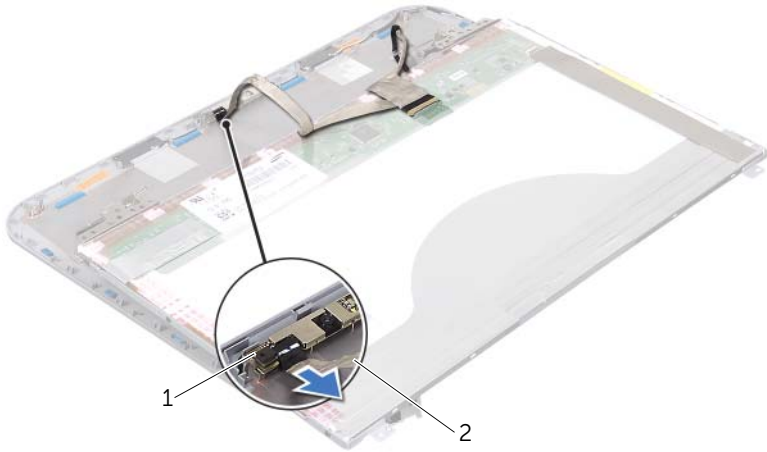

1 camera module	2 camera cable
-----------------	----------------

4 Remove the screw that secures the camera module to the display cover.

5 Lift the camera module off the display cover.

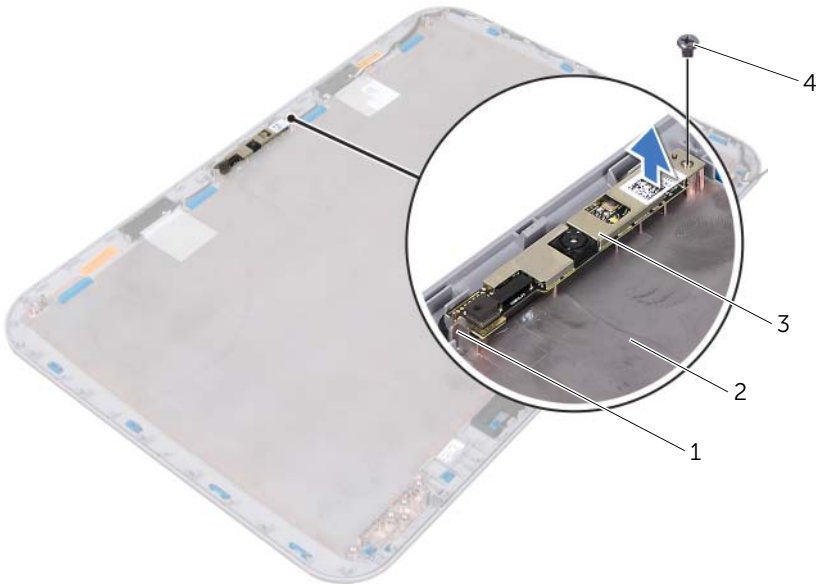

1 tab	2 display cover
3 camera module	4 screw

Replacing the Camera Module

Procedure

- 1 Use the alignment posts on the display cover to place the camera module in position.
Ensure that the camera module is secured under the tab on the display cover.
- 2 Connect the camera cable to the connector on the camera module.
- 3 Replace the screw that secures the camera module to the display cover.
- 4 Turn the display panel over and place it on the display cover.
- 5 Align the screw holes on the display panel with the screw holes on the display cover.
- 6 Replace the screws that secure the display panel to the display cover.

Postrequisites

- 1 Replace the display bezel. See "Replacing the Display Bezel" on page 38.
- 2 Replace the display assembly. See "Replacing the Display Assembly" on page 37.
- 3 Replace the palm rest. See "Replacing the Palm Rest" on page 31.
- 4 Replace the base cover. See "Replacing the Base Cover" on page 18.
- 5 Replace the keyboard. See "Replacing the Keyboard" on page 16.
- 6 Replace the battery. See "Replacing the Battery" on page 13.
- 7 Follow the instructions in "After Working Inside Your Computer" on page 9.



WARNING: Before working inside your computer, read the safety information that shipped with your computer and follow the steps in "Before You Begin" on page 7. For additional safety best practices information, see the Regulatory Compliance Homepage at dell.com/regulatory_compliance.

Removing the System Board

Prerequisites

- 1 Remove the battery. See "Removing the Battery" on page 13.
- 2 Remove the base cover. See "Removing the Base Cover" on page 17.
- 3 Remove the memory module(s). See "Removing the Memory Module(s)" on page 19.
- 4 Follow the instructions from step 1 to step 3 in "Removing the Hard Drive" on page 21.
- 5 Follow the instructions from step 1 to step 2 in "Removing the Optical Drive" on page 25.
- 6 Remove the keyboard. See "Removing the Keyboard" on page 15.
- 7 Remove the palm rest. See "Removing the Palm Rest" on page 27.

Procedure

 **NOTE:** Your computer's Service Tag is stored in the system board. You must enter the Service Tag in the BIOS after you replace the system-board assembly.

 **NOTE:** Before disconnecting the cables from the system board, note the location of the connectors so that you can reconnect them correctly after you replace the system-board assembly.

- 1 Remove the screws that secure the power-adapter port bracket to the computer base.
- 2 Lift the power-adapter port bracket off the computer base.



1 screws (2)

2 power-adapter port bracket

- 3 Disconnect the power-adaptor port cable, fan cable, and speakers cable from the connectors on the system board.
- 4 Peel the tape that secures the display cable to the system board and then disconnect the display cable from the connector on the system board.
- 5 Lift the connector latch and pull the pull-tab to disconnect the Media Card Reader cable from the connector on the system board.

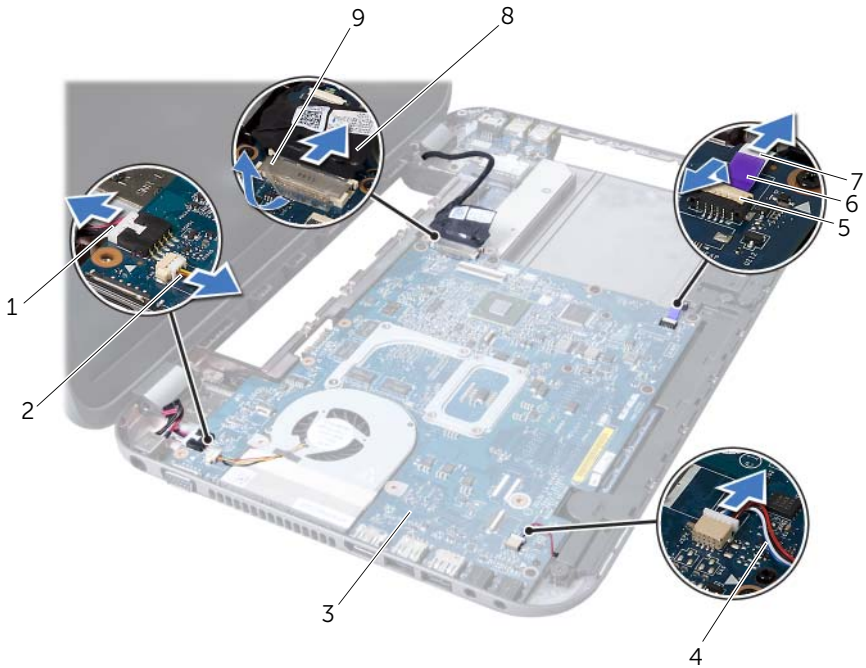

1 power-adaptor port cable	2 fan cable
3 system-board assembly	4 speakers cable
5 connector latch	6 pull-tab
7 Media Card Reader cable	8 display cable
9 tape	

- 6 Remove the screws that secure the system board to the computer base.
- 7 Lift the system board to disconnect the connector on the system board from the connector on the daughter board.
- 8 Lift the system board at an angle and release the connectors on the system board from the slots on the computer base.



1 system-board assembly	2 screws (6)
-------------------------	--------------

- 9 Remove the thermal-cooling assembly. See "Removing the Thermal-Cooling Assembly" on page 55.
- 10 Remove the processor. See "Removing the Processor" on page 59.

Replacing the System Board

Procedure

- 1 Replace the processor. See "Replacing the Processor" on page 61.
- 2 Replace the thermal-cooling assembly. See "Replacing the Thermal-Cooling Assembly" on page 57.
- 3 Slide the connectors on the system board into the slots on the computer base.
- 4 Gently press the system board to connect the connector on the system board to the connector on the daughter board.
- 5 Replace the screws that secure the system board to the computer base.

- 6 Slide the Media Card Reader cable into the connector on the system board and press down on the connector latch to secure the cable.
- 7 Connect the display cable to the connector on the system board and adhere the tape that secures the cable to the system board.
- 8 Connect the power-adaptor port cable, fan cable, and speakers cable to the connectors on the system board.
- 9 Align the screw holes on the power-adaptor port bracket with the screw holes on the computer base.
- 10 Replace the screws that secure the power-adaptor port bracket to the computer base.

Postrequisites

- 1 Replace the palm rest. See "Replacing the Palm Rest" on page 31.
- 2 Replace the keyboard. See "Replacing the Keyboard" on page 16.
- 3 Follow the instructions from step 4 to step 5 in "Replacing the Optical Drive" on page 26.
- 4 Follow the instructions from step 4 to step 6 in "Replacing the Hard Drive" on page 23.
- 5 Replace the memory module(s). See "Replacing the Memory Module(s)" on page 20.
- 6 Replace the base cover. See "Replacing the Base Cover" on page 18.
- 7 Replace the battery. See "Replacing the Battery" on page 13.
- 8 Follow the instructions in "After Working Inside Your Computer" on page 9.

Entering the Service Tag in the BIOS

- 1 Turn on the computer.
- 2 Press <F2> during POST to enter the system setup program.
- 3 Navigate to the main tab and enter the Service Tag in the Service Tag Setting field.



WARNING: Before working inside your computer, read the safety information that shipped with your computer and follow the steps in "Before You Begin" on page 7. For additional safety best practices information, see the Regulatory Compliance Homepage at dell.com/regulatory_compliance.

Removing the Thermal-Cooling Assembly

Prerequisites

- 1 Remove the battery. See "Removing the Battery" on page 13.
- 2 Remove the base cover. See "Removing the Base Cover" on page 17.
- 3 Remove the memory module(s). See "Removing the Memory Module(s)" on page 19.
- 4 Follow the instructions from step 1 to step 3 in "Removing the Hard Drive" on page 21.
- 5 Follow the instructions from step 1 to step 2 in "Removing the Optical Drive" on page 25.
- 6 Remove the keyboard. See "Removing the Keyboard" on page 15.
- 7 Remove the palm rest. See "Removing the Palm Rest" on page 27.
- 8 Follow the instructions from step 1 to step 8 in "Removing the System Board" on page 49.

Procedure

- 1 In sequential order (indicated on the thermal-cooling assembly), remove the screws that secure the thermal-cooling assembly to the system board.
- 2 Lift the thermal-cooling assembly off the system board.

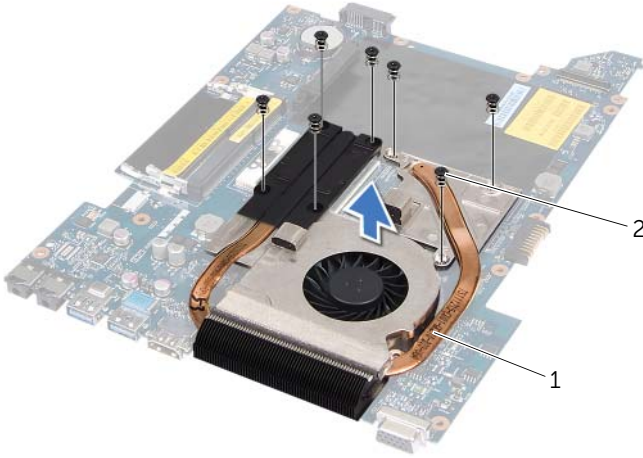

1 thermal-cooling assembly

2 screws (7)

Replacing the Thermal-Cooling Assembly

Procedure

- 1 Align the screw holes on the thermal-cooling assembly with the screw holes on the system board.
- 2 In sequential order (indicated on the thermal-cooling assembly), replace screws that secure the thermal-cooling assembly to the system board.

Postrequisites

- 1 Follow the instructions from step 3 to step 10 in "Replacing the System Board" on page 52.
- 2 Replace the palm rest. See "Replacing the Palm Rest" on page 31.
- 3 Replace the keyboard. See "Replacing the Keyboard" on page 16.
- 4 Follow the instructions from step 4 to step 5 in "Replacing the Optical Drive" on page 26.
- 5 Follow the instructions from step 4 to step 6 in "Replacing the Hard Drive" on page 23.
- 6 Replace the memory module(s). See "Replacing the Memory Module(s)" on page 20.
- 7 Replace the base cover. See "Replacing the Base Cover" on page 18.
- 8 Replace the battery. See "Replacing the Battery" on page 13.
- 9 Follow the instructions in "After Working Inside Your Computer" on page 9.



WARNING: Before working inside your computer, read the safety information that shipped with your computer and follow the steps in "Before You Begin" on page 7. For additional safety best practices information, see the Regulatory Compliance Homepage at dell.com/regulatory_compliance.

Removing the Processor

Prerequisites

- 1 Remove the battery. See "Removing the Battery" on page 13.
- 2 Remove the base cover. See "Removing the Base Cover" on page 17.
- 3 Remove the memory module(s). See "Removing the Memory Module(s)" on page 19.
- 4 Follow the instructions from step 1 to step 3 in "Removing the Hard Drive" on page 21.
- 5 Follow the instructions from step 1 to step 2 in "Removing the Optical Drive" on page 25.
- 6 Remove the keyboard. See "Removing the Keyboard" on page 15.
- 7 Remove the palm rest. See "Removing the Palm Rest" on page 27.
- 8 Follow the instructions from step 1 to step 8 in "Removing the System Board" on page 49.
- 9 Remove the thermal-cooling assembly. See "Removing the Thermal-Cooling Assembly" on page 55.

Procedure

- 1 To loosen the ZIF socket, use a small, flat-blade screwdriver and rotate the ZIF-socket cam screw counterclockwise until it comes to the cam stop.
- △ **CAUTION:** To ensure maximum cooling for the processor, do not touch the heat transfer areas on the processor thermal cooling assembly. The oils in your skin can reduce the heat transfer capability of the thermal pads.
- △ **CAUTION:** When removing the processor module, pull the module straight up. Be careful not to bend the pins on the processor module.
- 2 Lift the processor module from the ZIF socket.

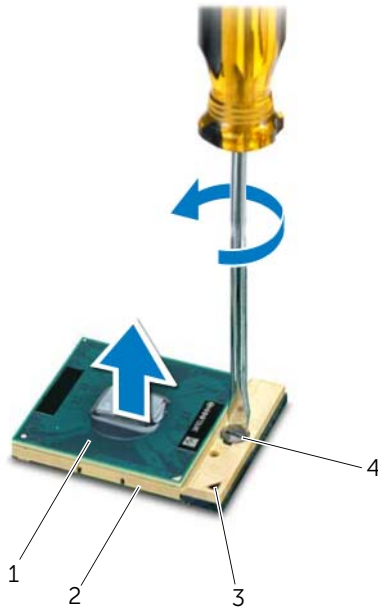

1	processor	2	ZIF socket
3	pin-1 corner	4	ZIF-socket cam screw

Replacing the Processor

Procedure



NOTE: If you install a new processor, a new thermal cooling assembly including an affixed thermal pad or a new thermal pad along with documentation to illustrate proper installation is shipped.

- 1 Align the pin-1 corner of the processor module with the pin-1 corner of the ZIF socket, then insert the processor module.



NOTE: The pin-1 corner of the processor module has a triangle that aligns with the triangle on the pin-1 corner of the ZIF socket.

When the processor module is properly seated, all four corners are aligned at the same height. If one or more corners of the module are higher than the others, the module is not seated properly.



CAUTION: To avoid damage to the processor, hold the screwdriver perpendicular to the processor when turning the cam screw.

- 2 Tighten the ZIF socket by turning the cam screw clockwise to secure the processor module to the system board.

Postrequisites

- 1 Replace the thermal-cooling assembly. See "Replacing the Thermal-Cooling Assembly" on page 57.
- 2 Follow the instructions from step 3 to step 10 in "Replacing the System Board" on page 52.
- 3 Replace the palm rest. See "Replacing the Palm Rest" on page 31.
- 4 Replace the keyboard. See "Replacing the Keyboard" on page 16.
- 5 Follow the instructions from step 4 to step 5 in "Replacing the Optical Drive" on page 26.
- 6 Follow the instructions from step 4 to step 6 in "Replacing the Hard Drive" on page 23.
- 7 Replace the memory module(s). See "Replacing the Memory Module(s)" on page 20.
- 8 Replace the base cover. See "Replacing the Base Cover" on page 18.
- 9 Replace the battery. See "Replacing the Battery" on page 13.
- 10 Follow the instructions in "After Working Inside Your Computer" on page 9.



WARNING: Before working inside your computer, read the safety information that shipped with your computer and follow the steps in "Before You Begin" on page 7. For additional safety best practices information, see the Regulatory Compliance Homepage at dell.com/regulatory_compliance.



WARNING: The battery may explode if installed incorrectly. Replace the battery only with the same or equivalent type. Discard used batteries according to the manufacturer's instructions.

Removing the Coin-Cell Battery



CAUTION: Removing the coin-cell battery resets the BIOS settings to default. It is recommended that you note the BIOS settings before removing the coin-cell battery.

Prerequisites

- 1 Remove the battery. See "Removing the Battery" on page 13.
- 2 Remove the base cover. See "Removing the Base Cover" on page 17.
- 3 Remove the memory module(s). See "Removing the Memory Module(s)" on page 19.
- 4 Follow the instructions from step 1 to step 3 in "Removing the Hard Drive" on page 21.
- 5 Follow the instructions from step 1 to step 2 in "Removing the Optical Drive" on page 25.
- 6 Remove the keyboard. See "Removing the Keyboard" on page 15.
- 7 Remove the palm rest. See "Removing the Palm Rest" on page 27.
- 8 Follow the instructions from step 1 to step 8 in "Removing the System Board" on page 49.

Procedure

Using a plastic scribe, gently pry the coin-cell battery out of the battery socket on the system board.

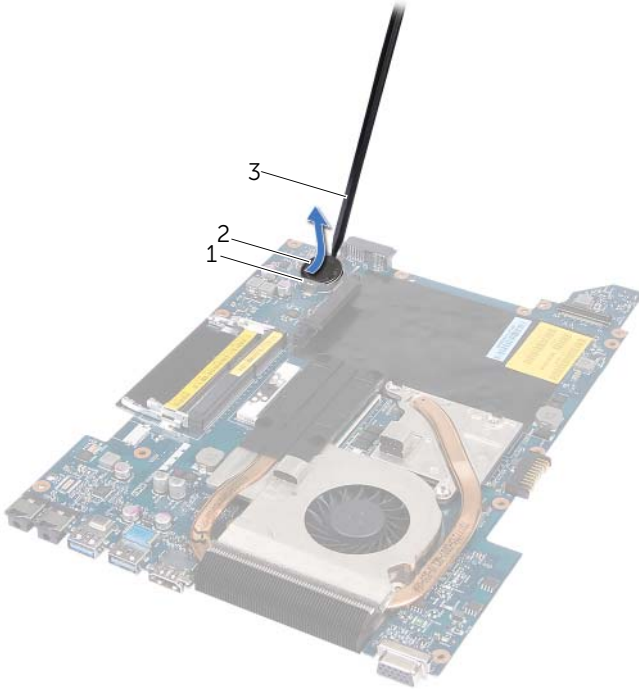

1 battery socket

2 coin-cell battery

3 plastic scribe

Replacing the Coin-Cell Battery

Procedure

With the positive-side facing up, snap the coin-cell battery into the battery socket on the system board.

Postrequisites

- 1 Follow the instructions from step 3 to step 10 in "Replacing the System Board" on page 52.
- 2 Replace the palm rest. See "Replacing the Palm Rest" on page 31.
- 3 Replace the keyboard. See "Replacing the Keyboard" on page 16.
- 4 Follow the instructions from step 4 to step 5 in "Replacing the Optical Drive" on page 26.
- 5 Follow the instructions from step 4 to step 6 in "Replacing the Hard Drive" on page 23.
- 6 Replace the memory module(s). See "Replacing the Memory Module(s)" on page 20.
- 7 Replace the base cover. See "Replacing the Base Cover" on page 18.
- 8 Replace the battery. See "Replacing the Battery" on page 13.
- 9 Follow the instructions in "After Working Inside Your Computer" on page 9.



WARNING: Before working inside your computer, read the safety information that shipped with your computer and follow the steps in "Before You Begin" on page 7. For additional safety best practices information, see the Regulatory Compliance Homepage at dell.com/regulatory_compliance.

Removing the Speakers

Prerequisites

- 1 Remove the battery. See "Removing the Battery" on page 13.
- 2 Remove the base cover. See "Removing the Base Cover" on page 17.
- 3 Remove the memory module(s). See "Removing the Memory Module(s)" on page 19.
- 4 Follow the instructions from step 1 to step 3 in "Removing the Hard Drive" on page 21.
- 5 Follow the instructions from step 1 to step 2 in "Removing the Optical Drive" on page 25.
- 6 Remove the keyboard. See "Removing the Keyboard" on page 15.
- 7 Remove the palm rest. See "Removing the Palm Rest" on page 27.
- 8 Follow the instructions from step 1 to step 8 in "Removing the System Board" on page 49.

Procedure

- 1 Remove the screws that secure the speakers to the computer base.
- 2 Lift the speakers along with its cable away from the computer base.

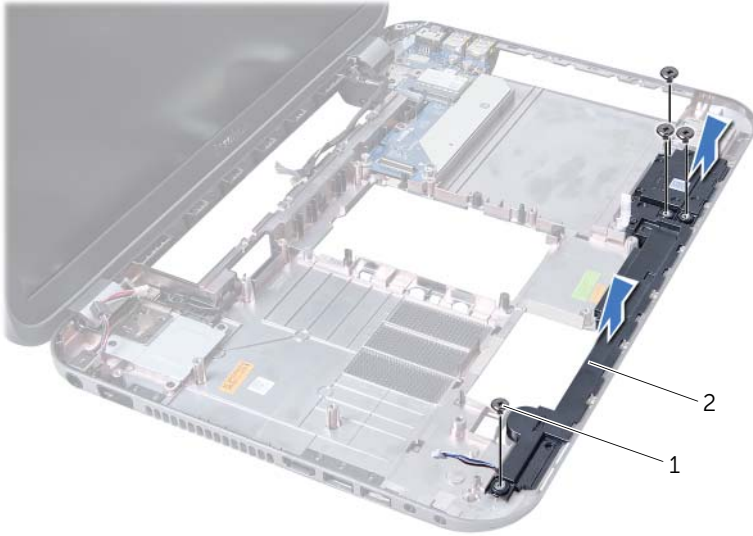

1 screws (4)

2 speakers

Replacing the Speakers

Procedure

- 1 Align the screw holes on the speakers with the screw holes on the computer base and place the speakers on the computer base.
- 2 Replace the screws that secure the speakers to the computer base.

Postrequisites

- 1 Follow the instructions from step 3 to step 10 in "Replacing the System Board" on page 52.
- 2 Replace the palm rest. See "Replacing the Palm Rest" on page 31.
- 3 Replace the keyboard. See "Replacing the Keyboard" on page 16.
- 4 Follow the instructions from step 4 to step 5 in "Replacing the Optical Drive" on page 26.
- 5 Follow the instructions from step 4 to step 6 in "Replacing the Hard Drive" on page 23.
- 6 Replace the memory module(s). See "Replacing the Memory Module(s)" on page 20.
- 7 Replace the base cover. See "Replacing the Base Cover" on page 18.
- 8 Replace the battery. See "Replacing the Battery" on page 13.
- 9 Follow the instructions in "After Working Inside Your Computer" on page 9.



WARNING: Before working inside your computer, read the safety information that shipped with your computer and follow the steps in "Before You Begin" on page 7. For additional safety best practices information, see the Regulatory Compliance Homepage at dell.com/regulatory_compliance.

Removing the Media Card Reader

Prerequisites

- 1 Remove the battery. See "Removing the Battery" on page 13.
- 2 Remove the base cover. See "Removing the Base Cover" on page 17.
- 3 Remove the memory module(s). See "Removing the Memory Module(s)" on page 19.
- 4 Follow the instructions from step 1 to step 3 in "Removing the Hard Drive" on page 21.
- 5 Follow the instructions from step 1 to step 2 in "Removing the Optical Drive" on page 25.
- 6 Remove the keyboard. See "Removing the Keyboard" on page 15.
- 7 Remove the palm rest. See "Removing the Palm Rest" on page 27.
- 8 Follow the instructions from step 1 to step 8 in "Removing the System Board" on page 49.
- 9 Remove the speakers. See "Removing the Speakers" on page 67.

Procedure

- 1 Remove the screw that secures the Media Card Reader to the computer base.
- 2 Make note of the Media Card Reader cable routing.
- 3 Lift the Media Card Reader along with its cable away from the computer base.

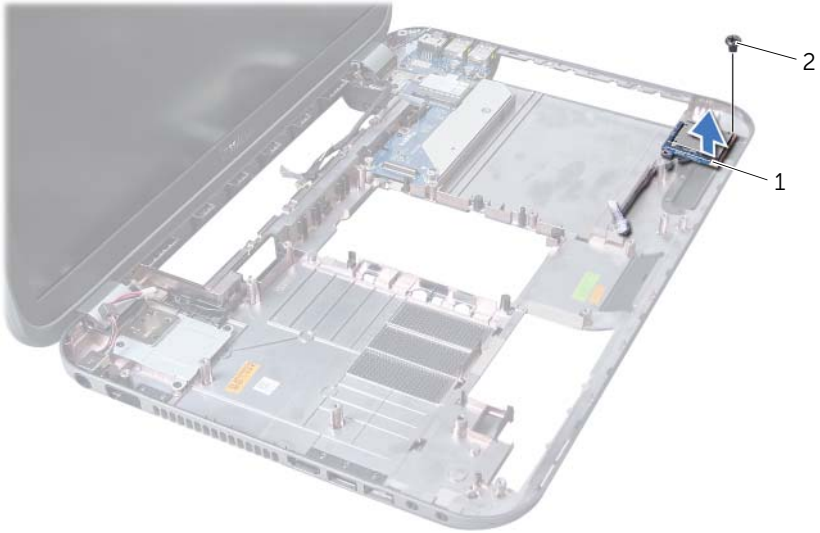

1 Media Card Reader 2 screw

Replacing the Media Card Reader

Procedure

- 1 Align the screw holes on the Media Card Reader with the screw holes on the computer base and place the Media Card Reader on the computer base.
- 2 Replace the screw that secures the Media Card Reader to the computer base.

Postrequisites

- 1 Replace the speakers. See "Replacing the Speakers" on page 69.
- 1 Follow the instructions from step 3 to step 10 in "Replacing the System Board" on page 52.
- 2 Replace the palm rest. See "Replacing the Palm Rest" on page 31.
- 3 Replace the keyboard. See "Replacing the Keyboard" on page 16.
- 4 Follow the instructions from step 4 to step 5 in "Replacing the Optical Drive" on page 26.
- 5 Follow the instructions from step 4 to step 6 in "Replacing the Hard Drive" on page 23.
- 6 Replace the memory module(s). See "Replacing the Memory Module(s)" on page 20.
- 7 Replace the base cover. See "Replacing the Base Cover" on page 18.
- 8 Replace the battery. See "Replacing the Battery" on page 13.
- 9 Follow the instructions in "After Working Inside Your Computer" on page 9.



WARNING: Before working inside your computer, read the safety information that shipped with your computer and follow the steps in "Before You Begin" on page 7. For additional safety best practices information, see the Regulatory Compliance Homepage at dell.com/regulatory_compliance.

Removing the Daughter Board

Prerequisites

- 1 Remove the battery. See "Removing the Battery" on page 13.
- 2 Remove the base cover. See "Removing the Base Cover" on page 17.
- 3 Remove the memory module(s). See "Removing the Memory Module(s)" on page 19.
- 4 Follow the instructions from step 1 to step 3 in "Removing the Hard Drive" on page 21.
- 5 Follow the instructions from step 1 to step 2 in "Removing the Optical Drive" on page 25.
- 6 Remove the keyboard. See "Removing the Keyboard" on page 15.
- 7 Remove the palm rest. See "Removing the Palm Rest" on page 27.
- 8 Remove the Mini-Card. See "Removing the Mini-Card" on page 79.
- 9 Remove the display assembly. See "Removing the Display Assembly" on page 35.
- 10 Follow the instructions from step 1 to step 8 in "Removing the System Board" on page 49.

Procedure

- 1 Remove the screws that secure the daughter board to the computer base.
- 2 Lift the daughter board away from the computer base.

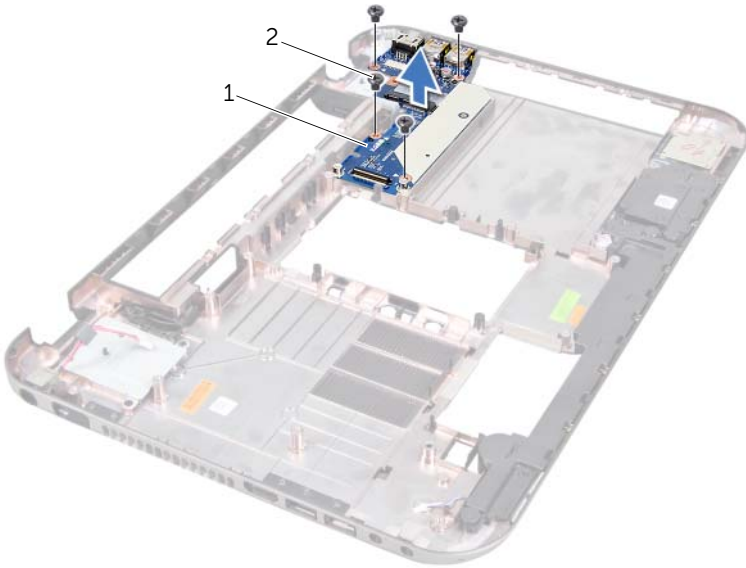

1 daughter board

2 screws (4)

Replacing the Daughter Board

Procedure

- 1 Align the screw holes on the daughter board with the screw holes on the computer base.
- 2 Replace the screws that secure the daughter board to the computer base.

Postrequisites

- 1 Replace the display assembly. See "Replacing the Display Assembly" on page 37.
- 2 Follow the instructions from step 3 to step 10 in "Replacing the System Board" on page 52.
- 3 Replace the Mini-Card. See "Replacing the Mini-Card" on page 80.
- 4 Replace the palm rest. See "Replacing the Palm Rest" on page 31.
- 5 Replace the keyboard. See "Replacing the Keyboard" on page 16.
- 6 Follow the instructions from step 4 to step 5 in "Replacing the Optical Drive" on page 26.
- 7 Follow the instructions from step 4 to step 6 in "Replacing the Hard Drive" on page 23.
- 8 Replace the memory module(s). See "Replacing the Memory Module(s)" on page 20.
- 9 Replace the base cover. See "Replacing the Base Cover" on page 18.
- 10 Replace the battery. See "Replacing the Battery" on page 13.
- 11 Follow the instructions in "After Working Inside Your Computer" on page 9.

WARNING: Before working inside your computer, read the safety information that shipped with your computer and follow the steps in "Before You Begin" on page 7. For additional safety best practices information, see the Regulatory Compliance Homepage at dell.com/regulatory_compliance.

NOTE: Dell does not guarantee compatibility or provide support for Mini-Cards from sources other than Dell.

If you ordered a wireless Mini-Card with your computer, the card is already installed. Your computer has one half Mini-Card slot which supports a Wireless Local Area Network (WLAN) + Bluetooth combo card, Wi-Fi, and Worldwide Interoperability for Microwave Access (WiMax) cards.

Removing the Mini-Card

Prerequisites

- 1 Remove the battery. See "Removing the Battery" on page 13.
- 2 Remove the keyboard. See "Removing the Keyboard" on page 15.
- 3 Remove the base cover. See "Removing the Base Cover" on page 17.
- 4 Remove the palm rest. See "Removing the Palm Rest" on page 27.

Procedure

- 1 Disconnect the antenna cables from the connectors on the Mini-Card.
- 2 Remove the screw that secures the Mini-Card to the connector on the daughter board.

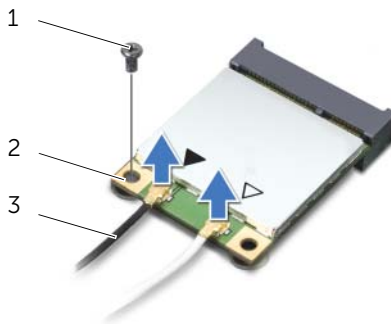

1	screw	2	Mini-Card
3	antenna cables (2)		

- 3 Lift the Mini-Card out of the connector on the daughter board.

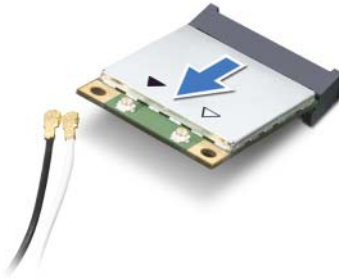

- △ CAUTION:** When the Mini-Card is not in the computer, store it in protective antistatic packaging. For more information, see "Protecting Against Electrostatic Discharge" in the safety information that shipped with your computer.

Replacing the Mini-Card

Procedure

- 1 Remove the new Mini-Card from its packaging.
- 2 Align the notch on the Mini-Card with the tab on the connector on the daughter board.

- △ CAUTION:** Use firm and even pressure to slide the Mini-Card into place. If you use excessive force, you may damage the connector.

- △ CAUTION:** The connectors are keyed to ensure correct insertion. If you feel resistance, check the connectors on the Mini-Card and on the daughter board, and realign the Mini-Card.

- △ CAUTION:** To avoid damage to the Mini-Card, never place cables under the wireless Mini-Card.

- 3 Insert the Mini-Card connector at a 45-degree angle into the connector on the daughter board.

- 4 Press the other end of the Mini-Card down into the slot on the daughter board and replace the screw that secures the Mini-Card to the daughter board.
- 5 Connect the antenna cables to the connectors on the Mini-Card.
The following table provides the wireless antenna cable color scheme for the Mini-Cards supported by your computer.

Connectors on the Mini-Card	Antenna Cable Color Scheme
WLAN + Bluetooth (2 cables)	
Main WLAN + Bluetooth (white triangle)	white
Auxiliary WLAN + Bluetooth (black triangle)	black
WWAN (2 antenna cables)	
Main WWAN (white triangle)	white
Auxiliary WWAN (black triangle)	black

Postrequisites

- 1 Replace the palm rest. See "Replacing the Palm Rest" on page 31.
- 2 Replace the base cover. See "Replacing the Base Cover" on page 18.
- 3 Replace the keyboard. See "Replacing the Keyboard" on page 16.
- 4 Replace the battery. See "Replacing the Battery" on page 13.
- 5 Follow the instructions in "After Working Inside Your Computer" on page 9.

The BIOS may require flashing when an update is available or when replacing the system board.

To flash the BIOS:

- 1 Turn on the computer.
- 2 Go to **support.dell.com/support/downloads**.
- 3 Locate the BIOS update file for your computer:



NOTE: The Service Tag for your computer is located on a label at the bottom of your computer. For more information, see the *Quick Start Guide* that shipped with your computer.

If you have your computer's Service Tag or Express Service Code:

- a Enter your computer's Service Tag or Express Service Code in the **Service Tag or Express Service Code** field.
- b Click **Submit** and proceed to step 4.

If you do not have your computer's Service Tag or Express Service Code:

- a Select one of the following options:
 - **Automatically detect my Service Tag for me**
 - **Choose from My Products and Services List**
 - **Choose from a list of all Dell products**
 - b Click **Continue** and follow the instructions on the screen.
- 4 A list of results appears on the screen. Click **BIOS**.
 - 5 Click Download File to download the latest BIOS file.
 - 6 In the **Please select your download method below** window, click **For Single File Download via Browser**, and then click **Download Now**.
 - 7 In the **Save As** window, select an appropriate location to download the file on your computer.
 - 8 If the **Download Complete** window appears, click **Close**.
 - 9 Navigate to the folder where you downloaded the BIOS update file. The file icon appears in the folder and is titled the same as the downloaded BIOS update file.
 - 10 Double-click the BIOS update file icon and follow the instructions that appear on the screen.

