

Dell™ Inspiron™ N4110

Service Manual

Regulatory model: P20G

Regulatory type: P20G001



Notes, Cautions, and Warnings



NOTE: A NOTE indicates important information that helps you make better use of your computer.



CAUTION: A CAUTION indicates potential damage to hardware or loss of data if instructions are not followed.



WARNING: A WARNING indicates a potential for property damage, personal injury, or death.

Information in this document is subject to change without notice.

© 2011 Dell Inc. All rights reserved.

Trademarks used in this text: Dell™, the DELL logo, and Inspiron™ are trademarks of Dell Inc.; Microsoft®, Windows®, and the Windows start button logo  are either trademarks or registered trademarks of Microsoft Corporation in the United States and/or other countries.

Reproduction of these materials in any manner whatsoever without the written permission of Dell Inc. is strictly forbidden.

Regulatory model: P20G

Regulatory type: P20G001

2011-02

Rev. A00

Contents

1	Before You Begin	9
	Recommended Tools	9
	Turning Off Your Computer	9
	Before Working Inside Your Computer	10
2	Top Cover	13
	Removing the Top Cover	13
	Replacing the Top Cover	14
3	Battery	15
	Removing the Battery	15
	Replacing the Battery	16
4	Module Cover	17
	Removing the Module Cover	17
	Replacing the Module Cover	18
5	Optical Drive	19
	Removing the Optical Drive	19

	Replacing the Optical Drive	21
6	Memory Module(s).	23
	Removing the Memory Module(s)	23
	Replacing the Memory Module(s)	24
7	Keyboard	27
	Removing the Keyboard	27
	Replacing the Keyboard	29
8	Palm-Rest Assembly	31
	Removing the Palm-Rest Assembly	31
	Replacing the Palm-Rest Assembly	34
9	Hot-Key Board	37
	Removing the Hot-Key Board	37
	Replacing the Hot-Key Board	38
10	Power Button Board	41
	Removing the Power Button Board	41
	Replacing the Power Button Board	42

11	Wireless Mini-Card(s)	45
	Removing the Mini-Card(s)	45
	Replacing the Mini-Card(s)	47
12	Thermal Fan	49
	Removing the Thermal Fan	49
	Replacing the Thermal Fan	50
13	Display	53
	Display Assembly	53
	Removing the Display Assembly	53
	Replacing the Display Assembly	56
	Display Bezel	57
	Removing the Display Bezel	57
	Replacing the Display Bezel	58
	Display Panel	58
	Removing the Display Panel	58
	Replacing the Display Panel	59
	Display Cable	60
	Removing the Display Cable	60
	Replacing the Display Cable	60
	Hinge Caps	61
	Removing the Hinge Caps	61
	Replacing the Hinge Caps	62
	Display Brackets	62

	Removing the Display Brackets	62
	Replacing the Display Brackets	63
14	Camera Module	65
	Removing the Camera Module.	65
	Replacing the Camera Module	66
15	Hinge Cover	69
	Removing the Hinge Cover.	69
	Replacing the Hinge Cover	71
16	VGA Connector Board	73
	Removing the VGA Connector Board	73
	Replacing the VGA Connector Board	74
17	System Board	77
	Removing the System Board.	77
	Replacing the System Board.	81
	Entering the Service Tag in the BIOS	82
18	Speakers	83
	Removing the Speakers	83
	Replacing the Speakers	84

19	Coin-Cell Battery	87
	Removing the Coin-Cell Battery	87
	Replacing the Coin-Cell Battery	88
20	Thermal Cooling Assembly	89
	Removing the Thermal Cooling Assembly	89
	Replacing the Thermal Cooling Assembly	90
21	Processor Module	91
	Removing the Processor Module	91
	Replacing the Processor Module	92
22	Hard-Drive Assembly	95
	Removing the Hard-Drive Assembly.	95
	Replacing the Hard-Drive Assembly	97
23	I/O Board	99
	Removing the I/O Board	99
	Replacing the I/O Board	100
24	AC-Adapter Connector	101
	Removing the AC-Adapter Connector	101

Replacing the AC-Adapter Connector	102
25 Flashing the BIOS	105

Before You Begin

This manual provides procedures for removing and installing components in your computer. Unless otherwise noted, each procedure assumes that the following conditions exist:

- You have performed the steps in "Turning Off Your Computer" on page 9 and "Before Working Inside Your Computer" on page 10.
- You have read the safety information that shipped with your computer.
- A component can be replaced or—if purchased separately—installed by performing the removal procedure in the reverse order.

Recommended Tools

The procedures in this document may require the following tools:

- Small flat-blade screwdriver
- Phillips screwdriver
- Plastic scribe
- BIOS executable update program available at support.dell.com

Turning Off Your Computer

 **CAUTION: To avoid losing data, save and close all open files and exit all open programs before you turn off your computer.**

- 1 Save and close all open files and exit all open programs.
- 2 Click the Start button  and then click **Shut Down**.

The computer turns off after the operating system shutdown process finishes.

- 3 Ensure that the computer is turned off. If your computer did not automatically turn off when you shut down the operating system, press and hold the power button until the computer turns off.

Before Working Inside Your Computer

Use the following safety guidelines to help protect your computer from potential damage and to help to ensure your own personal safety.

 **WARNING:** Before working inside your computer, read the safety information that shipped with your computer. For additional safety best practices information, see the Regulatory Compliance Homepage at dell.com/regulatory_compliance.

 **CAUTION:** To avoid electrostatic discharge, ground yourself by using a wrist grounding strap or by periodically touching an unpainted metal surface (such as a connector on your computer).

 **CAUTION:** Handle components and cards with care. Do not touch the components or contacts on a card. Hold a card by its edges or by its metal mounting bracket. Hold a component such as a processor by its edges, not by its pins.

 **CAUTION:** Only a certified service technician should perform repairs on your computer. Damage due to servicing that is not authorized by Dell is not covered by your warranty.

 **CAUTION:** When you disconnect a cable, pull on its connector or on its pull-tab, not on the cable itself. Some cables have connectors with locking tabs; if you are disconnecting this type of cable, press in on the locking tabs before you disconnect the cable. As you pull connectors apart, keep them evenly aligned to avoid bending any connector pins. Also, before you connect a cable, ensure that both connectors are correctly oriented and aligned.

 **CAUTION:** To avoid damaging the computer, perform the following steps before you begin working inside the computer.

- 1 Ensure that the work surface is flat and clean to prevent the computer cover from being scratched.
- 2 Turn off your computer (see "Turning Off Your Computer" on page 9) and all attached devices.





 **CAUTION:** To disconnect a network cable, first unplug the cable from your computer and then unplug the cable from the network device.

- 3 Disconnect all telephone or network cables from the computer.
- 4 Press and eject any installed cards from the 8-in-1 media card reader.
- 5 Disconnect your computer and all attached devices from their electrical outlets.
- 6 Disconnect all attached devices from your computer.

 **CAUTION: To help prevent damage to the system board, remove the main battery (see "Removing the Battery" on page 15) before working inside the computer.**

- 7** Remove the battery (see "Removing the Battery" on page 15).
- 8** Turn the computer top-side up, open the display, and press the power button to ground the system board.

Top Cover

-  **WARNING:** Before working inside your computer, read the safety information that shipped with your computer. For additional safety best practices information, see the Regulatory Compliance Homepage at dell.com/regulatory_compliance.
-  **CAUTION:** Only a certified service technician should perform repairs on your computer. Damage due to servicing that is not authorized by Dell is not covered by your warranty.
-  **CAUTION:** To avoid electrostatic discharge, ground yourself by using a wrist grounding strap or by periodically touching an unpainted metal surface (such as a connector on your computer).
-  **CAUTION:** To help prevent damage to the system board, remove the main battery (see "Removing the Battery" on page 15) before working inside the computer.

Removing the Top Cover

- 1 Follow the instructions in "Before You Begin" on page 9.
- 2 Press and hold the release button that secures the top cover to the display back cover.
- 3 Slide and lift the top cover.



- 1 top cover 2 release button

Replacing the Top Cover





- 1 Follow the instructions in "Before You Begin" on page 9.

 **NOTE:** Ensure that the Dell logo is facing towards the back of the computer while replacing the top cover.

- 2 Align the top cover to the display back cover.
- 3 Slide the top cover until it clicks into place. Ensure that there are no gaps between the top cover and display back cover.

 **CAUTION:** Before turning on the computer, replace all screws and ensure that no stray screws remain inside the computer. Failure to do so may result in damage to the computer.

Battery

-  **WARNING:** Before working inside your computer, read the safety information that shipped with your computer. For additional safety best practices information, see the Regulatory Compliance Homepage at dell.com/regulatory_compliance.
-  **CAUTION:** Only a certified service technician should perform repairs on your computer. Damage due to servicing that is not authorized by Dell is not covered by your warranty.
-  **CAUTION:** To avoid electrostatic discharge, ground yourself by using a wrist grounding strap or by periodically touching an unpainted metal surface (such as a connector on your computer).
-  **CAUTION:** To avoid damage to the computer, use only the battery designed for this particular Dell computer. Do not use batteries designed for other Dell computers.

Removing the Battery

- 1 Follow the instructions in "Before You Begin" on page 9.
- 2 Shut down the computer and turn it over.
- 3 Slide the battery lock latch until it clicks into place.
- 4 Slide the battery release latch to the unlock position.
- 5 Slide and lift the battery out of the battery bay.

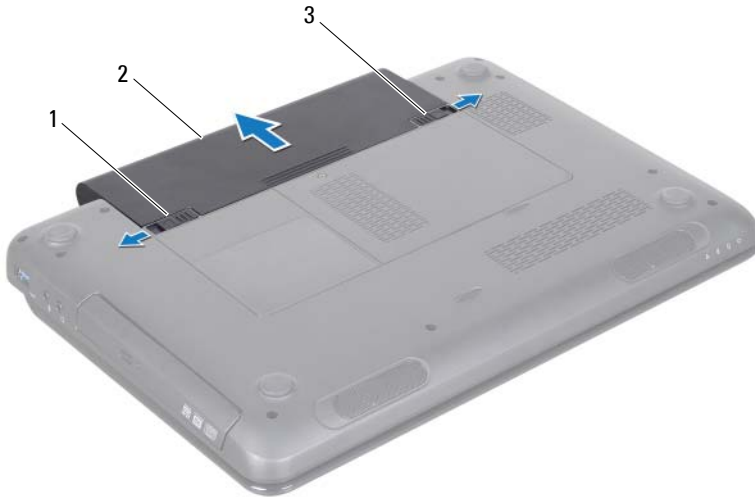





- 1 battery release latch
- 2 battery
- 3 battery lock latch

Replacing the Battery

- 1 Follow the instructions in "Before You Begin" on page 9.
- 2 Slide the battery into the battery bay until it clicks into place.
- 3 Slide the battery lock latch to the lock position.

Module Cover

-  **WARNING:** Before working inside your computer, read the safety information that shipped with your computer. For additional safety best practices information, see the Regulatory Compliance Homepage at dell.com/regulatory_compliance.
-  **CAUTION:** Only a certified service technician should perform repairs on your computer. Damage due to servicing that is not authorized by Dell is not covered by your warranty.
-  **CAUTION:** To avoid electrostatic discharge, ground yourself by using a wrist grounding strap or by periodically touching an unpainted metal surface (such as a connector on your computer).
-  **CAUTION:** To help prevent damage to the system board, remove the main battery (see "Removing the Battery" on page 15) before working inside the computer.

Removing the Module Cover

- 1 Follow the instructions in "Before You Begin" on page 9.
- 2 Remove the battery (see "Removing the Battery" on page 15).
- 3 Loosen the captive screw that secures the module cover to the computer base.
- 4 Using your fingertips, release the tabs on the module cover from the slots on the computer base.
- 5 Lift the module cover off the computer base.

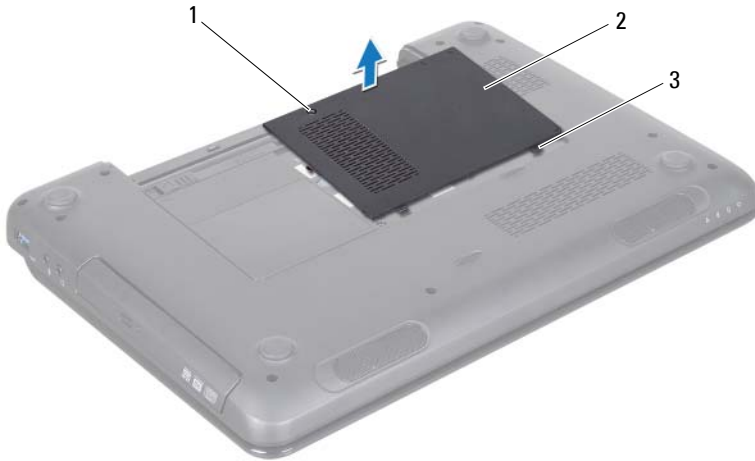

- 1 captive screw
- 2 module cover
- 3 tabs (2)





Replacing the Module Cover

- 1 Follow the instructions in "Before You Begin" on page 9.
- 2 Align the tabs on the module cover with the slots on the computer base and gently snap the cover in place.
- 3 Tighten the captive screw that secures the module cover to the computer base.
- 4 Replace the battery (see "Replacing the Battery" on page 16).



CAUTION: Before turning on the computer, replace all screws and ensure that no stray screws remain inside the computer. Failure to do so may result in damage to the computer.

Optical Drive

-  **WARNING:** Before working inside your computer, read the safety information that shipped with your computer. For additional safety best practices information, see the Regulatory Compliance Homepage at dell.com/regulatory_compliance.
-  **CAUTION:** Only a certified service technician should perform repairs on your computer. Damage due to servicing that is not authorized by Dell is not covered by your warranty.
-  **CAUTION:** To avoid electrostatic discharge, ground yourself by using a wrist grounding strap or by periodically touching an unpainted metal surface (such as a connector on your computer).
-  **CAUTION:** To help prevent damage to the system board, remove the main battery (see "Removing the Battery" on page 15) before working inside the computer.

Removing the Optical Drive

- 1 Follow the instructions in "Before You Begin" on page 9.
- 2 Remove the battery (see "Removing the Battery" on page 15).
- 3 Remove the module cover (see "Removing the Module Cover" on page 17).
- 4 Remove the screw that secures the optical-drive assembly to the computer base.
- 5 Slide the optical-drive assembly out of the optical-drive compartment.



1 optical-drive assembly 2 screw

- 6 Remove the two screws that secure the optical-drive bracket to the optical drive.
- 7 Pull the optical-drive bezel to detach it from the optical drive.

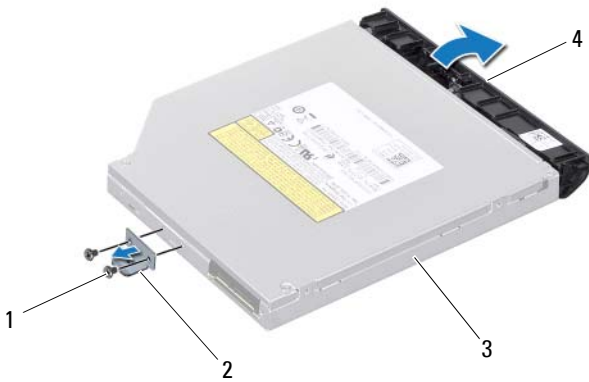

- | | | | |
|---|---------------|---|-----------------------|
| 1 | screws (2) | 2 | optical-drive bracket |
| 3 | optical drive | 4 | optical-drive bezel |

Replacing the Optical Drive

- 1 Follow the instructions in "Before You Begin" on page 9.
- 2 Align the tabs on the optical-drive bezel with the slots on the optical drive and snap the optical-drive bezel into place.
- 3 Align the screw holes on the optical-drive bracket with the screw holes on the optical drive and replace the two screws.
- 4 Slide the optical-drive assembly into the optical-drive compartment until it is fully seated.
- 5 Replace the screw that secures the optical-drive assembly to the computer base.
- 6 Replace the module cover (see "Replacing the Module Cover" on page 18).
- 7 Replace the battery (see "Replacing the Battery" on page 16).





CAUTION: Before turning on the computer, replace all screws and ensure that no stray screws remain inside the computer. Failure to do so may result in damage to the computer.

Memory Module(s)

 **WARNING:** Before working inside your computer, read the safety information that shipped with your computer. For additional safety best practices information, see the Regulatory Compliance Homepage at dell.com/regulatory_compliance.

 **CAUTION:** Only a certified service technician should perform repairs on your computer. Damage due to servicing that is not authorized by Dell is not covered by your warranty.

 **CAUTION:** To avoid electrostatic discharge, ground yourself by using a wrist grounding strap or by periodically touching an unpainted metal surface (such as a connector on your computer).

 **CAUTION:** To help prevent damage to the system board, remove the main battery (see "Removing the Battery" on page 15) before working inside the computer.

You can increase your computer memory by installing memory modules on the system board. See "Specifications" in your *Setup Guide* for information on the type of memory supported by your computer.

 **NOTE:** Memory modules purchased from Dell are covered under your computer warranty.

Your computer has two user-accessible SO-DIMM sockets, labeled DIMM A and DIMM B, that can be accessed from the bottom of the computer.

Removing the Memory Module(s)

- 1 Follow the instructions in "Before You Begin" on page 9.
- 2 Remove the battery (see "Removing the Battery" on page 15).
- 3 Remove the module cover (see "Removing the Module Cover" on page 17).

 **CAUTION:** To prevent damage to the memory module connector, do not use tools to spread the memory module securing clips.

- 4 Use your fingertips to carefully spread apart the securing clips on each end of the memory-module connector until the module pops up.
- 5 Remove the memory module(s) from the memory-module connector.

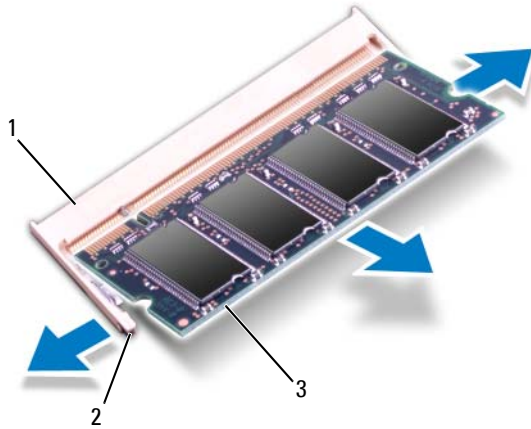

- 1 memory-module connector 2 securing clips (2)
3 memory module

Replacing the Memory Module(s)

CAUTION: If you need to install memory modules in two connectors, install a memory module in the connector labeled “DIMM A” before you install a memory module in the connector labeled “DIMM B.”

- 1 Follow the instructions in "Before You Begin" on page 9.
- 2 Align the notch in the memory module with the tab in the memory-module connector.
- 3 Slide the memory module firmly into the slot at a 45-degree angle, and press the memory module down until it clicks into place. If you do not hear the click, remove the memory module and reinstall it.



NOTE: If the memory module is not installed properly, the computer may not boot.

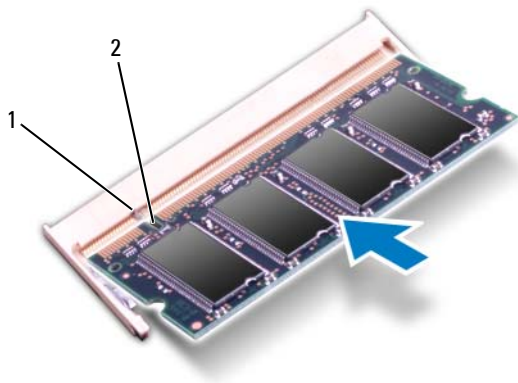

1 tab 2 notch

4 Replace the module cover (see "Replacing the Module Cover" on page 18).

5 Replace the battery (see "Replacing the Battery" on page 16), or connect the AC adapter to your computer and an electrical outlet.

⚠ CAUTION: Before turning on the computer, replace all screws and ensure that no stray screws remain inside the computer. Failure to do so may result in damage to the computer.





6 Turn on the computer.

As the computer boots, it detects the memory module(s) and automatically updates the system configuration information.



To confirm the amount of memory installed in the computer:

Click Start  → Control Panel → System and Security → System.

Keyboard

-  **WARNING:** Before working inside your computer, read the safety information that shipped with your computer. For additional safety best practices information, see the Regulatory Compliance Homepage at dell.com/regulatory_compliance.
-  **CAUTION:** Only a certified service technician should perform repairs on your computer. Damage due to servicing that is not authorized by Dell is not covered by your warranty.
-  **CAUTION:** To avoid electrostatic discharge, ground yourself by using a wrist grounding strap or by periodically touching an unpainted metal surface (such as a connector on your computer).
-  **CAUTION:** To help prevent damage to the system board, remove the main battery (see "Removing the Battery" on page 15) before working inside the computer.

Removing the Keyboard

- 1 Follow the instructions in "Before You Begin" on page 9.
- 2 Remove the battery (see "Removing the Battery" on page 15).
-  **CAUTION:** The keycaps on the keyboard are fragile, easily dislodged, and time-consuming to replace. Be careful when removing and handling the keyboard.
- 3 Turn the computer over and open the display as far as possible.
-  **CAUTION:** Do not slide the plastic scribe under the keyboard tabs to remove the keyboard as it may cause permanent damage to the keyboard tabs.
- 4 Slide a plastic scribe between the slots on the keyboard and release the tabs on the palm rest.
- 5 Pry and lift the keyboard to disengage it from the tabs on the palm rest.

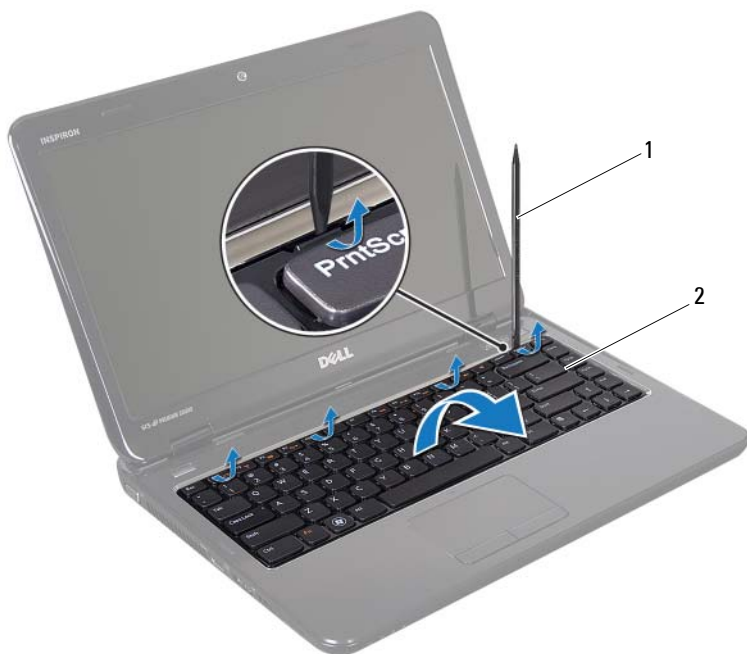

- 1 plastic scribe 2 keyboard

CAUTION: Be extremely careful when removing and handling the keyboard. Failure to do so could result in scratching the display panel.

- 6 Ease the keyboard up until it clears off the palm rest.
- 7 Carefully turn the keyboard over and place it on the palm-rest assembly.
- 8 Lift the connector latch that secures the keyboard cable to the connector on the system board and disconnect the keyboard cable.
- 9 Lift the keyboard off the computer.







- 1 keyboard cable 2 keyboard-cable connector

Replacing the Keyboard

- 1 Follow the instructions in "Before You Begin" on page 9.
- 2 Slide the keyboard cable into the connector on the system board.
Press down on the connector latch to secure the keyboard cable to the connector on the system board.
- 3 Slide the tabs on the keyboard into the slots on the palm-rest assembly.
- 4 Gently press around the edges of the keyboard and slide it upwards to secure the keyboard under the tabs on the palm-rest assembly.
- 5 Close the display and turn the computer over.

6 Replace the battery (see "Replacing the Battery" on page 16).

Palm-Rest Assembly

-  **WARNING:** Before working inside your computer, read the safety information that shipped with your computer. For additional safety best practices information, see the Regulatory Compliance Homepage at dell.com/regulatory_compliance.
-  **CAUTION:** Only a certified service technician should perform repairs on your computer. Damage due to servicing that is not authorized by Dell is not covered by your warranty.
-  **CAUTION:** To avoid electrostatic discharge, ground yourself by using a wrist grounding strap or by periodically touching an unpainted metal surface (such as a connector on your computer).
-  **CAUTION:** To help prevent damage to the system board, remove the main battery (see "Removing the Battery" on page 15) before working inside the computer.

Removing the Palm-Rest Assembly

- 1 Follow the instructions in "Before You Begin" on page 9.
- 2 Remove the battery (see "Removing the Battery" on page 15).
- 3 Remove the module cover (see "Removing the Module Cover" on page 17).
- 4 Follow the instructions from step 4 to step 5 in "Removing the Optical Drive" on page 19.
- 5 Remove the ten screws from the computer base.
- 6 Remove the keyboard (see "Removing the Keyboard" on page 27).



- 7 Remove the five screws on the palm-rest assembly.

CAUTION: Pull on the plastic tab on top of the connectors to avoid damaging the connectors.

- 8 Lift the connector latches and pull the pull-tabs to disconnect the power-button cable, touch-pad cable, and hot-key board cable from the connectors on the system board.

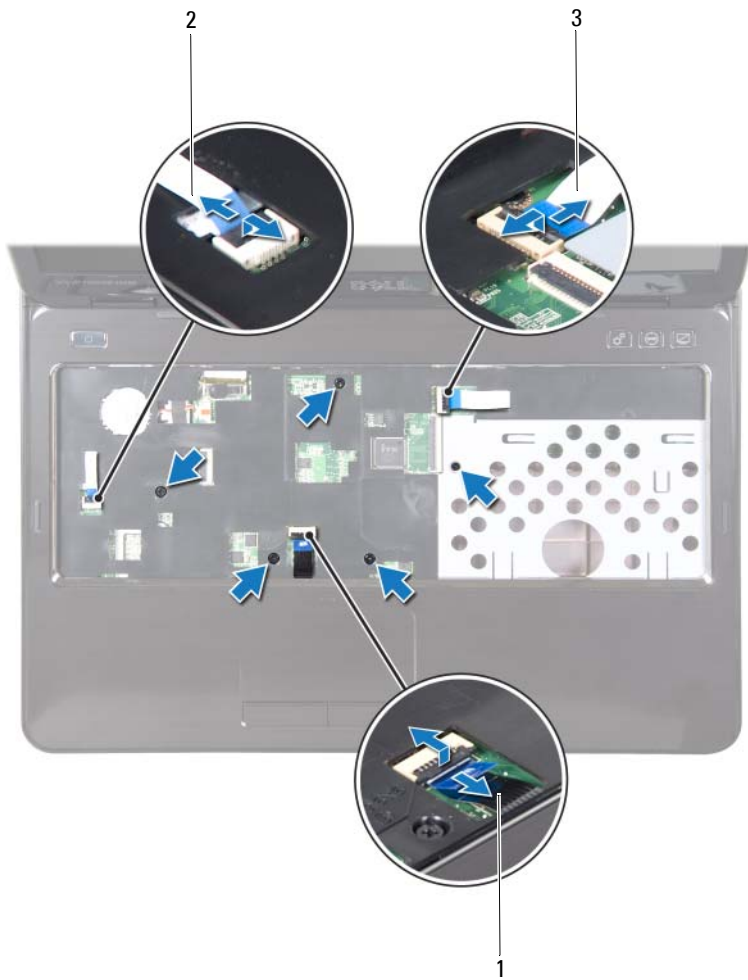

- 1 touch-pad cable
- 3 hot-key board cable

- 2 power-button cable

CAUTION: Carefully separate the palm rest from the computer base to avoid damage to the palm rest.

- 9 Using a plastic scribe, carefully pry out the palm-rest assembly along the rear edge and then ease the palm-rest assembly from the computer base.
- 10 Lift the palm-rest assembly off the computer base.
- 11 Turn the palm-rest assembly over.
- 12 Remove the hot-key board (see "Removing the Hot-Key Board" on page 37).
- 13 Remove the power button board (see "Removing the Power Button Board" on page 41).



1 plastic scribe

2 palm-rest assembly





Replacing the Palm-Rest Assembly

- 1 Follow the instructions in "Before You Begin" on page 9.
- 2 Replace the power button board (see "Replacing the Power Button Board" on page 42).
- 3 Replace the hot-key board (see "Replacing the Hot-Key Board" on page 38).
- 4 Align the tabs on the palm-rest assembly with the slots on the computer base and gently snap the palm-rest assembly in place.
- 5 Slide the power-button cable, touch-pad cable, and hot-key board cable into the connectors on the system board and press down on the connector latches to secure them.
- 6 Replace the five screws on the palm-rest assembly.
- 7 Replace the keyboard (see "Replacing the Keyboard" on page 29).
- 8 Turn the computer over and replace the ten screws at the bottom of the computer.
- 9 Follow the instructions from step 4 to step 5 in "Replacing the Optical Drive" on page 21.
- 10 Replace the module cover (see "Replacing the Module Cover" on page 18).
- 11 Replace the battery (see "Replacing the Battery" on page 16).



CAUTION: Before turning on the computer, replace all screws and ensure that no stray screws remain inside the computer. Failure to do so may result in damage to the computer.

Hot-Key Board

-  **WARNING:** Before working inside your computer, read the safety information that shipped with your computer. For additional safety best practices information, see the Regulatory Compliance Homepage at dell.com/regulatory_compliance.
-  **CAUTION:** Only a certified service technician should perform repairs on your computer. Damage due to servicing that is not authorized by Dell is not covered by your warranty.
-  **CAUTION:** To avoid electrostatic discharge, ground yourself by using a wrist grounding strap or by periodically touching an unpainted metal surface (such as a connector on your computer).
-  **CAUTION:** To help prevent damage to the system board, remove the main battery (see "Removing the Battery" on page 15) before working inside the computer.

Removing the Hot-Key Board

- 1 Follow the instructions in "Before You Begin" on page 9.
- 2 Remove the battery (see "Removing the Battery" on page 15).
- 3 Remove the module cover (see "Removing the Module Cover" on page 17).
- 4 Follow the instructions from step 4 to step 5 in "Removing the Optical Drive" on page 19.
- 5 Remove the keyboard (see "Removing the Keyboard" on page 27).
- 6 Remove the palm-rest assembly (see "Removing the Palm-Rest Assembly" on page 31).
- 7 Turn the palm-rest assembly over.
- 8 Remove the hot-key board cable from the slot on the palm-rest assembly.
- 9 Remove the screw that secures the hot-key board to the palm-rest assembly.
- 10 Lift the hot-key board off the palm-rest assembly.

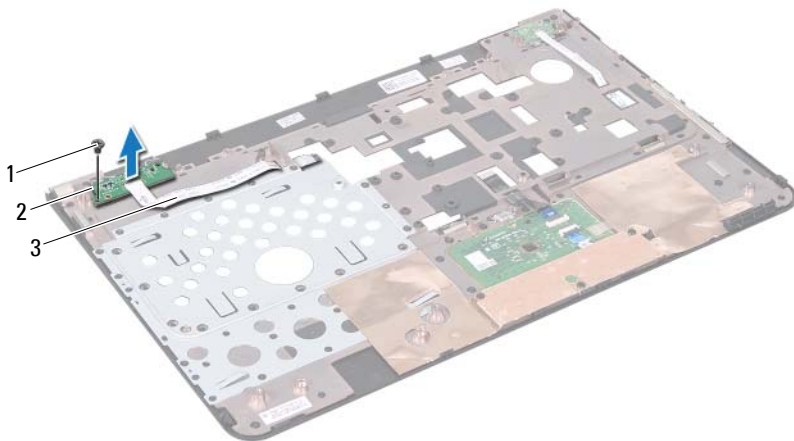





- 1 screw
- 2 hot-key board
- 3 hot-key board cable

Replacing the Hot-Key Board

- 1 Follow the instructions in "Before You Begin" on page 9.
- 2 Align the slots on the hot-key board with the alignment posts on the palm-rest assembly and replace the screw.
- 3 Route the hot-key board cable through the slot on the palm-rest assembly.
- 4 Turn the palm-rest assembly over.
- 5 Replace the palm-rest assembly (see "Replacing the Palm-Rest Assembly" on page 35).
- 6 Replace the keyboard (see "Replacing the Keyboard" on page 29).
- 7 Follow the instructions from step 4 to step 5 in "Replacing the Optical Drive" on page 21.
- 8 Replace the module cover (see "Replacing the Module Cover" on page 18).
- 9 Replace the battery (see "Replacing the Battery" on page 16).

 **CAUTION:** Before turning on the computer, replace all screws and ensure that no stray screws remain inside the computer. Failure to do so may result in damage to the computer.

Power Button Board

-  **WARNING:** Before working inside your computer, read the safety information that shipped with your computer. For additional safety best practices information, see the Regulatory Compliance Homepage at dell.com/regulatory_compliance.
-  **CAUTION:** Only a certified service technician should perform repairs on your computer. Damage due to servicing that is not authorized by Dell is not covered by your warranty.
-  **CAUTION:** To avoid electrostatic discharge, ground yourself by using a wrist grounding strap or by periodically touching an unpainted metal surface (such as a connector on your computer).
-  **CAUTION:** To help prevent damage to the system board, remove the main battery (see "Removing the Battery" on page 15) before working inside the computer.

Removing the Power Button Board

- 1 Follow the instructions in "Before You Begin" on page 9.
- 2 Remove the battery (see "Removing the Battery" on page 15).
- 3 Remove the module cover (see "Removing the Module Cover" on page 17).
- 4 Follow the instructions from step 4 to step 5 in "Removing the Optical Drive" on page 19.
- 5 Remove the keyboard (see "Removing the Keyboard" on page 27).
- 6 Remove the palm-rest assembly (see "Removing the Palm-Rest Assembly" on page 31).
- 7 Turn the palm-rest assembly over.
- 8 Remove the power-button board cable from the slot on the palm-rest assembly.
- 9 Remove the screw that secures the power button board to the palm-rest assembly.

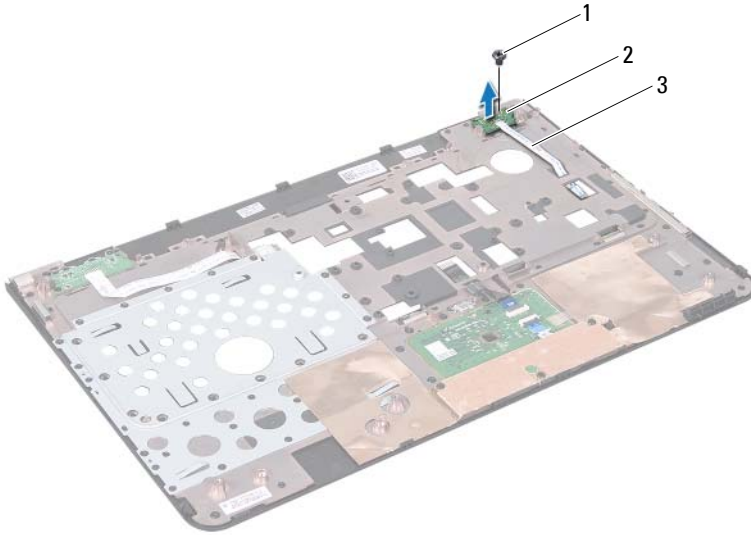

- 1 screw
- 2 power button board
- 3 power-button board cable

Replacing the Power Button Board

- 1 Follow the instructions in "Before You Begin" on page 9.
- 2 Align the slots on the power button board with the alignment posts on the palm-rest assembly and replace the screw.
- 3 Route the power-button board cable through the slot on the palm-rest assembly.
- 4 Turn the palm-rest assembly over.
- 5 Replace the palm-rest assembly (see "Replacing the Palm-Rest Assembly" on page 35).
- 6 Replace the keyboard (see "Replacing the Keyboard" on page 29).
- 7 Follow the instructions from step 4 to step 5 in "Replacing the Optical Drive" on page 21.

8 Replace the module cover (see "Replacing the Module Cover" on page 18).

9 Replace the battery (see "Removing the Battery" on page 15).





CAUTION: Before turning on the computer, replace all screws and ensure that no stray screws remain inside the computer. Failure to do so may result in damage to the computer.

Wireless Mini-Card(s)

 **WARNING:** Before working inside your computer, read the safety information that shipped with your computer. For additional safety best practices information, see the Regulatory Compliance Homepage at dell.com/regulatory_compliance.

 **CAUTION:** Only a certified service technician should perform repairs on your computer. Damage due to servicing that is not authorized by Dell is not covered by your warranty.

 **CAUTION:** To avoid electrostatic discharge, ground yourself by using a wrist grounding strap or by periodically touching an unpainted metal surface (such as a connector on your computer).

 **CAUTION:** To help prevent damage to the system board, remove the main battery (see "Removing the Battery" on page 15) before working inside the computer.

 **NOTE:** Dell does not guarantee compatibility or provide support for Mini-Cards from sources other than Dell.

If you ordered a wireless Mini-Card with your computer, the card is already installed.

Your computer has one full Mini-Card slot and one half Mini-Card slot:

- One full Mini-Card slot — supports Worldwide Interoperability for Microwave Access (WiMax).
- One half Mini-Card slot — supports Wireless Local Area Network (WLAN).

 **NOTE:** Depending on the configuration of the computer when it was sold, the Mini-Card slot may or may not have a Mini-Card installed.

Removing the Mini-Card(s)

- 1 Follow the instructions in "Before You Begin" on page 9.
- 2 Remove the battery (see "Removing the Battery" on page 15).
- 3 Remove the module cover (see "Removing the Module Cover" on page 17).

- 4 Follow the instructions from step 4 to step 5 in "Removing the Optical Drive" on page 19.
- 5 Remove the keyboard (see "Removing the Keyboard" on page 27).
- 6 Remove the palm-rest assembly (see "Removing the Palm-Rest Assembly" on page 31).
- 7 Disconnect the two antenna cables from the Mini-Card(s).
- 8 Remove the screw that secures the Mini-Card(s) to the system board.
- 9 Lift the Mini-Card(s) off the computer base.

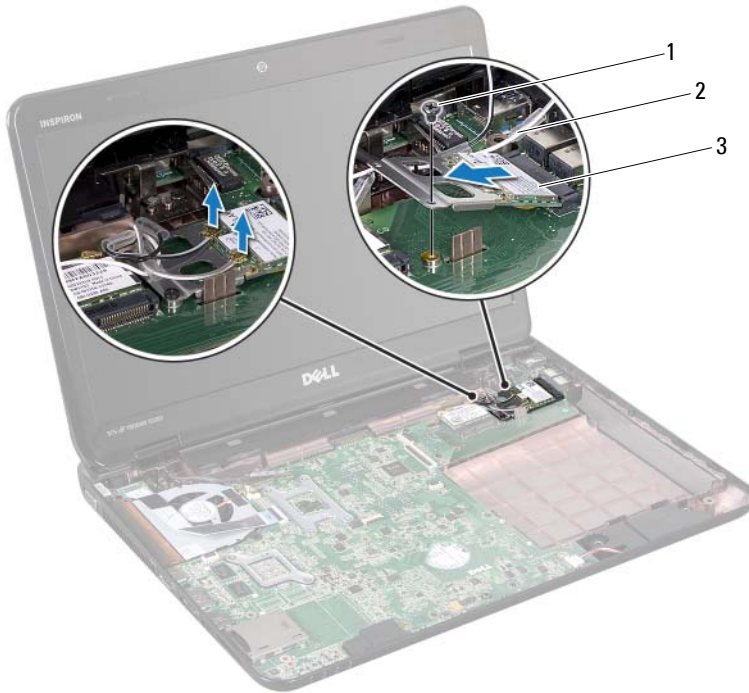

- 1 screw
- 2 antenna cables (2)
- 3 Mini-Card

- 10 If you are removing the WLAN Mini-Card, detach it from the WLAN Mini-Card bracket.

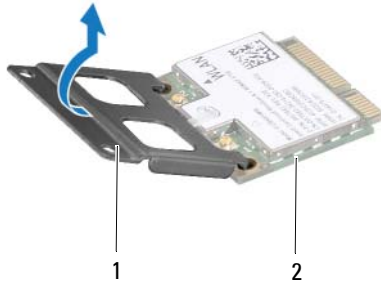

- 1 Mini-Card bracket
- 2 Mini-Card

CAUTION: When the Mini-Card is not in the computer, store it in protective antistatic packaging. For more information, see "Protecting Against Electrostatic Discharge" in the safety information that shipped with your computer.

Replacing the Mini-Card(s)

- 1 Follow the instructions in "Before You Begin" on page 9.
- 2 Remove the new Mini-Card from its packaging.

CAUTION: Use firm and even pressure to slide the card into place. If you use excessive force, you may damage the connector.

CAUTION: The connectors are keyed to ensure correct insertion. If you feel resistance, check the connectors on the card and on the system board, and realign the card.

CAUTION: To avoid damage to the Mini-Card, never place cables under the card.

- 3 If you are replacing the WLAN Mini-Card, attach it to the WLAN Mini-Card bracket.
- 4 Insert the Mini-Card connector at a 45-degree angle into the system-board connector.

- 5 Press the other end of the Mini-Card down into the slot on the system board and replace the screw that secures the Mini-Card to the system board.
- 6 Connect the appropriate antenna cables to the Mini-Card you are installing.
The following table provides the antenna cable color scheme for the Mini-Cards supported by your computer.





Connectors on the Mini-Card	Antenna Cable Color Scheme
WLAN (2 antenna cables)	
Main WLAN (white triangle)	white
Auxiliary WLAN (black triangle)	black
WiMax (2 antenna cables)	
Main WiMax (white triangle)	white with gray stripe
Auxiliary WiMax (black triangle)	black with gray stripe

- 7 Replace the palm-rest assembly (see "Replacing the Palm-Rest Assembly" on page 35).
 - 8 Replace the keyboard (see "Replacing the Keyboard" on page 29).
 - 9 Follow the instructions from step 4 to step 5 in "Replacing the Optical Drive" on page 21.
 - 10 Replace the module cover (see "Replacing the Module Cover" on page 18).
 - 11 Replace the battery (see "Replacing the Battery" on page 16).
-  **CAUTION: Before turning on the computer, replace all screws and ensure that no stray screws remain inside the computer. Failure to do so may result in damage to the computer.**
- 12 Install the drivers and utilities for your computer, as required.



NOTE: If you are installing a communication card from a source other than Dell, you must install the appropriate drivers and utilities.

Thermal Fan

-  **WARNING:** Before working inside your computer, read the safety information that shipped with your computer. For additional safety best practices information, see the Regulatory Compliance Homepage at dell.com/regulatory_compliance.
-  **CAUTION:** Only a certified service technician should perform repairs on your computer. Damage due to servicing that is not authorized by Dell is not covered by your warranty.
-  **CAUTION:** To avoid electrostatic discharge, ground yourself by using a wrist grounding strap or by periodically touching an unpainted metal surface (such as a connector on your computer).
-  **CAUTION:** To help prevent damage to the system board, remove the main battery (see "Removing the Battery" on page 15) before working inside the computer.

Removing the Thermal Fan

- 1 Follow the instructions in "Before You Begin" on page 9.
- 2 Remove the battery (see "Removing the Battery" on page 15).
- 3 Remove the keyboard (see "Removing the Keyboard" on page 27).
- 4 Remove the palm-rest assembly (see "Removing the Palm-Rest Assembly" on page 31).
- 5 Disconnect the display cable from the connector on the system board.
- 6 Disconnect the thermal fan cable from the connector on the system board.
- 7 Remove the screw that secures the thermal fan to the computer base.
- 8 Lift the thermal fan off the system board.

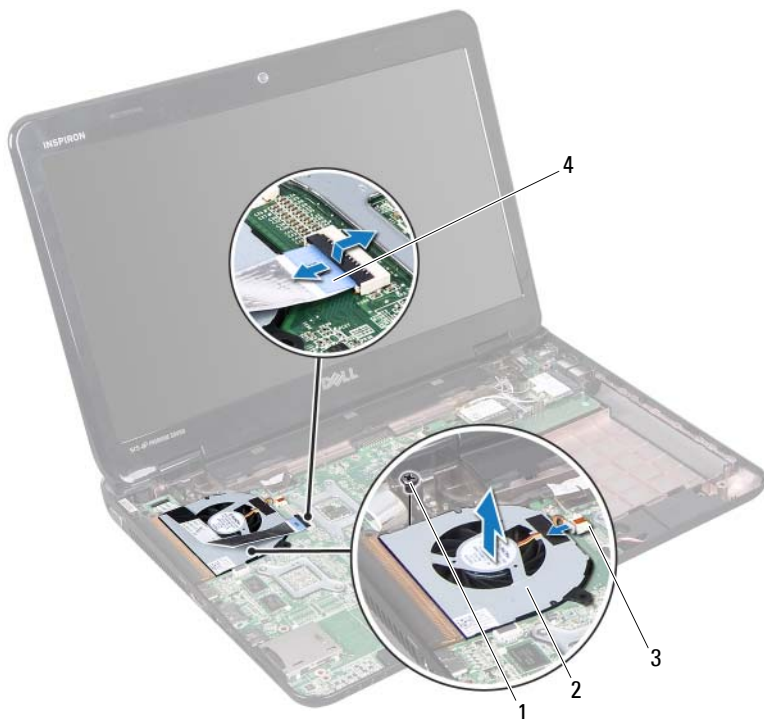

- | | | | |
|---|-----------------------|---|---------------|
| 1 | screw | 2 | thermal fan |
| 3 | thermal fan connector | 4 | display cable |

Replacing the Thermal Fan

- 1 Follow the instructions in "Before You Begin" on page 9.
- 2 Place the thermal fan on the computer base and replace the screw.
- 3 Connect the thermal fan cable to the connector on the system board.
- 4 Connect the display cable to the connector on the system board.
- 5 Replace the palm-rest assembly (see "Replacing the Palm-Rest Assembly" on page 35).





6 Replace the keyboard (see "Replacing the Keyboard" on page 29).

7 Replace the battery (see "Replacing the Battery" on page 16).



CAUTION: Before turning on the computer, replace all screws and ensure that no stray screws remain inside the computer. Failure to do so may result in damage to the computer.

Display

-  **WARNING:** Before working inside your computer, read the safety information that shipped with your computer. For additional safety best practices information, see the Regulatory Compliance Homepage at dell.com/regulatory_compliance.
-  **CAUTION:** Only a certified service technician should perform repairs on your computer. Damage due to servicing that is not authorized by Dell is not covered by your warranty.
-  **CAUTION:** To avoid electrostatic discharge, ground yourself by using a wrist grounding strap or by periodically touching an unpainted metal surface (such as a connector on your computer).
-  **CAUTION:** To help prevent damage to the system board, remove the main battery (see "Removing the Battery" on page 15) before working inside the computer.

Display Assembly

Removing the Display Assembly

- 1 Follow the instructions in "Before You Begin" on page 9.
- 2 Remove the battery (see "Removing the Battery" on page 15).
- 3 Remove the module cover (see "Removing the Module Cover" on page 17).
- 4 Follow the instructions from step 4 to step 5 in "Removing the Optical Drive" on page 19.
- 5 Remove the two screws from the computer base.



- 6** Remove the keyboard (see "Removing the Keyboard" on page 27).
- 7** Remove the palm-rest assembly (see "Removing the Palm-Rest Assembly" on page 31).
- 8** Loosen the display cable grounding screw.
- 9** Disconnect the display cable from the connector on the system board.
- 10** Disconnect the Mini-Card antenna cables from the connectors on the Mini-Card(s) (see "Removing the Mini-Card(s)" on page 45).

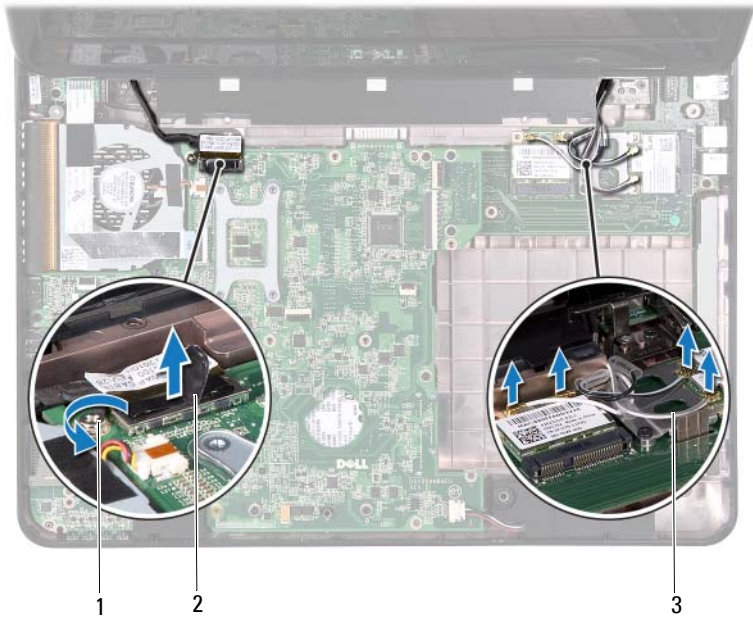

- 1 display cable grounding screw
- 3 Mini-Card antenna cables (4)

2 display-cable connector

- 11** Remove the four screws that secure the display assembly to the computer base.
- 12** Lift the display assembly off the computer base.



- 1 display assembly 2 screws (4)

Replacing the Display Assembly

- 1 Follow the instructions in "Before You Begin" on page 9.
- 2 Place the display assembly in position and replace the four screws that secure the display assembly to the computer base.
- 3 Route the display cable and Mini-Card antenna cables through the routing guides.
- 4 Connect the display cable to the connector on the system board.
- 5 Connect the Mini-Card antenna cables to the Mini-Cards(s) (see "Replacing the Mini-Card(s)" on page 47).
- 6 Tighten the display cable grounding screw.

- 7 Replace the palm-rest assembly (see "Replacing the Palm-Rest Assembly" on page 35).
 - 8 Replace the keyboard (see "Replacing the Keyboard" on page 29).
 - 9 Replace the two screws at the bottom of the computer.
 - 10 Follow the instructions from step 4 to step 5 in "Replacing the Optical Drive" on page 21.
 - 11 Replace the module cover (see "Replacing the Module Cover" on page 18).
 - 12 Replace the battery (see "Replacing the Battery" on page 16).
-  **CAUTION: Before turning on the computer, replace all screws and ensure that no stray screws remain inside the computer. Failure to do so may result in damage to the computer.**

Display Bezel

Removing the Display Bezel

- 1 Follow the instructions in "Before You Begin" on page 9.
 - 2 Remove the top cover (see "Removing the Top Cover" on page 13).
 - 3 Remove the display assembly (see "Removing the Display Assembly" on page 53).
-  **CAUTION: The display bezel is extremely fragile. Be careful when removing it to prevent damaging the display bezel.**
- 4 Using your fingertips, carefully pry up the inside edge of the display bezel.
 - 5 Remove the display bezel.



- 1 display bezel

Replacing the Display Bezel

- 1 Follow the instructions in "Before You Begin" on page 9.
- 2 Realign the display bezel over the display panel and gently snap it into place.
- 3 Replace the display assembly (see "Replacing the Display Assembly" on page 56).
- 4 Replace the top cover (see "Replacing the Top Cover" on page 14).

Display Panel

Removing the Display Panel

- 1 Follow the instructions in "Before You Begin" on page 9.

- 2 Remove the display assembly (see "Removing the Display Assembly" on page 53).
- 3 Remove the display bezel (see "Removing the Display Bezel" on page 57).
- 4 Remove the six screws that secure the display panel to the display cover.
- 5 Note the routing of the display cable and Mini-Card(s) cables and remove the cables from the routing guides on the display cover.
- 6 Lift the display panel off the display cover.



- 1 display cover 2 display panel
3 screws (6)

Replacing the Display Panel

- 1 Follow the instructions in "Before You Begin" on page 9.
- 2 Align the screw holes on the display panel with the screw holes on the display cover and replace the six screws.
- 3 Route the display cable through the routing guides on the display cover.
- 4 Replace the display bezel (see "Replacing the Display Bezel" on page 58).
- 5 Replace the display assembly (see "Replacing the Display Assembly" on page 56).

CAUTION: Before turning on the computer, replace all screws and ensure that no stray screws remain inside the computer. Failure to do so may result in damage to the computer.

Display Cable

Removing the Display Cable

- 1 Follow the instructions in "Before You Begin" on page 9.
- 2 Remove the display assembly (see "Removing the Display Assembly" on page 53).
- 3 Remove the display bezel (see "Removing the Display Bezel" on page 57).
- 4 Remove the display panel (see "Removing the Display Panel" on page 58).
- 5 Turn the display panel over and place it on a clean surface.
- 6 Lift the tape that secures the display cable to the connector on the display panel and disconnect the display cable.



1 tape 2 display cable

Replacing the Display Cable

- 1 Follow the instructions in "Before You Begin" on page 9.
- 2 Connect the display cable to the connector on the display panel and secure it with the tape.
- 3 Turn the display panel over and place it on the display cover.
- 4 Replace the display panel (see "Replacing the Display Panel" on page 59).
- 5 Replace the display bezel (see "Replacing the Display Bezel" on page 58).
- 6 Replace the display assembly (see "Replacing the Display Assembly" on page 56).



CAUTION: Before turning on the computer, replace all screws and ensure that no stray screws remain inside the computer. Failure to do so may result in damage to the computer.

Hinge Caps

Removing the Hinge Caps

- 1 Follow the instructions in "Before You Begin" on page 9.
- 2 Remove the display assembly (see "Removing the Display Assembly" on page 53).
- 3 Remove the display bezel (see "Removing the Display Bezel" on page 57).
- 4 Remove the six screws that secure the display panel to the display cover.
- 5 Turn the display panel over and keep it on a clean surface.
- 6 Press both sides of each hinge cap and lift the hinge caps out of the display hinges.

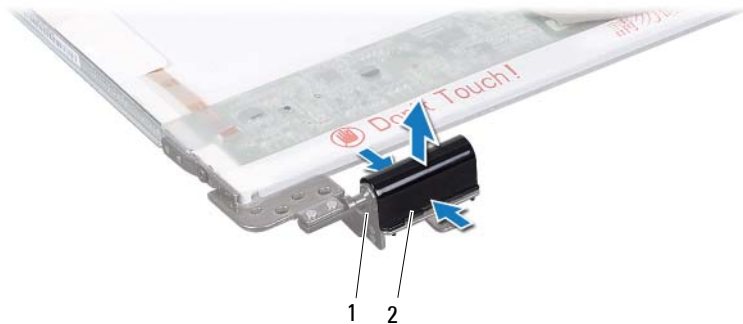

- 1 display hinges (2) 2 hinge caps (2)

Replacing the Hinge Caps

- 1 Follow the instructions in "Before You Begin" on page 9.
- 2 Align the tabs on the hinge caps with the slots on the display panel brackets and snap them into place.
- 3 Turn the display panel over and place it on the display cover.
- 4 Replace the six screws that secure the display panel to the display cover.
- 5 Replace the display bezel (see "Replacing the Display Bezel" on page 58).
- 6 Replace the display assembly (see "Replacing the Display Assembly" on page 56).



CAUTION: Before turning on the computer, replace all screws and ensure that no stray screws remain inside the computer. Failure to do so may result in damage to the computer.

Display Panel Brackets

Removing the Display Panel Brackets

- 1 Follow the instructions in "Before You Begin" on page 9.
- 2 Remove the display assembly (see "Removing the Display Assembly" on page 53).

- 3 Remove the display bezel (see "Removing the Display Bezel" on page 57).
- 4 Remove the hinge caps (see "Removing the Hinge Caps" on page 61).
- 5 Remove the four screws (two on each side) that secure the display panel brackets to the display panel.



- 1 display panel brackets (2) 2 screws (4)

Replacing the Display Panel Brackets





- 1 Follow the instructions in "Before You Begin" on page 9.
- 2 Align the screw holes on the display panel brackets with the screw holes on the display panel.
- 3 Replace the four screws (two on each side) that secure the display-panel brackets to the display panel.
- 4 Replace the hinge caps (see "Replacing the Hinge Caps" on page 62).
- 5 Replace the display bezel (see "Replacing the Display Bezel" on page 58).

6 Replace the display assembly (see "Replacing the Display Assembly" on page 56).



CAUTION: Before turning on the computer, replace all screws and ensure that no stray screws remain inside the computer. Failure to do so may result in damage to the computer.

Camera Module

-  **WARNING:** Before working inside your computer, read the safety information that shipped with your computer. For additional safety best practices information, see the Regulatory Compliance Homepage at dell.com/regulatory_compliance.
-  **CAUTION:** Only a certified service technician should perform repairs on your computer. Damage due to servicing that is not authorized by Dell is not covered by your warranty.
-  **CAUTION:** To avoid electrostatic discharge, ground yourself by using a wrist grounding strap or by periodically touching an unpainted metal surface (such as a connector on your computer).
-  **CAUTION:** To help prevent damage to the system board, remove the main battery (see "Removing the Battery" on page 15) before working inside the computer.

Removing the Camera Module

- 1 Follow the instructions in "Before You Begin" on page 9.
- 2 Remove the battery (see "Removing the Battery" on page 15).
- 3 Remove the module cover (see "Removing the Module Cover" on page 17).
- 4 Follow the instructions from step 4 to step 5 in "Removing the Optical Drive" on page 19.
- 5 Remove the keyboard (see "Removing the Keyboard" on page 27).
- 6 Remove the palm-rest assembly (see "Removing the Palm-Rest Assembly" on page 31).
- 7 Remove the display assembly (see "Removing the Display Assembly" on page 53).
- 8 Remove the display bezel (see "Removing the Display Bezel" on page 57).
- 9 Using a plastic scribe, pry the camera module from the display back cover.
- 10 Lift the camera and remove the tape that secures the camera cable to the camera module.
- 11 Disconnect the camera cable from the connector on the camera module.

12 Remove the camera module.

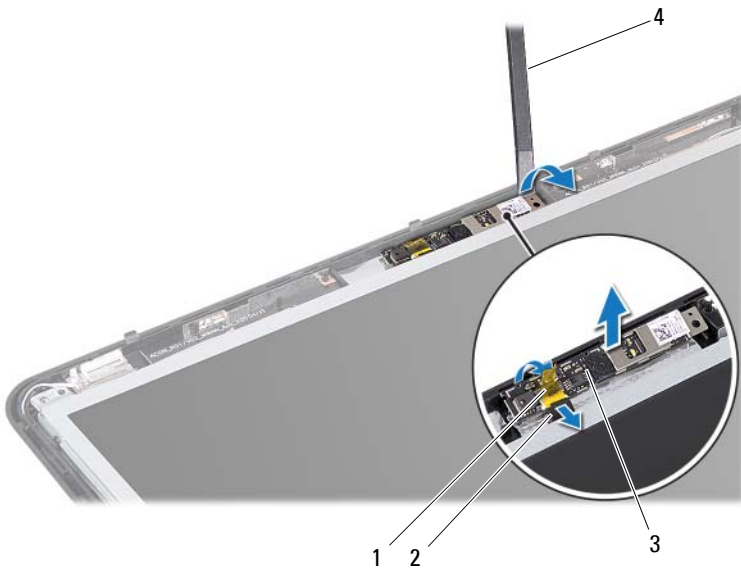

- | | | | |
|---|---------------|---|----------------|
| 1 | tape | 2 | camera cable |
| 3 | camera module | 4 | plastic scribe |

Replacing the Camera Module





- 1 Follow the instructions in "Before You Begin" on page 9.
- 2 Connect the camera cable to the connector on the camera module.
- 3 Adhere the tape that secures the camera cable to the camera module.
- 4 Align the slots on the camera module with the alignment posts on the display cover.
- 5 Replace the display bezel (see "Replacing the Display Bezel" on page 58).
- 6 Replace the display assembly (see "Replacing the Display Assembly" on page 56).

- 7** Replace the palm-rest assembly (see "Replacing the Palm-Rest Assembly" on page 35).
- 8** Replace the keyboard (see "Replacing the Keyboard" on page 29).
- 9** Follow the instructions from step 4 to step 5 in "Replacing the Optical Drive" on page 21.
- 10** Replace the module cover (see "Replacing the Module Cover" on page 18).
- 11** Replace the battery (see "Replacing the Battery" on page 16).



CAUTION: Before turning on the computer, replace all screws and ensure that no stray screws remain inside the computer. Failure to do so may result in damage to the computer.

Hinge Cover

-  **WARNING:** Before working inside your computer, read the safety information that shipped with your computer. For additional safety best practices information, see the Regulatory Compliance Homepage at dell.com/regulatory_compliance.
-  **CAUTION:** To avoid electrostatic discharge, ground yourself by using a wrist grounding strap or by periodically touching an unpainted metal surface.
-  **CAUTION:** Only a certified service technician should perform repairs on your computer. Damage due to servicing that is not authorized by Dell is not covered by your warranty.
-  **CAUTION:** To help prevent damage to the system board, remove the main battery (see "Removing the Battery" on page 15) before working inside the computer.

Removing the Hinge Cover

- 1 Follow the instructions in "Before You Begin" on page 9.
- 2 Remove the battery (see "Removing the Battery" on page 15).
- 3 Remove the module cover (see "Removing the Module Cover" on page 17).
- 4 Follow the instructions from step 4 to step 5 in "Removing the Optical Drive" on page 19.
- 5 Remove the keyboard (see "Removing the Keyboard" on page 27).
- 6 Remove the palm-rest assembly (see "Removing the Palm-Rest Assembly" on page 31).
- 7 Remove the display assembly (see "Removing the Display Assembly" on page 53).
- 8 Remove the two screws from the computer base.



9 Release the two tabs that secure the hinge cover to the computer base.

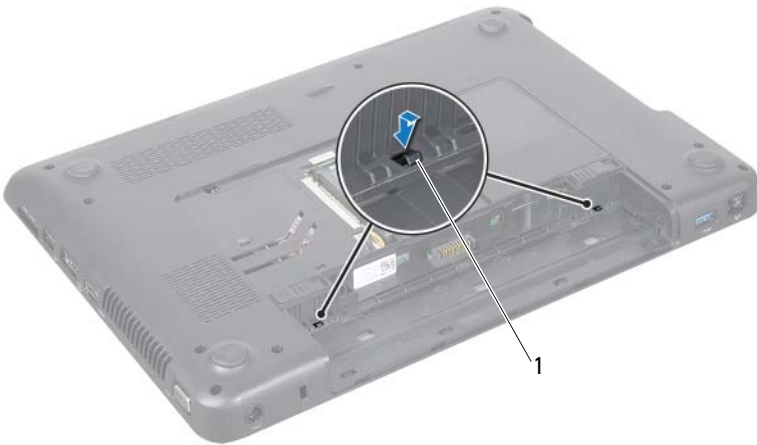

1 tabs (2)

10 Lift the hinge cover off the computer base.

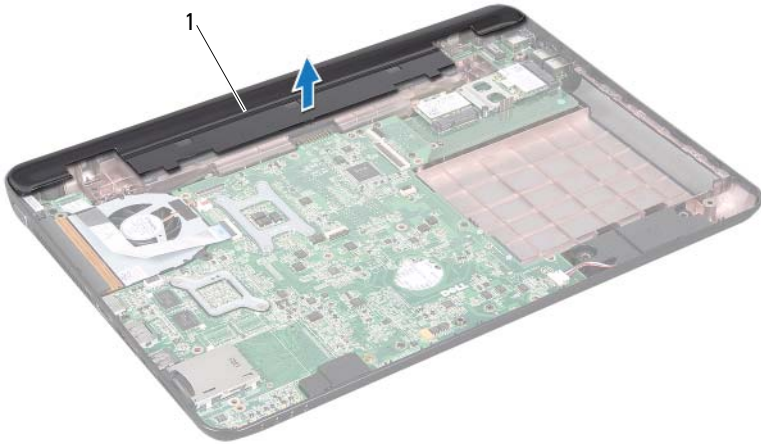

- 1 hinge cover





Replacing the Hinge Cover

- 1 Follow the instructions in "Before You Begin" on page 9.
- 2 Align the two tabs on the hinge cover with the slots on the computer base and snap the hinge cover into place.
- 3 Replace the two screws at the bottom of the computer.
- 4 Replace the display assembly (see "Replacing the Display Assembly" on page 56).
- 5 Replace the palm-rest assembly (see "Replacing the Palm-Rest Assembly" on page 35).
- 6 Replace the keyboard (see "Replacing the Keyboard" on page 29).
- 7 Follow the instructions from step 4 to step 5 in "Replacing the Optical Drive" on page 21.
- 8 Replace the module cover (see "Replacing the Module Cover" on page 18).
- 9 Replace the battery (see "Replacing the Battery" on page 16).



CAUTION: Before turning on the computer, replace all screws and ensure that no stray screws remain inside the computer. Failure to do so may result in damage to the computer.

VGA Connector Board

-  **WARNING:** Before working inside your computer, read the safety information that shipped with your computer. For additional safety best practices information, see the Regulatory Compliance Homepage at dell.com/regulatory_compliance.
-  **CAUTION:** Only a certified service technician should perform repairs on your computer. Damage due to servicing that is not authorized by Dell is not covered by your warranty.
-  **CAUTION:** To avoid electrostatic discharge, ground yourself by using a wrist grounding strap or by periodically touching an unpainted metal surface (such as a connector on your computer).
-  **CAUTION:** To help prevent damage to the system board, remove the main battery (see "Removing the Battery" on page 15) before working inside the computer.

Removing the VGA Connector Board

- 1 Follow the instructions in "Before You Begin" on page 9.
- 2 Remove the battery (see "Removing the Battery" on page 15).
- 3 Remove the keyboard (see "Removing the Keyboard" on page 27).
- 4 Remove the palm-rest assembly (see "Removing the Palm-Rest Assembly" on page 31).
- 5 Remove the display assembly (see "Removing the Display Assembly" on page 53).
- 6 Remove the hinge cover (see "Removing the Hinge Cover" on page 69).
- 7 Remove the screw that secures the VGA connector board to the system board.
- 8 Disconnect the display cable from the connector on the system board.
- 9 Lift the VGA connector board off the system board.

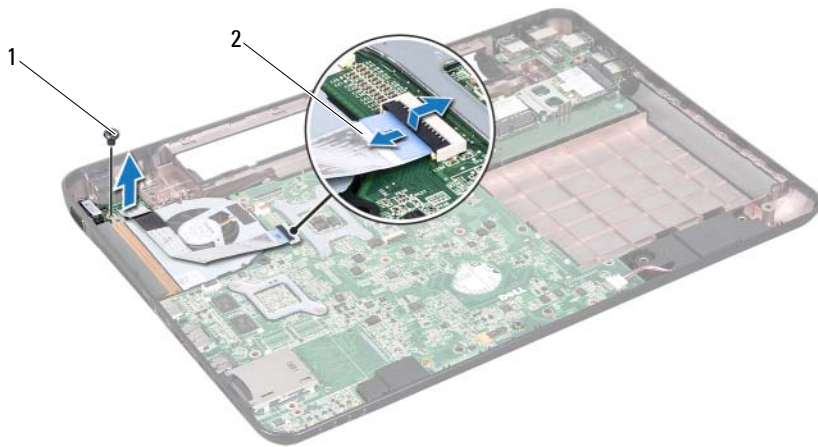

- 1 screw 2 display cable

Replacing the VGA Connector Board





- 1 Follow the instructions in "Before You Begin" on page 9.
- 2 Align the connector on the VGA connector board with the slot on the computer base.
- 3 Connect the display cable to the connector on the system board.
- 4 Replace the screw that secures the VGA connector board to the computer base.
- 5 Replace the hinge cover (see "Replacing the Hinge Cover" on page 71).
- 6 Replace the display assembly (see "Replacing the Display Assembly" on page 56).
- 7 Replace the palm-rest assembly (see "Replacing the Palm-Rest Assembly" on page 35).
- 8 Replace the keyboard (see "Replacing the Keyboard" on page 29).

9 Replace the battery (see "Replacing the Battery" on page 16).



CAUTION: Before turning on the computer, replace all screws and ensure that no stray screws remain inside the computer. Failure to do so may result in damage to the computer.

System Board

-  **WARNING:** Before working inside your computer, read the safety information that shipped with your computer. For additional safety best practices information, see the Regulatory Compliance Homepage at dell.com/regulatory_compliance.
-  **CAUTION:** Only a certified service technician should perform repairs on your computer. Damage due to servicing that is not authorized by Dell is not covered by your warranty.
-  **CAUTION:** To avoid electrostatic discharge, ground yourself by using a wrist grounding strap or by periodically touching an unpainted metal surface (such as a connector on your computer).
-  **CAUTION:** To help prevent damage to the system board, remove the main battery (see "Removing the Battery" on page 15) before working inside the computer.
-  **CAUTION:** Handle components and cards by their edges, and avoid touching pins and contacts.

Removing the System Board

- 1 Follow the instructions in "Before You Begin" on page 9.
- 2 Press and eject any installed cards or blanks from the 8-in-1 media card reader.
- 3 Remove the battery (see "Removing the Battery" on page 15).
- 4 Remove the module cover (see "Removing the Module Cover" on page 17).
- 5 Remove the memory module(s) (see "Removing the Memory Module(s)" on page 23).
- 6 Follow the instructions from step 4 to step 5 in "Removing the Optical Drive" on page 19.
- 7 Disconnect the AC-adaptor connector cable from the connector on the system board.



1 AC-adaptor connector cable

- 8 Remove the keyboard (see "Removing the Keyboard" on page 27).
- 9 Remove the palm-rest assembly (see "Removing the Palm-Rest Assembly" on page 31).
- 10 Remove the thermal fan (see "Removing the Thermal Fan" on page 49).
- 11 Loosen the display cable grounding screw.
- 12 Disconnect the display cable and speakers cable from the connectors on the system board.
- 13 Remove the five screws that secure the system board to the computer base.

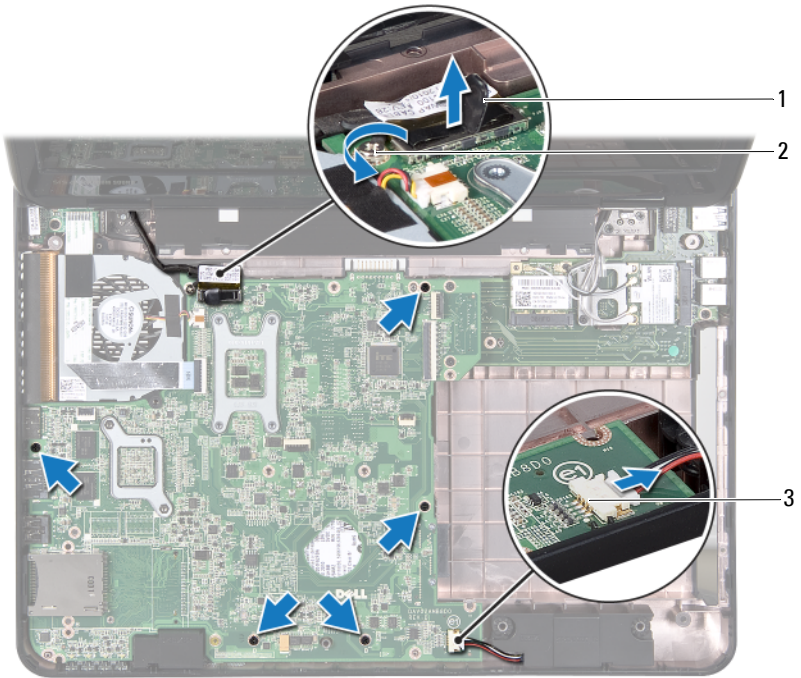

- 1 display cable connector
- 2 display cable grounding screw
- 3 speakers cable connector

14 Lift the system board assembly to disconnect the connector on the system board from the connector on the I/O board.



1 system board

- 15 Turn the system board over.
- 16 Remove the coin-cell battery (see "Removing the Coin-Cell Battery" on page 87).
- 17 Follow the instructions from step 3 to step 5 in "Removing the Hard-Drive Assembly" on page 95.
- 18 Remove the thermal cooling assembly (see "Removing the Thermal Cooling Assembly" on page 89).
- 19 Remove the processor module (see "Removing the Processor Module" on page 91).

Replacing the System Board

- 1 Follow the instructions in "Before You Begin" on page 9.
- 2 Replace the processor module (see "Replacing the Processor Module" on page 92).
- 3 Replace the thermal cooling assembly (see "Replacing the Thermal Cooling Assembly" on page 90).
- 4 Follow the instructions from step 5 to step 7 in "Replacing the Hard-Drive Assembly" on page 97.
- 5 Replace the coin-cell battery (see "Replacing the Coin-Cell Battery" on page 88).
- 6 Turn the system board over.
- 7 Align the connectors on the system board with the slots on the computer base and place it in position.
- 8 Gently press the system board to connect the connector on the system board to the connector on the I/O board.
- 9 Replace the five screws that secure the system board to the computer base.
- 10 Connect the display cable and speakers cable to the connectors on the system board.
- 11 Tighten the display cable grounding screw.
- 12 Replace the thermal fan (see "Replacing the Thermal Fan" on page 50).
- 13 Replace the palm-rest assembly (see "Replacing the Palm-Rest Assembly" on page 35).
- 14 Replace the keyboard (see "Replacing the Keyboard" on page 29).
- 15 Connect the AC-adaptor connector cable to the connector on the system board.
- 16 Follow the instructions from step 4 to step 5 in "Replacing the Optical Drive" on page 21.
- 17 Replace the memory module(s) (see "Replacing the Memory Module(s)" on page 24).
- 18 Replace the module cover (see "Replacing the Module Cover" on page 18).
- 19 Replace the battery (see "Replacing the Battery" on page 16).

20 Replace any cards or blanks removed from the 8-in-1 media card reader.



CAUTION: Before turning on the computer, replace all screws and ensure that no stray screws remain inside the computer. Failure to do so may result in damage to the computer.

21 Turn on the computer.







NOTE: After you have replaced the system board, enter the computer Service Tag in the BIOS of the replacement system board.

22 Enter the service tag (see "Entering the Service Tag in the BIOS" on page 82).

Entering the Service Tag in the BIOS

- 1 Ensure that the AC adapter is plugged in and that the main battery is installed properly.
- 2 Turn on the computer.
- 3 Press <F2> as soon as you see the Dell logo to enter the system setup program.
- 4 Navigate to the security tab and enter the service tag in the **Set Service Tag** field.

Speakers

-  **WARNING:** Before working inside your computer, read the safety information that shipped with your computer. For additional safety best practices information, see the Regulatory Compliance Homepage at dell.com/regulatory_compliance.
-  **CAUTION:** To avoid electrostatic discharge, ground yourself by using a wrist grounding strap or by periodically touching an unpainted metal surface (such as a connector on your computer).
-  **CAUTION:** Only a certified service technician should perform repairs on your computer. Damage due to servicing that is not authorized by Dell is not covered by your warranty.
-  **CAUTION:** To help prevent damage to the system board, remove the main battery (see "Removing the Battery" on page 15) before working inside the computer.

Removing the Speakers

- 1 Follow the instructions in "Before You Begin" on page 9.
- 2 Follow the instructions from step 2 to step 14 in "Removing the System Board" on page 77.
- 3 Note the speakers cable routing and lift the left and right speakers along with the its cable from the computer base.



- 1 speakers (2) 2 speakers cable





Replacing the Speakers

- 1 Follow the instructions in "Before You Begin" on page 9.
- 2 Place the speakers on the computer base and route the speakers cable through the routing guides.
- 3 Follow the instructions from step 7 to step 20 in "Replacing the System Board" on page 81.



CAUTION: Before turning on the computer, replace all screws and ensure that no stray screws remain inside the computer. Failure to do so may result in damage to the computer.

Coin-Cell Battery

-  **WARNING:** Before working inside your computer, read the safety information that shipped with your computer. For additional safety best practices information, see the Regulatory Compliance Homepage at dell.com/regulatory_compliance.
-  **CAUTION:** Only a certified service technician should perform repairs on your computer. Damage due to servicing that is not authorized by Dell is not covered by your warranty.
-  **CAUTION:** To avoid electrostatic discharge, ground yourself by using a wrist grounding strap or by periodically touching an unpainted metal surface (such as a connector on your computer).
-  **CAUTION:** To help prevent damage to the system board, remove the main battery (see "Removing the Battery" on page 15) before working inside the computer.

Removing the Coin-Cell Battery

- 1 Follow the instructions in "Before You Begin" on page 9.
- 2 Follow the instructions from step 2 to step 15 in "Removing the System Board" on page 77.
- 3 Use a plastic scribe and gently pry the coin-cell out of the battery socket on the system board.
- 4 Lift the coin-cell battery out of the system-board socket.

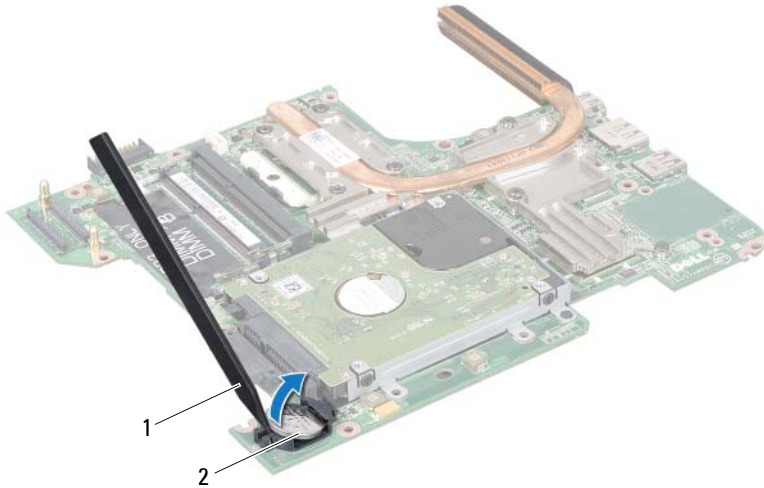

1 plastic scribe 2 coin-cell battery





Replacing the Coin-Cell Battery

- 1 Follow the instructions in "Before You Begin" on page 9.
- 2 Hold the coin-cell battery with the positive side up.
- 3 Slide the coin-cell battery into the slot and gently press until it snaps in place.
- 4 Follow the instructions from step 6 to step 20 in "Replacing the System Board" on page 81.



CAUTION: Before turning on the computer, replace all screws and ensure that no stray screws remain inside the computer. Failure to do so may result in damage to the computer.

Thermal Cooling Assembly

-  **WARNING:** Before working inside your computer, read the safety information that shipped with your computer. For additional safety best practices information, see the Regulatory Compliance Homepage at dell.com/regulatory_compliance.
-  **WARNING:** If you remove the thermal cooling assembly from the computer when the heat sink is hot, *do not touch* the metal housing of the thermal cooling assembly.
-  **CAUTION:** Only a certified service technician should perform repairs on your computer. Damage due to servicing that is not authorized by Dell is not covered by your warranty.
-  **CAUTION:** To avoid electrostatic discharge, ground yourself by using a wrist grounding strap or by periodically touching an unpainted metal surface (such as a connector on your computer).
-  **CAUTION:** To help prevent damage to the system board, remove the main battery (see "Removing the Battery" on page 15) before working inside the computer.

Removing the Thermal Cooling Assembly

- 1 Follow the instructions in "Before You Begin" on page 9.
- 2 Remove the system board (see "Removing the System Board" on page 77).
- 3 Turn the system board over and keep it on a clean surface.
- 4 In sequential order (indicated on the thermal cooling assembly), loosen the seven captive screws that secure the thermal cooling assembly to the system board.
- 5 Lift the thermal cooling assembly off the system board.

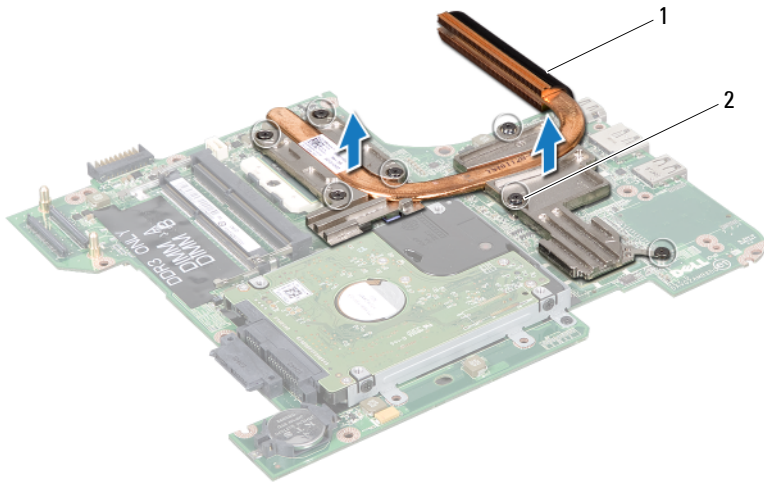

- 1 thermal cooling assembly 2 captive screws (7)





Replacing the Thermal Cooling Assembly

 **NOTE:** The original thermal grease can be reused if the original processor and heat sink are reinstalled together. If either the processor or the heat sink is replaced, use the thermal pad provided in the kit to ensure that thermal conductivity is achieved.



- 1 Follow the instructions in "Before You Begin" on page 9.
- 2 Place the thermal cooling assembly on the system board.
- 3 Align the seven captive screws on the thermal cooling assembly with the screw holes on the system board and tighten the screws in sequential order (indicated on the thermal cooling assembly).
- 4 Replace the system board (see "Replacing the System Board" on page 81).

 **CAUTION:** Before turning on the computer, replace all screws and ensure that no stray screws remain inside the computer. Failure to do so may result in damage to the computer.

Processor Module

-  **WARNING:** Before working inside your computer, read the safety information that shipped with your computer. For additional safety best practices information, see the Regulatory Compliance Homepage at dell.com/regulatory_compliance.
-  **CAUTION:** Only a certified service technician should perform repairs on your computer. Damage due to servicing that is not authorized by Dell is not covered by your warranty.
-  **CAUTION:** To avoid electrostatic discharge, ground yourself by using a wrist grounding strap or by periodically touching an unpainted metal surface (such as a connector on your computer).
-  **CAUTION:** To help prevent damage to the system board, remove the main battery (see "Removing the Battery" on page 15) before working inside the computer.
-  **CAUTION:** Handle components and cards by their edges, and avoid touching pins and contacts.

Removing the Processor Module

- 1 Follow the instructions in "Before You Begin" on page 9.
 - 2 Follow the instructions from step 2 to step 15 in "Removing the System Board" on page 77.
 - 3 Remove the thermal cooling assembly (see "Removing the Thermal Cooling Assembly" on page 89).
 - 4 To loosen the ZIF socket, use a small, flat-blade screwdriver and rotate the ZIF-socket cam screw counterclockwise until it comes to the cam stop.
-  **CAUTION:** To ensure maximum cooling for the processor, do not touch the heat transfer areas on the processor thermal-cooling assembly. The oils in your skin can reduce the heat transfer capability of the thermal pads.
 -  **CAUTION:** When removing the processor module, pull the module straight up. Be careful not to bend the pins on the processor module.
- 5 Lift the processor module from the ZIF socket.

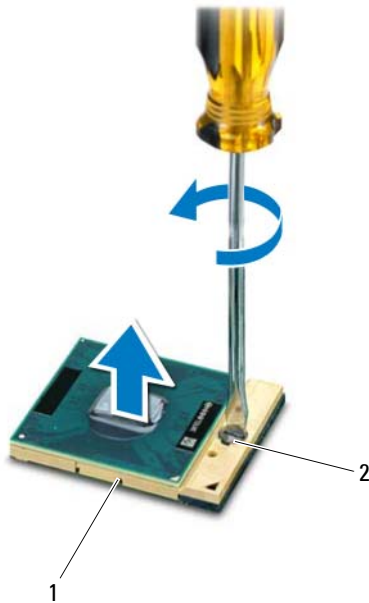

- 1 ZIF socket 2 ZIF-socket cam screw

Replacing the Processor Module

- 1 Follow the instructions in "Before You Begin" on page 9.

 **NOTE:** If a new processor is installed, you will receive a new thermal-cooling assembly, which will include an affixed thermal pad, or you will receive a new thermal pad along with documentation to illustrate proper installation.

- 2 Align the pin-1 corner of the processor module with the pin-1 corner of the ZIF socket, then insert the processor module.

 **NOTE:** The pin-1 corner of the processor module has a triangle that aligns with the triangle on the pin-1 corner of the ZIF socket.

When the processor module is properly seated, all four corners are aligned at the same height. If one or more corners of the module are higher than the others, the module is not seated properly.

 **CAUTION: To avoid damage to the processor, hold the screwdriver perpendicular to the processor when turning the cam screw.**

- 3** Tighten the ZIF socket by turning the cam screw clockwise to secure the processor module to the system board.
- 4** Replace the thermal cooling assembly (see "Replacing the Thermal Cooling Assembly" on page 90).
- 5** Follow the instructions from step 6 to step 20 in "Replacing the System Board" on page 81.

 **CAUTION: Before turning on the computer, replace all screws and ensure that no stray screws remain inside the computer. Failure to do so may result in damage to the computer.**

Hard-Drive Assembly

 **WARNING:** Before working inside your computer, read the safety information that shipped with your computer. For additional safety best practices information, see the Regulatory Compliance Homepage at dell.com/regulatory_compliance.

 **WARNING:** If you remove the hard drive from the computer when the drive is hot, *do not touch* the metal housing of the hard drive.

 **CAUTION:** Only a certified service technician should perform repairs on your computer. Damage due to servicing that is not authorized by Dell is not covered by your warranty.

 **CAUTION:** To avoid electrostatic discharge, ground yourself by using a wrist grounding strap or by periodically touching an unpainted metal surface (such as a connector on your computer).

 **CAUTION:** To help prevent damage to the system board, remove the main battery (see "Removing the Battery" on page 15) before working inside the computer.

 **CAUTION:** To prevent data loss, turn off your computer (see "Turning Off Your Computer" on page 9) before removing the hard-drive assembly. Do not remove the hard drive while the computer is On or in Sleep state.

 **CAUTION:** Hard drives are extremely fragile. Exercise care when handling the hard drive.

 **NOTE:** Dell does not guarantee compatibility or provide support for hard drives from sources other than Dell.

 **NOTE:** If you are installing a hard drive from a source other than Dell, you need to install an operating system, drivers, and utilities on the new hard drive.

Removing the Hard-Drive Assembly

- 1 Follow the instructions in "Before You Begin" on page 9.
- 2 Follow the instructions from step 2 to step 15 in "Removing the System Board" on page 77.
- 3 Remove the screw that secures the hard-drive assembly to the system board.

- 4 Slide the hard-drive assembly in the direction shown in the illustration to disconnect it from the connector on the system board.
- 5 Lift the hard-drive assembly off the system board.

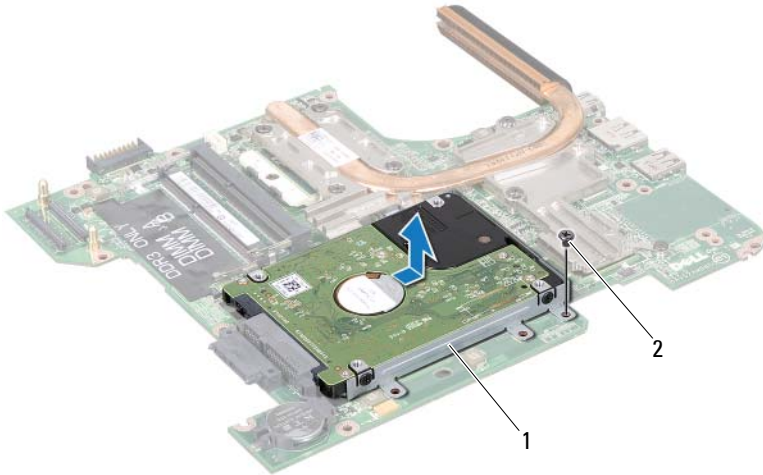

1 hard-drive assembly 2 screw

- 6 Remove the four screws that secure the hard-drive bracket to the hard drive.
- 7 Lift the hard drive away from the hard-drive bracket.



- 1 screws (4)
- 2 hard-drive bracket
- 3 hard drive

Replacing the Hard-Drive Assembly





- 1 Follow the instructions in "Before You Begin" on page 9.
- 2 Remove the new hard drive from its packaging.
Save the original packaging for storing or shipping the hard drive.
- 3 Place the hard drive in the hard-drive bracket.
- 4 Replace the four screws that secure the hard-drive bracket to the hard drive.
- 5 Place the hard-drive assembly on the system board.
- 6 Slide the hard-drive assembly to connect it to the connector on the system board.
- 7 Replace the screw that secures the hard-drive assembly to the system board.

- 8 Follow the instructions from step 6 to step 20 in "Replacing the System Board" on page 81.



CAUTION: Before turning on the computer, replace all screws and ensure that no stray screws remain inside the computer. Failure to do so may result in damage to the computer.

I/O Board

-  **WARNING:** Before working inside your computer, read the safety information that shipped with your computer. For additional safety best practices information, see the Regulatory Compliance Homepage at dell.com/regulatory_compliance.
-  **CAUTION:** Only a certified service technician should perform repairs on your computer. Damage due to servicing that is not authorized by Dell is not covered by your warranty.
-  **CAUTION:** To avoid electrostatic discharge, ground yourself by using a wrist grounding strap or by periodically touching an unpainted metal surface (such as a connector on your computer).
-  **CAUTION:** To help prevent damage to the system board, remove the main battery (see "Removing the Battery" on page 15) before working inside the computer.

Removing the I/O Board

- 1 Follow the instructions in "Before You Begin" on page 9.
- 2 Follow the instructions from step 2 to step 14 in "Removing the System Board" on page 77.
- 3 Remove the Mini-Card(s) (see "Removing the Mini-Card(s)" on page 45).
- 4 Remove the display assembly (see "Removing the Display Assembly" on page 53).
- 5 Remove the hinge cover (see "Removing the Hinge Cover" on page 69).
- 6 Remove the two screws that secure the I/O board to the computer base.
- 7 Lift the I/O board off the computer base.

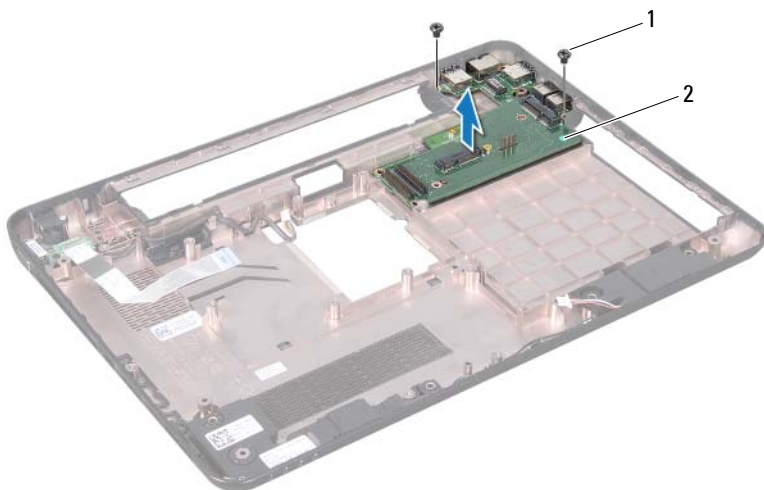

1 screws (2) 2 I/O board





Replacing the I/O Board

- 1 Follow the instructions in "Before You Begin" on page 9.
- 2 Align the connectors on the I/O board into the slots on the computer base.
- 3 Replace the two screws that secure the I/O board to the computer base.
- 4 Replace the hinge cover (see "Replacing the Hinge Cover" on page 71).
- 5 Replace the display assembly (see "Replacing the Display Assembly" on page 56).
- 6 Replace the Mini-Card(s) (see "Replacing the Mini-Card(s)" on page 47).
- 7 Follow the instructions from step 7 to step 20 in "Replacing the System Board" on page 81.



CAUTION: Before turning on the computer, replace all screws and ensure that no stray screws remain inside the computer. Failure to do so may result in damage to the computer.

AC-Adapter Connector

-  **WARNING:** Before working inside your computer, read the safety information that shipped with your computer. For additional safety best practices information, see the Regulatory Compliance Homepage at dell.com/regulatory_compliance.
-  **CAUTION:** Only a certified service technician should perform repairs on your computer. Damage due to servicing that is not authorized by Dell is not covered by your warranty.
-  **CAUTION:** To avoid electrostatic discharge, ground yourself by using a wrist grounding strap or by periodically touching an unpainted metal surface (such as a connector on your computer).
-  **CAUTION:** To help prevent damage to the system board, remove the main battery (see "Removing the Battery" on page 15) before working inside the computer.

Removing the AC-Adapter Connector

- 1 Follow the instructions in "Before You Begin" on page 9.
- 2 Follow the instructions from step 2 to step 14 in "Removing the System Board" on page 77.
- 3 Remove the display assembly (see "Removing the Display Assembly" on page 53).
- 4 Remove the hinge cover (see "Removing the Hinge Cover" on page 69).
- 5 Remove the VGA connector board (see "Removing the VGA Connector Board" on page 73).
- 6 Note the AC-adapter connector cable routing and remove the cable from the routing guides.
- 7 Remove the screw that secures the AC-adapter connector to the computer base.
- 8 Lift the AC-adapter connector off the computer base.

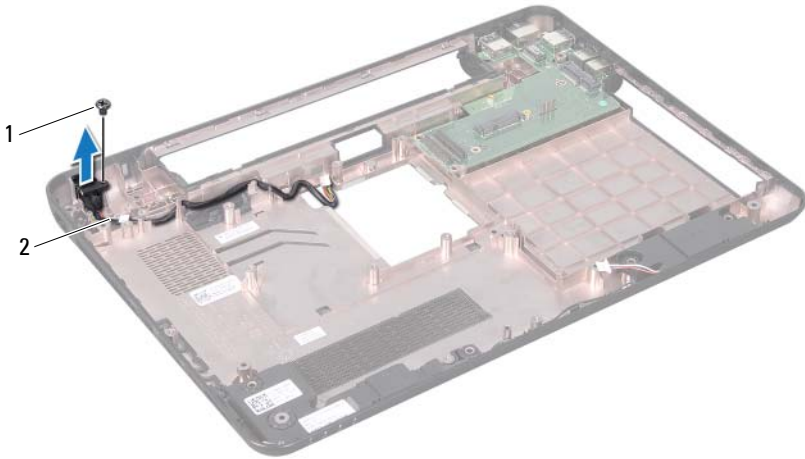

- 1 screw 2 AC-adapter connector cable

Replacing the AC-Adapter Connector

- 1 Follow the instructions in "Before You Begin" on page 9.
- 2 Place the AC-adapter connector on the computer base.
- 3 Replace the screw that secures the AC-adapter connector to the computer base.
- 4 Route the AC-adapter connector cable through the routing guides.
- 5 Replace the VGA connector board (see "Replacing the VGA Connector Board" on page 74).
- 6 Replace the hinge cover (see "Replacing the Hinge Cover" on page 71).
- 7 Replace the display assembly (see "Replacing the Display Assembly" on page 56).
- 8 Follow the instructions from step 7 to step 20 in "Replacing the System Board" on page 81.



CAUTION: Before turning on the computer, replace all screws and ensure that no stray screws remain inside the computer. Failure to do so may result in damage to the computer.

Flashing the BIOS

The BIOS may require flashing when an update is available or when replacing the system board. To flash the BIOS:

- 1 Turn on the computer.
- 2 Go to support.dell.com/support/downloads.
- 3 Locate the BIOS update file for your computer:



NOTE: The Service Tag for your computer is located on a label at the bottom of your computer.

If you have your computer's Service Tag:

- a Click **Enter a Tag**.
- b Enter your computer's Service Tag in the **Enter a service tag:** field, click **Go**, and proceed to step 4.

If you do not have your computer's Service Tag:

- a Click **Select Model**.
- b Select the type of product in the **Select Your Product Family** list.
- c Select the product brand in the **Select Your Product Line** list.
- d Select the product model number in the **Select Your Product Model** list.



NOTE: If you have selected a different model and want to start over again, click **Start Over** on the top right of the menu.

- e Click **Confirm**.
- 4 A list of results appear on the screen. Click **BIOS**.
- 5 Click **Download Now** to download the latest BIOS file. The **File Download** window appears.
- 6 Click **Save** to save the file on your desktop. The file downloads to your desktop.
- 7 Click **Close** if the **Download Complete** window appears. The file icon appears on your desktop and is titled the same as the downloaded BIOS update file.

- 8 Double-click the file icon on the desktop and follow the instructions on the screen.