

Simplified Service Manual–U4919DWB

Version: 01

Date:2021/02/04

Content Index

1. General Safety Instructions	3
1.1 SAFETY: General Safety	3
1.2 SAFETY: General Power Safety	5
2. Exploded view diagram with list of items	6
3. Wiring connectivity diagram	7
4. Disassembly and Assembly Procedures	8
4.1 Disassembly SOP	8
4.2 Assembly SOP	12
5. Trouble shooting instructions	16

1. General Safety Instructions

Use the following safety guidelines to help ensure your own personal safety and to help protect your equipment and working environment from potential damage.

NOTE: In this section, equipment refers to monitors.

IMPORTANT NOTICE FOR USE IN HEALTHCARE ENVIRONMENTS:

Dell products are not medical devices and are not listed under UL or IEC 60601 (or equivalent). As a result, they must not be used within 6 feet of a patient or in a manner that directly or indirectly contacts a patient

1.1 SAFETY: General Safety

WARNING: To prevent the spread of fire, keep candles or other open flames away from this product at all times.

When setting up the equipment for use:

- Place the equipment on a hard, level surface. Leave 10.2 cm (4 in) minimum of clearance on all vented sides of the computer to permit the airflow required for proper ventilation.
- Restricting airflow can damage the computer or cause a fire.
- Do not stack equipment or place equipment so close together that it is subject to recirculated or preheated air.
- NOTE: Review the weight limits referenced in your computer documentation before placing a monitor or other devices on top of your computer.
- Ensure that nothing rests on your equipment's cables and that the cables are not located where they can be stepped on or tripped over.
- Ensure that all cables are connected to the appropriate connectors. Some connectors have a similar appearance and may be easily confused (for example, do not plug a telephone cable into the network connector).
- Do not place your equipment in a closed-in wall unit or on a bed, sofa, or rug.
- Keep your device away from radiators and heat sources.
- Keep your equipment away from extremely hot or cold temperatures to ensure that it is used within the specified operating range.
- Do not push any objects into the air vents or openings of your equipment. Doing so can cause fire or electric shock by shorting out interior components.
- Avoid placing loose papers underneath your device. Do not place your device in a closed-in wall unit, or on a soft, fabric surface such as a bed, sofa, carpet, or a rug.

When operating your equipment:

- Do not use your equipment in a wet environment, for example, near a bath tub, sink, or swimming pool or in a wet basement.
- Do not use AC powered equipment during an electrical storm. Battery powered devices may be used if all cables have been disconnected.
- Do not spill food or liquids on your equipment.
- Before you clean your equipment, disconnect it from the electrical outlet. Clean your device with a soft cloth dampened with water. Do not use liquids or aerosol cleaners, which may contain flammable substances.
- Clean the monitor display with a soft, clean cloth and water. Apply the water to the cloth, then stroke the cloth across the display in one direction, moving from the top of the display to the bottom. Remove moisture from the display quickly and keep the display dry.
- Long-term exposure to moisture can damage the display. Do not use a commercial window cleaner to clean your display.
- If your equipment does not operate normally - in particular, if there are any unusual sounds or smells coming from it - unplug it immediately and contact an authorized dealer or service center.

Protecting Against Electrostatic Discharge

Electrostatic discharge (ESD) events can harm electronic components inside your equipment. Under certain conditions, ESD may build up on your body or an object, such as a peripheral, and then discharge into another object, such as your computer. To prevent ESD damage, you should discharge static electricity from your body before you interact with any of your equipment's internal electronic components, such as a memory module. You can protect against ESD by touching a metal grounded object (such as an unpainted metal surface on your computer's I/O panel) before you interact with anything electronic. When connecting a peripheral (including handheld digital assistants) to your equipment, you should always ground both yourself and the peripheral before connecting it. In addition, as you work inside the equipment, periodically discharge any static charge your body may have accumulated.

You can also take the following steps to prevent damage from electrostatic discharge:

- When unpacking a static-sensitive component from its shipping carton, do not remove the component from the antistatic packing material until you are ready to install the component. Just before unwrapping the antistatic package, be sure to discharge static electricity from your body.
- When transporting a sensitive component, first place it in an antistatic container or packaging.
- Handle all electrostatic sensitive components in a static-safe area. If possible, use antistatic floor pads and work bench pads.

1.2 SAFETY: General Power Safety

Observe the following guidelines when connecting your equipment to a power source:

- Check the voltage rating before you connect the equipment to an electrical outlet to ensure that the required voltage and frequency match the available power source.
- Do not plug the equipment power cables into an electrical outlet if the power cable is damaged
- Norway and Sweden: If this product is provided with a 3-prong power cable, connect the power cable to a grounded electrical outlet only.
- If you use an extension power cable, ensure that the total ampere rating of the products plugged in to the extension power cable does not exceed the ampere rating of the extension cable.
- If you must use an extension cable or power strip, ensure the extension cable or power strip is connected to a wall power outlet and not to another extension cable or power strip. The extension cable or power strip must be designed for grounded plugs and plugged into a grounded wall outlet.
- If you are using a multiple-outlet power strip, use caution when plugging the power cable into the power strip. Some power strips may allow you to insert a plug incorrectly. Incorrect insertion of the power plug could result in permanent damage to your equipment, as well as risk of electric shock and/or fire. Ensure that the ground prong of the power plug is inserted into the mating ground contact of the power strip.
- Be sure to grasp the plug, not the cable, when disconnecting equipment from an electric socket.

If your equipment uses an AC adapter:

- Use only the Dell provided AC adapter approved for use with this device. Use of another AC adapter may cause a fire or explosion.
- NOTE: Refer to your system rating label for information on the proper adapter model approved for use with your device.
- Place the AC adapter in a ventilated area, such as a desk top or on the floor, when you use it to run the computer or to charge the battery. Do not cover the AC adapter with papers or other items that will reduce cooling; also, do not use the AC adapter inside a carrying case.
- The AC adapter may become hot during normal operation of your computer. Use care when handling the adapter during or immediately after operation.
- It is recommended that you lay the adapter on the floor or desk so that the green light is visible. This will alert you if the adapter should accidentally go off due to external effects. If for any reason the green light goes off, disconnect the AC power cord from the wall for a period of ten seconds, and then reconnect the power cord.
- Japan Only: Use only the Dell-provided AC power cable with the AC adapter. Use of any other power cable may damage the device or AC adapter or may present risk of fire or electric shock.

2. Exploded view diagram with list of items

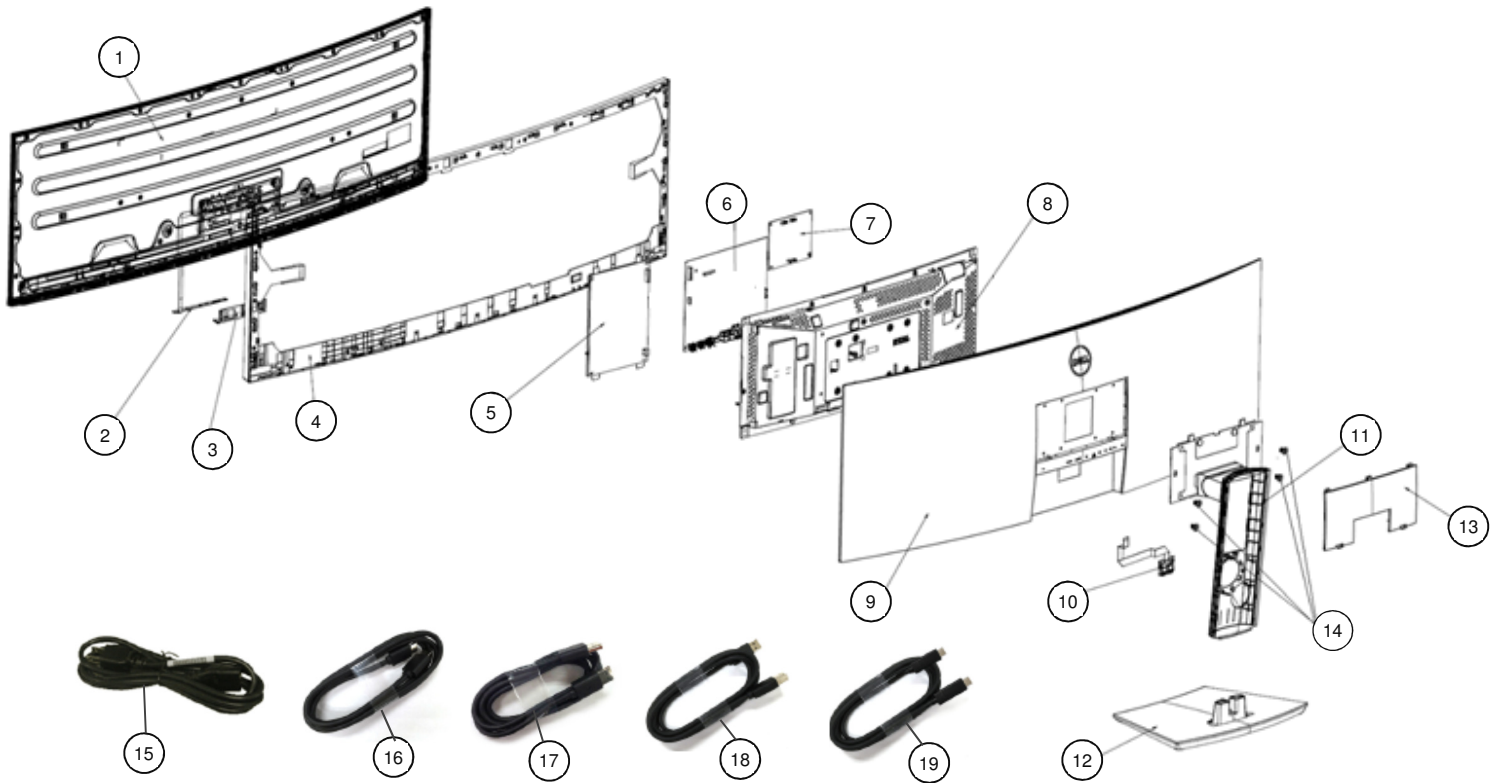

Item	Description	Q'ty
1	Panel	1
2	PCBA CTRL BD	1
3	BTN PWR	1
4	MID-FRAME	1
5	PCBA SPS BD	1
6	PCBA I/F BD	1
7	PCBA LED DRV BD	1
8	ASSY SHD MAIN	1
9	ASSY RC	1
10	PCBA USB BD	1
11	ASSY CLMN	1
12	ASSY BASE	1
13	ASSY CVR VESA	1
14	Screw x 4 for assembling stand to monitor head	1
15	Power Cable	1
16	HDMI Cable	1
17	DP Cable	1
18	USB 3.0 Upstream Cable	1
19	USB Type-C Cable	1

3. Wiring connectivity diagram

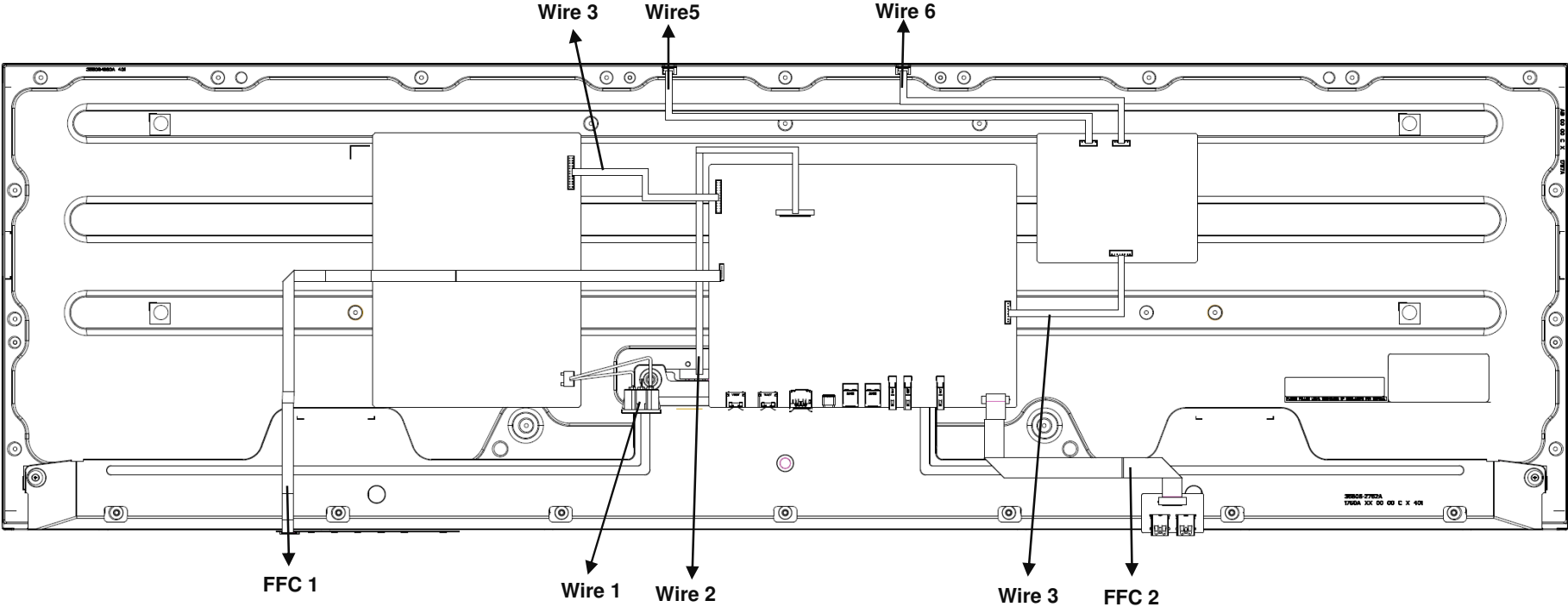



4. Disassembly and Assembly Procedures

4.1 Disassembly SOP

Preparation before disassemble

1. Clean the room for disassemble
2. Identify the area for monitor
3. Check the position that the monitors be placed and the quantity of the monitor; prepare the area for material flow; according to the actual condition plan the disassemble layout
4. Prepare the implement, equipment, material as bellow:
 - 1) Working table
 - 2) Philips-head screwdriver
 - 3) Glove
 - 4) Cleaning cloth
 - 5) ESD protection
 - 6) U4919DW Curve Sponge Jig
 - 7) Bar scraper

Item	Picture	Operation	Tool	Notes
1		<p>To remove the stand:</p> <ol style="list-style-type: none"> 1. Place monitor on U4919DW curve sponge jig 2. Press and lift the cover latch to release and remove the cover 3. Use a Phillips crosshead screwdriver to remove the four screws securing the stand 4. Lift the stand up and away from the monitor 	<ol style="list-style-type: none"> 1. U4919DW Curve Sponge Jig 2. Phillips crosshead screwdriver (Screw Torque: 8~10kgf) 	<p>Panel and whole monitor head must be placed on U4919DW curve sponge jig to avoid panel damage.</p> <p>It is not allowed to place the front side of panel and monitor head on a flat surface</p>

<p>2</p>		<ol style="list-style-type: none"> 1. Unlock 4 screws on Rear Cover 2. Disassemble Rear Cover from Middle Frame (Sequence: 2 corner of top side → the middle of top side → left & right sides → the 2 corner of bottom side → the middle of bottom side) 	<p>Philips-head screwdriver</p> <p>(Screw Torque: 11±1kgf)</p>	
<p>3</p>		<ol style="list-style-type: none"> 1. Remove USB SIDE BD FFC cable from I/F BD to take off Rear Cover 		

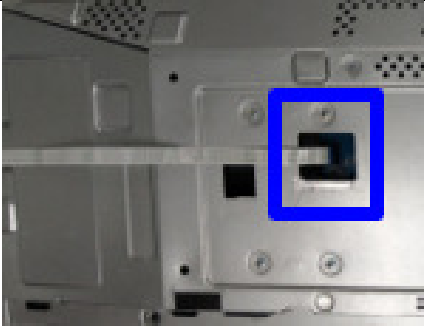
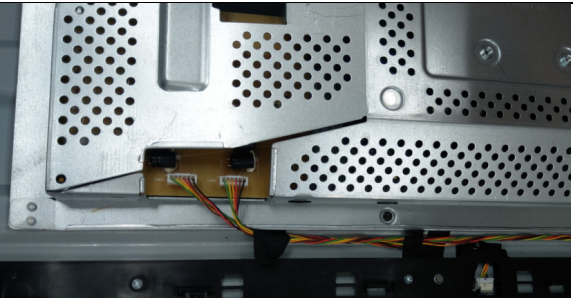
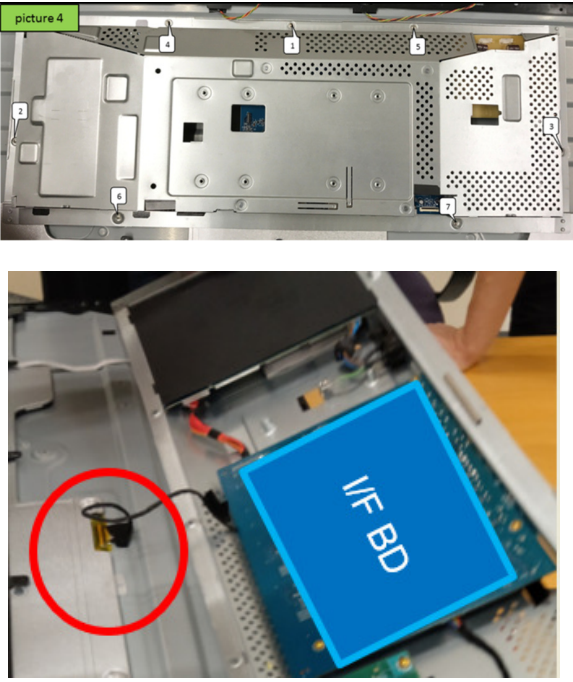
4		<ol style="list-style-type: none"> 1. Tear off Al tape from Main Shielding (See blue mark) 2. Pull out Control BD cable from I/F BD 	<p>Philips-head screwdriver</p> <p>Torsion of BKT screw: 4.5±0.5KG</p>	
5		<ol style="list-style-type: none"> 1. Pull out lamp wire from PCBA 		
6		<ol style="list-style-type: none"> 1. Unlock 7 screws on Main Shielding 2. Disassemble EDP cable from panel to take off Main Shielding 	<p>Philips-head screwdriver</p> <p>Torsion of Main Shielding screw: 4.5±0.5KG</p>	

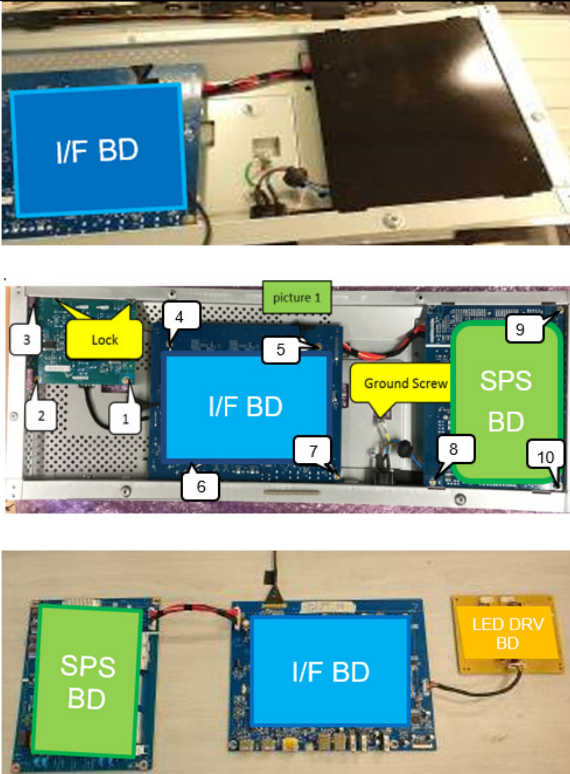
<p>7</p>		<ol style="list-style-type: none"> 1. Take off safety Mylar from Power BD 2. Unlock 10 PCBA screws & 1 ground screw 3. Disassemble PCBA from Main Shielding and pull off all wires from PCBA 	<p>Philips-head screwdriver</p> <p>Torsion of PCB & ground screw: 8.5~9.5kgf</p>	
----------	--	---	--	--

4.2 Assembly SOP

Preparation before assemble

1. Clean the room for work
2. Identify the area for material
3. Prepare the implement, equipment, material as bellow:
 - 1) Working table
 - 2) Philips-head screwdriver
 - 3) Glove
 - 4) Cleaning cloth
 - 5) ESD protection
 - 6) U4919DW Curve Sponge Jig

Item	Picture	Operation	Tools	Notes
1	<p>picture 1</p> <p>picture 2</p> <p>picture 3</p> <p>picture 4</p> <p>I/F BD</p> <p>P/B wire</p> <p>diver board wire</p> <p>LED DRV BD</p> <p>adhesive</p>	<ol style="list-style-type: none"> 1. Assemble AC wire and Power BD to main shielding 2. Plug EDP wire into I/FBD Paste yellow tape and adhesive tape 3. Plug Driver Board wire and Power BD wire into I/F BD and assemble I/FBD into Main Shielding 4. Plug Driver BD wire into I/F BD and assemble I/FBD into Main Shielding. Paste 1 adhesive tape to fix EDP wire 		

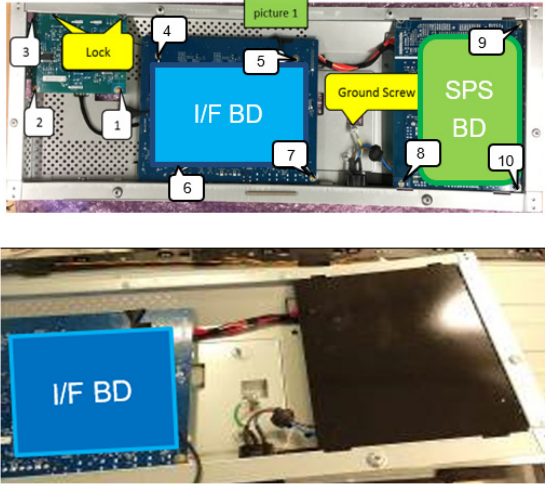
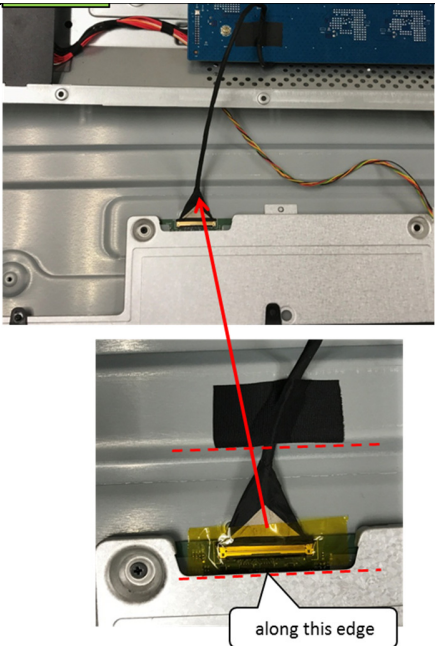
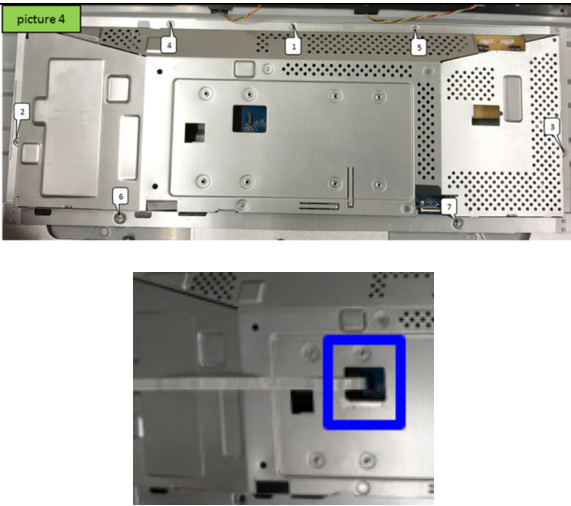
<p>2</p>		<ol style="list-style-type: none"> 1. Lock 10 PCBA screws and 1 ground screw 2. Assemble safety Mylar on Power BD 	<p>Philips-head screwdriver</p> <p>Torsion of PCB & Ground Screw: 8.5~9.5kg.f</p>	
<p>3</p>		<ol style="list-style-type: none"> 1. Plug EDP wire into panel and paste 1 yellow tape and 1 adhesive tape. 		
<p>4</p>		<ol style="list-style-type: none"> 1. Locate Main Shielding on panel and lock 7 screws 2. Paste Al tape on Main Shielding (See blue mark) 	<p>Philips-head screwdriver</p> <p>Torsion of Main Shielding screw: 4.5±0.5KG</p>	

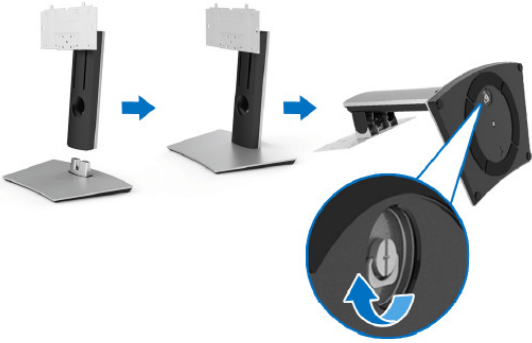
<p>5</p>		<ol style="list-style-type: none"> 1. Insert USB-side-BD FFC cable to I/F BD and assemble Rear Cover with Middle Frame 2. Press the Rear Cover (Sequence: the middle of bottom side→the 2 corner of bottom side→left & right sides→the middle of top side→2 corner of top side) 3. Lock 4 screws on Rear Cover 	<p>Philips-head screwdriver</p> <p>Torsion of RC screw: 11±1Kg</p>	
<p>6</p>		<p>To attach the monitor stand:</p> <ol style="list-style-type: none"> 1. Insert the stand base blocks fully into the stand slot 2. Lift the screw handle and turn the screw clockwise 3. After fully tightening the screw, fold the screw handle flat within the recess 		

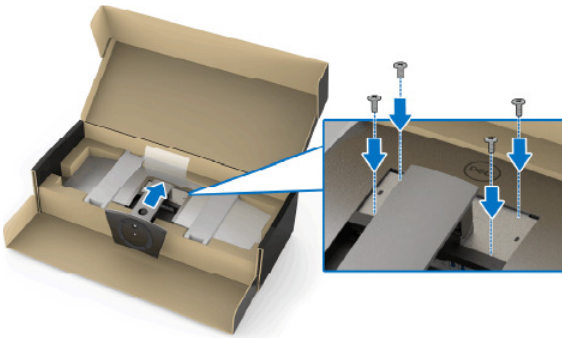
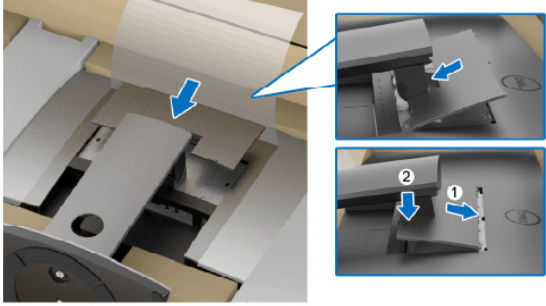
7		<p>Attach the stand assembly to the monitor</p> <ol style="list-style-type: none"> 1. Fit the two tabs on the upper part of the stand to the groove on the back of the monitor 2. Use a Phillips crosshead screwdriver to attach the four screws to secure the stand assembly to the monitor 		<p>NOTE: When attaching the stand assembly, tilt the stand base upwards and make sure that the stand base does not hit the surface</p>
8		<p>Attach the VESA cover to the monitor</p> <ol style="list-style-type: none"> 1. Insert the cover with the lower part downward. Do NOT attach the latch at this point 2. Tilt to fit the three tabs on the upper part of the cover to the groove of the back of the monitor 3. Press the cover down till the latch snaps into place 		

5. Trouble shooting instructions

Troubleshooting

⚠ WARNING: Before you begin any of the procedures in this section, follow the [Safety Instructions](#).

Self-Test

Your monitor provides a self-test feature that allows you to check whether your monitor is functioning properly. If your monitor and computer are properly connected but the monitor screen remains dark, run the monitor self-test by performing the following steps:

1. Turn off both your computer and the monitor.
2. Unplug the video cable from the back of the computer.
3. Turn on the monitor.

The floating dialog box should appear on-screen (against a black background), if the monitor cannot sense a video signal and is working correctly. While in self-test mode, the power LED remains white. Also, depending upon the selected input, the dialog shown below will continuously scroll through the screen.

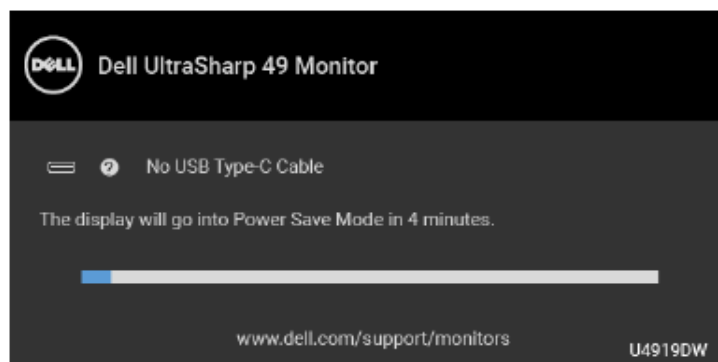

📌 NOTE: The message may be slightly different according to the connected input signal.

4. This box also appears during normal system operation, if the video cable becomes disconnected or damaged.
5. Turn Off your monitor and reconnect the video cable; then turn On both your computer and the monitor.

If your monitor screen remains blank after you use the previous procedure, check your video controller and computer, because your monitor is functioning properly.

Built-in Diagnostics

Your monitor has a built-in diagnostic tool that helps you determine if the screen abnormality you are experiencing is an inherent problem with your monitor, or with your computer and video card.

NOTE: You can run the built-in diagnostics only when the video cable is unplugged and the monitor is in *self-test mode*.

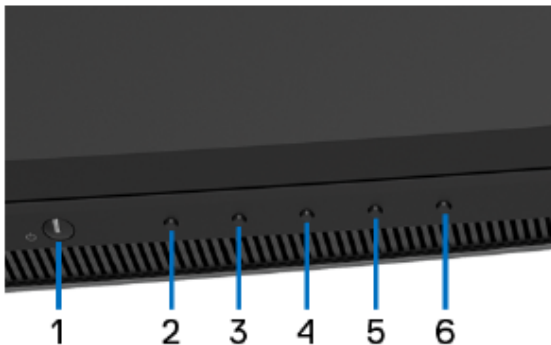

To run the built-in diagnostics:

1. Ensure that the screen is clean (no dust particles on the surface of the screen).
2. Press and hold **Button 6** for about 4 seconds until a pop menu appears.
3. Use **Button 3** or **Button 4** to select the diagnostic tool  and use **Button 5** to confirm. A gray test pattern appears at the beginning of the diagnostic program.
4. Carefully inspect the screen for abnormalities.
5. Press **Button 2** again to change the test patterns.
6. Repeat steps 4 and 5 to inspect the display in red, green, blue, black, white, and text screens.
7. Press **Button 2** to end the diagnostic program.

If you do not detect any screen abnormalities upon using the built-in diagnostic tool, the monitor is functioning properly. Check the video card and computer.

Always On USB Type-C Charging

The monitor allows you to charge your notebook or mobile devices through the USB Type-C cable even when the monitor is powered off. See [USB-C Charging](#) for more information. This feature is only available when the monitor firmware revision is M2B102 or later.

You may verify your current firmware revision in [Firmware](#). If this is not available, go to the Dell download support site for the latest application installer (**Monitor Firmware Update Utility.exe**) and refer to the Firmware Update Instruction User's Guide: www.dell.com/U4919DW

Common Problems

The following table contains general information about common monitor problems you might encounter and the possible solutions:

Common Symptoms	What You Experience	Possible Solutions
No Video/ Power LED off	No picture	<ul style="list-style-type: none">• Ensure that the video cable connecting the monitor and the computer is properly connected and secure.• Verify that the power outlet is functioning properly using any other electrical equipment.• Ensure that the power button is pressed fully.• Ensure that the correct input source is selected in the Input Source menu.
No Video/ Power LED on	No picture or no brightness	<ul style="list-style-type: none">• Increase brightness & contrast controls via OSD.• Perform monitor self-test feature check.• Check for bent or broken pins in the video cable connector.• Run the built-in diagnostics.• Ensure that the correct input source is selected in the Input Source menu.

Poor Focus	Picture is fuzzy, blurry, or ghosting	<ul style="list-style-type: none"> • Eliminate video extension cables. • Reset the monitor to factory settings. • Change the video resolution to the correct aspect ratio.
Shaky/Jittery Video	Wavy picture or fine movement	<ul style="list-style-type: none"> • Reset the monitor to factory settings. • Check environmental factors. • Relocate the monitor and test in another room.
Missing Pixels	LCD screen has spots	<ul style="list-style-type: none"> • Cycle power On-Off. • Pixel that is permanently Off is a natural defect that can occur in LCD technology. • For more information on Dell Monitor Quality and Pixel Policy, see Dell Support site at: http://www.dell.com/support/monitors.
Stuck-on Pixels	LCD screen has bright spots	<ul style="list-style-type: none"> • Cycle power On-Off. • Pixel that is permanently off is a natural defect that can occur in LCD technology. • For more information on Dell Monitor Quality and Pixel Policy, see Dell Support site at: http://www.dell.com/support/monitors.
Brightness Problems	Picture too dim or too bright	<ul style="list-style-type: none"> • Reset the monitor to factory settings. • Adjust brightness & contrast controls via OSD.
Geometric Distortion	Screen not centered correctly	<ul style="list-style-type: none"> • Reset the monitor to factory settings. • Adjust horizontal & vertical controls via OSD.

Horizontal/ Vertical Lines	Screen has one or more lines	<ul style="list-style-type: none"> Reset the monitor to factory settings. Perform monitor self-test feature check and determine if these lines are also in self-test mode. Check for bent or broken pins in the video cable connector. Run the built-in diagnostics.
Synchronization Problems	Screen is scrambled or appears torn	<ul style="list-style-type: none"> Reset the monitor to factory settings. Perform monitor self-test feature check to determine if the scrambled screen appears in self-test mode. Check for bent or broken pins in the video cable connector. Restart the computer in the <i>safe mode</i>.
Safety Related Issues	Visible signs of smoke or sparks	<ul style="list-style-type: none"> Do not perform any troubleshooting steps. Contact Dell immediately.
Intermittent Problems	Monitor malfunctions on & off	<ul style="list-style-type: none"> Ensure that the video cable connecting the monitor to the computer is connected properly and is secure. Reset the monitor to factory settings. Perform monitor self-test feature check to determine if the intermittent problem occurs in self-test mode.
Missing Color	Picture missing color	<ul style="list-style-type: none"> Perform monitor self-test feature check. Ensure that the video cable connecting the monitor to the computer is connected properly and is secure. Check for bent or broken pins in the video cable connector.

Wrong Color	Picture color not good	<ul style="list-style-type: none"> • Change the settings of the Preset Modes in the Color menu OSD depending on the application. • Adjust R/G/B value under Custom Color in Color menu OSD. • Change the Input Color Format to PC RGB or YPbPr in the Color menu OSD. • Run the built-in diagnostics.
Image retention from a static image left on the monitor for a long period of time	Faint shadow from the static image displayed appears on the screen	<ul style="list-style-type: none"> • Use the Power Management feature to turn off the monitor at all times when not in use (for more information, see Power Management Modes). • Alternatively, use a dynamically changing screensaver.
Image Ghosting	Fast moving images leave a trail of shadow images	<ul style="list-style-type: none"> • Change the Response Time in the Display menu.

Product Specific Problems

Specific Symptoms	What You Experience	Possible Solutions
Screen image is too small	Image is centered on screen, but does not fill entire viewing area	<ul style="list-style-type: none">• Check the Aspect Ratio setting in the Display menu OSD.• Reset the monitor to factory settings.
Cannot adjust the monitor with the buttons on the front panel	OSD does not appear on the screen	<ul style="list-style-type: none">• Turn Off the monitor, unplug the power cord, plug it back, and then turn On the monitor.• Check whether the OSD menu is locked. If yes, press and hold the Menu/function button next to the Power button for 4 seconds to unlock (for more information, see Lock).
No Input Signal when user controls are pressed	No picture, the LED light is white	<ul style="list-style-type: none">• Check the signal source. Ensure the computer is not in the power saving mode by moving the mouse or pressing any key on the keyboard.• Check whether the signal cable is plugged in properly. Re-plug the signal cable if necessary.• Reset the computer or video player.
The picture does not fill the entire screen	The picture cannot fill the height or width of the screen	<ul style="list-style-type: none">• Due to different video formats (aspect ratio) of DVDs, the monitor may display in full screen.• Run the built-in diagnostics.

No Video, No Display	No video when connecting docking, dongle or Blu-ray DVD players	<ul style="list-style-type: none"> Due to legacy platform cannot recognize or output 5120 x 1440, we suggest to change EDID to lower resolution to cover this compatibility problem: <ol style="list-style-type: none"> Remove all input cables, press Buttons 3 and 4 for 5 seconds. (Please refer to page 76 for button numbers) Choose "Enable" on POP up screen to change max resolution from 5120 x 1440 to 3840 x 1080.
Display image at 5120 x 1440 @ 30 Hz at HDMI port	Not able to select 5120 x 1440 @ 60 Hz in Graphic Control Panel at HDMI Port	<ul style="list-style-type: none"> Due to legacy platform HDMI 1.4 HW bandwidth limitation, it can only support 5120 x 1440 @ 30 Hz.
Monitor displayed image at 3840 x 1080 @ 60 Hz	Not able to select 5120 x 1440 in Graphic Control Panel	<ul style="list-style-type: none"> Due to legacy platform HW limitation, it does not support 5120 x 1440. To support 5120 x 1440 @ 60 Hz, check whether the platform meet either one of the following: <ol style="list-style-type: none"> DP1.2 or higher. Type-C Alt Mode DP1.2 or higher. HDMI 2.0.
Monitor displays image at 3840 x 1080 @ 60 Hz when using Intel Graphic Card	Not able to select 5120 x 1440 @ 60 Hz with: Intel CPU Gen10 or lower, and Intel Graphic Driver x.7584 onward.	<ul style="list-style-type: none"> Intel has disabled 5K Mode Support in Graphic Driver x.7584 onward, users should install Windows Registry Patch, which enables 5K Mode Support with Graphic Driver x.7584. Go to https://www.dell.com/support/home/us/en/04/product-support/product/dell-u4919dw-monitor/drivers to download the Registry Patch. Install/Re-install Intel Graphic driver before x7584.

Universal Serial Bus (USB) Specific Problems

Specific Symptoms	What You Experience	Possible Solutions
USB interface is not working	USB peripherals are not working	<ul style="list-style-type: none">• Check that your monitor is turned On.• Ensure USB Selection is set correctly in the USB Selection menu.• Reconnect the upstream cable to your computer.• Reconnect the USB peripherals (downstream connector).• Switch Off and then turn On the monitor again.• Reboot the computer.• Some USB devices like external portable HDD require higher electric current; connect the device directly to the computer system.• Disconnect one upstream USB cable when using two upstream connections.
USB Type-C port does not supply power	USB peripherals can not be charged	<ul style="list-style-type: none">• Check that the connected device is compliant with the USB-C specification. The USB Type-C port supports USB 2.0 and an output of 90 W.• Check that you use the USB Type-C cable shipped with your monitor.

High Speed USB 3.0 interface is slow	High Speed USB 3.0 peripherals working slowly or not working at all	<ul style="list-style-type: none"> • Check that your computer is USB 3.0-capable. • Some computers have USB 3.0, USB 2.0, and USB 1.1 ports. Ensure that the correct USB port is used. • Reconnect the upstream cable to your computer. • Reconnect the USB peripherals (downstream connector). • Reboot the computer.
Wireless mouse is not working or lagging	Do not respond or responds slowly	<ul style="list-style-type: none"> • Increase the distance between the USB 3.0 peripherals and the wireless USB receiver. • Position your wireless USB receiver as close as possible to the wireless mouse. • Use a USB-extender cable to position the wireless USB receiver as far away as possible from the USB 3.0 port.