

Service
Service
Service



Simplified

Service Manual

Important Safety Notice

Proper service and repair is important to the safe, reliable operation of all DELL Company Equipment. The service procedures recommended by DELL and described in this service manual are effective methods of performing service operations. Some of these service operations require the use of tools specially designed for the purpose. The special tools should be used when and as recommended.

It is important to note that this manual contains various CAUTIONS and NOTICES which should be carefully read in order to minimize the risk of personal injury to service personnel. The possibility exists that improper service methods may damage the equipment. It is also important to understand that these CAUTIONS and NOTICES ARE NOT EXHAUSTIVE. DELL could not possibly know, evaluate and advise the service trade of all conceivable ways in which service might be done or of the possible hazardous consequences of each way. Consequently, DELL has not undertaken any such broad evaluation. Accordingly, a servicer who uses a service procedure or tool which is not recommended by DELL must first satisfy himself thoroughly that neither his safety nor the safe operation of the equipment will be jeopardized by the service method selected.

Hereafter throughout this manual, DELL Company will be referred to as DELL.

WARNING

Use of substitute replacement parts, which do not have the same, specified safety characteristics may create shock, fire, or other hazards.

Under no circumstances should the original design be modified or altered without written permission from DELL. DELL assumes no liability, express or implied, arising out of any unauthorized modification of design.

Servicer assumes all liability.

FOR PRODUCTS CONTAINING LASER:

DANGER-Invisible laser radiation when open. AVOID DIRECT EXPOSURE TO BEAM.

CAUTION-Use of controls or adjustments or performance of procedures other than those specified herein may result in hazardous radiation exposure.

CAUTION -The use of optical instruments with this product will increase eye hazard.

TO ENSURE THE CONTINUED RELIABILITY OF THIS PRODUCT, USE ONLY ORIGINAL MANUFACTURER'S REPLACEMENT PARTS, WHICH ARE LISTED WITH THEIR PART NUMBERS IN THE PARTS LIST SECTION OF THIS SERVICE MANUAL.

Take care during handling the LCD module with backlight unit

- Must mount the module using mounting holes arranged in four corners.
- Do not press on the panel, edge of the frame strongly or electric shock as this will result in damage to the screen.
- Do not scratch or press on the panel with any sharp objects, such as pencil or pen as this may result in damage to the panel.
- Protect the module from the ESD as it may damage the electronic circuit (C-MOS).
- Make certain that treatment person's body is grounded through wristband.
- Do not leave the module in high temperature and in areas of high humidity for a long time.
- Avoid contact with water as it may a short circuit within the module.
- If the surface of panel becomes dirty, please wipe it off with a soft material. (Cleaning with a dirty or rough cloth may damage the panel.)

1. Exploded view diagram with list of items

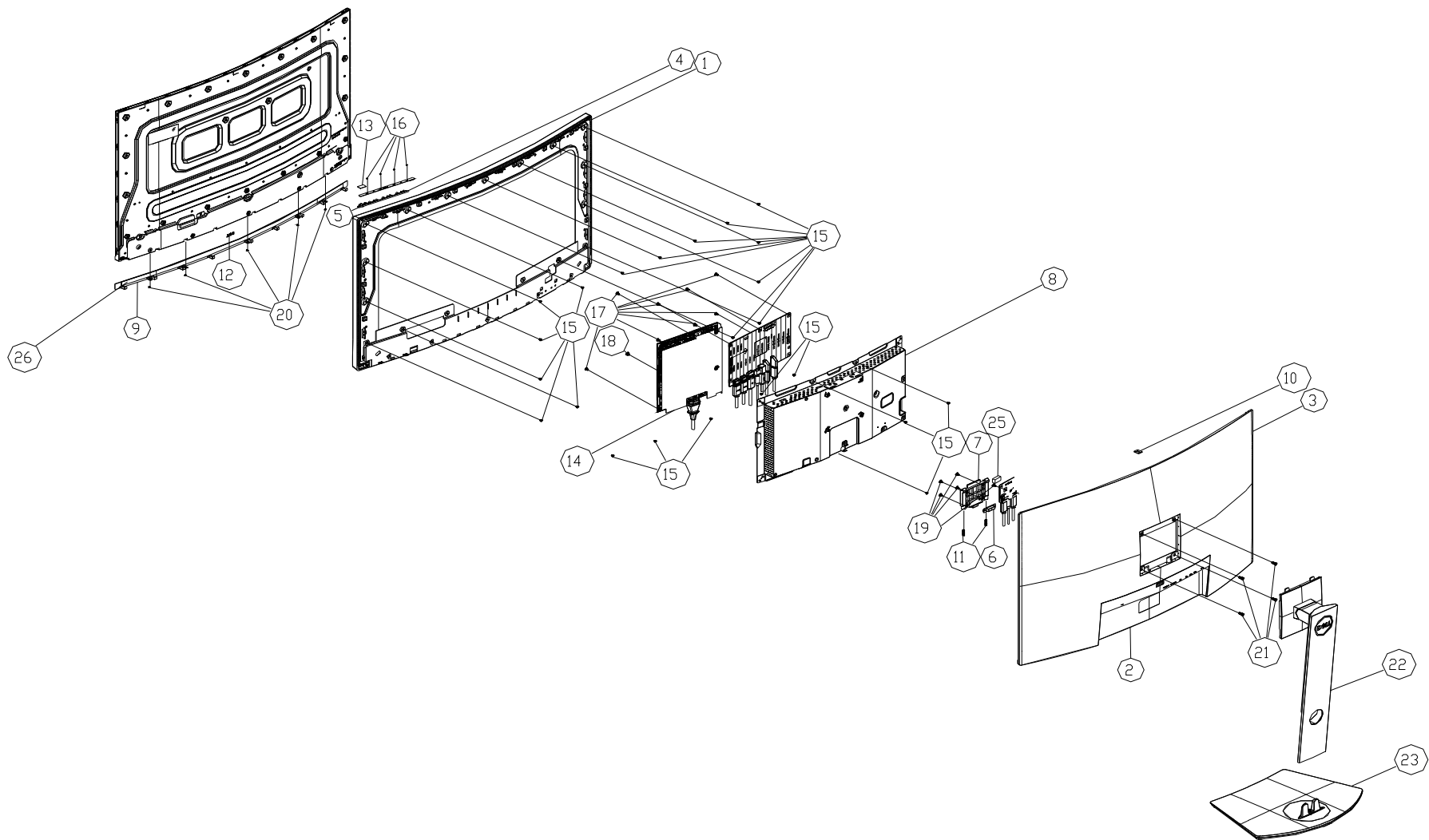

No.	Description	Q'ty				
1	MIDDLE_FRAME	1				
2	Cover_IO	1				
3	REAR_COVER NA	1				
4	KEY	1				
5	KEY_POWER	1				
6	STAND_BUTTON	1				
7	Latch	1				
8	MAINFRAME	1				
9	BEZEL_BTM	1				
10	BKT_LOCKER	1	No.	Part No.	Description	Q'ty
11	SPRING	2	15	0M1G3030 4120	SCREW 3 4(MIDDLEFRAME/PANEL)	20
12	LOGO DELL	1	15	0M1G3030 4120	SCREW 3 4(MIDDLEFRAME/PANEL)	3
13	TAPE_ACETATE	1	16	Q01G6019 1	SCREW (MIDDLE FRAME/KEY BOARD)	4
14	INSULATING SHEET	1	17	0D1G1030 6120	SCREW D3 6(MAIN BOARD/POWER BOARD/MAINFRAME)	8
22	STANDASS'Y	1	18	QM1G38400601200ARA	SCREW -- 6mm(POWER BOARD/MAINFRAME)	1
23	BASE_ASS'Y	1	19	0Q1G2030 6120	SCREW M3 6(LATCH /REAR COVER)	1
24	PANEL	1	19	0Q1G2030 6120	SCREW M3 6(LATCH /REAR COVER)	4
25	GASKET	1	20	QM1G31300301200ARA	SCREW 3 3(DECO BEZEL/PANEL)	5
26	SPONGE	1	21	0M1G2940 10225 CR3	SCREW M4 10(STAND/REAR COVER)	4

2. Wiring connectivity diagram

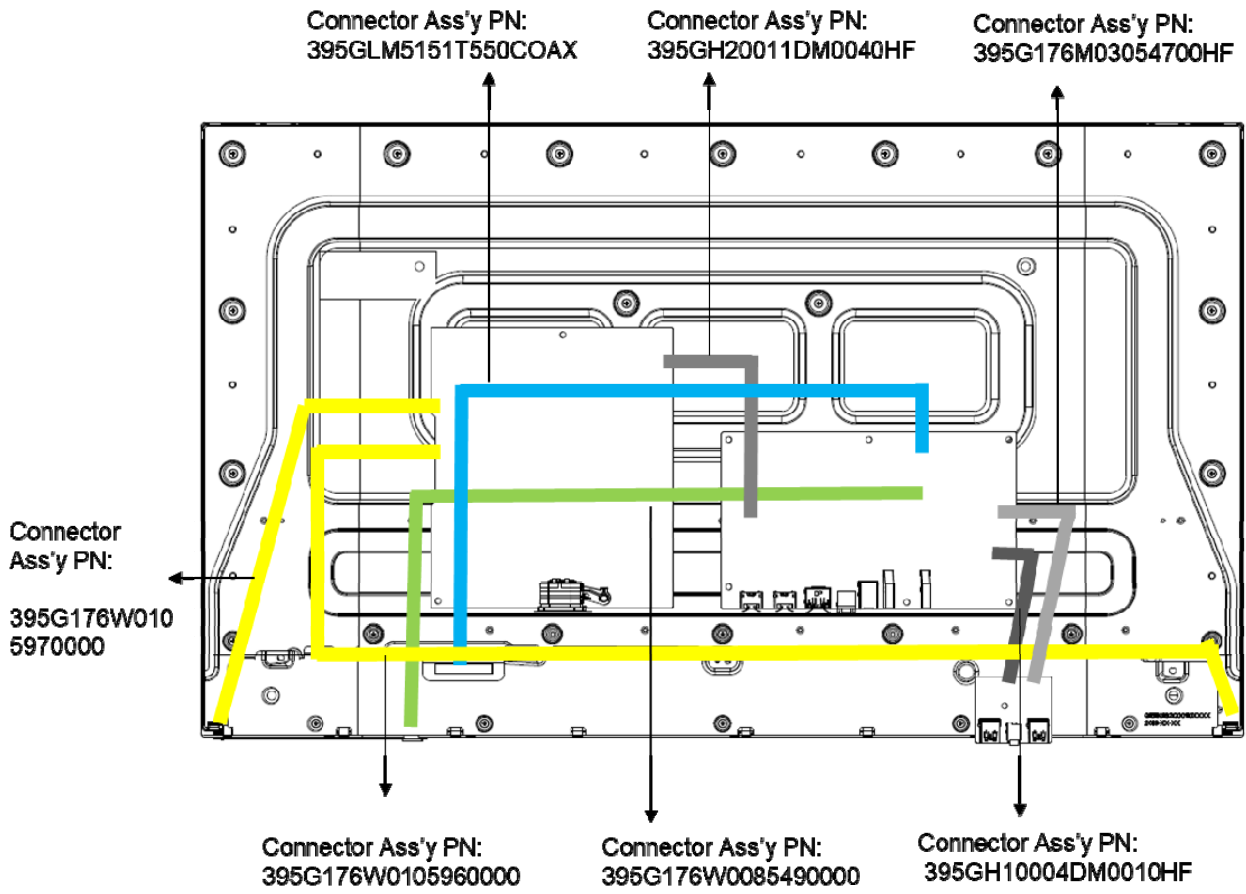

3. Mechanical Instruction



Tools Required

List the type and size of the tools that would typically can be used to disassemble the product to a point where components and materials requiring selective treatment can be removed.

Tool Description:

- Phillip head Screwdriver
- Hex Screwdriver
- Penknife

3.1 Disassembly Procedures:

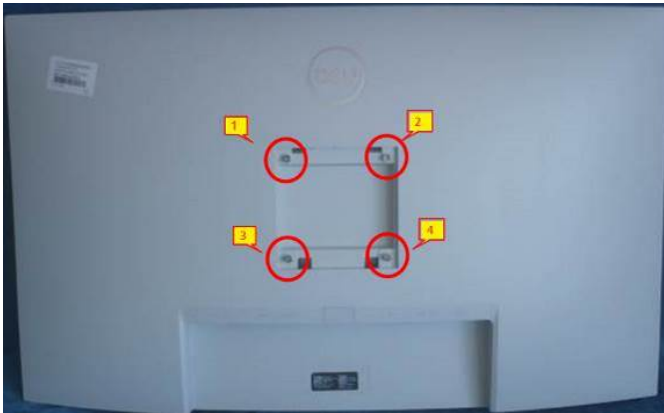
Step	Figure	Remark
<p>S1.Before disassemble</p>		<p>Turn off power, Unplug external cables from product</p>
<p>S2.Remove the STAND-BASE ASS'Y</p>		
<p>S3.Remove the REAR COVER</p>		<p>Use a Philips-head screwdriver to remove 4 screws for unlocking mechanisms. (No.1~4 screw size=M4x10; Torque: 12±2kgf.cm)</p> <p>Use Penknife to</p>

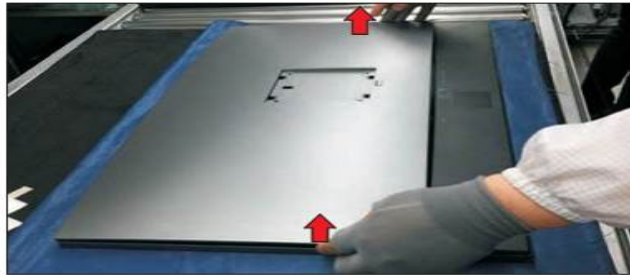

separate the bezel and rear cover follow the arrows in sequence, then you can take out rear cover.

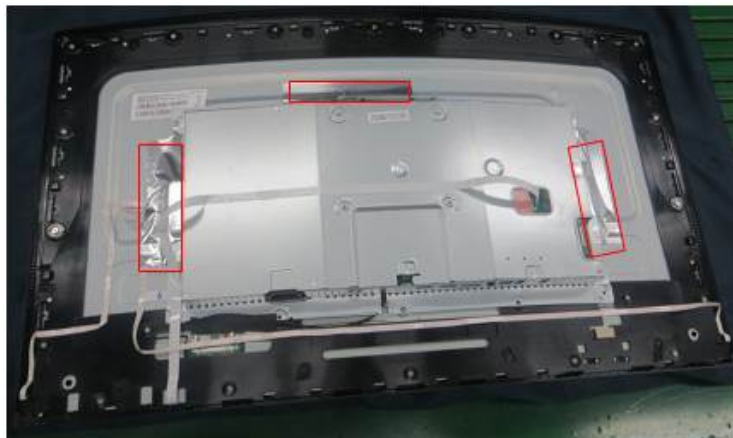

Tear off the aluminum foils and Disconnect the cables

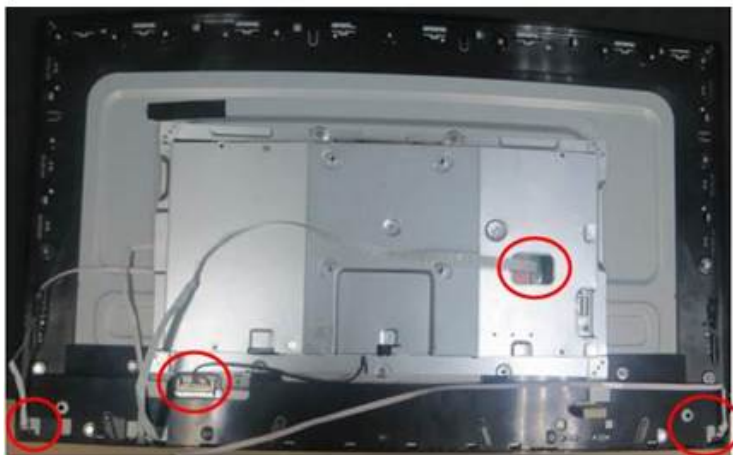

Use a Philips-head screwdriver to remove 3 screws for unlocking the mainframe
 (No.1~3 Screw size=M3x4, Torque: 3±0.5kgf.cm)

S4. Remove the main frame

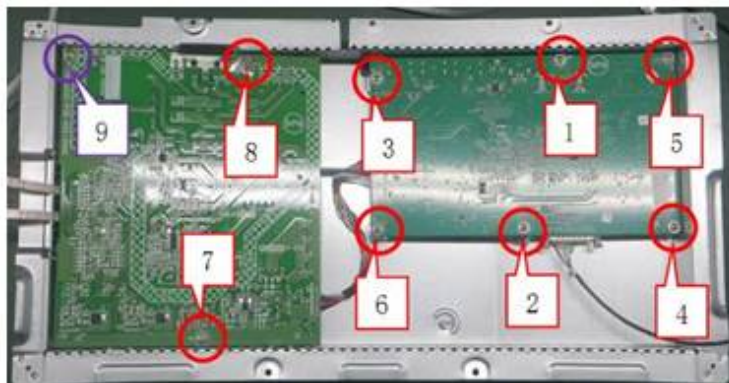
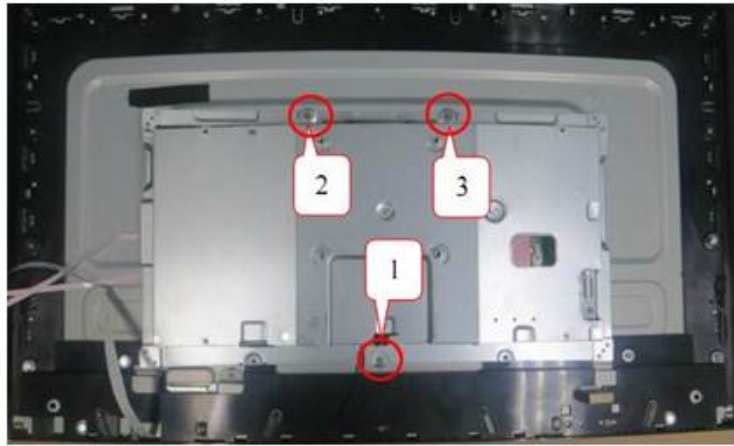

S5.Remove main board and power board

Remove the Mylar.
Use a Philips-head screwdriver to remove 4 screws for unlocking the main board and the adapter board



(No.1~8 screw size=D3x6,

Torque: $6 \pm 1 \text{ kgf.cm}$)

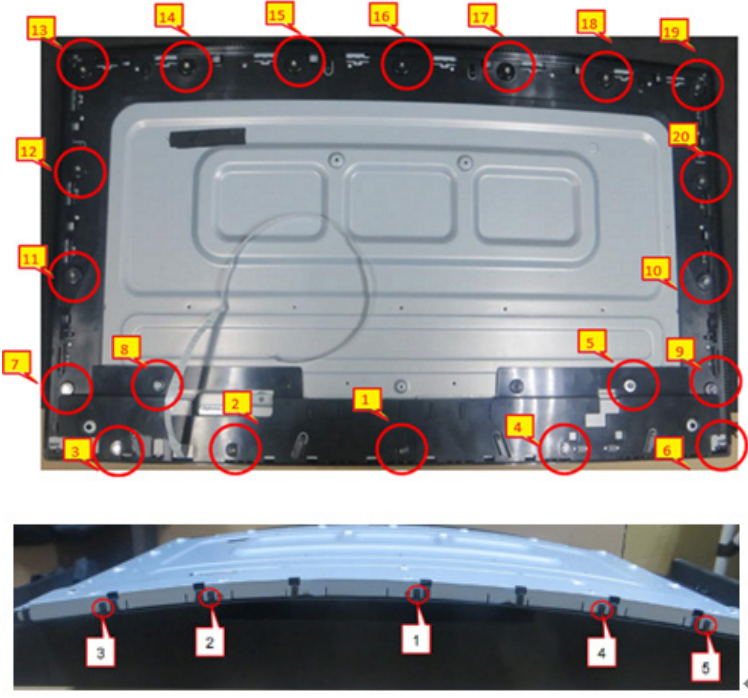

(No.9 screw size=M4x6,

Torque: $6 \pm 1 \text{ kgf.cm}$)

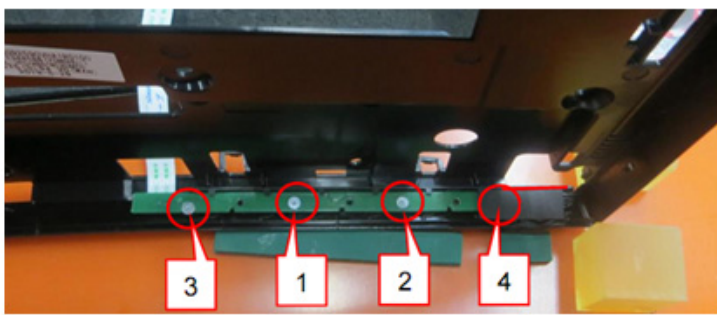
Disconnect all of the cables

<p>S6.Remove the bezel and panel</p>		<p>Use a Philips-head screwdriver to remove 20 screws for unlocking the middle plastic bezel with the whole unit, and then remove the middle plastic bezel carefully. (No.1~20 screw size=M3x4, Torque=3±0.5kgfcm)</p> <p>Use a Philips-head screwdriver to remove 5 screws for unlocking the BEZEL_BTM and the Panel. (No.1~5 screw size=M3x3, Torque=3±0.5kgf.cm)</p>
<p>S7.Remove the USB board</p>		<p>Use a Philips-head screwdriver to remove 1 screws to remove the USB board. Disconnect the cables of the USB board (No.1 screw size=M3x6, Torque=4±1kgf.cm)</p>
<p>S8. Remove the Key board</p>		<p>Use a Philips-head screwdriver to remove 4 screws for unlocking the key board and the middle frame. Disconnect the pin. (No.1~4 screw size=Q2x2.5, Torque=0.9±0.4kgf.cm)</p>

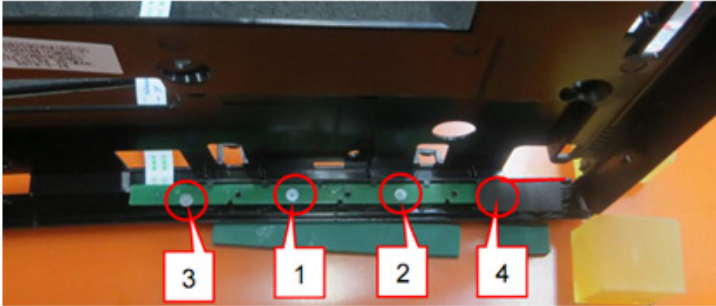
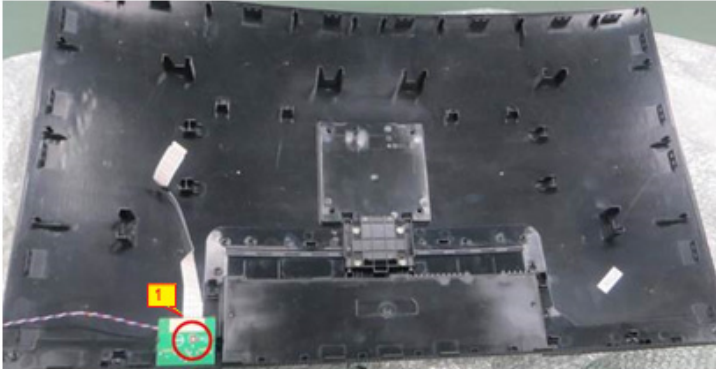
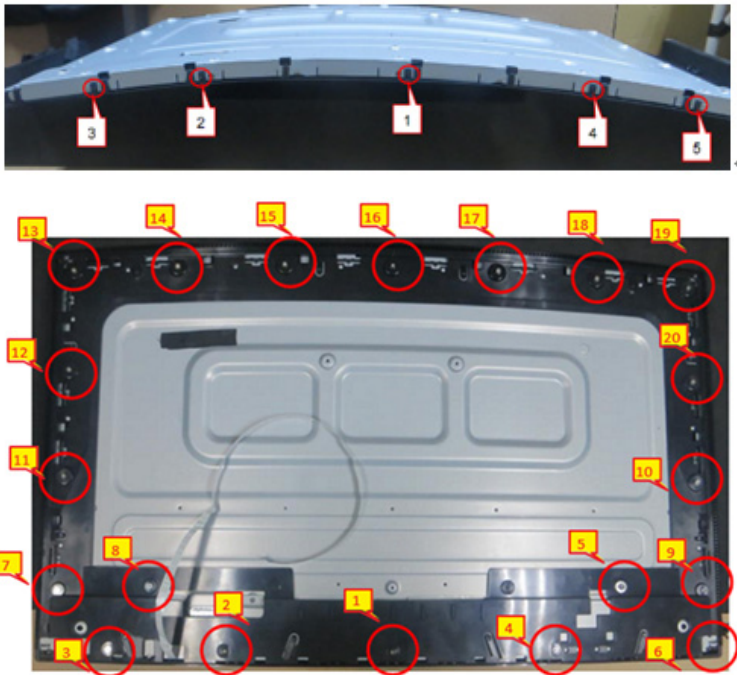
3.2 Assembly Procedures:

Step	Figure	Remark
<p>S1.Assembly the Key board</p>		<p>Use a Philips-head screwdriver to tighten 4 screws for locking the Key board (No.1~4 screw size=Q2x2.5, Torque=0.9±0.4kgf.cm)</p>
<p>S2.Assembly the USB BOARD</p>		<p>Connect the cables of the USB board Use a Philips-head screwdriver to screw 1 screw for locking the USB board. (No.1 screw size=M3x6, Torque=4±1kgf.cm)</p>
<p>S3.Assembly the Bezel and panel</p>		<p>Use a Philips-head screwdriver to screw 5 screws for locking the BEZEL_BTM and the Panel. (No.1~5 screw size=M3x3, Torque=3±0.5kgf.cm)</p> <p>Use a Philips-head screwdriver to screw 20 screws for locking the middle plastic bezel with the whole unit, and then remove the middle plastic bezel carefully. (No.1~20 screw size=M3x4, Torque=3±0.5kgfcm)</p>
<p>S4. Assembly the MAIN board and power board</p>		

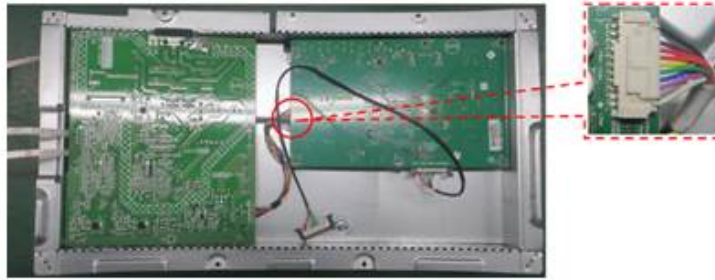

Connect all of the cables

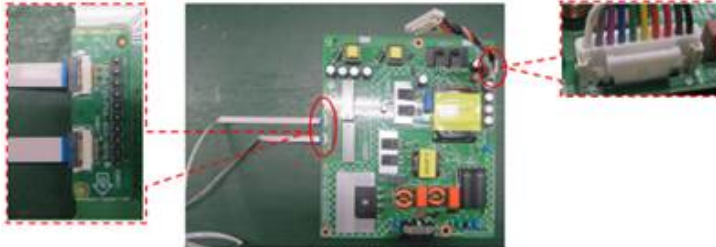

Use a Philips-head screwdriver to screw 4 screws for locking the main board and the adapter board

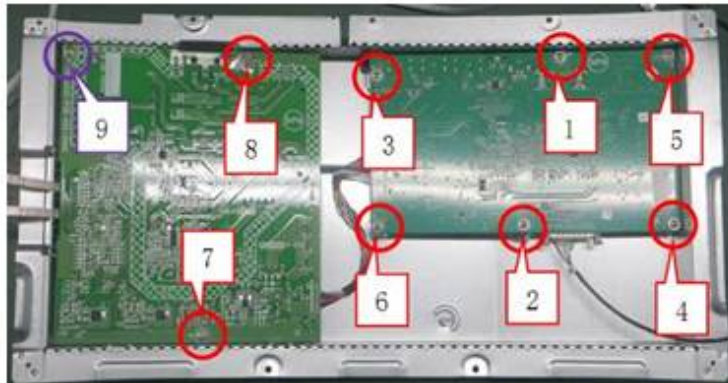

(No.1~8 screw size=D3x6,

Torque: $6 \pm 1 \text{ kgf.cm}$)

(No.9 screw size=M4x6,

Torque: $6 \pm 1 \text{ kgf.cm}$)



Paste the Mylar.

S5. Assembly the Main Frame

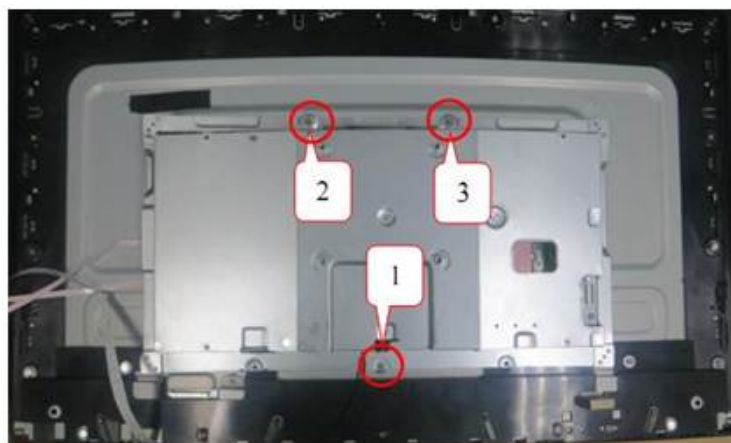

Use a Philips-head screwdriver to screw 3 screws for locking the mainframe

(No.1~3 Screw size=M3x4,

Torque: $3 \pm 0.5 \text{ kgf.cm}$)

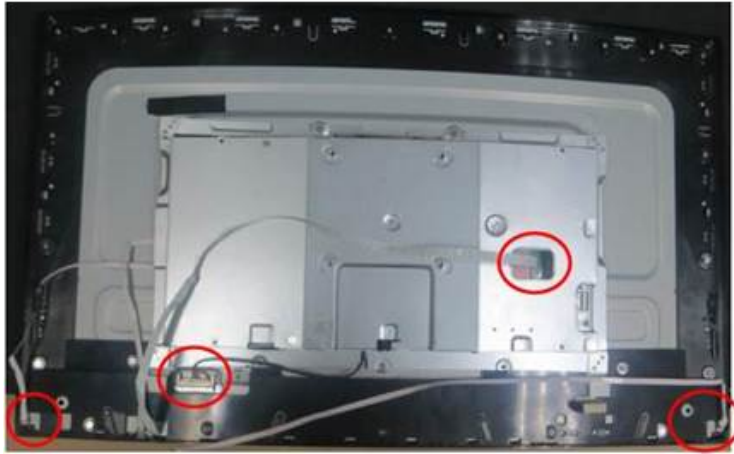

Connect the cables

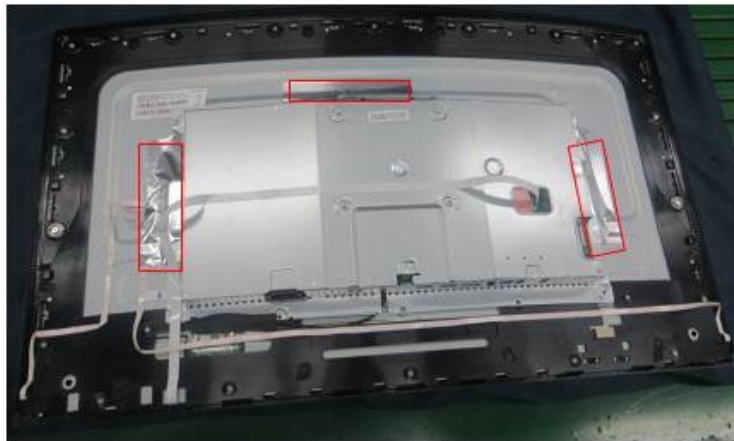

Paste the aluminum foils

S6.Assembly the Rear cover

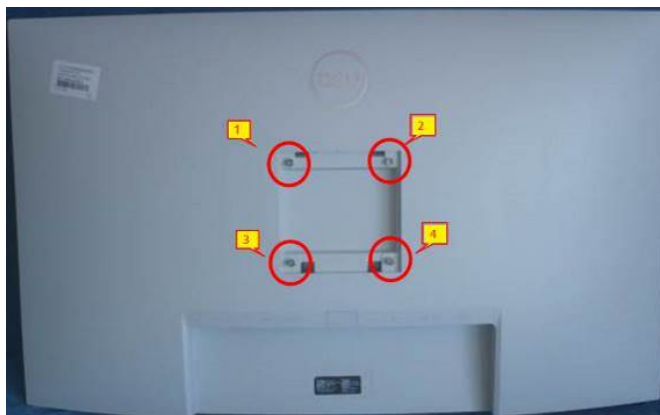
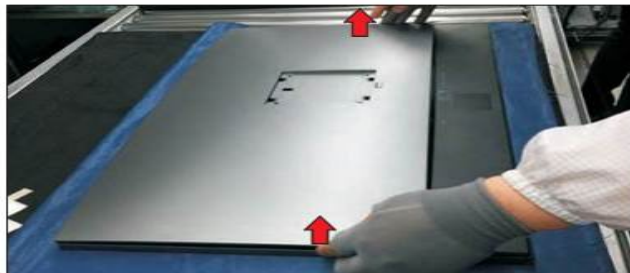

Use a Philips-head screwdriver to screw 4 screws for locking Rear cover.

(No.1~4 screw size=M4x10; Torque: 12±2kgf.cm)

**S7.Assembly the
Stand**



4. Trouble shooting instructions

⚠ WARNING: Before you begin any of the procedures in this section, follow the [Safety Instructions](#).

Self-Test

Your monitor provides a self-test feature that allows you to check if your monitor is functioning properly. If your monitor and computer are properly connected but the monitor screen remains dark, run the monitor self-test by performing the following steps:

1. Turn off both your computer and the monitor.
2. Disconnect all video cables from the monitor. This way, the computer doesn't have to be involved.
3. Turn on the monitor.

If the monitor is working correctly, it detects that there is no signal and one of the following message appears. While in self-test mode, the power LED remains white.

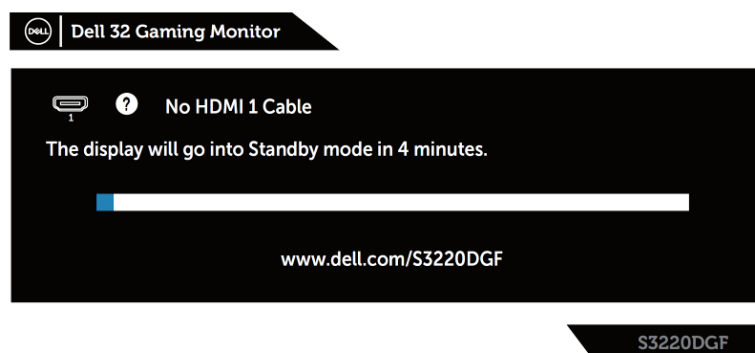

✎ NOTE: This box also appears during normal system operation, if the video cable is disconnected or damaged.

4. Turn Off your monitor and reconnect the video cable; then turn on your computer and the monitor.

If your monitor remains dark after you reconnect the cables, check your video controller and computer.

Built-in diagnostics

Your monitor has a built-in diagnostic tool that helps you determine if any screen abnormality you experience is an inherent problem with your monitor, or with your computer and video card.

 **NOTE: You can run the built-in diagnostics only when the video cable is unplugged and the monitor is in self-test mode.**

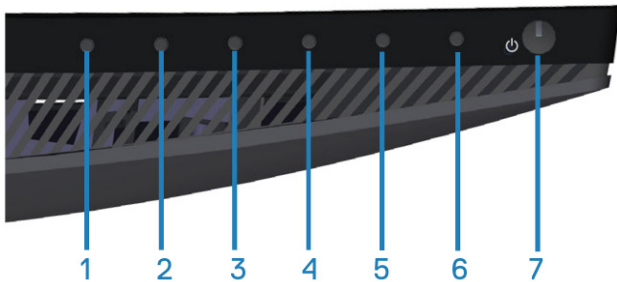

To run the built-in diagnostics:

1. Ensure that the screen is clean (no dust particles on the surface of the screen).
2. Unplug the video cable(s) from the back of the computer or monitor. The monitor then goes into the self-test mode.
3. Press and hold Button 3 for 5 seconds. A gray screen appears.
4. Carefully inspect the screen for abnormalities.
5. Press Button 3 on the bottom of the monitor again. The color of the screen changes to red.
6. Inspect the display for any abnormalities.
7. Repeat steps 5 and 6 to inspect the display in green, blue, black, white and text screens.

The test is complete when the text screen appears. To exit, press Button 3 again.

If you do not detect any screen abnormalities upon using the built-in diagnostic tool, the monitor is functioning properly. Check the video card and computer.

Common problems

The following table contains general information about common monitor problems you might encounter and the possible solutions:

Common Symptoms	Possible Solutions
No Video/Power LED off	<ul style="list-style-type: none">• Ensure that the video cable connecting the monitor and the computer is properly connected and secure.• Verify that the power outlet is functioning properly using any other electrical equipment.• Ensure that the power button is pressed.• Ensure that the correct input source is selected via the Input Source menu.
No Video/Power LED on	<ul style="list-style-type: none">• Increase brightness and contrast controls using the OSD.• Perform monitor self-test feature check.• Check for bent or broken pins in the video cable connector.• Run the built-in diagnostics.• Ensure that the correct input source is selected via the Input Source menu.
Poor Focus	<ul style="list-style-type: none">• Eliminate video extension cables.• Reset the monitor to Factory Settings (Factory Reset).• Change the video resolution to the correct aspect ratio.
Shaky/Jittery Video	<ul style="list-style-type: none">• Reset the monitor to Factory Settings (Factory Reset).• Check environmental factors.• Relocate the monitor and test in another room.
Missing Pixels	<ul style="list-style-type: none">• Cycle power On-Off.• Pixel that is permanently Off is a natural defect that can occur in LCD technology.• For more information on Dell Monitor Quality and Pixel Policy, see Dell Support site at: www.dell.com/support/monitors.

Stuck-on Pixels	<ul style="list-style-type: none"> ● Cycle power On-Off. ● Pixel that is permanently off is a natural defect that can occur in LCD technology. ● For more information on Dell Monitor Quality and Pixel Policy, see Dell Support site at: www.dell.com/support/monitors.
Brightness Problems	<ul style="list-style-type: none"> ● Reset the monitor to Factory Settings (Factory Reset). ● Adjust brightness & contrast controls via OSD.
Geometric Distortion	<ul style="list-style-type: none"> ● Reset the monitor to Factory Settings (Factory Reset). ● Adjust horizontal & vertical controls via OSD.
Horizontal/Vertical Lines	<ul style="list-style-type: none"> ● Reset the monitor to Factory Settings (Factory Reset). ● Perform monitor self-test feature check and determine if these lines are also in self-test mode. ● Check for bent or broken pins in the video cable connector. ● Run the built-in diagnostics.
Synchronization Problems	<ul style="list-style-type: none"> ● Reset the monitor to Factory Settings (Factory Reset). ● Perform monitor self-test feature check to determine if the scrambled screen appears in self-test mode. ● Check for bent or broken pins in the video cable connector. ● Restart the computer in the safe mode.
Safety Related Issues	<ul style="list-style-type: none"> ● Do not perform any troubleshooting steps. ● Contact Dell immediately.
Intermittent Problems	<ul style="list-style-type: none"> ● Ensure that the video cable connecting the monitor to the computer is connected properly and is secure. ● Reset the monitor to Factory Settings (Factory Reset). ● Perform monitor self-test feature check to determine if the intermittent problem occurs in self-test mode.
Missing Color	<ul style="list-style-type: none"> ● Perform monitor self-test feature check. ● Ensure that the video cable connecting the monitor to the computer is connected properly and is secure. ● Check for bent or broken pins in the video cable connector.

Wrong Color	<ul style="list-style-type: none"> ● Change the Color Setting Mode in the Color Settings OSD to Graphics or Video depending on the application. ● Try different Preset Modes in Color settings OSD. Adjust R/G/B value in Custom Color in Color settings OSD. ● Change the Input Color Format to RGB or YPbPr in the Color settings OSD. ● Run the built-in diagnostics.
Image retention from a static image left on the monitor for a long period of time	<ul style="list-style-type: none"> ● Set the screen to turn off after a few minutes of screen idle time. These can be adjusted in Windows Power Options or Mac Energy Saver setting. ● Alternatively, use a dynamically changing screensaver.
Video Ghosting or Overshooting	<ul style="list-style-type: none"> ● Change the Response Time in the Display OSD to Fast, Super Fast or Extreme depending on your application and usage.

Product-specific problems

Specific Symptoms	Possible Solutions
Screen image is too small	<ul style="list-style-type: none"> ● Check the Aspect Ratio setting in the Display settings OSD. ● Reset the monitor to Factory Settings (Factory Reset).
Cannot adjust the monitor with the buttons on the bottom of the panel	<ul style="list-style-type: none"> ● Turn Off the monitor, unplug the power cord, plug it back, and then turn On the monitor. ● Check if the OSD menu is locked. If yes, press and hold the menu button for 6 seconds to unlock.
No Input Signal when user controls are pressed	<ul style="list-style-type: none"> ● Check the signal source. Ensure the computer is not in standby or sleep mode by moving the mouse or pressing any key on the keyboard. ● Check if the video cable is plugged in properly. Disconnect and reconnect the video cable if necessary. ● Reset the computer or video player.
The picture does not fill the entire screen	<ul style="list-style-type: none"> ● Due to different video formats (aspect ratio) of DVDs, the monitor may display in full screen. ● Run the built-in diagnostics.

Appendix

Safety Instructions

⚠ WARNING: Use of controls, adjustments, or procedures other than those specified in this documentation may result in exposure to shock, electrical hazards, and/or mechanical hazards.

For information on safety instructions, see the **Safety Environment and Regulatory Information (SERI)**.

FCC notices (U.S. Only) and other regulatory information

For FCC notices and other regulatory information, see the regulatory compliance website located at www.dell.com/regulatory_compliance.

Please follow these safety instructions for best performance, and long life for your monitor:

1. The socket-outlet shall be installed near the equipment and shall be easily accessible.
2. The equipment can be installed on wall or ceiling mounting in horizontal position.
3. The monitor is equipped with a three-pronged grounded plug, a plug with a third (Grounding) pin.
4. Do not use this product near water.
5. Read these instructions carefully. Keep this document for future reference. Follow all warnings and instructions marked on product.
6. Excessive sound pressure from earphones and headphones can cause hearing loss. Adjustment of the equalizer to maximum increases the earphones and headphones output voltage and therefore the sound pressure level.