

Dell Projector 1550/1650 User's Guide



Notes, Cautions, and Warnings



NOTE: A NOTE indicates important information that helps you make better use of your projector



CAUTION: A CAUTION indicates potential damage to hardware or loss of data if instructions are not followed.



WARNING: A WARNING indicates a potential for property damage, personal injury, or death.

**Information in this document is subject to change without notice.
© 2018 Dell Inc. All rights reserved.**

Reproduction of these materials in any manner whatsoever without the written permission of Dell Inc. is strictly forbidden.

Trademarks used in this text: Dell and the DELL logo are trademarks of Dell Inc.; DLP and DLP logo are trademarks of TEXAS INSTRUMENTS INCORPORATED; Microsoft and Windows are either trademarks or registered trademarks of Microsoft Corporation in the United States and/or other countries.

Other trademarks and trade names may be used in this document to refer to either the entities claiming the marks and names or their products. Dell Inc. disclaims any proprietary interest in trademarks and trade names other than its own.

Model: Dell Projector 1550/1650

January 2018 Rev. A02

Contents

1	About Your Dell Projector	4
	Projector Box Contents	4
	Projector Top and Bottom View	5
	Projector Connections.	6
	Using Remote Control.	8
2	Adjusting Projector Image	12
	Adjusting Projected Zoom	12
	Adjusting Projector Focus.	13
	Adjusting Image Size	14
3	Troubleshooting	19
	Troubleshooting Tips.	19
	Guiding Signals	23
4	Maintenance	24
	Changing the Lamp.	24
	Replacing Remote Control Batteries	26
5	Specifications	27
6	Additional Information	31
7	Contacting Dell	32

1

About Your Dell Projector

Your projector comes with all the items shown below. Ensure that you have all the items, and contact Dell if anything is missing.

Projector Box Contents

Package Contents

Power cable

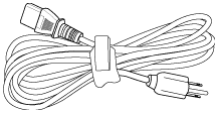

VGA cable (VGA to VGA)

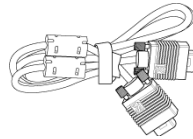

Remote control



AAA Batteries (2)



CD, User's Guide, and Documentation

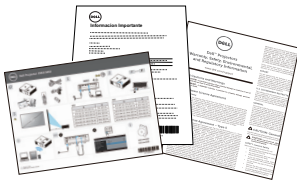

Projector Top and Bottom View

Top View

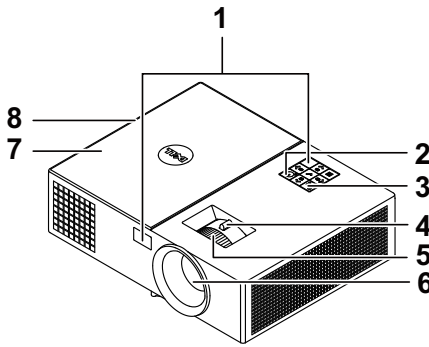

Bottom View

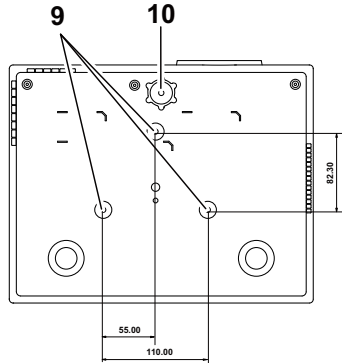

- | | |
|----|----------------------------------|
| 1 | IR receivers |
| 2 | Power button |
| 3 | Status indicators |
| 4 | Zoom tab |
| 5 | Focus ring |
| 6 | Lens |
| 7 | Lamp cover |
| 8 | 10W speaker |
| 9 | Mounting holes for ceiling mount |
| 10 | Tilt adjustment wheel |



NOTE: Ceiling mount screw hole M3 x 6.5 mm depth.
Recommended torque < 15 kgf-cm.

Projector Connections

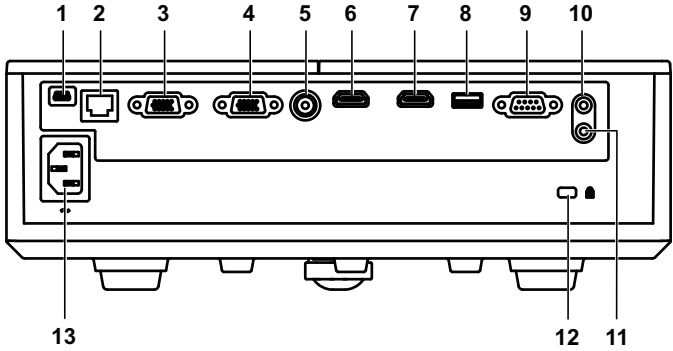

1	Mini USB (mini type B) connector for firmware upgrade	8	+ 5V/1.8A DC out connector
2	RJ-45 connector	9	RS232 connector
3	VGA input connector	10	Audio input connector
4	VGA output (monitor loop through) connector	11	Audio output connector
5	Composite Video connector	12	Security cable slot
6	HDMI-1 connector	13	Power cord connector
7	HDMI-2 connector		

CAUTION: Before you begin any of the procedures in this section, follow the Safety Instructions as described on page 7.

CAUTION: Safety Instructions

- 1 Do not use the projector near appliances that generate a lot of heat.
- 2 Do not use the projector in areas where there is an excessive amount of dust. The dust may cause the system to fail and the projector will automatically shutdown.
- 3 Ensure that the projector is mounted in a well-ventilated area.
- 4 Do not block the ventilation slots and openings on the projector.
- 5 Ensure the projector operates between ambient temperatures (5 °C to 40 °C).
- 6 Do not try to touch the ventilation outlet as it can become very hot after the projector has been turned on or immediately after it is turned off.
- 7 Do not look into the lens while the projector is on as it may cause injury to your eyes.
- 8 Do not place any objects near or in front of the projector or cover its lens while the projector is on as the heat may cause the object to melt or burn.
- 9 Do not use alcohol to wipe the lens.
- 10 Do not stare into the beam, RG2.







- 11 As with any bright source, do not stare into the direct beam, RG2 IEC 62471-5:2015.



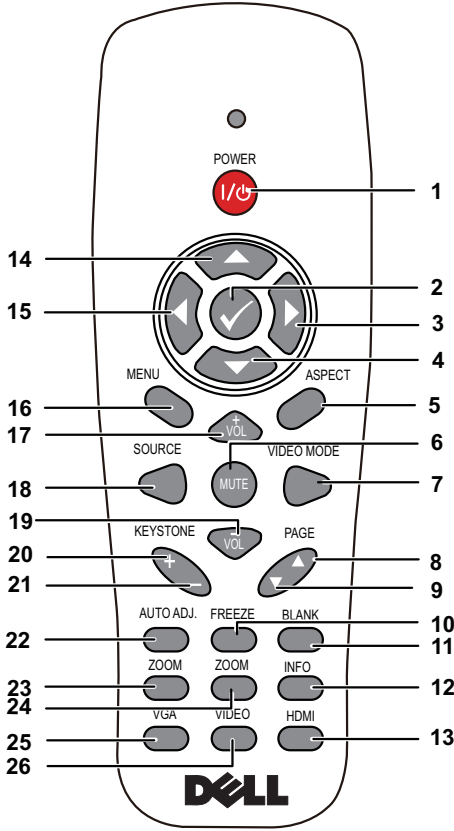





NOTE:

- Do not attempt to ceiling mount the projector by yourself. It should be installed by a qualified technician.
- Recommended Projector Ceiling Mount Kit (P/N: C3505). For more information, see the Dell Support website at [dell.com/support](https://www.dell.com/support).
- For more information, see the Safety Information that shipped with your projector.
- The 1550/1650 projector can only be used indoors.

Using Remote Control



1	Power 	Turns the projector on or off.
2	Enter 	Press to confirm the selection.
3	Right 	Press to navigate through the On-Screen Display (OSD) Menu items.
4	Down 	Press to navigate through the On-Screen Display (OSD) Menu items.
5	Aspect Ratio	Press to change the aspect ratio of a displayed image.

6	Mute 	Press to mute or un-mute the projector speaker.
7	Video mode	<p>The projector has preset configurations that are optimized for displaying data (presentation slides) or video (movies, games, etc.).</p> <p>Press the Video Mode button to toggle between Presentation mode, Bright mode, Movie mode, sRGB, or Custom mode.</p> <p>Pressing the Video Mode button once will show the current display mode. Pressing the Video Mode button again will switch between modes.</p>
8	Page up 	<p>Press to move to the previous page.</p> <p> NOTE: The Mini USB cable must be connected if you want to use the Page Up feature.</p>
9	Page down 	<p>Press to move to the next page.</p> <p> NOTE: The Mini USB cable must be connected if you want to use the Page Down feature.</p>
10	Freeze	Press to pause the screen image, then press "Freeze" again to unfreeze the image.
11	Blank screen	Press to hide/unhide the image.
12	Information	Press to provide projector native resolution information.
13	HDMI	Press to choose HDMI source.
14	Up 	Press to navigate through the On-Screen Display (OSD) Menu items.
15	Left 	Press to navigate through the On-Screen Display (OSD) Menu items.
16	Menu	Press to activate the OSD.
17	Volume up 	Press to increase the volume.
18	Source	Press to switch between Analog RGB, Composite, Component (YPbPr, via VGA), HDMI 1, and HDMI 2 source.

19	Volume down 	Press to decrease the volume.
20	Keystone adjustment +	Press to adjust image distortion caused by tilting the projector (+/-40 degrees).
21	Keystone adjustment -	Press to adjust image distortion caused by tilting the projector (+/-40 degrees).
22	Auto Adjust	Press to synchronize the projector with the input source. Auto adjust does not operate if the OSD is displayed.
23	Zoom +	Press to increase the image.
24	Zoom -	Press to decrease the image.
25	VGA	Press to choose VGA source.
26	Video	Press to choose Composite Video source.

Remote Control Operating Range

Operating range	
Angle	$\pm 30^\circ$
Distance	7 m/22.97 feet

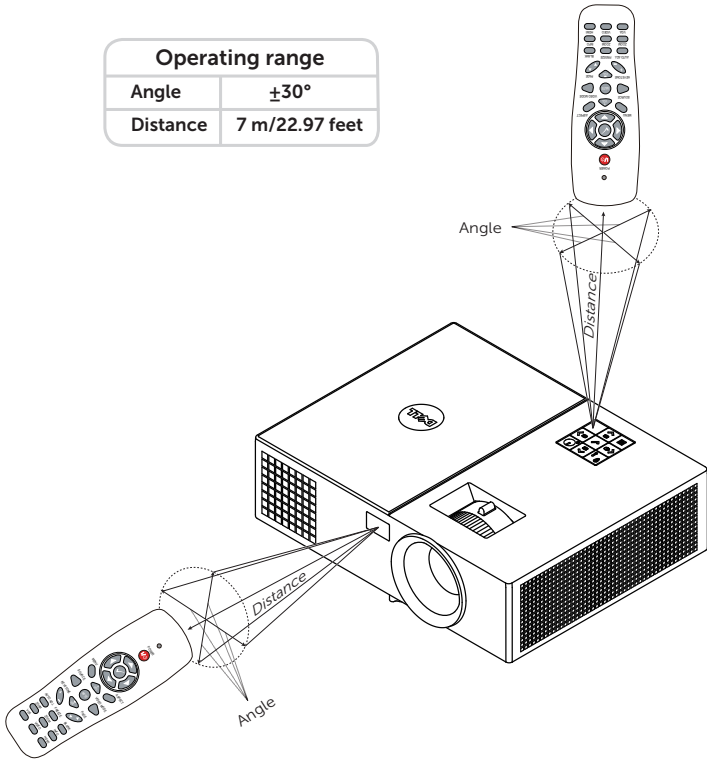

NOTE: Actual operating range may slightly differ from the diagram. Weak batteries will also prevent the remote control from properly operating the projector.

2

Adjusting Projector Image

Adjusting Projected Zoom

Raising the Projector Height

- 1 Raise the projector to the desired display angle, and use the front tilt adjustment wheel to fine-tune the display angle.

Lowering the Projector Height

- 1 Lower the projector, and use the front tilt adjustment wheel to fine-tune the display angle.

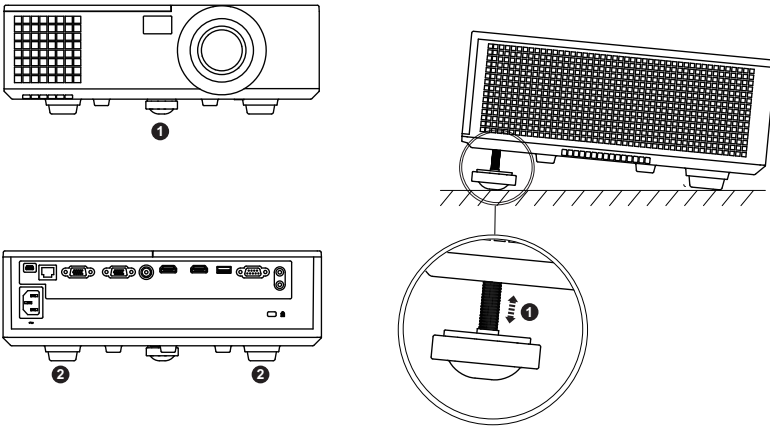

-
- | | |
|---|--|
| 1 | Front tilt adjustment wheel
(Angle of tilt: 0 to 5 degrees) |
| 2 | Fixed rubber foot |
-

Adjusting Projector Focus

1 Rotate the focus ring until the image is clear. The projector focuses at distances ranging between as below:

-> 1550: 51 ~ 397 inch (129 ~ 1008 cm)

-> 1650: 54 ~ 402 inch (138 ~ 1020 cm)

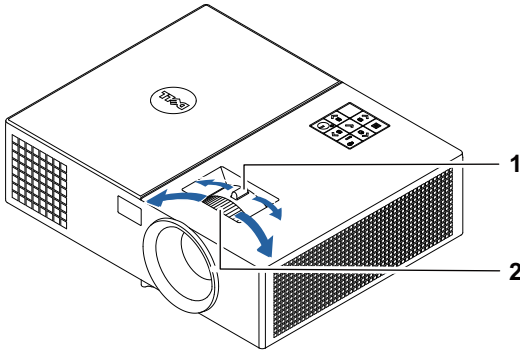

1 Zoom tab

2 Focus ring

Adjusting Image Size

1550

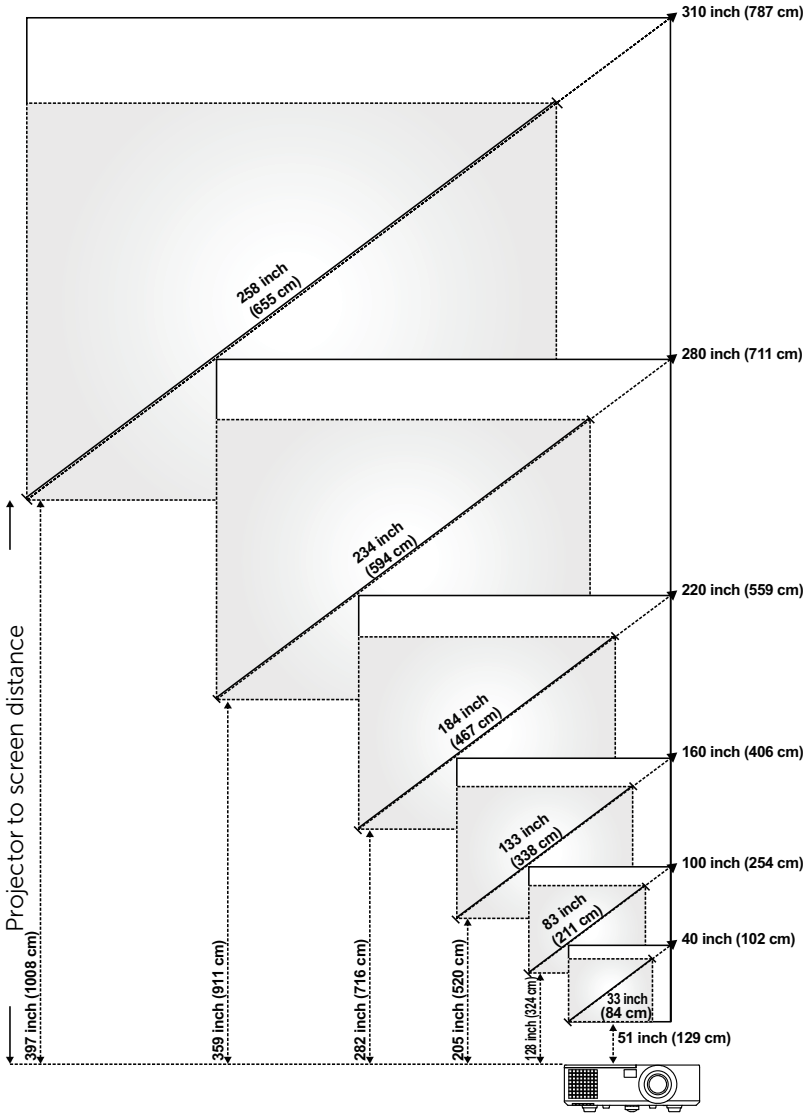

1650

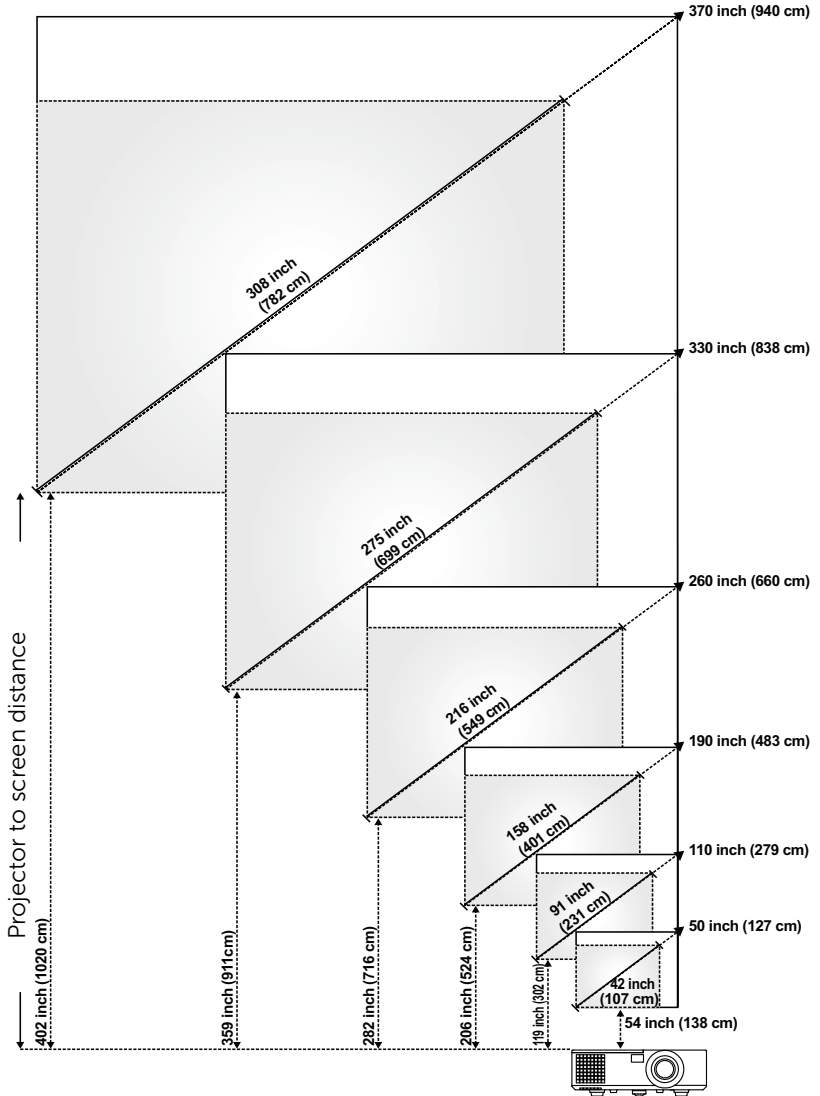

Adjusting Image Shape

1550

Projection Distance (cm) [A]	Min Zoom				
	Image size			Projector base to top of image (cm) [C]	Projector base to bottom of image (cm) [D]
	Diagonal (inch/cm) [B]	Width (cm) [W]	Height (cm) [H]		
129	33 inch/84 cm	76	50	58	8
324	83 inch/211 cm	169	127	146	19
520	133 inch/338 cm	271	203	234	31
716	184 inch/467 cm	373	280	322	42
911	234 inch/594 cm	474	356	409	53
1008	258 inch/655 cm	525	394	453	59

Projection Distance (cm) [A]	Max Zoom				
	Image size			Projector base to top of image (cm) [C]	Projector base to bottom of image (cm) [D]
	Diagonal (inch/cm) [B]	Width (cm) [W]	Height (cm) [H]		
129	40 inch/102 cm	81	60	70	10
324	100 inch/254 cm	203	152	175	23
520	160 inch/406 cm	325	244	280	36
716	220 inch/559 cm	448	336	386	50
911	280 inch/711 cm	569	427	491	64
1008	310 inch/787 cm	630	473	543	70

* This graph is for user reference only.

* Offset Ratio: 115±5%

1650

Projection Distance (cm) [A]	Min Zoom				
	Image size			Projector base to top of image (cm) [C]	Projector base to bottom of image (cm) [D]
	Diagonal (inch/cm) [B]	Width (cm) [W]	Height (cm) [H]		
138	42 inch/107 cm	90	56	63	7
302	91 inch/231 cm	197	123	138	15
524	158 inch/401 cm	341	213	240	27
716	216 inch/549 cm	466	291	327	36
911	275 inch/699 cm	593	391	417	46
1020	308 inch/782 cm	664	415	467	52

Projection Distance (cm) [A]	Max Zoom				
	Image size			Projector base to top of image (cm) [C]	Projector base to bottom of image (cm) [D]
	Diagonal (inch/cm) [B]	Width (cm) [W]	Height (cm) [H]		
138	50 inch/127 cm	108	67	76	9
302	110 inch/279 cm	236	147	166	19
524	190 inch/483 cm	409	256	288	32
716	260 inch/660 cm	559	350	393	43
911	330 inch/838 cm	712	445	500	55
1020	370 inch/940 cm	797	498	560	62

* This graph is for user reference only.

* Offset Ratio: 112.4±5%

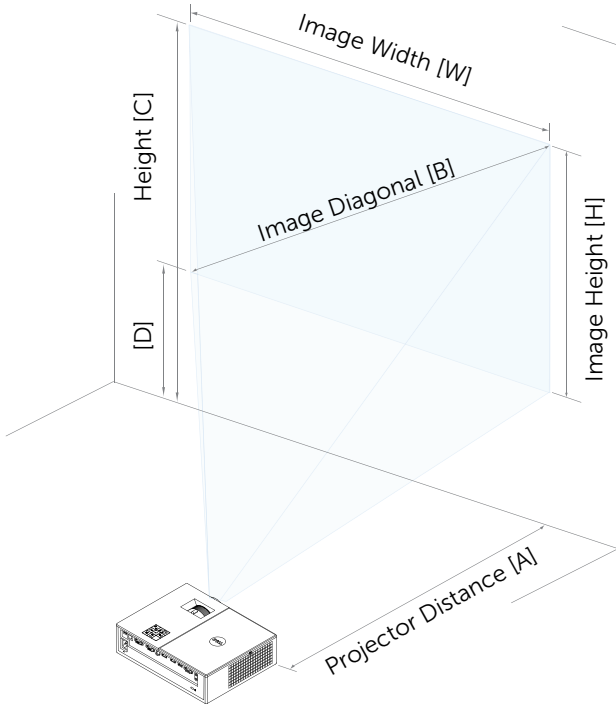

3

Troubleshooting

Troubleshooting Tips



If you experience problems with your projector, see the following troubleshooting tips. If the problem persists, contact Dell.



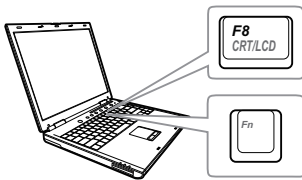

Problem

No image appears on the screen



Possible Solution

- Ensure that you have chosen the correct input source on the INPUT SOURCE menu.
 - Ensure the external graphics port is enabled. If you are using a Dell laptop computer, press   (Fn+F8). For other computers, see your respective documentation. If images are not displayed properly, please upgrade the video driver of your computer. For Dell computers, see www.dell.com/support.
 - Ensure that all the cables are securely connected. See "Adjusting Projector Image" on page 12.
 - Ensure that the pins of the connectors are not bent or broken.
 - Ensure that the lamp is securely installed (see "Changing the Lamp" on page 24).
 - Use the Test Pattern in the Projector Settings of the Advanced Settings menu. Ensure that the colors of the test pattern are correct.
-

Problem (continued)	Possible Solution (continued)
Partial, scrolling, or incorrectly displayed image	<p>1 Press the Auto Adjust button on the remote control.</p> <p>2 If you are using a Dell laptop computer, set the resolution of the computer to WXGA (1280 x 800) or XGA (1024 x 768):</p> <p>a Right-click the unused portion of your Microsoft® Windows® desktop, click Properties, and then select Settings tab.</p> <p>b Verify that the setting is 1280 x 800 or 1024 x 768 pixels for the external monitor port.</p> <p>c Press   (Fn+F8).</p> <p>If you experience difficulty in changing resolutions, or if your monitor freezes, restart all the equipment and the projector.</p> <p>If you are not using a Dell laptop computer, see your documentation. If images are not displayed properly, please upgrade the video driver of your computer. For a Dell computer, see www.dell.com/support.</p>
The screen does not display your presentation	If you are using a portable computer, press   (Fn+F8).
Image is unstable or flickering	Adjust the tracking in the OSD Display Settings of the Advanced Settings menu (in PC Mode only).
Image has vertical flickering bar	Adjust the frequency in the OSD Display Settings of the Advanced Settings menu (in PC Mode only).

Problem (continued)	Possible Solution (continued)
Image color is incorrect	<ul style="list-style-type: none"> • If the display receives the wrong signal output from the graphics card, please set the signal type to RGB in the OSD Image Settings of the Advanced Settings tab. • Use Test Pattern in the Projector Settings of the Advanced Settings menu. Ensure that the colors of the test pattern are correct.
Image is out of focus	<ol style="list-style-type: none"> 1 Adjust the focus ring on the projector lens. 2 Ensure that the projection screen is within the required distance from the projector: <ul style="list-style-type: none"> -> 1550: 51 in [129 cm] ~ 397 in [1008 cm] -> 1650: 54 in [138 cm] ~ 402 in [1020 cm]
The image is stretched when displaying a 16:9 DVD	<p>The projector automatically detects the input signal format. It will maintain the aspect ratio of the projected image according to the input signal format with an Original setting.</p> <p>If the image is still stretched, adjust the aspect ratio in the Display Settings of the Advanced Settings menu in the OSD.</p>
Image is reversed	<p>Select Projector Settings of the Advanced Settings from the OSD and adjust the projector mode.</p>
Lamp is burned out or makes a popping sound	<p>When the lamp reaches its end of life, it may burn out and may make a loud popping sound. If this occurs, the projector does not turn back on. To replace the lamp, see "Changing the Lamp" on page 24.</p>
LAMP light is solid amber	<p>If the LAMP light is solid amber, replace the lamp.</p>

Problem (continued)	Possible Solution (continued)
LAMP light is blinking amber	<p>If the LAMP light is blinking amber, the lamp module connection may be disrupted. Please check the lamp module and ensure that it is properly installed.</p> <p>If the LAMP lights and the Power light is blinking amber, the lamp driver has failed and the projector will automatically shut down.</p> <p>If the LAMP and TEMP lights are blinking amber and the Power light is solid blue, the color wheel has failed and the projector will automatically shut down.</p> <p>To clear the protection mode, press and hold the POWER button for 10 seconds.</p>
TEMP light is solid amber	<p>The projector has overheated. The display automatically shuts down. Turn the display on again after the projector cools down. If the problem persists, contact Dell.</p>
TEMP light is blinking amber	<p>If the projector fan fails, the projector will automatically shut down. Try to clear the projector mode by pressing and holding the Power button for 10 seconds. Please wait for about 5 minutes and try to power up again. If the problem persists, contact Dell.</p>
The remote control is not operating smoothly or works only within a limited range	<p>The battery may be low. If so, replace with two new AAA batteries.</p>
LAN control support	<ul style="list-style-type: none"> • Web Control functions were verified on IE9, IE10, and IE11. The other version may have compatibility problem. • The Compatibility View setting should be disabled. Otherwise the web control page may have icon or content display abnormal issue.

Guiding Signals

Projector Status	Description	Control Buttons		Indicator	
		Power	TEMP (Amber)	LAMP (Amber)	
Standby mode	Projector in Standby mode. Ready to power on.	White Flashing	OFF	OFF	OFF
Warming up mode	Projector takes some time to warm up and power on.	White	OFF	OFF	OFF
Lamp on	Projector in Normal mode, ready to display an image.  Note: The OSD menu is not accessed.	White	OFF	OFF	OFF
Cooling mode	Projector is cooling to shutdown.	White	OFF	OFF	OFF
Projector overheated	Air vents might be blocked or ambient temperature may be above 40°C. The projector automatically shuts down. Ensure that the air vents are not blocked and that the ambient temperature is within operational range. If the problem persists, contact Dell.	OFF	AMBER	OFF	OFF
Fan breakdown	One of the fans has failed. The projector automatically shuts down. If the problem persists, contact Dell.	OFF	AMBER Flashing	OFF	OFF
Lamp driver breakdown	The lamp driver has failed. The projector automatically shuts down. Unplug the power cord after three minutes and then turn the display on again. If this problem persists, contact Dell.	AMBER Flashing	OFF	OFF	AMBER Flashing
Color Wheel breakdown	Color wheel cannot start. The projector has failed and the projector automatically shuts down. Unplug the power cord after three minutes and then turn on the projector. If this problem persists, contact Dell.	White	AMBER Flashing	OFF	AMBER Flashing
Lamp failure	Lamp is defective. Replace the lamp.	OFF	OFF	OFF	AMBER
Fault - DC supply (+12V)	Power supply has been interrupted. The projector automatically shuts down. Unplug the power cord after three minutes and then turn on the projector. If this problem persists, contact Dell.	AMBER Flashing	AMBER	OFF	AMBER
Lamp module connection failed	Lamp module connection may be disrupted. Check the lamp module and ensure that it is properly installed. If the problem persists, contact Dell.	OFF	OFF	OFF	AMBER Flashing

4

Maintenance

Changing the Lamp

△ CAUTION: Before you begin any of the procedures in this section, follow the Safety Instructions as described on page 7.

Replace the lamp when the message "Lamp is approaching the end of its useful life in the operation. Replacement suggested! www.dell.com/lamps" appears on the screen. If this problem persists after replacing the lamp, contact Dell.

△ CAUTION: Use an original lamp to ensure safe and optimal working condition of your projector.

△ CAUTION: The lamp becomes very hot when in use. Do not attempt to replace the lamp until the projector has been allowed to cool down for at least 30 minutes.

△ CAUTION: Do not touch the bulb or the lamp glass at any time. Projector lamps are very fragile and may shatter if touched. The shattered glass pieces are sharp and can cause injury.

△ CAUTION: If the lamp shatters, remove all broken pieces from the projector and dispose or recycle according to state, local, or federal law. For more information see www.dell.com/hg.

- 1 Turn off the projector and disconnect the power cord.
- 2 Let the projector cool for at least 30 minutes.
- 3 Loosen the screw that secures the top cover, and remove the cover.
- 4 Loosen the screw that secures the lamp.
- 5 Pull the lamp up by its metal handle.

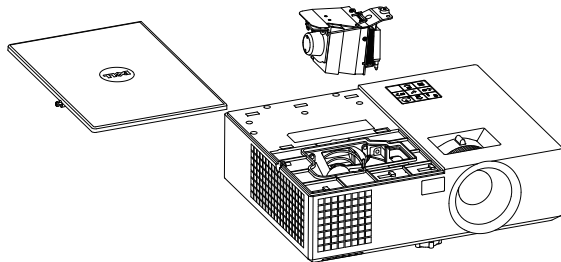



NOTE: Dell may require lamps replaced under warranty to be returned to Dell. Otherwise, contact your local waste disposal agency for the address of the nearest deposit site.

6 Replace with the new lamp.

7 Tighten the screw that secures the lamp.

8 Replace the top cover and tighten the screw.

9 Reset the lamp usage time by selecting "Yes" for **Lamp Reset** in the OSD **Power Settings** of the **Advanced Settings** menu. When a new lamp module has been changed, the projector will automatically detect and reset the lamp hours.



CAUTION: Lamp Disposal (for the US only)

 **LAMP(S) INSIDE THIS PRODUCT CONTAIN MERCURY AND MUST BE RECYCLED OR DISPOSED OF ACCORDING TO LOCAL, STATE, OR FEDERAL LAWS. FOR MORE INFORMATION, GO TO WWW.DELL.COM/HG OR CONTACT THE ELECTRONIC INDUSTRIES ALLIANCE AT WWW.EIAE.ORG. FOR LAMP-SPECIFIC DISPOSAL INFORMATION, CHECK WWW.LAMPRECYCLE.ORG.**

Replacing Remote Control Batteries



NOTE: Remove the batteries from the remote control when not in use.

1 Press the tab to lift the battery compartment cover.

1

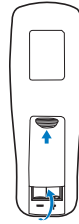

2 Check the polarity (+/-) marking on the batteries.

2

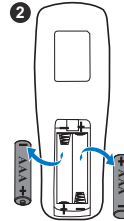

3 Insert the batteries and align their polarity correctly according to the marking in the battery compartment.

3

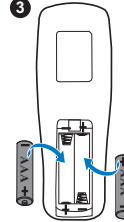

4 Slip the battery cover back.

4



5

Specifications

Light Valve	1550: 0.55" XGA S450 DMD, DarkChip3™ 1650: 0.65" WXGA S450 DMD, DarkChip3™
Brightness	1550: 3800 ANSI Lumens (Max.) 1650: 4000 ANSI Lumens (Max.)
Contrast Ratio	2200:1 Typical (Full On/Full Off)
Uniformity	1550: 85% Typical (Japan Standard - JBMA) 1650: 80% Typical (Japan Standard - JBMA)
Number of Pixels	1550: 1024 x 768 (XGA) 1650: 1280 x 800 (WXGA)
Aspect Ratio	1550: 4:3 1650: 16:9
Displayable Color	1.07 billion colors
Color Wheel Speed	2 X 1 X for 3D Display
Projection Lens	F-Stop: F/2.4~2.66 Focal length, f=18.2~21.8 mm 1.2X manual Zoom Lens 1550: Throw ratio =1.6~1.92 wide and tele 1650: Throw ratio =1.28~1.536 wide and tele 1550: Offset ratio: 115 ± 5% 1650: Offset ratio: 112.4 ± 5%
Projection Screen Size	1550: 33 ~ 310 inches (diagonal) 1650: 42 ~ 370 inches (diagonal)
Projection Distance	1550: 51 ~ 397 inches (129 ~ 1008 cm) 1650: 54 ~ 402 inches (138 ~ 1020 cm)

Video Compatibility	<p>Composite Video:</p> <p>NTSC: M (3.58 MHz), 4.43 MHz</p> <p>PAL: B, D, G, H, I, M, N, 4.43 MHz</p> <p>SECAM: B, D, G, K, K1, L, 4.25/4.4 MHz</p> <p>Component Video input via VGA: 1080i (50/60 Hz), 720p (50/60 Hz), 576i/p, 480i/p</p> <p>HDMI input: 1080p, 720p, 576i/p, 480i/p</p>
Power Supply	Universal AC 100-240 V 50-60 Hz with PFC input
Power Consumption	<p>Normal mode: 315 W \pm 10% @ 110 Vac</p> <p>Eco mode: 250 W \pm 10% @ 110 Vac</p> <p>Standby mode: < 0.5 W</p> <p>Network standby: < 3 W</p> <p> NOTE: By default, the projector is set to enter power saving mode after 20 minutes of no activity.</p>
Audio	1 speaker x 10 watt RMS
Noise Level	<p>Normal mode: 37 dB(A)</p> <p>Eco mode: 32 dB(A)</p>
Projector Weight	<7.71 lbs (3.5 Kg)
Dimensions (W x H x D)	12.6 x 3.74 x 9.84 inches (320 x 95 x 250 mm)

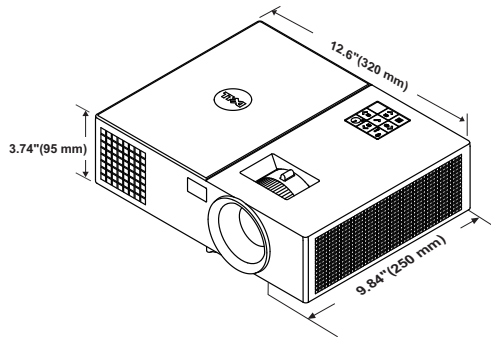

Environmental	<p>Operating temperature: 5 °C - 40 °C (41 °F-104 °F)</p> <p>Humidity: 80% maximum</p> <p>Storage temperature: 0 °C to 60 °C (32 °F to 140 °F)</p> <p>Humidity: 90% maximum</p> <p>Shipping temperature: -20 °C to 60 °C (-4 °F to 140 °F)</p> <p>Humidity: 90% maximum</p>
I/O Connectors	<p>Power: One AC power socket (3-pin - C14 inlet)</p> <p>VGA input: One 15-pin D-sub connector (Blue), VGA In, for analog RGB/Component input signals.</p> <p>VGA output: One 15-pin D-sub connector (Black) for VGA In loop through.</p> <p>Composite Video input: One Yellow RCA jack for CVBS signal.</p> <p>HDMI input: Two HDMI connectors for supporting HDMI 1.4a. specification HDCP compliant.</p> <p>Analog Audio input: One 3.5 mm stereo mini phone jack (Blue).</p> <p>Variable audio output: One 3.5 mm stereo mini phone jack (Green).</p> <p>USB (type B) port: One mini USB slave for firmware upgrade.</p> <p>5V/1.8A output: One USB type A 5V DC / 1.8 A output for support dongle power.</p> <p>RS232 port: One 9-pin D-sub for RS232 communication.</p> <p>RJ-45 port: One RJ-45 connector for build-in for network control.</p>
Lamp Lamp life	<p>PHILIPS 260 W user-replaceable lamp</p> <p>Normal mode: Up to 3000 hours</p> <p>Eco mode: Up to 5000 hours</p>



NOTE: The lamp life rating for any projector is a measure of brightness degradation only, and is not a specification for the time it takes a lamp to fail and cease light output. Lamp life is defined as the time it takes for more than 50 percent of a lamp sample population to have brightness decrease by approximately 50 percent of the rated lumens for the specified lamp. The lamp life rating is not guaranteed in any way. The actual operating life span of a projector lamp will vary according to operating conditions and usage patterns. Usage of a projector in stressful conditions which may include dusty environments, under high temperatures, many hours per day, and abrupt powering-off will most likely result in a lamp's shortened operating life span or possible lamp failure.

6

Additional Information

For additional information on how to use your projector, please see the **Dell Projectors User Guide** at www.dell.com/support/manuals.

7

Contacting Dell

For customers in the United States, call 800-WWW-DELL (800-999-3355).



NOTE: If you do not have an active Internet connection, you can find contact information on your purchase invoice, packing slip, bill, or Dell product catalog.

Dell provides several online and telephone-based support and service options. Availability varies by country and product, and some services may not be available in your area. To contact Dell for sales, technical support, or customer service issues:

- 1 Visit go to www.dell.com/contactDell.
- 2 Select your region on the interactive map.
- 3 Select a Segment for Contact.
- 4 Select the appropriate service or support link based on your need.

Index

A

- Adjusting Projector Focus 13
- Adjusting the Projected Image
 - Adjusting the Projector Height 12
 - lower the projector
 - Fixed rubber foot 12
 - Front tilt adjustment wheel 12
- Adjusting the Projector Zoom and Focus
 - Focus ring 13
 - Zoom tab 13

C

- Changing the Lamp 24
- Connection Ports
 - + 5V/1A DC out connector 6
 - Audio input connector 6
 - Audio output connector 6
 - Composite Video connector 6
 - HDMI-1 connector 6
 - HDMI-2 connector 6
 - Mini USB (mini type B) connector for firmware upgrade 6
 - Power cord connector 6
 - RJ-45 connector 6
 - RS232 connector 6

- Security cable slot 6
- VGA input connector 6
- VGA output (monitor loop through) connector 6

Contact Dell 4, 24

D

- Dell
 - contacting 31, 32

M

- Main Unit 5
 - 10W speaker 5
 - Focus ring 5
 - IR receivers 5
 - Lamp cover 5
 - Lens 5
 - Mounting holes for ceiling mount 5
 - Power button 5
 - Status indicators 5
 - Tilt adjustment wheel 5
 - Zoom tab 5

P

- phone numbers 32

R

Remote Control 8

S

Specifications

- Aspect Ratio 27
- Audio 28
- Brightness 27
- Color Wheel Speed 27
- Contrast Ratio 27
- Dimensions 28
- Displayable Color 27
- Environmental 29
- I/O Connectors 29
- Light Valve 27
- Noise Level 28
- Number of Pixels 27
- Power Consumption 28
- Power Supply 28
- Projection Distance 27
- Projection Lens 27
- Projection Screen Size 27
- Projector Weight 28
- Uniformity 27
- Video Compatibility 28

support

- contacting Dell 31, 32

T



telephone numbers 32

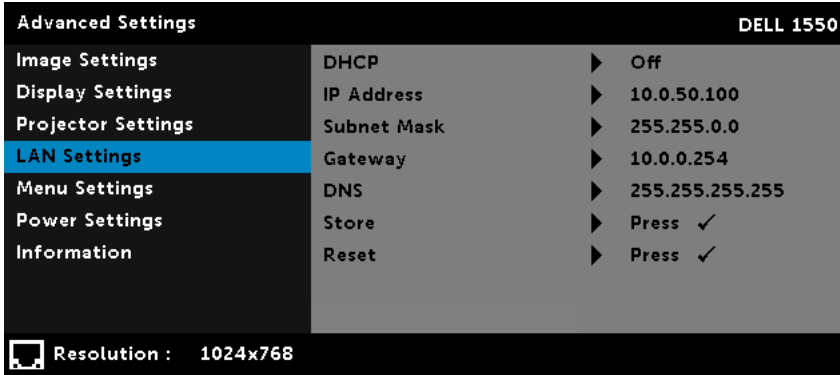

LAN Settings

LAN SETTINGS — Select and press  to activate LAN settings. The LAN settings menu provides the following options:



DHCP — If a DHCP server exists in the network to which the projector is connected, the IP address will automatically be acquired when you select DHCP On. If DHCP is Off, manually set the IP Address,

Subnet Mask, and Gateway. Use  and  to select the number of IP address, Subnet Mask, and

Gateway. Key in enter to confirm each number and then use  and  to set the next item.

IP ADDRESS — Automatically or manually assigns the IP address to the projector connected to the network.







SUBNET MASK — Configure the Subnet Mask of the network connection.



GATEWAY — Check the Gateway address with your network/system administrator if you configure it manually.

DNS — Check the DNS Server IP address with your network/system administrator if you configure it manually.

STORE — Press  to save the changes made in network configuration settings.

NOTE:

1. Use  and  buttons to select IP Address, Subnet Mask, Gateway, DNS, and Store.
2. Press the  button to enter IP Address, Subnet Mask, Gateway, or DNS to set the value (The selected option is highlighted in blue).
 - a. Use  and  buttons to select the option.
 - b. Use  and  buttons to set the value.

- c. After the setup is complete, press the  button to exit.
3. After the **IP Address, Subnet Mask, Gateway, and DNS** is set up, select **Store** and press  button to store the settings.
4. If you select **Store** without pressing the **Enter** button, the system will keep the original settings.
- RESET** — Press  to reset network configuration.

Power Saving Settings

POWER SETTINGS — Select and press  to activate power settings. The power settings menu provides the following options:

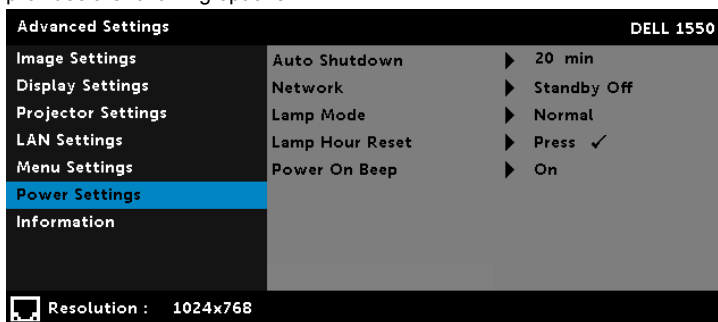

AUTO SHUTDOWN — By default, the projector is set to enter auto shutdown mode after 20 minutes of no activity. A warning message appears on screen showing a 60 seconds countdown before switching to auto shutdown mode. Press any button during the countdown period to stop the auto shutdown mode.

You can also set a different delay period to enter auto shutdown mode. The delay period is the time you want the projector to wait without an input signal.

If an input signal is not detected during the delay period, the projector turns off. To turn on the projector press the Power button.

NETWORK — Select Standby On or Off set the network on/off while the projector is standby status (default is Network Off).

LAMP MODE — Allows you to select the **Normal** or **ECO** mode.

Normal mode operates at full power level. ECO mode operates at a lower power level which may provide longer lamp life, quieter operation, and dimmer luminance output on the screen.

LAMP HOUR RESET — Press  and select the Confirm option to reset the lamp hour.

POWER ON BEEP — Select On to enable the power on beep. Select Silent to disable the power on beep.

LAN Control

Enable LAN on Projector

1. Connect the power cable and press the power button.

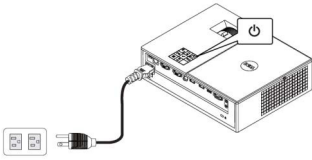

2. Press the Menu button on your projector control panel or remote control.

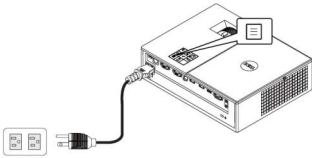

NOTE: Use , , , and  buttons to navigate and  to select.

3. Ensure DHCP option is Odd from LAN Settings of Advanced Settings menu.

Advanced Settings		DELL 1550
Image Settings	DHCP	▶ Off
Display Settings	IP Address	▶ 10.0.50.100
Projector Settings	Subnet Mask	▶ 255.255.0.0
LAN Settings	Gateway	▶ 10.0.0.254
Menu Settings	DNS	▶ 255.255.255.255
Power Settings	Store	▶ Press ✓
Information	Reset	▶ Press ✓

 Resolution : 1024x768

4. Connect the LAN cable to the projector and the computer.

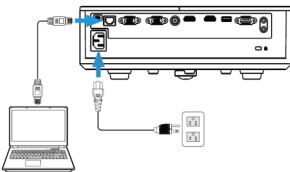

NOTE: You can also connect the LAN cable to the projector and the computer via a hub. Follow these steps to settings:

- a. DHCP option from Off change to On. Steps: Advanced Settings → LAN Settings → DHCP → On.

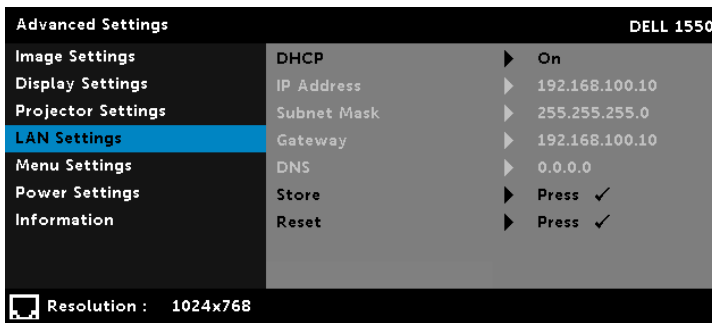

The IP address is generated via the DHCP, it is not the same.

- b. Open the Internet browser on your computer, and enter the **192.168.100.10** (as on-screen) in the browser's address bar.
 - c. Go to **Step 7**.
5. Open and enter the Internet Protocol (TCP/IP) on your computer, please enter IP address and Subnet mark, then click OK.

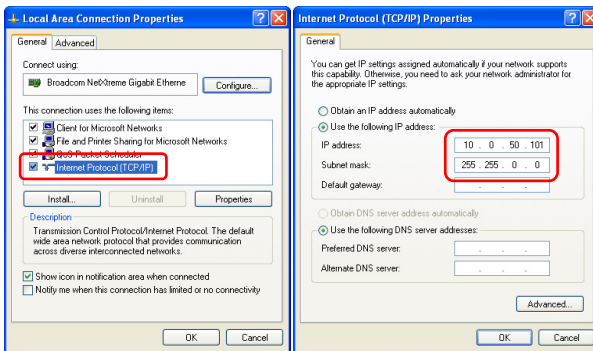

6. Open the Internet browser on your computer, and enter the 10.0.50.100 (default) in the browser's address bar. You will be directed to the **Dell 1550 Web Management** page.

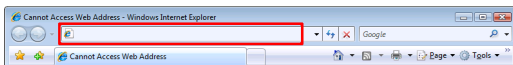

7. The Dell 1550 Web Management page opens, click **Projector Control** option.

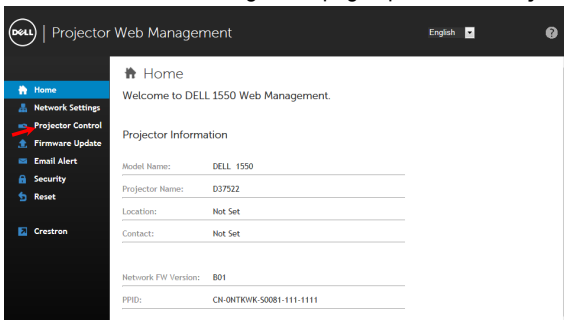

8. The Projector Control menu provide the following options:

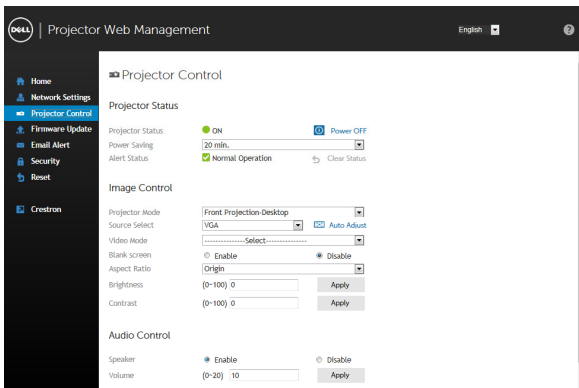

Projector Status

- **Projector Status:** Allows you to select the “Power On” or Power Off”.
- **Power Saving:** Allows you to set the power saving mode time. The default is 20 minutes.
- **Alert Status:** There are three alert states: Lamp warning, Low lamp life, and Temperature warning. Your projector might lock up in the protection mode if any of the alerts are activated. To exit the protection mode, click Clear to clear the Alert Status before you power on your projector.

Image Status

- **Projector Mode:** Allows you to select the projector mode, depending on how the projector is mounted. There are four projection modes: Front Projection-Desktop, Front Projection-Ceiling Mount, Rear Projection-Desktop, and Rear Projection-Ceiling Mount.
- **Source Select:** Allows you to select your projector’s input source. You can select VGA, Composite, HDMI-1, and HDMI-2.
- **Video Mode:** Select a mode to optimize the display image based on how the projector is being used:
 - **Presentation:** Best for presentation slides.
 - **Bright:** Maximum brightness and contrast.
 - **Movie:** For viewing movies and photos.
 - **sRGB:** Provides a more accurate color representation.
 - **Custom:** User-preferred settings.
- **Blank Screen:** Allows you to select the Enable or Disable.
- **Aspect Ratio:** Allows you to select the aspect ratio to adjust how the image appears.
- **Brightness:** Select the value (0~100) to adjust the brightness of the image.
- **Contrast:** Select the value (0~100) to adjust the display contrast.

Audio Control

- **Speaker:** Allows you to select the Enable or Disable.
- **Volume:** Select the value (0~20) for audio volume.