

Dell S2419HGF/S2719DGF

User's Guide

Monitor Model: S2419HGF/S2719DGF
Regulatory Model: S2419HGFc/S2719DGFc





NOTE: A NOTE indicates important information that helps you make better use of your computer.



CAUTION: A CAUTION indicates potential damage to hardware or loss of data if instructions are not followed.



WARNING: A WARNING indicates a potential for property damage, personal injury, or death.

Copyright © 2018 Dell Inc. or its subsidiaries. All rights reserved. Dell, EMC, and other trademarks are trademarks of Dell Inc. or its subsidiaries. Other trademarks may be trademarks of their respective owners.

2018 – 08

Rev. A00

Contents

About your monitor	6
Package contents	6
Product features	7
Identifying parts and controls	9
Front view	9
Back view	10
Side view.	11
Bottom view	11
Monitor specifications	14
Resolution specifications	15
Supported video modes	15
Preset display modes	16
Electrical specifications.	18
Physical characteristics.	19
Environmental characteristics	21
Power management modes	22
Plug and play capability	23
LCD monitor quality and pixel policy	23
Maintenance guidelines	23
Cleaning your monitor.	23
Setting up the monitor	24
Connecting the stand	24
Connecting your monitor	26

Connecting the HDMI and USB 3.0 cable.	26
Connecting the DP cable (optional purchase)	27
Organizing cables	28
Removing the stand	29
Operating your monitor	31
Power on the monitor	31
Using the control buttons	31
OSD controls	33
Using the On-Screen Display (OSD) menu	34
Accessing the OSD menu	34
OSD warning messages	47
Setting up your monitor	50
Setting the maximum resolution	50
If you have a Dell desktop or a Dell portable computer with internet access	50
If you have a non Dell desktop, portable computer, or graphics card	51
Using tilt	52
Troubleshooting	53
Self-Test	53
Built-in diagnostics	54
Common problems	55
Product-specific problems	58
Appendix.	59
Safety Instructions.	59



FCC notices (U.S. Only) and other regulatory information.
..... **59**

Contacting Dell. **59**





About your monitor



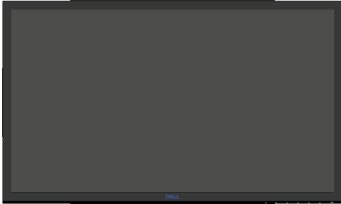
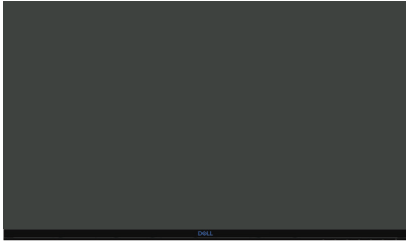

Package contents

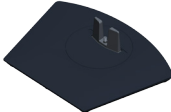
Your monitor ships with the components shown below. Ensure that you have received all the components and see [Contacting Dell](#) for more information if something is missing.

 **NOTE: Some items may be optional and may not ship with your monitor. Some features or media may not be available in certain countries.**

	Monitor (S2419HGF)
	Monitor (S2719DGF)
	Stand riser
	Stand base



	<p>Power cable (varies by countries)</p>
	<p>HDMI cable (connect this to HDMI 2.0 port to enable 144Hz high refresh rate)</p>
	<p>USB 3.0 upstream cable (enables the USB ports on the monitor)</p>
	<ul style="list-style-type: none"> • Quick Setup Guide • Safety and Regulatory Information

Product features

The **Dell S2419HGF/S2719DGF** monitor has an active matrix, Thin-Film Transistor (TFT), Liquid Crystal Display (LCD), anti-static, and LED backlight. The monitor features include:

- **S2419HGF:** 60.97 cm (24 inch) viewable area display (measured diagonally). 1920 x 1080 resolution, plus full-screen support for lower resolutions.
- **S2719DGF:** 68.47 cm (27 inch) viewable area display (measured diagonally). 2560 x 1440 resolution, plus full-screen support for lower resolutions.
- Dell monitors with selectable adaptive sync option (AMD FreeSync™ or No Sync), high refresh rates and a rapid response time of 1 ms.
- Digital connectivity with DisplayPort and HDMI.
- **S2419HGF:** Equipped with 1 USB upstream port and 2 USB downstream ports.
- **S2719DGF:** Equipped with 1 USB upstream port and 4 USB downstream ports.



- Plug and play capability if supported by your computer.
S2419HGF supports Freesync 40 Hz - 120 Hz and can be overclocked to 144Hz.
S2719DGF supports Freesync 40 Hz - 144 Hz (HDMI) and can be overclocked to 155 Hz through DisplayPort only.
- On-Screen Display (OSD) adjustments for ease of setup and screen optimization.
- Both monitors offers game enhanced features such as Timer, Frame Rate Counter and Dark Stabilizer in addition to enhanced game modes such as FPS (First- Person Shooter), RTS (Real-Time Strategy), RPG (Role-Playing Game), and 3 additional game modes to personalize your preferences.
- Removable stand and Video Electronics Standards Association (VESA™) 100 mm mounting holes for flexible mounting solutions.
- Tilt, swivel, pivot, and height adjustment capabilities.
- Security-lock slot.
- BFR/PVC-Reduced (Its circuit boards are made from BFR/PVC-free laminates.)
- Arsenic-Free glass and Mercury-Free for the panel only.
- High Dynamic Contrast Ratio (8,000,000:1).
- 0.3 W standby power when in the sleep mode.
- Dell Display Manager Software included.
- Energy Gauge shows the energy level being consumed by the monitor in real time.
- Optimize eye comfort with a flicker-free screen and ComfortView feature which minimizes blue light emission.
- Premium Panel Exchange for peace of mind



Identifying parts and controls

Front view

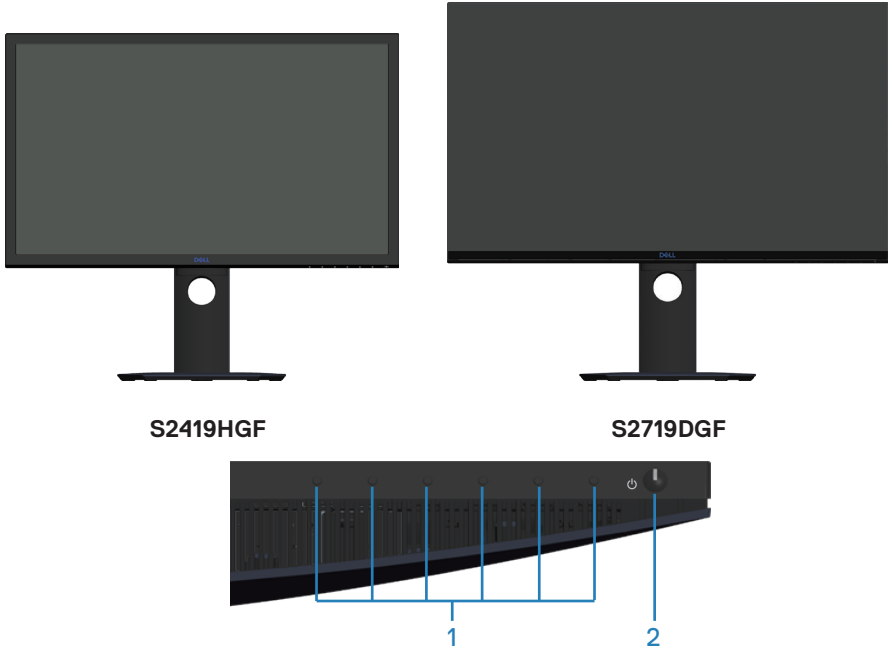

Control buttons

Label	Description	Use
1	Function buttons	Use the function buttons to adjust items in the OSD menu. (For more information, see Using the control buttons)
2	Power On/Off button	Use the power button to turn the monitor On and Off.



Back view

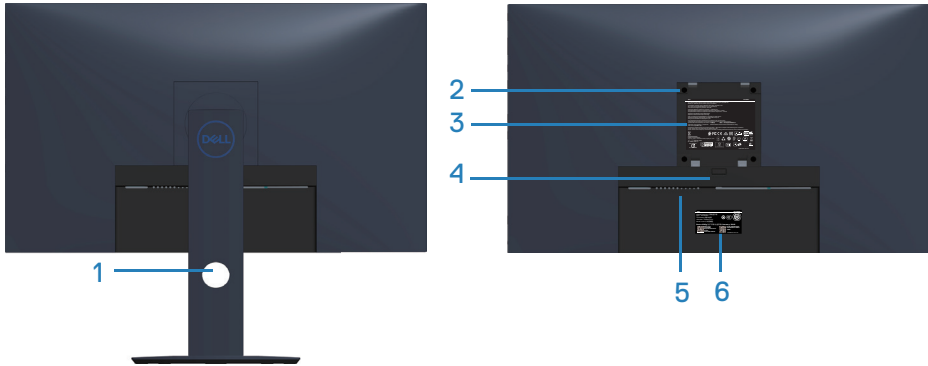

Back View with monitor stand

Label	Description	Use
1	Cable management slot	Use to organize cables by routing them through the slot.
2	VESA mounting holes (behind VESA cover)	VESA mounting holes (100 mm x 100 mm). Use for Wall mounting the monitor through a VESA-compatible wall mount kit.
3	Regulatory information label	Lists the regulatory approvals.
4	Stand release button	Releases stand from monitor.
5	Security-lock slot	Secures monitor using a security lock. Purchased separately.
6	Regulatory label (including Barcode serial number and Service Tag label)	Lists the regulatory approvals. Refer to this label if you need to contact Dell for technical support. The Service Tag is a unique alphanumeric identifier that enables Dell service technicians to identify the hardware components in your computer and access warranty information.



Side view



Bottom view

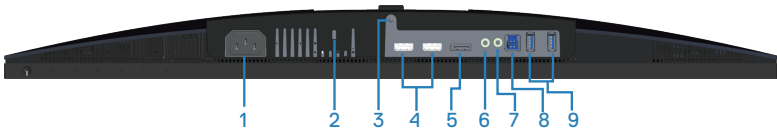

Bottom view without monitor stand (S2419HGF)

Label	Description	Use
1	Power connector	Connect the power cable (shipped with your monitor).
2	Security-lock slot	Secure your monitor using a security lock (purchased separately) to prevent unauthorized movement of your monitor.
3	Stand lock feature	To lock the stand to the monitor using a M3 x 6 mm screw (screw not included).
4	HDMI 1.4 port	Connect your computer through a HDMI cable.
5	DisplayPort 1.2	Connect your computer through a DisplayPort cable.
6	Audio line out port	Connect to either external active speakers or a sub-woofer (purchased separately).*
7	Headphone port	Connect to the headphone.



8	USB upstream port	Connect the USB cable from this port to your computer to enable the USB ports on your monitor. Disconnect the USB cable to enable USB BC1.2 charging port.
9	USB downstream ports	Connect your USB peripherals such as storage devices and printers.  NOTE: To use this port, you must connect the USB cable (shipped with your monitor) to the USB-upstream port on the monitor and to your computer.

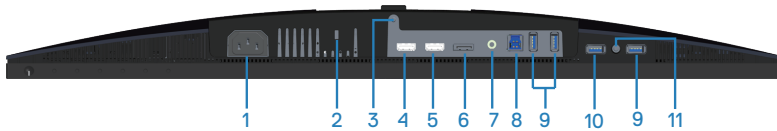

Bottom view without monitor stand (S2719DGF)

Label	Description	Use
1	Power connector	Connect the power cable (shipped with your monitor).
2	Security-lock slot	Secure your monitor using a security lock (purchased separately) to prevent unauthorized movement of your monitor.
3	Stand lock feature	To lock the stand to the monitor using a M3 x 6 mm screw (screw not included).
4	HDMI 1.4 port	Connect your computer through a HDMI cable.
5	HDMI 2.0 port	Connect your computer through a HDMI cable.
6	DisplayPort 1.2	Connect your computer through a DisplayPort cable.
7	Audio line out port	Connect to either external active speakers or a subwoofer (purchased separately).*
8	USB upstream port	Connect the USB cable from this port to your computer to enable the USB ports on your monitor.



9	USB downstream ports	<p>Connect your USB peripherals such as storage devices and printers.</p> <p> NOTE: To use this port, you must connect the USB cable (shipped with your monitor) to the USB-upstream port on the monitor and to your computer.</p>
10	USB BC1.2 charging port	Connect to charge your USB device.
11	Headphone port	Connect to the headphone.

*Headphone usage is not supported for the audio line out port.



Monitor specifications

Model	S2419HGF	S2719DGF
Screen type	Active matrix-TFT LCD	
Panel type	TN	
Viewable image		
Diagonal	609.70 mm (24 in.)	684.67 mm (27 in.)
Horizontal, Active Area	531.36 mm (20.88 in.)	596.74 mm (23.45 in.)
Vertical, Active Area	298.89 mm (11.75 in.)	335.66 mm (13.19 in.)
Area	1562.46 cm ² (242.15 in. ²)	2010.76 cm ² (311.67 in. ²)
Refresh rate		
Native	1920x1080/120Hz (HDMI 1/ HDMI 2/DP)	2560x1440/60Hz (HDMI 1) 2560x1440/144Hz (HDMI 2/DP)
Overclock	1920x1080/144Hz (HDMI 1/ HDMI 2/DP)	2560x1440/155Hz (DP)
Pixel pitch	0.27675 mm	0.2331 mm
Pixel per inch (PPI)	91	108
Viewing angle		
Horizontal	160° (typical)	
Vertical	170° (typical)	
Brightness	350 cd/m ² (typical)	
Contrast ratio	1000 to 1 (typical) 8,000,000 to 1 (Dynamic Contrast)	
Faceplate coating	Low haze with 3H hardness	
Backlight	LED edgelight system	
Response time	1 ms (G to G)	
Color depth	16.7 million colors	
Color gamut	CIE 1976 (84%), CIE 1931 (72%)	
Dell display manager compatibility	Yes	



Connectivity	Two HDMI 1.4 ports (1920 x 1080, up to 144 Hz) One DisplayPort 1.2 (1920 x 1080, up to 144 Hz)	One HDMI 1.4 ports (2560 x 1440, up to 60 Hz) One HDMI 2.0 ports (2560 x 1440, up to 144 Hz) One DisplayPort 1.2 (2560 x 1440, up to 155 Hz)
Bezel width (edge of monitor to active area)	16.6 mm (Top) 16.8 mm (Left/Right) 21.3 mm (Bottom)	6.9 mm (Top) 7.4 mm (Left/Right) 19.1 mm (Bottom)
Security	Security lock slot (cable lock optional purchase)	
Adjustability		
Height adjustable stand	130 mm	
Tilt	-5° to 21°	
Swivel	-45° to 45°	
Pivot	-90° to 90°	

Resolution specifications

Model	S2419HGF	S2719DGF
Horizontal scan range	30 kHz to 140 kHz (automatic)	30 kHz to 230 kHz (automatic)
Vertical scan range	40 Hz to 120 Hz (automatic)	40 Hz to 144 Hz (automatic)
Maximum preset resolution	1920 x 1080 at 60 Hz for HDMI 1.4 (HDCP) port.	2560 x 1440 at 60 Hz for HDMI 1.4 (HDCP) port.

Supported video modes

Model	S2419HGF/S2719DGF
Video display capabilities (HDMI)	480p, 480i, 576p, 720p, 1080p, 576i, 1080i



Preset display modes
S2419HGF

Display Mode	Horizontal Frequency (kHz)	Vertical Frequency (Hz)	Pixel Clock (MHz)	Sync Polarity (Horizontal / Vertical)
VESA, 720 x 400	31.5	70.1	28.3	-/+
VESA, 640 x 480	31.5	60.0	25.2	-/-
VESA, 640 x 480	37.5	75.0	31.5	-/-
VESA, 800 x 600	37.9	60.3	40.0	+/+
VESA, 800 x 600	46.9	75.0	49.5	+/+
VESA, 1024 x 768	48.4	60.0	65.0	-/-
VESA, 1024 x 768	60.0	75.0	78.8	+/+
VESA, 1152 x 864	67.5	75.0	108.0	+/+
VESA, 1280 x 1024	64.0	60.0	108.0	+/+
VESA, 1280 x 1024	80.0	75.0	135.0	+/+
VESA, 1600 x 900	60.0	60.0	108.0	+/+
VESA, 1920 x 1080	67.5	60.0	148.5	+/+
VESA, 1920 x 1080	274.3	119.9	137.1	+/-
VESA, 1920 x 1080	332.9	143.9	166.4	+/-



S2719DGF

Display Mode	Horizontal Frequency (kHz)	Vertical Frequency (Hz)	Pixel Clock (MHz)	Sync Polarity (Horizontal / Vertical)
VESA, 720 x 400	31.5	70.1	28.3	-/+
VESA, 640 x 480	31.5	59.9	25.2	-/-
VESA, 640 x 480	37.5	75.0	31.5	-/-
VESA, 800 x 600	37.9	60.3	40.0	+/+
VESA, 800 x 600	46.9	75.0	49.5	+/+
VESA, 1024 x 768	48.4	60.0	65.0	-/-
VESA, 1024 x 768	60.0	75.0	78.8	+/+
VESA, 1152 x 864	67.5	75.0	108.0	+/+
VESA, 1280 x 768	47.8	59.9	79.5	-/+
VESA, 1280 x 1024	64.0	60.0	108.0	+/+
VESA, 1280 x 1024	79.9	75.0	135.0	+/+
VESA, 1600 x 1200	75.0	60.0	162.0	+/+
VESA, 1680 x 1050	65.3	60.0	146.3	-/+
VESA, 1920 x 1080	67.5	60.0	148.5	+/+
VESA, 1920 x 1200	74.6	59.9	193.3	-/+
VESA, 2048 x 1080	66.6	60.0	147.2	+/-
VESA, 2560 x 1440	88.8	60.0	241.5	+/-
VESA, 2560 x 1440	586.0	143.9	222.0	+/-
VESA, 2560 x 1440 DP only	634.0	154.8	240.1	+/-



Electrical specifications

Model	S2419HGF/S2719DGF
Video input signals	HDMI 1.4 (HDCP), 600 mV for each differential line, 100 ohm input impedance per differential pair HDMI 2.0 (HDCP), 600 mV for each differential line, 100 ohm input impedance per differential pair (only for S2719DGF) DisplayPort 1.2, 600 mV for each differential line, 100 ohm input impedance per differential pair
AC input voltage/frequency/current	100 VAC to 240 VAC / 50 Hz or 60 Hz \pm 3 Hz / 1.5 A  NOTE: The AC input current needs to be 1.5 A (typical).
Inrush current	No damage when cold start at 100 VAC~240 VAC



Physical characteristics

Model	S2419HGF
Signal cable type	Digital: detachable, HDMI, 19 pins
Front-frame gloss	Black frame 2-4 gloss units
Dimensions (with stand)	
Height (extended)	498.6 mm (19.63 in.)
Height (compressed)	368.6 mm (14.51 in.)
Width	565.0 mm (22.24 in.)
Depth	177.0 mm (6.97 in.)
Dimensions (without stand)	
Height	336.8 mm (13.26 in.)
Width	565.0 mm (22.24 in.)
Depth	50.0 mm (1.97 in.)
Stand dimensions	
Height (extended)	400.8 mm (15.78 in.)
Height (compressed)	353.4 mm (13.91 in.)
Width	239.4 mm (9.43 in.)
Depth	177.0 mm (6.97 in.)
Weight	
Weight with packaging	7.55 kg (16.64 lb)
Weight with stand assembly and cables	5.29 kg (11.66 lb)
Weight without stand assembly (no cables)	3.28 kg (7.23 lb)
Weight of stand assembly	1.68 kg (3.70 lb)



Model	S2719DGF
Signal cable type	Digital: detachable, HDMI, 19 pins
Front-frame gloss	Black frame 2-4 gloss units
Dimensions (with stand)	
Height (extended)	524.8 mm (20.66 in.)
Height (compressed)	394.8 mm (15.54 in.)
Width	611.6 mm (24.08 in.)
Depth	184.4 mm (7.26 in.)
Dimensions (without stand)	
Height	361.6 mm (14.24 in.)
Width	611.6 mm (24.08 in.)
Depth	55.2 mm (2.17 in.)
Stand dimensions	
Height (extended)	418.4 mm (16.47 in.)
Height (compressed)	370.7 mm (14.60 in.)
Width	244.4 mm (9.62 in.)
Depth	184.4 mm (7.26 in.)
Weight	
Weight with packaging	9.23 kg (20.35 lb)
Weight with stand assembly and cables	6.39 kg (14.09 lb)
Weight without stand assembly (no cables)	4.27 kg (9.41 lb)
Weight of stand assembly	1.78 kg (3.92 lb)



Environmental characteristics

Model	S2419HGF	S2719DGF
Temperature		
Operating	0°C to 40°C (32°F to 104°F)	
Non-operating	<ul style="list-style-type: none"> • Storage: -20°C to 60°C (-4°F to 140°F) • Shipping: -20°C to 60°C (-4°F to 140°F) 	
Humidity		
Operating	10% to 80% (non-condensing)	
Non-operating	<ul style="list-style-type: none"> • Storage 5% to 90% (non-condensing) • Shipping 5% to 90% (non-condensing) 	
Altitude		
Operating (maximum)	5,000 m (16,400 ft)	
Non-operating (maximum)	12,192 m (40,000 ft)	
Thermal dissipation	<ul style="list-style-type: none"> • 184.38 BTU/hour (maximum) • 85.36 BTU/hour (typical) 	<ul style="list-style-type: none"> • 290.23 BTU/hour (maximum) • 119.50 BTU/hour (typical)



Power management modes

If you have VESA's DPM compliance display card or software installed in your PC, the monitor can automatically reduce its power consumption when not in use. This is referred to as Power Save Mode*. If the computer detects input from the keyboard, mouse or other input devices, the monitor automatically resumes functioning. The following table shows the power consumption and signaling of this automatic power saving feature.

* Zero power consumption in off mode can only be achieved by disconnecting the power cable from the monitor.

S2419HGF

VESA Modes	Horizontal Sync	Vertical Sync	Video	Power Indicator	Power Consumption
Normal operation	Active	Active	Active	White	54 W (maximum) 25 W (typical)
Active-off mode	Inactive	Inactive	Blanked	White (Glowing)	Less than 0.3 W
Switch off	-	-	-	Off	Less than 0.3 W

S2719DGF

VESA Modes	Horizontal Sync	Vertical Sync	Video	Power Indicator	Power Consumption
Normal operation	Active	Active	Active	White	85 W (maximum) 35 W (typical)
Active-off mode	Inactive	Inactive	Blanked	White (Glowing)	Less than 0.3 W
Switch off	-	-	-	Off	Less than 0.3 W

This document is informational only and reflects laboratory performance. Your product may perform differently, depending on the software, components and peripherals you ordered and shall have no obligation to update such information. Accordingly, the customer should not rely upon this information in making decisions about electrical tolerances or otherwise. No warranty as to accuracy or completeness is expressed or implied.



Plug and play capability

You can install the monitor in any Plug and Play-compatible system. The monitor automatically provides the computer system with its Extended Display Identification Data (EDID) using Display Data Channel (DDC) protocols so the system can configure itself and optimize the monitor settings. Most monitor installations are automatic, you can select different settings if desired. For more information about changing the monitor settings, see [Operating your monitor](#).

LCD monitor quality and pixel policy

During the LCD Monitor manufacturing process, it is not uncommon for one or more pixels to become fixed in an unchanging state which are hard to see and do not affect the display quality or usability. For more information on Dell Monitor Quality and Pixel Policy, see Dell Support site at www.dell.com/support/monitors.

Maintenance guidelines

Cleaning your monitor

 **WARNING: Before cleaning the monitor, unplug the monitor power cable from the electrical outlet.**

 **CAUTION: Read and follow the [Safety Instructions](#) before cleaning the monitor.**

For best practices, follow the instructions in the list below while unpacking, cleaning or handling your monitor:

- To clean your screen, lightly dampen a soft, clean cloth with water. If possible, use a special screen-cleaning tissue or solution suitable for the anti-static coating. Do not use benzene, thinner, ammonia, abrasive cleaners or compressed air.
- Use a lightly-dampened cloth to clean the monitor. Avoid using detergent of any kind as some detergents leave a milky film on the monitor.
- If you notice white powder when you unpack your monitor, wipe it off with a cloth.
- Handle your monitor with care as the black-colored monitor may get scratched and show white scuff marks.
- To help maintain the best image quality on your monitor, use a dynamically changing screen saver and turn off your monitor when not in use.



Setting up the monitor

Connecting the stand

 **NOTE:** The stand is detached when the monitor is shipped from the factory.

 **NOTE:** The following procedure is applicable for the stand that shipped with your monitor. If you are connecting a third-party stand, see the documentation that shipped with the stand.

To attach the monitor stand:

1. Follow the instructions on the flaps of carton to remove the stand from the top cushion that secures it.
2. Insert the stand base blocks fully into the stand slot.
3. Lift the screw handle and turn the screw clockwise.
4. After fully tightening the screw, fold the screw handle flat within the recess.

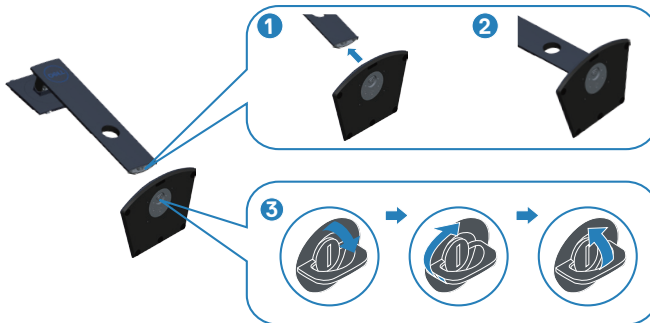

5. Attach the stand assembly to the monitor.

- Fit the two tabs on the upper part of the stand to the groove on the back of the monitor.
- Press the stand down till it snaps into place.

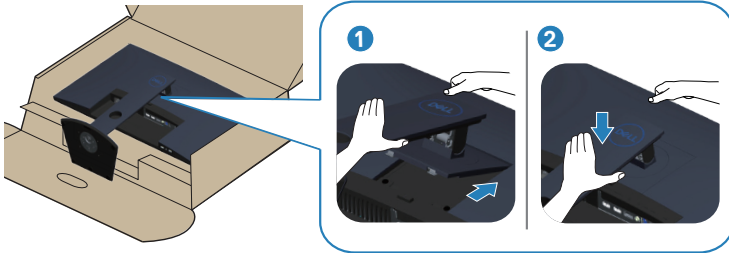

6. Place the monitor upright.



Connecting your monitor

⚠ WARNING: Before you begin any of the procedures in this section, follow the [Safety Instructions](#).

📎 NOTE: Do not connect all cables to the computer at the same time. It is recommended to route the cables through the cable-management slot before you connect them to the monitor.

To connect your monitor to the computer:

1. Turn Off your computer and disconnect the power cable.
2. Connect the HDMI or DisplayPort cable from your monitor to the computer.

Connecting the HDMI and USB 3.0 cable

S2719HGF

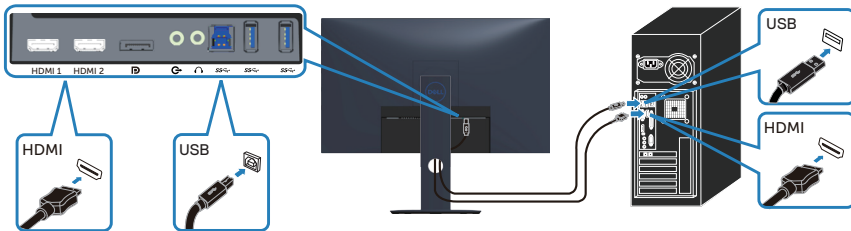

S2719DGF

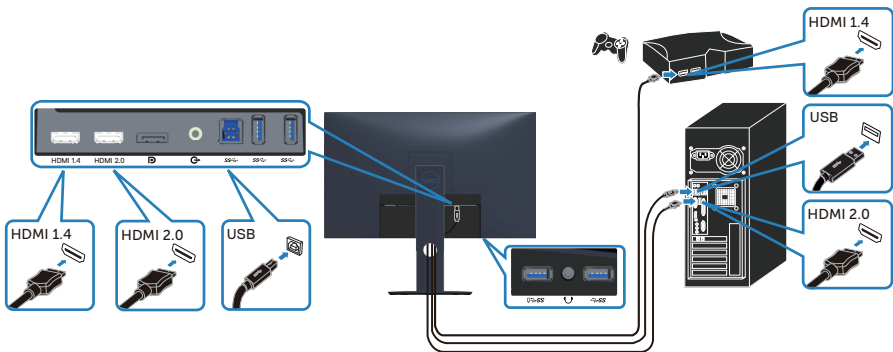

1. Connect the upstream USB 3.0 port (cable shipped with your monitor) to an appropriate USB 3.0 port on your computer. (See [Bottom view](#) for details.)
2. Connect the USB 3.0 peripherals to the downstream USB 3.0 ports on the monitor.
3. Connect the power cables from your computer and monitor into a wall outlet.

Connecting the DP cable (optional purchase) S2419HGF

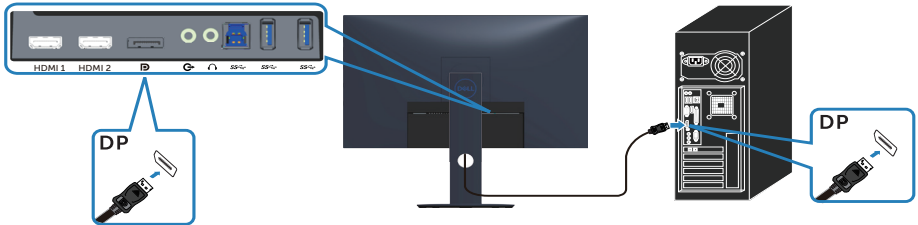

S2719DGF

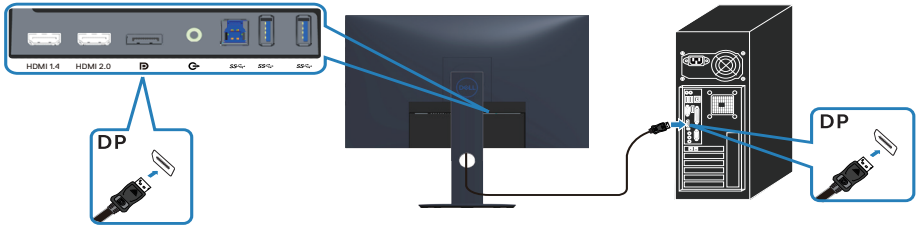

Organizing cables

Use the cable-management slot to route the cables connected to your monitor.

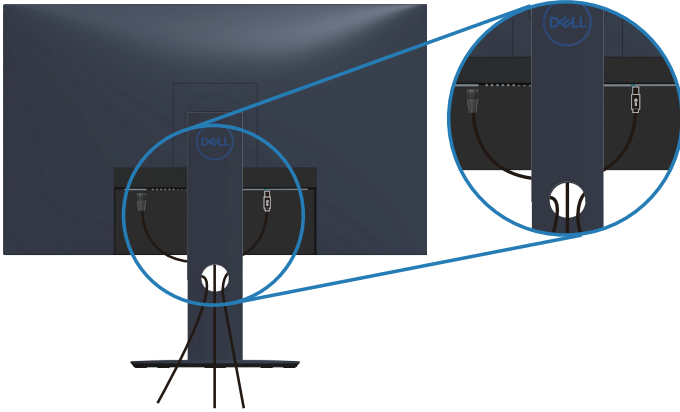

Removing the stand

- NOTE: To prevent scratches on the screen when removing the stand, ensure that the monitor is placed on a soft and clean surface.
- NOTE: The following procedure is applicable only for the stand that shipped with your monitor. If you are connecting a third-party stand, see the documentation that shipped with the stand.

To remove the stand:

1. Place the monitor on a soft cloth or cushion along the desk.

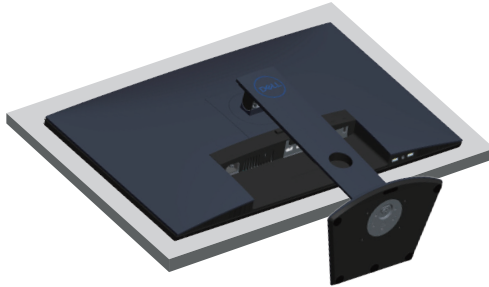

2. Press and hold the stand release button, and then lift the stand off the monitor.

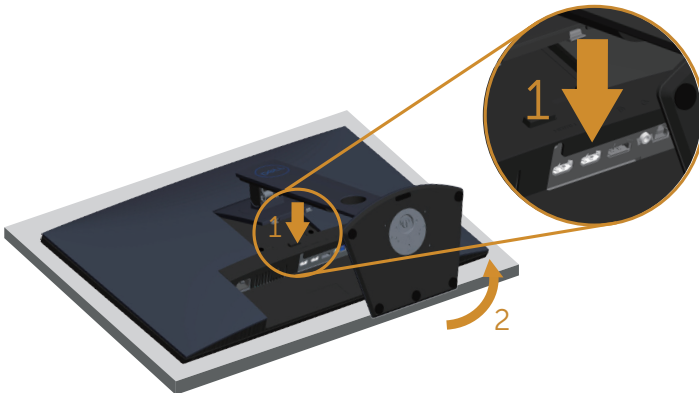

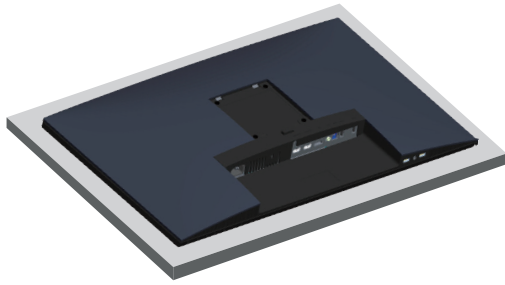

Operating your monitor

Power on the monitor

Press the  button to turn on the monitor.

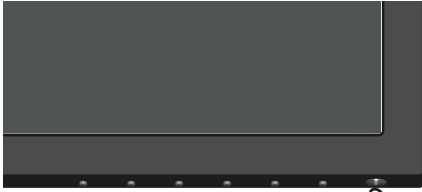

S2419HGF



S2719DGF

Using the control buttons

Use the control buttons at the bottom edge of the monitor to adjust the image being displayed.

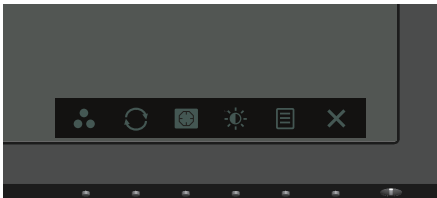

S2419HGF

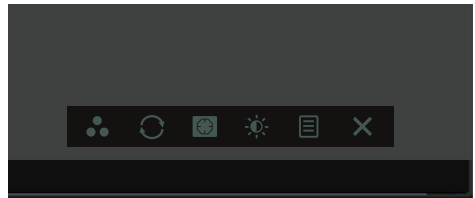



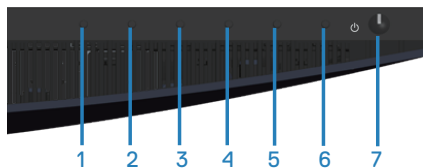



S2719DGF



Control buttons



The following table describes the control buttons:

Control Buttons	Description
1  Shortcut key/Preset Modes	Use this button to choose from a list of preset modes.
2  FreeSync	Use this button to launch the FreeSync menu.
3  Dark Stabilizer	Use this button to launch the Dark Stabilizer menu.
4  Brightness/Contrast	Use this button to activate Brightness/Contrast/Volume adjustment.
5  Menu	Use the Menu button to launch the On-Screen Display (OSD) and select the OSD Menu. See Accessing the OSD menu .
6  Exit	Use this button to go back to the main menu or exit the OSD main menu.
7  Power On/Off button (with LED indicator)	Use the Power button to turn the monitor on and off. Solid white light indicates the monitor is On and fully functional. Blinking white light indicates the power save mode.



OSD controls



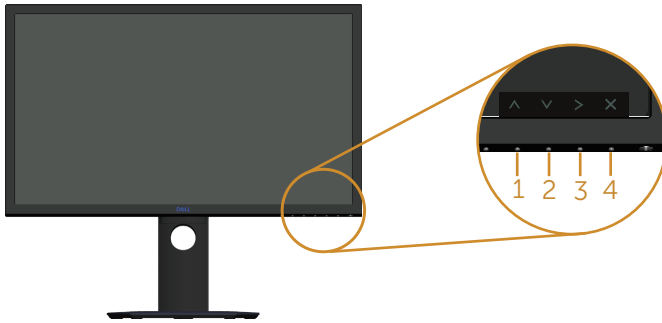

Use the buttons on the bottom of the monitor to adjust the image settings.

S2419HGF

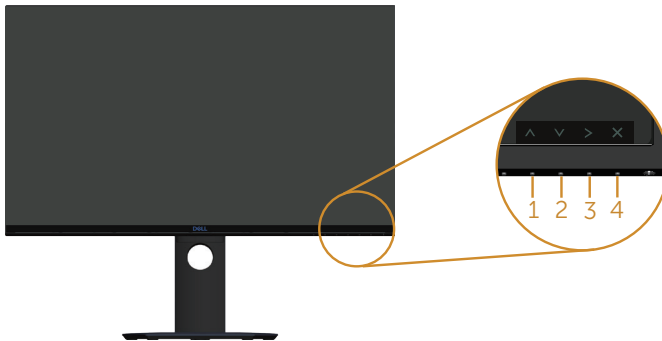

S2719DGF



	Control Buttons	Description
1	 Up	Use the Up button to increase values or move up in a menu.
2	 Down	Use the Down button to decrease values or move down in a menu.
3	 OK	Use the OK button to confirm your selection in a menu.
4	 Back	Use the Back button to go back to the previous menu.



Using the On-Screen Display (OSD) menu

Accessing the OSD menu

NOTE: Any changes you make are automatically saved when you move to another menu, exit the OSD menu, or wait for the OSD menu to automatically close.

1. Press the  button to display the OSD main menu.



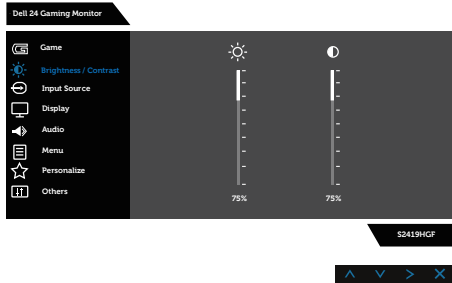

Main Menu for HDMI input

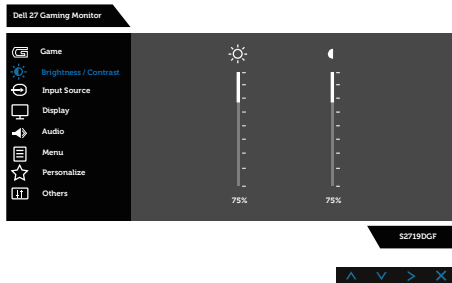

S2419HGF



S2719DGF



2. Press the  and  buttons to move between the setting options. As you move from one icon to another, the option name is highlighted. See the following table for a complete list of all the options available for the monitor.
3. Press the  button once to activate the highlighted option.
4. Press  and  button to select the desired parameter.













- Press **>** and then use the **▲** and **▼** buttons, according to the indicators on the menu, to make your changes.
- Select the **✕** button to return to the main menu.

Icon	Menu and Submenus	Description
	<p>Game</p>	<p>Use Game to adjust the Game setting mode.</p> <div data-bbox="583 391 908 592"> </div> <p>S2419HGF</p> <div data-bbox="583 646 908 847"> </div> <p>S2719DGF</p>



Preset Modes	<p>When you select preset modes, you can choose Standard, FPS, RTS, RPG, Game 1, Game 2, Game 3, ComfortView, Warm, Cool or Custom Color from the list.</p> <ul style="list-style-type: none"> • Standard: Loads the monitor's default color settings. This is the default preset mode. • FPS: Loads color settings ideal for First-Person Shooter games. • RTS: Loads color settings ideal for Real-Time Strategy games. • RPG: Loads color settings ideal for Role-Playing games. • Game 1/Game 2/Game 3: Allows you to customize the color settings for your gaming needs. • ComfortView: Decreases the level of blue light emitted from the screen to make viewing more comfortable for your eyes. • Warm: Increases the color temperature. The screen appears warmer with a red/yellow tint. • Cool: Decreases the color temperature. The screen appears cooler with a blue tint. • Custom Color: Allows you to manually adjust the color settings.
Game Enhance Mode	Adjusts Game Enhance Mode to Off, Timer, Frame Rate or Display Alignment.
Overclock	<p>Allows you to operate the monitor at a higher refresh rate than specified by the panel specification.</p> <p> NOTE: Overclocking may cause screen flickering. To reduce such effects, try to setting a lower refresh rate in the Overclock Refresh Rate menu.</p> <p> NOTE: This function is available for both HDMI & DP inputs (for S2419HGF). This function is only available for DP input (for S2719DGF).</p>
Freesync	Allows you to set the Freesync On or Off.
Response Time	User can select between Normal, Fast or Super fast.
Dark Stabilizer	The feature improves the visibility in the dark gaming scenarios. The higher the value (between 0 to 3), the better visibility in dark area of the display image.



<p>Hue</p>	<p>This feature can shift the color of the video image to green or purple. This is used to adjust the desired flesh tone color. Use  and  to adjust the hue from 0 to 100.</p> <p>Press  to increase the green shade of the video image.</p> <p>Press  to increase the purple shade of the video image.</p> <p> NOTE: Hue adjustment is available only when you select FPS, RTS, RPG mode.</p>
<p>Saturation</p>	<p>This feature can adjust the color saturation of the video image. Use  and  to adjust the saturation from 0 to 100.</p> <p>Press  to increase the monochrome appearance of the video image.</p> <p>Press  to increase the colorful appearance of the video image.</p> <p> NOTE: Saturation adjustment is available only when you select FPS, RTS, RPG mode.</p>
<p>Reset Game</p>	<p>Allows your monitor game settings to the factory settings.</p>





Brightness/ Contrast

Use this menu to activate brightness/contrast adjustment.

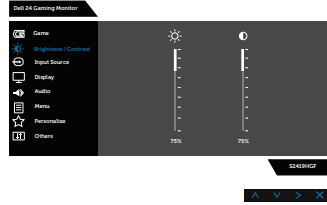

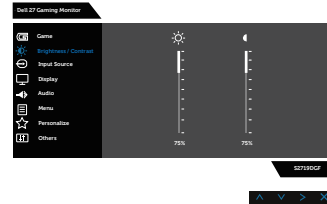

S2419HGF



S2719DGF

Brightness



Brightness adjusts the luminance of the backlight.

Press the  button to increase the brightness and press the  button to decrease the brightness (min. 0 / max. 100).

 **NOTE: Manual adjustment of brightness is disabled when dynamic contrast is switched on.**







Contrast

Adjust the brightness first, and then adjust the contrast only if further adjustment is necessary.

Press the  button to increase the contrast and press the  button to decrease the contrast (min. 0 / max. 100).

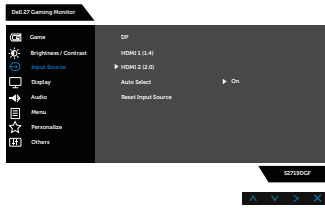
The contrast function adjusts the degree of difference between darkness and lightness on the monitor screen.



	<h3>Input Source</h3>	<p>Use the input source menu to select between the different video signals that may be connected to your monitor.</p>  <p>S2419HGF</p>  <p>S2719DGF</p>
<p>DP</p>	<p>Select DP input when you are using the DP connector. Push  to select the DP input source.</p>	
<p>HDMI 1</p>	<p>Select HDMI 1 input when you are using the HDMI 1 connector. Push  to select the HDMI 1 input source.</p>	
<p>HDMI 2</p>	<p>Select HDMI 2 input when you are using the HDMI 2 connector. Push  to select the HDMI 2 input source.</p> <p> NOTE: For S2719DGF HDMI 2 input port is version HDMI 2.0</p>	
<p>Auto Select</p>	<p>Select auto select to scan for available input signals.</p>	
<p>Reset Input Source</p>	<p>Select this option to restore default Input Source.</p>	





Display

Use the display to adjust image.

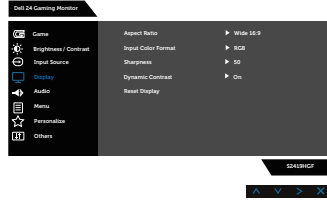

S2419HGF

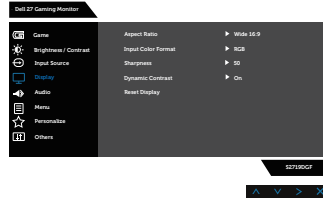

S2719DGF

Aspect Ratio

Adjusts the image ratio to Wide 16:9, 4:3 or 5:4.

Input Color Format

Allows you to set the video input mode to:

- RGB: Select this option if your monitor is connected to a computer or DVD player using the HDMI cable.
- YPbPr: Select this option if your DVD player supports only YPbPr output.

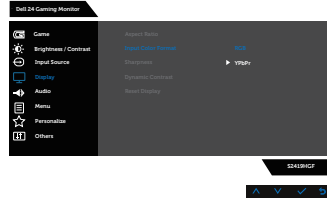



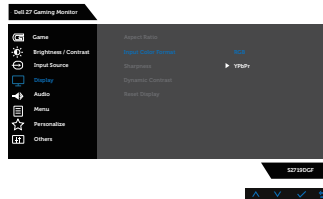

S2419HGF



S2719DGF

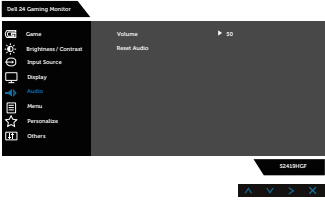
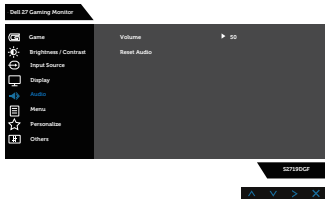

	<p>Sharpness</p>	<p>This feature can make the image look sharper or softer. Use  and  to adjust the sharpness from 0 to 100.</p> <p> NOTE: The value of 100 is sharper.</p>
	<p>Dynamic Contrast</p>	<p>Allows you to increase the level of contrast to provide sharper and more detailed image quality.</p> <p>Press the button to select the dynamic contrast on or off.</p> <p> NOTE: Dynamic contrast provides higher contrast if you select game or movie preset mode.</p>
	<p>Reset Display</p>	<p>Select this option to restore default display settings.</p>
	<p>Audio</p>	<div style="text-align: center;">  <p>S2419HGF</p>  <p>S2719DGF</p> </div>
	<p>Volume</p>	<p>Use the buttons to adjust the volume. Minimum is '0' (-). Maximum is '100' (+).</p>
	<p>Reset Audio</p>	<p>Select this option to restore default display settings.</p>





Menu

Select this option to adjust the settings of the OSD, such as, the languages of the OSD, the amount of time the menu remains on screen and so on.

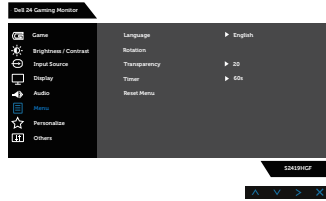

S2419HGF

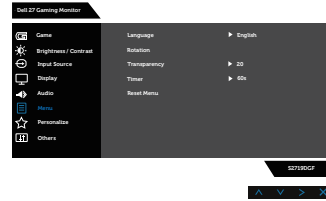

S2719DGF

Language

Language options set the OSD display to one of the eight languages (English, Spanish, French, German, Brazilian Portuguese, Russian, Simplified Chinese, or Japanese).

Rotation



Select this option to rotate the OSD.

Transparency

Select this option to change the menu transparency by pressing the  and  buttons from 0 to 100.

Timer

OSD hold time: sets the length of time the OSD will remain active after the last time you pressed a button.

Use  and  to adjust the slider in 1 second increments, from 5 to 60 seconds.

Reset Menu

Reset all OSD settings to the factory preset values.





Personalize

Users can choose a feature from Shortcut key 1, Shortcut key 2, , Shortcut key 3, Shortcut key 4, Power Button LED, USB or Reset Personalization, Preset Modes or Volume and set it as a shortcut key.

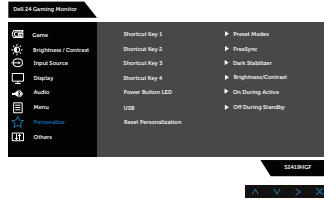

S2419HGF

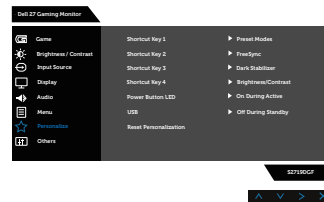

S2719DGF

Shortcut Key 1

User can select one of the following: Preset Modes, Game Enhance Mode, Overclock, Freesync, Dark Stabilizer, Brightness/Contrast, Input Source, Aspect Ratio, Volume or Rotation to set the shortcut key 1.

Shortcut Key 2

User can select one of the following: preset modes, Game Enhance Mode, Overclock, Freesync, Dark Stabilizer, brightness/contrast, input source, aspect ratio, Volume or Rotation to set the shortcut key 2.

Shortcut Key 3

User can select one of the following: preset modes, Game Enhance Mode, Overclock, Freesync, Dark Stabilizer, brightness/contrast, input source, aspect ratio, Volume or Rotation to set the shortcut key 3.

Shortcut Key 4

User can select one of the following: preset modes, Game Enhance Mode, Overclock, Freesync, Dark Stabilizer, brightness/contrast, input source, aspect ratio, Volume or Rotation to set the shortcut key 4.

Power Button LED

Allows you to set the power LED indicator On During Active or Off During Active to save energy.

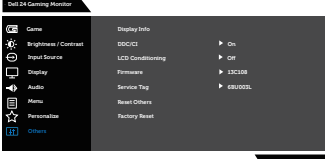
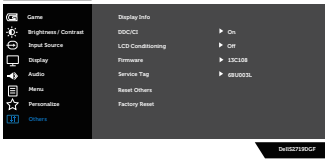
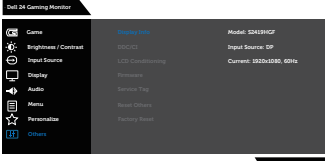
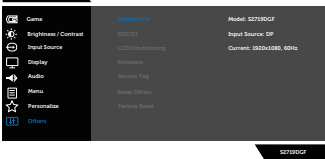

	<p>USB</p>	<p>Allows you to set the USB On During Standby or Off During Standby to save energy.</p>
	<p>Reset Personalization</p>	<p>Allows you to restore shortcut key to the default setting.</p>
	<p>Others</p>	 <p>S2419HGF</p>  <p>S2719DGF</p>
	<p>Display Info</p>	<p>Press to display the information about the display.</p>  <p>S2419HGF</p>  <p>S2719DGF</p>



DDC/CI

DDC/CI (display data channel/command interface) allows your monitor parameters (brightness, color balance and etc.) to be adjustable via the software on your computer.

You can disable this feature by selecting disable.

Enable this feature for best user experience and optimum performance of your monitor.

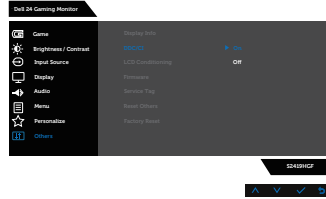

S2419HGF

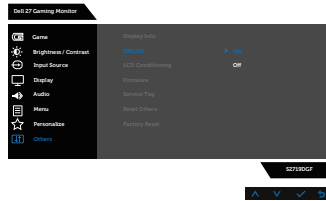

S2719DGF

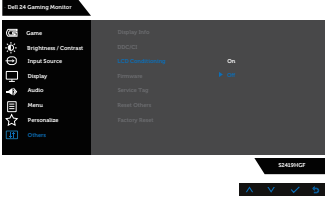
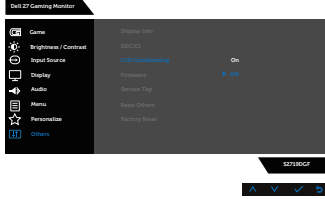

<p>LCD Conditioning</p>	<p>Helps reduce minor cases of image retention. Depending on the degree of image retention, the program may take some time to run. To start LCD conditioning, select Off.</p>  <p>S2419HGF</p>  <p>S2719DGF</p>
<p>Firmware</p>	<p>Display the version of the firmware about the display.</p>
<p>Service Tag</p>	<p>Display the service tag number of the display.</p>
<p>Reset Other</p>	<p>Reset all settings under the others setting menu to the factory preset values.</p>
<p>Factory Reset</p>	<p>Reset all settings to the factory preset values.</p>

 **NOTE: Your monitor has a built-in feature to automatically calibrate the brightness to compensate for LED aging.**



OSD warning messages

When the **Dynamic Contrast** feature is enabled (in these preset modes: **Game** or **Movie**), the manual brightness adjustment is disabled.

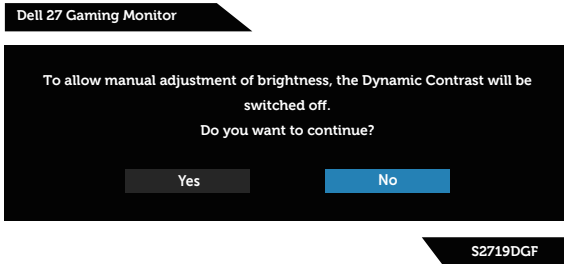
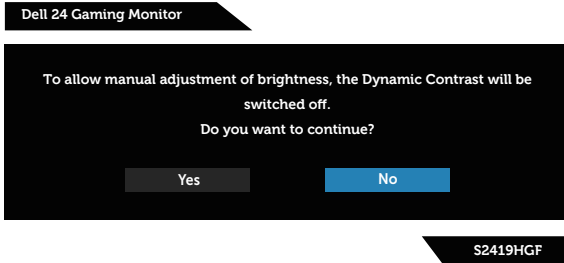

Before the **DDC/CI** function is disabled, the following message is displayed:

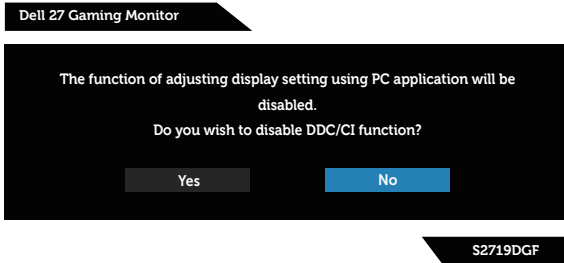
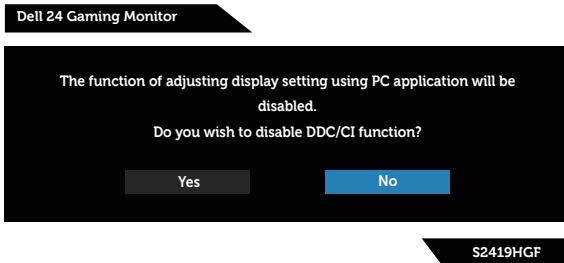

When the monitor enters the **Power Save Mode**, the following message appears:



If HDMI cable is not connected, a floating dialog box as shown below appears. The monitor will enter Power Save Mode after 4 minutes if left at this state.

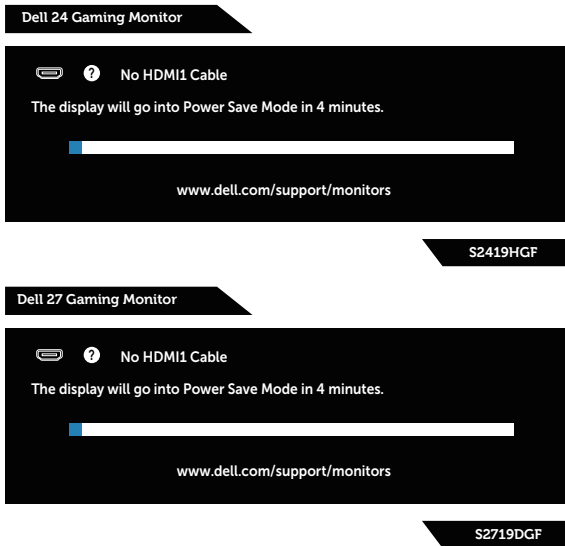

If DP cable is not connected, a floating dialog box as shown below appears. The monitor will enter Power Save Mode after 4 minutes if left at this state.

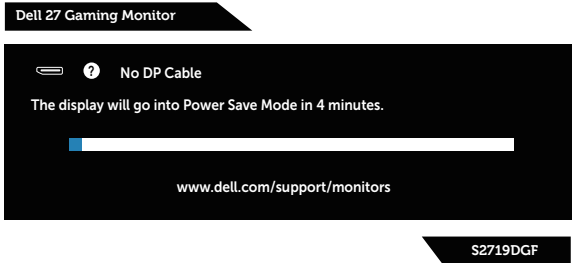
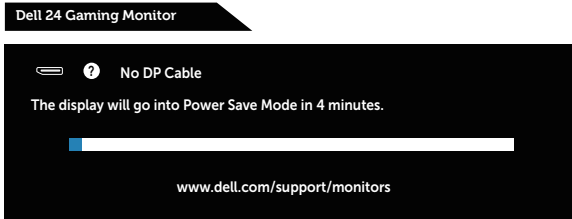

See [Troubleshooting](#) for more information.



Setting up your monitor

Setting the maximum resolution

To set the maximum resolution for the monitor:

In Windows 7, Windows 8, Windows 8.1 and Windows 10:

1. For Windows 8 and Windows 8.1 only, select the Desktop tile to switch to classic desktop.
2. Right-click on the desktop and click **Screen Resolution**.
3. Click the Dropdown list of the Screen Resolution and select **1920 x 1080** (for S2419HGF) or **2560 x 1440** (for S2719DGF).
4. Click **OK**.

If you do not see **1920 x 1080** (for S2419HGF) or **2560 x 1440** (for S2719DGF) as an option, you may need to update your graphics driver. Depending on your computer, complete one of the following procedures:

If you have a Dell desktop or portable computer:

- Go to www.dell.com/support, enter your computer's Service Tag, and download the latest driver for your graphics card.

If you are using a non-Dell computer (portable or desktop):

- Go to the support site for your computer and download the latest graphic drivers.
- Go to your graphics card website and download the latest graphic drivers.

If you have a Dell desktop or a Dell portable computer with internet access

1. Go to www.dell.com/support, enter your service tag, and download the latest driver for your graphics card.
2. After installing the drivers for your graphics adapter, attempt to set the resolution to **1920 x 1080** (for S2419HGF) or **2560 x 1440** (for S2719DGF) again.

 **NOTE: If you are unable to set the resolution to 1920 x 1080 (for S2419HGF) or 2560 x 1440 (for S2719DGF), please contact Dell to inquire about a graphics adapter that supports these resolutions.**



If you have a non Dell desktop, portable computer, or graphics card

In Windows 7, Windows 8, Windows 8.1 and Windows 10:

1. For Windows 8 and Windows 8.1 only, select the Desktop tile to switch to classic desktop.
2. Right-click on the desktop and click **Personalization**.
3. Click **Change Display Settings**.
4. Click **Advanced Settings**.
5. Identify your graphics controller supplier from the description at the top of the window (e.g. NVIDIA, ATI, Intel, and so on).
6. Refer to the graphic card provider website for updated driver (for example, www.ATI.com OR www.AMD.com).
7. After installing the drivers for your graphics adapter, attempt to set the resolution to **1920 x 1080** (for S2419HGF) or **2560 x 1440** (for S2719DGF) again.



Using tilt

 **NOTE:** The stand is not attached when the monitor is shipped from the factory.

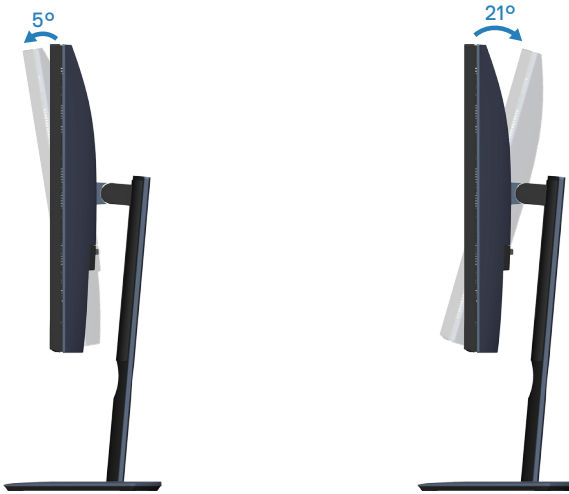

Troubleshooting

⚠ WARNING: Before you begin any of the procedures in this section, follow the [Safety Instructions](#).

Self-Test

Your monitor provides a self-test feature that allows you to check if your monitor is functioning properly. If your monitor and computer are properly connected but the monitor screen remains dark, run the monitor self-test by performing the following steps:

1. Turn off both your computer and the monitor.
2. Disconnect all video cables from the monitor. This way, the computer doesn't have to be involved.
3. Turn on the monitor.

If the monitor is working correctly, it detects that there is no signal and one of the following message appears. While in self-test mode, the power LED remains white.

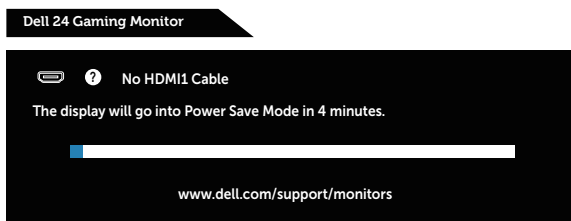

S2419HGF

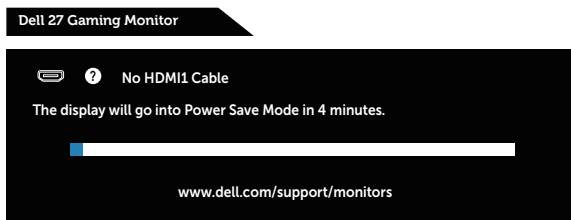

S2719DGF

✎ NOTE: This box also appears during normal system operation, if the video cable is disconnected or damaged.

4. Turn Off your monitor and reconnect the video cable; then turn on your computer and the monitor.



If your monitor remains dark after you reconnect the cables, check your video controller and computer.

Built-in diagnostics

Your monitor has a built-in diagnostic tool that helps you determine if any screen abnormality you experience is an inherent problem with your monitor, or with your computer and video card.

 **NOTE: You can run the built-in diagnostics only when the video cable is unplugged and the monitor is in self-test mode.**

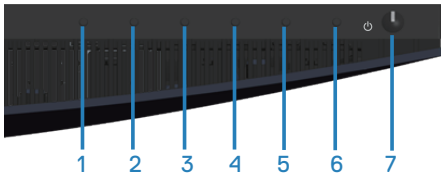

To run the built-in diagnostics:

1. Ensure that the screen is clean (no dust particles on the surface of the screen).
2. Unplug the video cable(s) from the back of the computer or monitor. The monitor then goes into the self-test mode.
3. Press and hold Button 3 for 5 seconds. A gray screen appears.
4. Carefully inspect the screen for abnormalities.
5. Press Button 3 on the bottom of the monitor again. The color of the screen changes to red.
6. Inspect the display for any abnormalities.
7. Repeat steps 5 and 6 to inspect the display in green, blue, black, white and text screens.

The test is complete when the text screen appears. To exit, press Button 3 again. If you do not detect any screen abnormalities upon using the built-in diagnostic tool, the monitor is functioning properly. Check the video card and computer.



Common problems

The following table contains general information about common monitor problems you might encounter and the possible solutions:

Common Symptoms	Possible Solutions
No Video/Power LED off	<ul style="list-style-type: none">• Ensure that the video cable connecting the monitor and the computer is properly connected and secure.• Verify that the power outlet is functioning properly using any other electrical equipment.• Ensure that the power button is pressed.• Ensure that the correct input source is selected via the Input Source menu.
No Video/Power LED on	<ul style="list-style-type: none">• Increase brightness and contrast controls using the OSD.• Perform monitor self-test feature check.• Check for bent or broken pins in the video cable connector.• Run the built-in diagnostics.• Ensure that the correct input source is selected via the Input Source menu.
Poor Focus	<ul style="list-style-type: none">• Eliminate video extension cables.• Reset the monitor to Factory Settings (Factory Reset).• Change the video resolution to the correct aspect ratio.
Shaky/Jittery Video	<ul style="list-style-type: none">• Reset the monitor to Factory Settings (Factory Reset).• Check environmental factors.• Relocate the monitor and test in another room.
Missing Pixels	<ul style="list-style-type: none">• Cycle power On-Off.• Pixel that is permanently Off is a natural defect that can occur in LCD technology.• For more information on Dell Monitor Quality and Pixel Policy, see Dell Support site at: www.dell.com/support/monitors.



Stuck-on Pixels	<ul style="list-style-type: none"> ● Cycle power On-Off. ● Pixel that is permanently off is a natural defect that can occur in LCD technology. ● For more information on Dell Monitor Quality and Pixel Policy, see Dell Support site at: www.dell.com/support/monitors.
Brightness Problems	<ul style="list-style-type: none"> ● Reset the monitor to Factory Settings (Factory Reset). ● Adjust brightness & contrast controls via OSD.
Geometric Distortion	<ul style="list-style-type: none"> ● Reset the monitor to Factory Settings (Factory Reset). ● Adjust horizontal & vertical controls via OSD.
Horizontal/Vertical Lines	<ul style="list-style-type: none"> ● Reset the monitor to Factory Settings (Factory Reset). ● Perform monitor self-test feature check and determine if these lines are also in self-test mode. ● Check for bent or broken pins in the video cable connector. ● Run the built-in diagnostics.
Synchronization Problems	<ul style="list-style-type: none"> ● Reset the monitor to Factory Settings (Factory Reset). ● Perform monitor self-test feature check to determine if the scrambled screen appears in self-test mode. ● Check for bent or broken pins in the video cable connector. ● Restart the computer in the safe mode.
Safety Related Issues	<ul style="list-style-type: none"> ● Do not perform any troubleshooting steps. ● Contact Dell immediately.
Intermittent Problems	<ul style="list-style-type: none"> ● Ensure that the video cable connecting the monitor to the computer is connected properly and is secure. ● Reset the monitor to Factory Settings (Factory Reset). ● Perform monitor self-test feature check to determine if the intermittent problem occurs in self-test mode.
Missing Color	<ul style="list-style-type: none"> ● Perform monitor self-test feature check. ● Ensure that the video cable connecting the monitor to the computer is connected properly and is secure. ● Check for bent or broken pins in the video cable connector.



Wrong Color

- Change the **Color Setting Mode** in the **Color Settings** OSD to **Graphics** or **Video** depending on the application.
- Try different **Preset Modes** in **Color** settings OSD. Adjust **R/G/B** value in **Custom Color** in **Color** settings OSD.
- Change the **Input Color Format** to **RGB** or **YPbPr** in the **Color** settings OSD.
- Run the built-in diagnostics.

Image retention from a static image left on the monitor for a long period of time

- Use the Power Management feature to turn off the monitor at all times when not in use (for more information, see [Power management modes](#)).
- Alternatively, use a dynamically changing screensaver.

Video Ghosting or Overshooting

- Change the **Response Time** in the **Display** OSD to **Fast** or **Normal** depending on your application and usage.
-



Product-specific problems

Specific Symptoms	Possible Solutions
Screen image is too small	<ul style="list-style-type: none">• Check the Aspect Ratio setting in the Display settings OSD.• Reset the monitor to Factory Settings (Factory Reset).
Cannot adjust the monitor with the buttons on the bottom of the panel	<ul style="list-style-type: none">• Turn Off the monitor, unplug the power cord, plug it back, and then turn On the monitor.• Check if the OSD menu is locked. If yes, press and hold the menu button for 10 seconds to unlock. (For more information, see Lock).
No Input Signal when user controls are pressed	<ul style="list-style-type: none">• Check the signal source. Ensure the computer is not in standby or sleep mode by moving the mouse or pressing any key on the keyboard.• Check if the video cable is plugged in properly. Disconnect and reconnect the video cable if necessary.• Reset the computer or video player.
The picture does not fill the entire screen	<ul style="list-style-type: none">• Due to different video formats (aspect ratio) of DVDs, the monitor may display in full screen.• Run the built-in diagnostics.



Appendix

Safety Instructions

-  **WARNING: Use of controls, adjustments, or procedures other than those specified in this documentation may result in exposure to shock, electrical hazards, and/or mechanical hazards.**

For information on safety instructions, see the **Safety Environment and Regulatory Information (SERI)**.

FCC notices (U.S. Only) and other regulatory information

For FCC notices and other regulatory information, see the regulatory compliance website located at www.dell.com/regulatory_compliance.

Contacting Dell

For customers in the United States, call 800-WWW-DELL (800-999-3355).

-  **NOTE: If you do not have an active Internet connection, you can find contact information on your purchase invoice, packing slip, bill, or Dell product catalog.**

Dell provides several online and telephone-based support and service options. Availability varies by country and product, and some services may not be available in your area.

To get online Monitor support content:

1. Visit www.dell.com/support/monitors.

To contact Dell for sales, technical support, or customer service issues:

1. Visit www.dell.com/support.
2. Verify your country or region in the **Choose A Country/Region** drop-down menu at the bottom of the page.
3. Click **Contact Us** on the left side of the page.
4. Select the appropriate service or support link based on your need.
5. Choose the method of contacting Dell that is convenient for you.

-  **WARNING: For displays with glossy bezels the user should consider the placement of the display as the bezel may cause disturbing reflections from surrounding light and bright surfaces.**

