

User's Guide

Dell S2218H/S2318H/S2318HX

Model No.: S2218H/S2318H/S2318HX

Regulatory model: S2218Hc/S2318Hc



Notes, Cautions, and Warnings



NOTE: A NOTE indicates important information that helps you make better use of your computer.



CAUTION: A CAUTION indicates potential damage to hardware or loss of data if instructions are not followed.



WARNING: A WARNING indicates a potential for property damage, personal injury or death.

Information in this document is subject to change without notice.

© 2017 Dell Inc. All rights reserved.

Reproduction of these materials in any manner whatsoever without the written permission of Dell Inc. is strictly forbidden.

Trademarks used in this text: *Dell* and the *DELL* logo are trademarks of Dell Inc.; *Microsoft* and *Windows* are either trademarks or registered trademarks of Microsoft Corporation in the United States and/or other countries; *Intel* is a registered trademark of Intel Corporation in the U.S. and other countries; and *ATI* is a trademark of Advanced Micro Devices, Inc. ENERGY STAR is a registered trademark of the U.S. Environmental Protection Agency. As an ENERGY STAR partner, Dell Inc. has determined that this product meets the ENERGY STAR guidelines for energy efficiency.

Other trademarks and trade names may be used in this document to refer to either the entities claiming the marks and names or their products. Dell Inc. disclaims any proprietary interest in trademarks and trade names other than its own.

Contents



About Your Monitor	5
Package Contents	5
Product Features	6
Identifying Parts and Controls	8
Plug and Play Capability.....	11
LCD Monitor Quality and Pixel Policy.....	11
Maintenance Guidelines	11
Setting Up the Monitor.....	12
Connecting the Stand	12
Connecting Your Monitor	13
Organizing Cables.....	14
Removing the Monitor Stand.....	15
Operating Your Monitor.....	16
Power On the Monitor	16
Using the Front Panel Controls	16
Using the On-Screen Display (OSD) Menu.....	19

Setting the Maximum Resolution.....	31
Using the Tilt	32
Troubleshooting.....	33
Self-Test	33
Built-in diagnostics	33
Common Problems	35
Product-Specific Problems.....	38
Appendix	39
FCC Notices (U.S. Only) and Other Regulatory Information	39
Contact Dell	39
Setting Up Your Monitor	40
Monitor Specifications	42

About Your Monitor

Package Contents

Your monitor ships with the components shown below. Ensure that you have received all the components and [Contact Dell](#) if something is missing.

-  **NOTE:** Some items may be optional and may not ship with your monitor. Some features or media may not be available in certain countries.
-  **NOTE:** To set up with any other stand, please refer to the respective stand setup guide for setup instructions.

	<ul style="list-style-type: none">• Monitor
	<ul style="list-style-type: none">• Stand riser
	<ul style="list-style-type: none">• Stand base
	<ul style="list-style-type: none">• Power Adapter
	<ul style="list-style-type: none">• Power cable (varies by countries)

	<ul style="list-style-type: none"> • HDMI Cable
	<ul style="list-style-type: none"> • VGA Cable (for S2318HX only)
	<ul style="list-style-type: none"> • Cable Holder
	<ul style="list-style-type: none"> • Quick Setup Guide • Safety and Regulatory Information

Product Features

The **Dell S2218H_S2318H_S2318HX** flat panel display has an active matrix, Thin-Film Transistor (TFT), Liquid Crystal Display (LCD), In-plane Switching panel and LED backlight. The monitor features include:

- **S2218H:** 54.61 cm (21.5 inch) viewable area display (measured diagonally). 1920 x 1080 resolution, plus full-screen support for lower resolutions.
- **S2318H/S2318HX:** 58.42 cm (23 inch) viewable area display (measured diagonally). 1920 x 1080 resolution, plus full-screen support for lower resolutions.
- Wide viewing angle to allow viewing from a sitting or standing position, or while moving from side-to-side.
- Plug and play capability if supported by your system.
- VGA and HDMI connectivity makes it simple and easy to connect with legacy and new systems.
- Build-in Speaker (3W)x2.
- On-Screen Display (OSD) adjustments for ease of set-up and screen optimization.
- Energy Star certified monitor.
- Security - lock slot.
- Capability to switch from wide aspect to standard aspect ratio while maintaining the image quality.

- TCO-Certified Displays.
- BFR/PVC-Reduced (Its circuit boards are made from BFR/PVC-free laminates).
- High Dynamic Contrast Ratio (8,000,000:1).
- 0.3 W standby power when in the sleep mode.
- Energy Gauge shows the energy level being consumed by the monitor in real time.
- Optimize eye comfort with a flicker-free screen and ComfortView feature which minimizes blue light emission.

Identifying Parts and Controls

Front View

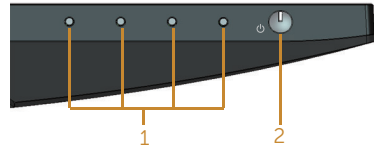

Front panel controls

Label	Description
1	Function buttons (For more information, see Operating your Monitor)
2	Power On/Off button (with LED indicator)

 **NOTE:** For displays with glossy bezels the user should consider the placement of the display as the bezel may cause disturbing reflections from surrounding light and bright surfaces.

Back View

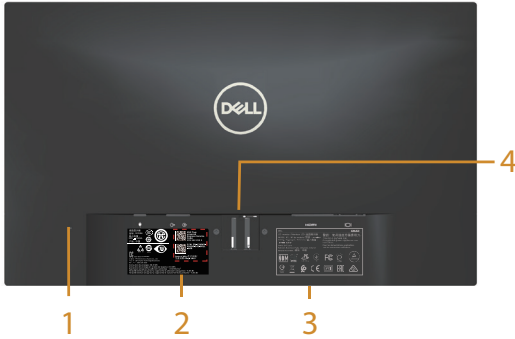

Back View without monitor stand



Back View with monitor stand

Label	Description	Use
1	Security-lock slot	Secures monitor with security lock (security lock not included).
2	Regulatory label (including Barcode serial number and Service Tag label)	Lists the regulatory approvals. Refer to this label if you need to contact Dell for technical support. The Dell service tag is used for Dell warranty and customer service management purposes and for records of the base system.
3	Regulatory information engraving.	Lists the regulatory approvals.
4	Stand release button	Releases stand from monitor.
5	Cable management slot	Uses to organize cables by placing them through the slot.

Side View

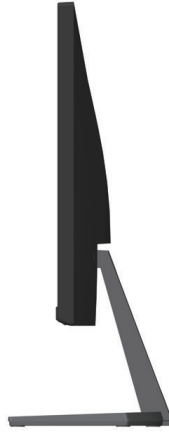

Bottom View



Bottom view without monitor stand

Label	Description	Use
1	Power-adapter port	To connect the monitor power cable using a 12V DC adapter for transition.
2	Audio Line Out port	Connect to external speakers (Optional Purchase)*
3	Audio Line In port	Connects the audio cable (Optional Purchase) from the source device to the monitor.
4	HDMI port	To connect your computer to the monitor using an HDMI cable.
5	VGA port	To connect your computer to the monitor using a VGA cable.

*Headphone usage is not supported for the audio line out port.

Plug and Play Capability

You can install the monitor in any Plug and Play-compatible system. The monitor automatically provides the computer system with its Extended Display Identification Data (EDID) using Display Data Channel (DDC) protocols so the system can configure itself and optimize the monitor settings. Most monitor installations are automatic, you can select different settings if desired. For more information about changing the monitor settings, see [Operating your Monitor](#).

LCD Monitor Quality and Pixel Policy

During the LCD Monitor manufacturing process, it is not uncommon for one or more pixels to become fixed in an unchanging state which are hard to see and do not affect the display quality or usability. For more information on Dell Monitor Quality and Pixel Policy, see Dell Support site at: www.dell.com/support/monitors.

Maintenance Guidelines

Cleaning Your Monitor

 **WARNING:** Before cleaning the monitor, unplug the monitor power cable from the electrical outlet.



 **CAUTION:** Read and follow the [Safety Instructions](#) before cleaning the monitor.

For best practices, follow the instructions in the list below while unpacking, cleaning or handling your monitor:

- To clean your anti-static screen, lightly dampen a soft, clean cloth with water. If possible, use a special screen-cleaning tissue or solution suitable for the anti-static coating. Do not use benzene, thinner, ammonia, abrasive cleaners or compressed air.
- Use a lightly-dampened, warm cloth to clean the monitor. Avoid using detergent of any kind as some detergents leave a milky film on the monitor.
- If you notice white powder when you unpack your monitor, wipe it off with a cloth.
- Handle your monitor with care as a darker-colored monitor may get scratched and show white scuff marks more than a lighter-colored monitor.
- To help maintain the best image quality on your monitor, use a dynamically changing screen saver and turn off your monitor when not in use.

Setting Up the Monitor

Connecting the Stand

-  **NOTE:** The stand is detached when the monitor is shipped from the factory.
-  **NOTE:** The following steps is applicable for a monitor with a stand.

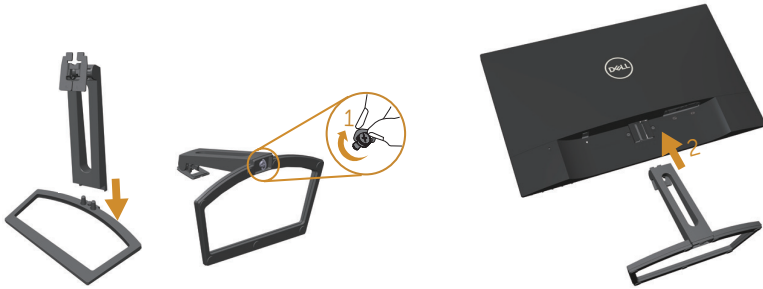

To attach the monitor stand:

1. Fit the stand riser and stand base together, and then turn the screw in the stand base.
2. Fit the two tabs on the upper part of the stand to the groove on the back of the monitor. Press the stand until it snaps into place.

Connecting Your Monitor

⚠ WARNING: Before you begin any of the procedures in this section, follow the [Safety Instructions](#).

📝 NOTE: Do not connect all cables to the computer at the same time.

To connect your monitor to the computer:

1. Turn Off your computer and disconnect the power cable.
2. Connect the VGA/HDMI/audio cable from your monitor to the computer.

Connecting the VGA cable(Optional Purchase)



Connecting the HDMI cable

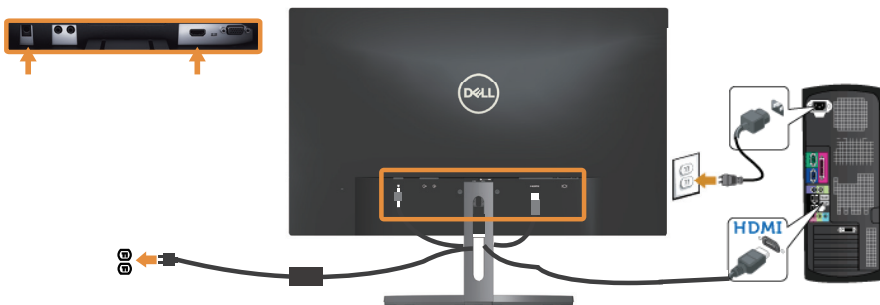

Connecting the audio cable(Optional Purchase)



Organizing Cables

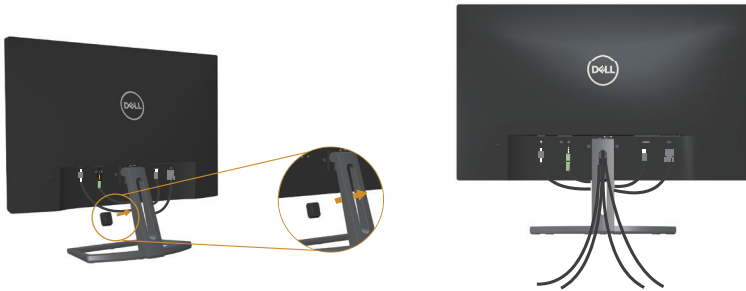

After you connect all necessary cables to your monitor and computer, organize all cables as shown above.

 **NOTE:** After the cables are connected, they will have to be disconnected again to route them through the hole.

Removing the Monitor Stand

 **NOTE:** To prevent scratches on the LCD screen while removing the stand, ensure that the monitor is placed on a soft and clean surface.

 **NOTE:** The following steps is applicable for a monitor with a stand.

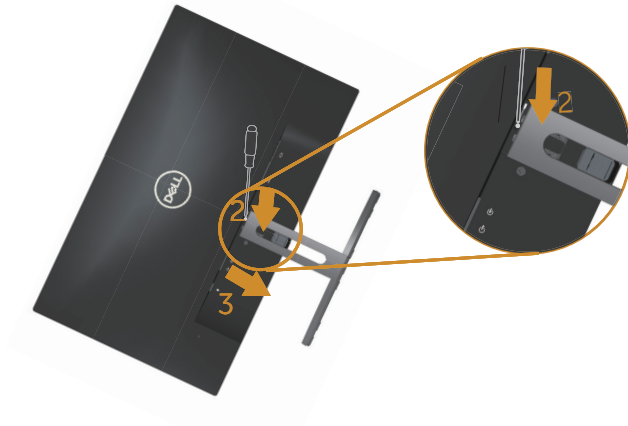

To remove the stand:

1. Place the monitor on a soft cloth or cushion.
2. Use a long and thin screwdriver to push the release latch.
3. Once the latch is released, remove the base away from monitor.

Operating Your Monitor

Power On the Monitor

Press the  button to turn On the monitor.





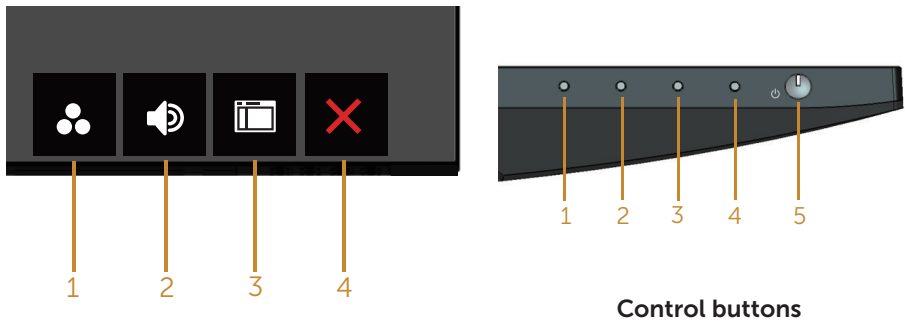

Using the Front Panel Controls

Use the control buttons on the front of the monitor to adjust the image being displayed.



The following table describes the front panel buttons:



	Front Panel Button	Description
1	 Shortcut key/Preset Modes	Use this button to choose from a list of preset modes.
	 Shortcut key/Volume	Use the buttons to adjust the volume. Minimum is '0' (-). Maximum is '100' (+).
	 Menu	Use the MENU button to launch the On-Screen Display (OSD) and select the OSD Menu. See Accessing the OSD menu .
	 Exit	Use this button to go back to the main menu or exit the OSD main menu.
2&3	 Power On/Off button (with LED indicator)	Use the Power button to turn the monitor On and Off . Solid white light indicates the monitor is On and fully functional. Blinking white light indicates the power save mode.

OSD controls

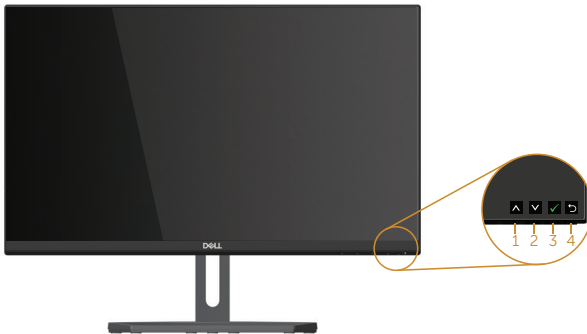
Use the buttons on the front of the monitor to adjust the image settings.





	Front Panel Button	Description
1	 Up	Use the Up button to increase values or move up.

2	 Down	Use the Down button to adjust (decrease ranges) items in the OSD menu.
3	 OK	Use the OK button to confirm your selection.
4	 Back	Use the Back button to go back to the previous menu.

Using the On-Screen Display (OSD) Menu







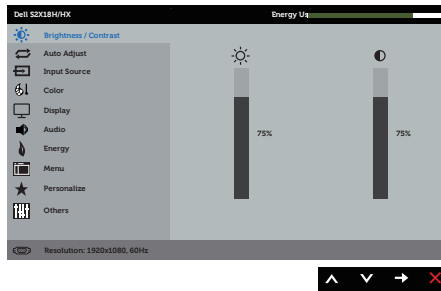

Accessing the OSD menu





 **NOTE:** If you change the settings and then either proceed to another menu or exit the OSD menu, the monitor automatically saves those changes. The changes are also saved if you change the settings and then wait for the OSD menu to disappear.



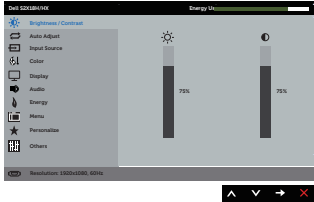

1. Press the  button to display the OSD main menu.



Main Menu for analog (VGA) input

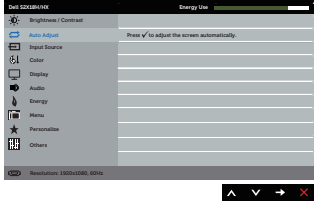

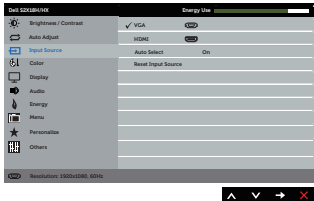



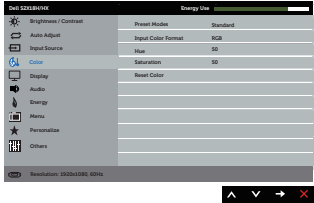

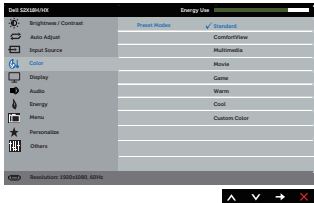

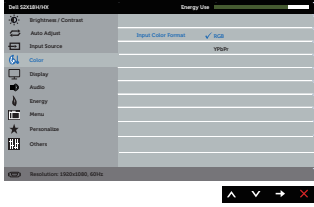

2. Press the  and  buttons to move between the setting options. As you move from one icon to another, the option name is highlighted. See the following table for a complete list of all the options available for the monitor.
3. Press the  button once to activate the highlighted option.
4. Press  and  button to select the desired parameter.
5. Press  and then use the  and  buttons, according to the indicators on the menu, to make your changes.
6. Select the  button to return to the main menu.

Icon	Menu and Submenus	Description
	Brightness/ Contrast	Use this menu to activate Brightness/Contrast adjustment. 
	Brightness	Brightness adjusts the luminance of the backlight. Press the  button to increase the brightness and press the  button to decrease the brightness (min. 0 / max. 100). NOTE: Manual adjustment of Brightness is disabled when Dynamic Contrast is switched on.
	Contrast	Adjust the Brightness first, and then adjust the Contrast only if further adjustment is necessary. Press the  button to increase the contrast and press the  button to decrease the contrast (min. 0 / max. 100). The Contrast function adjusts the degree of difference between darkness and lightness on the monitor screen.

	<h2>Auto Adjust</h2>	<p>Use this key to activate automatic setup and adjust menu.</p>  <p>The following dialog appears on a black screen as the monitor self-adjusts to the current input:</p> <div style="background-color: #cccccc; padding: 10px; text-align: center; margin: 10px 0;"> Auto Adjustment in Progress... </div> <p>Auto Adjustment allows the monitor to self-adjust to the incoming video signal. After using Auto Adjustment, you can further tune your monitor by using the Pixel Clock (Coarse) and Phase (Fine) controls under Display Settings.</p> <p>NOTE: Auto Adjust does not occur if you press the button while there are no active video input signals or attached cables.</p> <p>This option is only available when you are using the analog (VGA) connector.</p>
	<h2>Input Source</h2>	<p>Use the Input Source menu to select between the different video signals that may be connected to your monitor.</p> 
	<h3>Auto Select</h3>	<p>Select Auto Select to scan for available input signals.</p>
	<h3>VGA</h3>	<p>Select VGA input when you are using the analog (VGA) connector. Push  to select the VGA input source.</p>
	<h3>HDMI</h3>	<p>Select HDMI input when you are using the Digital (HDMI) connector. Push  to select the HDMI input source.</p>

	<h2>Color</h2>	<p>Use Color to adjust the color setting mode.</p> 
	<h2>Preset Modes</h2>	<p>When you select Preset Modes, you can choose Standard, ComfortView, Multimedia, Movie, Game, Warm, Cool or Custom Color from the list.</p> <ul style="list-style-type: none"> • Standard: Loads the monitor's default color settings. This is the default preset mode. • ComfortView: Decreases the level of blue light emitted from the screen to make viewing more comfortable for your eyes. • Multimedia: Loads color settings ideal for multimedia applications. • Movie: Loads color settings ideal for movies. • Game: Loads color settings ideal for most gaming applications. • Warm: Increases the color temperature. The screen appears warmer with a red/yellow tint. • Cool: Decreases the color temperature. The screen appears cooler with a blue tint. • Custom Color: Allows you to manually adjust the color settings. <p>Press the  and  buttons to adjust the three colors (R, G, B) values and create your own preset color mode.</p> 

<p>Input Color Format</p>	<p>Allows you to set the video input mode to:</p> <ul style="list-style-type: none"> • RGB: Select this option if your monitor is connected to a computer or DVD player using the HDMI cable. • YPbPr: Select this option if your DVD player supports only YPbPr output. 
<p>Hue</p>	<p>This feature can shift the color of the video image to green or purple. This is used to adjust the desired flesh tone color. Use  or  to adjust the hue from 0 to 100.</p> <p>Press  to increase the green shade of the video image.</p> <p>Press  to increase the purple shade of the video image.</p> <p> NOTE: Hue adjustment is available only when you select Movie or Game preset mode.</p>
<p>Saturation</p>	<p>This feature can adjust the color saturation of the video image. Use  or  to adjust the saturation from '0' to '100'.</p> <p>Press  to increase the monochrome appearance of the video image.</p> <p>Press  to increase the colorful appearance of the video image.</p> <p> NOTE: Saturation adjustment is available only when you select Movie or Game preset mode.</p>
<p>Reset Color</p>	<p>Allows your monitor color settings to the factory settings.</p>



Display

Use the Display to adjust image.

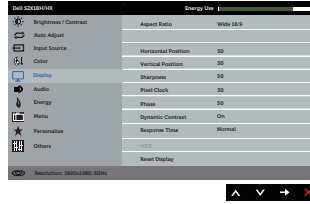

Aspect Ratio

Adjusts the image ratio to Wide 16:9, 4:3 or 5:4.

Horizontal Position

Use or the buttons to adjust image left and right. Minimum is '0' (-). Maximum is '100' (+).

Vertical Position

Use the or buttons to adjust image up and down. Minimum is '0' (-). Maximum is '100' (+).

Sharpness

This feature can make the image look sharper or softer. Use or to adjust the sharpness from '0' to '100'.

Pixel Clock

The Phase and Pixel Clock adjustments allow you to adjust your monitor to your preference. Use or buttons to adjust for best image quality. Minimum is '0' (-). Maximum is '100' (+).

Phase

If satisfactory results are not obtained using the Phase adjustment, use the Pixel Clock (coarse) adjustment and then use Phase (fine), again. Minimum is '0' (-). Maximum is '100' (+).

Dynamic Contrast

Allows you to increase the level of contrast to provide sharper and more detailed image quality.

Press the button to select the Dynamic Contrast "On" or "Off".



NOTE: Dynamic Contrast provides higher contrast if you select Game or Movie preset mode.





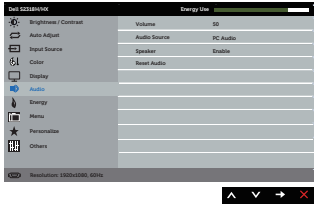

Response Time

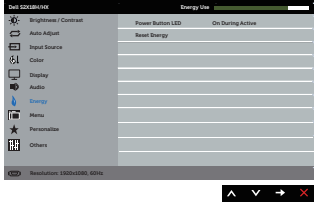

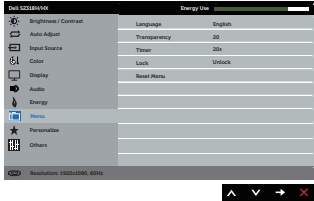
User can select between Fast or Normal.

Reset Display

Select this option to restore default display settings.

	Audio	
	Volume	Use the buttons to adjust the volume. Minimum is '0' (-). Maximum is '100' (+).
	Audio Source	Allows you to set the Audio Source mode to: <ul style="list-style-type: none"> • PC Audio • HDMI
	Speaker	Allows you to enable or disable speaker function.
	Reset Audio	Select this option to restore default display settings.
	Energy	
	Power Button LED	Allows you to set the power LED indicator On During Active or Off During Active to save energy.
	Reset Energy	Select this option to restore default Energy settings.

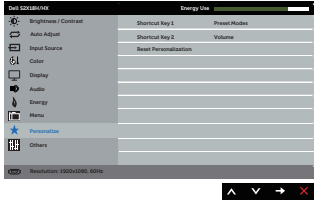
	<p>Menu</p>	<p>Select this option to adjust the settings of the OSD, such as, the languages of the OSD, the amount of time the menu remains on screen and so on.</p> 
	<p>Language</p>	<p>Language options set the OSD display to one of the eight languages (English, Spanish, French, German, Brazilian Portuguese, Russian, Simplified Chinese, or Japanese).</p>
	<p>Transparency</p>	<p>Select this option to change the menu transparency by pressing the  and  buttons from 0 to 100.</p>
	<p>Timer</p>	<p>OSD Hold Time: sets the length of time the OSD will remain active after the last time you pressed a button.</p> <p>Use  or  to adjust the slider in 1 second increments, from 5 to 60 seconds.</p>
	<p>Lock</p>	<p>Controls user access to adjustments. When Lock is selected, no user adjustments are allowed. All buttons are locked.</p> <p> NOTE:</p> <ul style="list-style-type: none"> • Lock – Either soft lock (through the OSD menu) or hard lock (press and hold the button beside the power button for 6 seconds) • Unlock – Only hard unlock (press and hold the button beside the power button for 6 seconds)
	<p>Reset Menu</p>	<p>Reset all OSD settings to the factory preset values.</p>

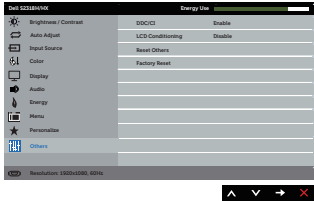
	<p>Personalize</p>	<p>Users can choose a feature from Shortcut Key 1, Shortcut Key 2, Reset Personalization, Preset Modes or Brightness/Contrast and set it as a shortcut key.</p> 
	<p>Shortcut Key 1</p>	<p>User can select one of the followings: Preset Modes, Brightness/Contrast, Auto Adjust, Input Source, Aspect Ratio and Volume to set the Shortcut Key 1.</p>
	<p>Shortcut Key 2</p>	<p>User can select one of the followings: Preset Modes, Brightness/Contrast, Auto Adjust, Input Source, Aspect Ratio and Volume to set the Shortcut Key 2.</p>
	<p>Reset Personalization</p>	<p>Allows you to restore shortcut key to the default setting.</p>
	<p>Others</p>	

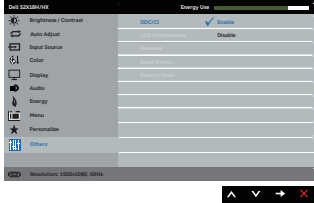
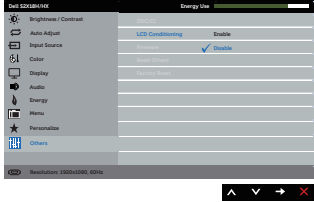
<p>DDC/CI</p>	<p>DDC/CI (Display Data Channel/Command Interface) allows your monitor parameters (brightness, color balance and etc.) to be adjustable via the software on your computer.</p> <p>You can disable this feature by selecting Disable.</p> <p>Enable this feature for best user experience and optimum performance of your monitor.</p> 
<p>LCD Conditioning</p>	<p>Helps reduce minor cases of image retention. Depending on the degree of image retention, the program may take some time to run. To start LCD conditioning, select Enable.</p> 
<p>Reset Other</p>	<p>Reset all settings under the Others setting menu to the factory preset values.</p>
<p>Factory Reset</p>	<p>Reset all settings to the factory preset values.</p>

 **NOTE:** Your monitor has a built-in feature to automatically calibrate the brightness to compensate for LED aging.

OSD Warning Messages

When the **Dynamic Contrast** feature is enabled (in these preset modes: **Game** or **Movie**), the manual brightness adjustment is disabled.

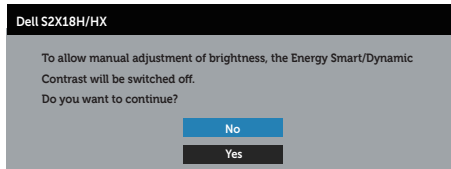

When the monitor does not support a particular resolution mode, the following message is displayed:

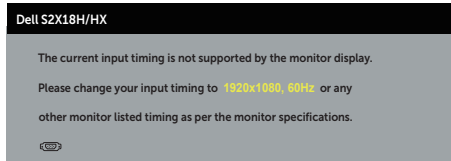

This means that the monitor cannot synchronize with the signal that it is receiving from the computer. See [Monitor Specifications](#) for the Horizontal and Vertical frequency ranges addressable by this monitor. Recommended mode is 1920 x 1080.

You will see the following message before the **DDC/CI** function is disabled:

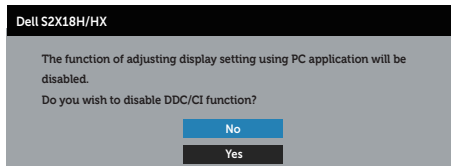

When the monitor enters the **Power Save Mode**, the following message appears:



If you press any button other than the power button, the following messages will appear depending on the selected input:

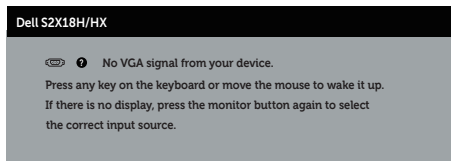

If VGA or HDMI cable is not connected, a floating dialog box as shown below appears. The monitor will enter Power Save Mode after 4 minutes if left at this state.

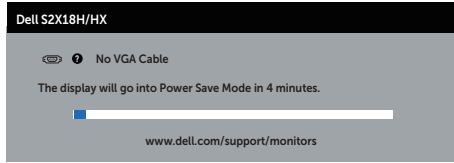

Or

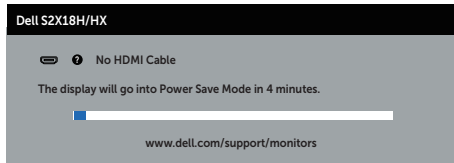

See [Troubleshooting](#) for more information.

Setting the Maximum Resolution

To set the maximum resolution for the monitor:

In Windows 7, Windows 8, Windows 8.1 and Windows 10:

1. For Windows 8 and Windows 8.1, select the Desktop tile to switch to classic desktop.
2. Right-click on the desktop and click **Screen Resolution**.
3. Click the Dropdown list of the Screen Resolution and select **1920 x 1080**.
4. Click **OK**.

If you do not see 1920 x 1080 as an option, you may need to update your graphics driver. Depending on your computer, complete one of the following procedures:

If you have a Dell desktop or portable computer:

- Go to **www.dell.com/support**, enter your service tag, and download the latest driver for your graphics card.

If you are using a non-Dell computer (portable or desktop):

- Go to the support site for your computer and download the latest graphic drivers.
- Go to your graphics card website and download the latest graphic drivers.

Using the Tilt

 **NOTE:** This is applicable for a monitor with a stand. When any other stand is bought, please refer to the respective stand setup guide for set up instructions.

Rotating the Monitor

Before you rotate the monitor, your monitor should be fully vertically extended and fully tilted up to avoid hitting the bottom edge of the monitor.

 **NOTE:** The stand is detached when the monitor is shipped from the factory.

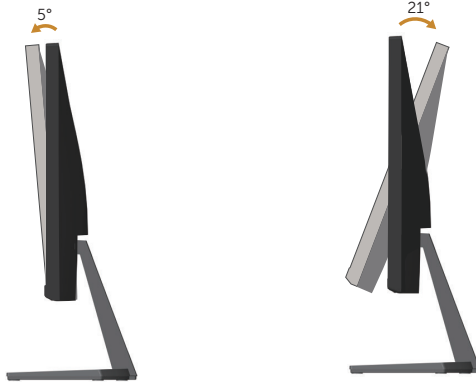

Troubleshooting

⚠ WARNING: Before you begin any of the procedures in this section, follow the [Safety Instructions](#).

Self-Test

Your monitor provides a self-test feature that allows you to check if your monitor is functioning properly. If your monitor and computer are properly connected but the monitor screen remains dark, run the monitor self-test by performing the following steps:

1. Turn off both your computer and the monitor.
2. Disconnect the video cable from the back of the computer. To ensure proper Self-Test operation, remove all digital and analog cables from the back of monitor.
3. Turn on the monitor.

If the monitor is working correctly, it detects that there is no signal and one of the following messages appears. While in self-test mode, the power LED remains white.

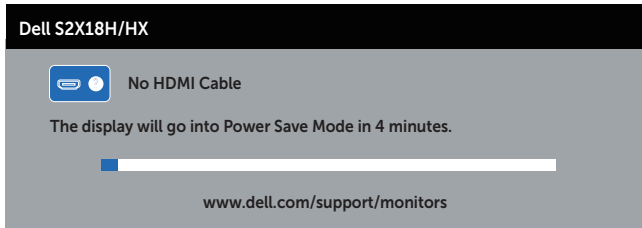

📌 NOTE: This box also appears during normal system operation, if the video cable is disconnected or damaged.

4. Turn off your monitor and reconnect the video cable; then turn on both your computer and the monitor.

If your monitor remains dark after you reconnect the cables, check your video controller and computer, because your monitor is functioning properly.

Built-in diagnostics

Your monitor has a built-in diagnostic tool that helps you determine if any screen abnormality you experience is an inherent problem with your monitor, or with your computer and video card.

📌 NOTE: You can run the built-in diagnostics only when the video cable is

unplugged and the monitor is in *self-test mode*.

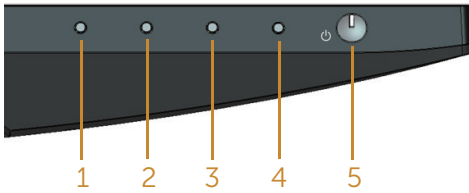

To run the built-in diagnostics:

1. Ensure that the screen is clean (no dust particles on the surface of the screen).
2. Unplug the video cable(s) from the back of the computer or monitor. The monitor then goes into the self-test mode.
3. Press and hold Button 1 for 5 seconds. A gray screen appears.
4. Carefully inspect the screen for abnormalities.
5. Press Button 1 on the bottom of the monitor again. The color of the screen changes to red.
6. Inspect the display for any abnormalities.
7. Repeat steps 5 and 6 to inspect the display in green, blue, black, white and text screens.

The test is complete when the text screen appears. To exit, press Button 1 again. If you do not detect any screen abnormalities upon using the built-in diagnostic tool, the monitor is functioning properly. Check the video card and computer.

Common Problems

The following table contains general information about common monitor problems you might encounter and the possible solutions:

Common Symptoms	What You Experience	Possible Solutions
No Video/Power LED off	No picture	<ul style="list-style-type: none"> • Ensure that the video cable connecting the monitor and the computer is properly connected and secure. • Verify that the power outlet is functioning properly using any other electrical equipment. • Ensure that the correct input source is selected via the Input Source menu.
No Video/Power LED on	No picture or no brightness	<ul style="list-style-type: none"> • Increase brightness and contrast controls using the OSD. • Perform monitor self-test feature check. • Check for bent or broken pins in the video cable connector. • Run the built-in diagnostics. • Ensure that the correct input source is selected via the Input Source menu.
Poor Focus	Picture is fuzzy, blurry, or ghosting	<ul style="list-style-type: none"> • Eliminate video extension cables. • Reset the monitor to Factory Settings(Factory Reset). • Change the video resolution to the correct aspect ratio.
Shaky/Jittery Video	Wavy picture or fine movement	<ul style="list-style-type: none"> • Reset the monitor to Factory Settings(Factory Reset). • Check environmental factors. • Relocate the monitor and test in another room.
Missing Pixels	LCD screen has spots	<ul style="list-style-type: none"> • Cycle power On-Off. • Pixel that is permanently Off is a natural defect that can occur in LCD technology. • For more information on Dell Monitor Quality and Pixel Policy, see Dell Support site at: www.dell.com/support/monitors.
Stuck-on Pixels	LCD screen has bright spots	<ul style="list-style-type: none"> • Cycle power On-Off. • Pixel that is permanently off is a natural defect that can occur in LCD technology. • For more information on Dell Monitor Quality and Pixel Policy, see Dell Support site at: http://www.dell.com/support/monitors.
Brightness Problems	Picture too dim or too bright	<ul style="list-style-type: none"> • Reset the monitor to Factory Settings(Factory Reset). • Adjust brightness & contrast controls via OSD.
Geometric Distortion	Screen not centered correctly	<ul style="list-style-type: none"> • Reset the monitor to Factory Settings(Factory Reset). • Adjust horizontal & vertical controls via OSD.

No sound or sound is low	Monitor has no sound or sound is low	<ul style="list-style-type: none"> • Make sure the audio cable is properly connected to the monitor. • Adjust the volume settings of both your monitor and computer. • Make sure the computer sound card driver is properly installed and activated. • Make sure the audio source is correct on the OSD.
Horizontal/Vertical Lines	Screen has one or more lines	<ul style="list-style-type: none"> • Reset the monitor to Factory Settings(Factory Reset). • Perform monitor self-test feature check and determine if these lines are also in self-test mode. • Check for bent or broken pins in the video cable connector. • Run the built-in diagnostics.
Synchronization Problems	Screen is scrambled or appears torn	<ul style="list-style-type: none"> • Reset the monitor to Factory Settings(Factory Reset). • Perform monitor self-test feature check to determine if the scrambled screen appears in self-test mode. • Check for bent or broken pins in the video cable connector. • Restart the computer in the <i>safe mode</i>.
Safety Related Issues	Visible signs of smoke or sparks	<ul style="list-style-type: none"> • Do not perform any troubleshooting steps. • Contact Dell immediately.
Intermittent Problems	Monitor malfunctions on & off	<ul style="list-style-type: none"> • Ensure that the video cable connecting the monitor to the computer is connected properly and is secure. • Reset the monitor to Factory Settings(Factory Reset). • Perform monitor self-test feature check to determine if the intermittent problem occurs in self-test mode.
Missing Color	Picture missing color	<ul style="list-style-type: none"> • Perform monitor self-test feature check. • Ensure that the video cable connecting the monitor to the computer is connected properly and is secure. • Check for bent or broken pins in the video cable connector.
Wrong Color	Picture color not good	<ul style="list-style-type: none"> • Change the Color Setting Mode in the Color Settings OSD to Graphics or Video depending on the application. • Try different Preset Modes in Color settings OSD. Adjust R/G/B value in Custom Color in Color settings OSD. • Change the Input Color Format to RGB or YPbPr in the Color settings OSD. • Run the built-in diagnostics.
Image retention from a static image left on the monitor for a long period of time	Faint shadow from the static image displayed appears on the screen	<ul style="list-style-type: none"> • Use the Power Management feature to turn off the monitor at all times when not in use (for more information, see Power Management Modes). • Alternatively, use a dynamically changing screensaver.

Video Ghosting
or Overshooting

Moving image
appears to have
trailing shadow
or bright edge.



- Change the **Response Time** in the **Display** OSD to **Fast** or **Normal** depending on your application and usage.
-

Product-Specific Problems

Specific Symptoms	What You Experience	Possible Solutions
Screen image is too small	Image is centered on screen, but does not fill entire viewing area	<ul style="list-style-type: none">• Check the Aspect Ratio setting in the Display settings OSD.• Reset the monitor to Factory Settings (Factory Reset) .
Cannot adjust the monitor with the buttons on the side panel	OSD does not appear on the screen	<ul style="list-style-type: none">• Turn Off the monitor, unplug the power cord, plug it back, and then turn On the monitor.• Check if the OSD menu is locked. If yes, press and hold the button above the Power button for 6 seconds to unlock. (For more information, see Lock).
No Input Signal when user controls are pressed	No picture, the LED light is white	<ul style="list-style-type: none">• Check the signal source. Ensure the computer is not in standby or sleep mode by moving the mouse or pressing any key on the keyboard.• Check if the video cable is plugged in properly. Disconnect and reconnect the video cable if necessary.• Reset the computer or video player.
The picture does not fill the entire screen	The picture cannot fill the height or width of the screen	<ul style="list-style-type: none">• Due to different video formats (aspect ratio) of DVDs, the monitor may display in full screen.• Run the built-in diagnostics.

Appendix

WARNING: Safety Instructions

-  **WARNING:** Use of controls, adjustments, or procedures other than those specified in this documentation may result in exposure to shock, electrical hazards, and/or mechanical hazards.
-  **WARNING:** For displays with glossy bezels the user should consider the placement of the display as the bezel may cause disturbing reflections from surrounding light and bright surfaces.

For information on safety instructions, see the *Product Information Guide*.

FCC Notices (U.S. Only) and Other Regulatory Information

For FCC notices and other regulatory information, see the regulatory compliance website located at www.dell.com/regulatory_compliance.

Contact Dell

For customers in the United States, call 800-WWW-DELL (800-999-3355).

-  **NOTE:** If you do not have an active Internet connection, you can find contact information on your purchase invoice, packing slip, bill, or Dell product catalog.

Dell provides several online and telephone-based support and service options. Availability varies by country and product, and some services may not be available in your area.

To get online Monitor support content:

1. Visit www.dell.com/support/monitors.

To contact Dell for sales, technical support, or customer service issues:

1. Visit www.dell.com/support.
2. Verify your country or region in the **Choose A Country/Region** drop-down menu at the bottom of the page.
3. Click **Contact Us** on the left side of the page.
4. Select the appropriate service or support link based on your need.
5. Choose the method of contacting Dell that is convenient for you.

-  **WARNING:** For displays with glossy bezels the user should consider the placement of the display as the bezel may cause disturbing reflections from surrounding light and bright surfaces.

Setting Up Your Monitor

Setting the display resolution

For maximum display performance with Microsoft Windows operating systems, set the display resolution to **1920 x 1080** pixels by performing the following steps:

In Windows 7, Windows 8, Windows 8.1 and Windows 10:

1. For Windows 8 and Windows 8.1, select the Desktop tile to switch to classic desktop.
2. Right-click on the desktop and click **Screen Resolution**.
3. Click the Dropdown list of the Screen Resolution and select **1920 x 1080**.
4. Click **OK**.

If you do not see the recommended resolution as an option, you may need to update your graphics driver. Please choose the scenario below that best describes the computer system you are using, and follow the given steps.

If you have a Dell™ desktop or a Dell™ portable computer with internet access

1. Go to www.dell.com/support, enter your init-caps, and download the latest driver for your graphics card.
2. After installing the drivers for your graphics adapter, attempt to set the resolution to **1920 x 1080** again.



NOTE: If you are unable to set the resolution to **1920 x 1080**, please contact Dell™ to inquire about a graphics adapter that supports these resolutions.

If you have a non Dell™ desktop, portable computer, or graphics card

In Windows 7, Windows 8, Windows 8.1 and Windows 10:

1. For Windows 8 and Windows 8.1, select the Desktop tile to switch to classic desktop.
2. Right-click on the desktop and click **Personalization**.
3. Click **Change Display Settings**.
4. Click **Advanced Settings**.
5. Identify your graphics controller supplier from the description at the top of the window (e.g. NVIDIA, ATI, Intel etc.).
6. Refer to the graphic card provider website for updated driver (for example, www.ATI.com OR www.NVIDIA.com).

7. After installing the drivers for your graphics adapter, attempt to set the resolution to **1920 x 1080** again.



NOTE: If you are unable to set the recommended resolution, contact the manufacturer of your computer or consider purchasing a graphics adapter that will support the video resolution.

Monitor Specifications

Flat Panel Specifications

Model	S2218H	S2318H/S2318HX
Screen type	Active matrix - TFT LCD	Active matrix - TFT LCD
Panel type	In-plane Switching	In-plane Switching
Viewable image		
Diagonal	54.61 cm (21.5 in)	58.42 cm (23 in)
Horizontal, Active Area	476.06 mm (18.74 in)	509.18 mm (20.05 in)
Vertical, Active Area	267.78 mm (10.54 in)	286.41 mm (11.28 in)
Area	1274.79 cm ² (197.59 inch ²)	1458.34 cm ² (226.04 inch ²)
Pixel pitch	0.248 mm	0.265mm
Viewing angle (vertical / horizontal)	178° / 178° (typical)	178° / 178° (typical)
Luminance output	250 cd/m ² (typical),	250 cd/m ² (typical)
Contrast ratio	1000 to 1 (typical) 8,000,000 to 1 (Dynamic Contrast)	1000 to 1 (typical) 8,000,000 to 1 (Dynamic Contrast)
Faceplate coating	Low Haze with 3H hardness	Low Haze with 3H hardness
Backlight	LED edgelight system	LED edgelight system
Response time	6ms gray to gray (typical)	6ms gray to gray (typical)
Color depth	16.78 million colors	16.78 million colors
Color gamut	82%(typical)*	82%(typical)*

*[S2218H/S2318H/S2318HX] color gamut(typical) is based on CIE1976(82%) and CIE1931(72%) test standards.

Resolution Specifications

Model	S2218H/S2318H/S2318HX
Horizontal scan range	30 kHz to 83 kHz (automatic)
Vertical scan range	56 Hz to 76 Hz (automatic)
Maximum preset resolution	1920 x 1080 at 60 Hz

Preset Display Modes

Display Mode	Horizontal Frequency (kHz)	Vertical Frequency (Hz)	Pixel Clock (MHz)	Sync Polarity (Horizontal / Vertical)
VESA, 720 x 400	31.5	70.1	28.3	-/+
VESA, 640 x 480	31.5	60.0	25.2	-/-
VESA, 640 x 480	37.5	75.0	31.5	-/-
VESA, 800 x 600	37.9	60.3	40.0	+/+
VESA, 800 x 600	46.9	75.0	49.5	+/+
VESA, 1024 x 768	48.4	60.0	65.0	-/-
VESA, 1024 x 768	60.0	75.0	78.8	+/+
VESA, 1152 x 864	67.5	75.0	108.0	+/+
VESA, 1280 x 1024	64.0	60.0	108.0	+/+
VESA, 1280 x 1024	80.0	75.0	135.0	+/+
VESA, 1600 x 900	60.0	60.0	108.0	+/+
VESA, 1920 x 1080	67.5	60.0	148.5	+/+

Electrical Specifications

Model		S2218H & S2318H&S2318HX
Video input signals		<ul style="list-style-type: none"> Analog RGB, 0.7 Volts +/-5%, positive polarity at 75 ohm input impedance HDMI1.4, 600 mV for each differential line, positive polarity at 100 ohm input impedance
Synchronization input signals		Separate horizontal and vertical synchronizations, polarity-free TTL level, SOG (Composite SYNC on green)
Inrush current		No damage at cold starting
AC/DC Adapter*	Input voltage/ frequency/ current	Delta adapter ADP-40DD B: 100 VAC to 240 VAC/50 Hz to 60 Hz \pm 3 Hz/1.5 A (Max.), Lite-On adapter PA-1041-81: 100 VAC to 240 VAC/50 Hz to 60 Hz \pm 3 Hz/1.2 A (Max).
	Output voltage/ current	Output: 12VDC/3.33A

Physical Characteristics

Model	S2218H	S2318H	S2318HX
Signal cable type	<ul style="list-style-type: none"> Digital: detachable, HDMI, 19 pins. Analog: detachable, D-Sub, 15 pins 	<ul style="list-style-type: none"> Digital: detachable, HDMI, 19 pins. Analog: detachable, D-Sub, 15 pins 	<ul style="list-style-type: none"> Digital: detachable, HDMI, 19 pins. Analog: detachable, D-Sub, 15 pins
Dimensions (with stand)			
Height	385.5 mm (15.18 in)	404.0 mm (15.90 in)	404.0 mm (15.90 in)
Width	489.5 mm (19.27 in)	522.2 mm (20.56 in)	522.2 mm (20.56 in)
Depth	147.9 mm (5.82 in)	147.9 mm (5.82 in)	147.9 mm (5.82 in)
Dimensions (without stand)			
Height	293.9 mm (11.57 in)	312.3 mm (12.29 in)	312.3 mm (12.29 in)
Width	489.5 mm (19.27 in)	522.2 mm (20.56 in)	522.2 mm (20.56 in)
Depth	49.1 mm (1.93 in)	49.1 mm (1.93 in)	49.1 mm (1.93 in)
Stand dimensions			
Height	171.6 mm (6.76 in)	171.6 mm (6.76 in)	171.6 mm (6.76 in)
Width	246.6 mm (9.71 in)	246.6 mm (9.71 in)	246.6 mm (9.71 in)
Depth	147.9 mm (5.82 in)	147.9 mm (5.82 in)	147.9 mm (5.82 in)
Weight			
Weight with packaging	5 kg (11.02 lb)	5.46 kg (12.04 lb)	5.55 kg (12.24 lb)
Weight with stand assembly and cables	3.34 kg (7.36 lb)	3.69 kg (8.13 lb)	3.78 kg (8.34 lb)
Weight without stand assembly	2.33 kg (5.14 lb)	2.69 kg (5.92 lb)	2.69 kg (5.92 lb)
Weight of stand assembly	0.53 kg (1.17 lb)	0.53 kg (1.17 lb)	0.53 kg (1.17 lb)
Front frame gloss (minimum)	Black frame – 85 gloss unit	Black frame - 85 gloss unit	Black frame - 85 gloss unit

Environmental Characteristics

Model		S2218H	S2318H/S2318HX
Temperature			
Operating		0°C to 40°C (32°F to 104°F)	
Non-operating	Storage	<ul style="list-style-type: none"> -20°C to 60°C (-4°F to 140°F) 	
	Shipping	<ul style="list-style-type: none"> -20°C to 60°C (-4°F to 140°F) 	
Humidity			
Operating		10% to 80% (non-condensing)	
Non-operating		<ul style="list-style-type: none"> Storage: 5% to 90% (non-condensing) Shipping: 5% to 90% (non-condensing) 	
Altitude			
Operating (maximum)		5,000 m (16,400 ft)	
Non-operating (maximum)		12,192 m (40,000 ft)	
Thermal dissipation		<ul style="list-style-type: none"> 102.36 BTU/hour (maximum) 75.07 BTU/hour (typical) 	<ul style="list-style-type: none"> 116.01 BTU/hour (maximum) 78.48 BTU/hour (typical)

Power Management Modes

If you have VESA's DPM™ compliance display card or software installed in your PC, the monitor can automatically reduce its power consumption when not in use. This is referred to as Power Save Mode*. If the computer detects input from the keyboard, mouse or other input devices, the monitor automatically resumes functioning. The following table shows the power consumption and signaling of this automatic power saving feature.

*Zero power consumption in off mode can only be achieved by disconnecting the main cable from the monitor.

S2218H

VESA Modes	Horizontal Sync	Vertical Sync	Video	Power Indicator	Power Consumption
Normal operation	Active	Active	Active	White	30 W (maximum)** 22 W (typical)
Active-off mode	Inactive	Inactive	Blanked	White (Glowing)	Less than 0.3 W
Switch off	-	-	-	Off	Less than 0.3 W

Energy Star	Power Consumption
P _{ON}	16 W
E _{TEC}	50.59 Kwh

S2318H/S2318HX

VESA Modes	Horizontal Sync	Vertical Sync	Video	Power Indicator	Power Consumption
Normal operation	Active	Active	Active	White	34 W (maximum) 23 W (typical)
Active-off mode	Inactive	Inactive	Blanked	White (Glowing)	Less than 0.3 W
Switch off	-	-	-	Off	Less than 0.3 W

Energy Star	Power Consumption
P _{ON}	16 W
E _{TEC}	50.81 Kwh

P_{ON}: Power consumption of on mode as defined in Energy Star 7.0 version.

E_{TEC}: Total energy consumption in KWh as defined in Energy Star 7.0 version.

This document is informational only and reflects laboratory performance. Your product may perform differently, depending on the software, components and peripherals you ordered and shall have no obligation to update such information. Accordingly, the customer should not rely upon this information in making decisions about electrical tolerances or otherwise. No warranty as to accuracy or completeness is expressed or implied.

 **NOTE:** This monitor is ENERGY STAR-compliant.



Speaker Specifications

Model	S2218H/S2318H/S2318HX
Speaker rated power	2 x 3 W
Frequency Response	200 Hz - 20 kHz
Impedance	8 ohm

The OSD functions only in the normal operation mode. When any button is pressed in the Active-off mode, the following message will be displayed:

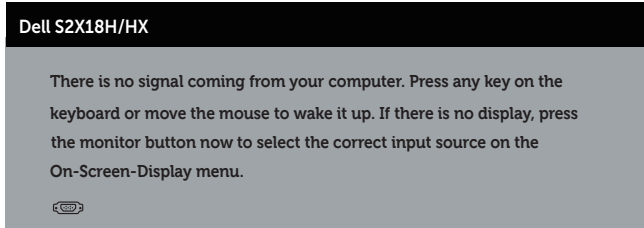

Activate the computer and the monitor to gain access to the OSD.

Pin Assignments

VGA Connector

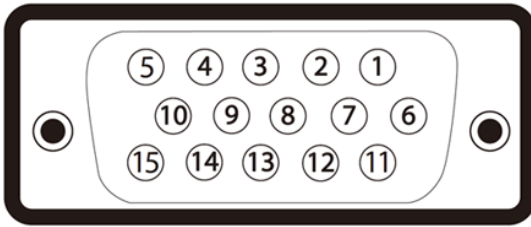

Pin Number	15-pin Side of the Connected Signal Cable
1	Video-Red
2	Video-Green
3	Video-Blue
4	GND
5	Self-test
6	GND-R
7	GND-G
8	GND-B
9	Computer 5V/3.3V
10	GND-sync
11	GND
12	DDC data
13	H-sync
14	V-sync
15	DDC clock

HDMI Connector

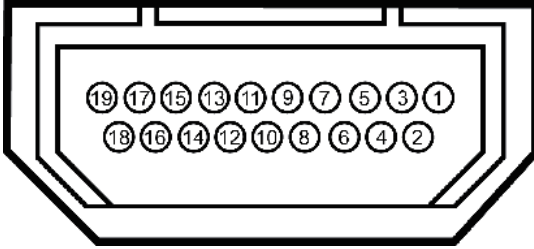

Pin Number	19-pin Side of the Connected Signal Cable
1	T.M.D.S. Data 2-
2	T.M.D.S. Data 2 Shield
3	T.M.D.S. Data 2+
4	T.M.D.S. Data 1+
5	T.M.D.S. Data 1 Shield
6	T.M.D.S. Data 1 -
7	T.M.D.S. Data 0+
8	T.M.D.S. Data 0 Shield
9	T.M.D.S. Data 0-
10	T.M.D.S. Clock +
11	T.M.D.S. Clock Shield
12	T.M.D.S. Clock -
13	CEC
14	Reserved (N.C. on device)
15	SCL
16	SDA
17	DDC/CEC Ground
18	+5V Power
19	Hot Plug Detect