

# INSPIRON™

## SETUP GUIDE





# INSPIRON™

## SETUP GUIDE

Regulatory model: D06D

Regulatory type: D06D001

# Notes, Cautions, and Warnings



**NOTE:** A NOTE indicates important information that helps you make better use of your computer.



**CAUTION:** A CAUTION indicates either potential damage to hardware or loss of data and tells you how to avoid the problem.



**WARNING:** A WARNING indicates a potential for property damage, personal injury, or death.

---

Information in this document is subject to change without notice.

© 2011 Dell Inc. All rights reserved.

Reproduction of these materials in any manner whatsoever without the written permission of Dell Inc. is strictly forbidden.

Trademarks used in this text: Dell™, the DELL logo, Inspiron™, Solution Station™, and DellConnect™ are trademarks of Dell Inc.; Intel®, Celeron®, and Pentium® are registered trademarks and Core™ is a trademark of Intel Corporation in the U.S. and other countries; Microsoft®, Windows®, and the Windows start button logo are either trademarks or registered trademarks of Microsoft Corporation in the United States and/or other countries; Blu-ray Disc™ is a trademark of the Blu-ray Disc Association; Bluetooth® is a registered trademark owned by Bluetooth SIG, Inc. and is used by Dell under license.

Other trademarks and trade names may be used in this document to refer to either the entities claiming the marks and names or their products. Dell Inc. disclaims any proprietary interest in trademarks and trade names other than its own.

# Contents

## Setting Up Your Inspiron Desktop . . . 5

Before Setting Up Your Computer . . . . .	5
Connect the Display . . . . .	6
Connect the Keyboard and Mouse . . . . .	8
Connect the Network Cable (Optional) . . . . .	9
Connect the Power Cable . . . . .	10
Press the Power Button . . . . .	10
Set Up the Operating System . . . . .	11
Create System Recovery Media (Recommended) . . . . .	12
Set Up the TV Tuner (Optional) . . . . .	13
Connect to the Internet (Optional) . . . . .	13

## Using Your Inspiron Desktop . . . . . 16

Front View Features . . . . .	16
Back View Features . . . . .	20
Back Panel Connectors . . . . .	22

Software Features . . . . .	24
Dell DataSafe Online Backup . . . . .	25
Dell Stage . . . . .	25

## Solving Problems . . . . . 27

Beep Codes . . . . .	27
Network Problems . . . . .	28
Power Problems . . . . .	29
Memory Problems . . . . .	30
Lockups and Software Problems . . . . .	31

## Using Support Tools . . . . . 34

Dell Support Center . . . . .	34
My Dell Downloads . . . . .	35
System Messages . . . . .	36
Hardware Troubleshooter . . . . .	38
Dell Diagnostics . . . . .	38

## Contents

<b>Restoring Your Operating System</b> .....	<b>41</b>	<b>Finding More Information and Resources</b> .....	<b>58</b>
System Restore .....	42	<b>Specifications</b> .....	<b>60</b>
Dell DataSafe Local Backup .....	43	<b>Appendix</b> .....	<b>65</b>
System Recovery Media .....	46	Information for NOM, or Official Mexican Standard (Only for Mexico) . . .	65
Dell Factory Image Restore .....	47	<b>Index</b> .....	<b>66</b>
<b>Getting Help</b> .....	<b>49</b>		
Technical Support and Customer Service .....	50		
DellConnect .....	50		
Online Services .....	51		
Automated Order-Status Service .....	52		
Product Information .....	52		
Returning Items for Repair Under Warranty or for Credit .....	53		
Before You Call .....	55		
Contacting Dell .....	57		

# Setting Up Your Inspiron Desktop

This section provides information about setting up your Dell Inspiron 620s desktop.



**WARNING:** Before you begin any of the procedures in this section, read the safety information that shipped with your computer. For additional safety best practices information, see the Regulatory Compliance Homepage at [www.dell.com/regulatory\\_compliance](http://www.dell.com/regulatory_compliance).

## Before Setting Up Your Computer

When positioning your computer, ensure that you allow easy access to a power source, adequate ventilation, and a level surface to place your computer.

Restricting airflow around your computer may cause it to overheat. To prevent overheating ensure that you leave at least 10.2 cm (4 inches) at the back of the computer and a minimum of 5.1 cm (2 inches) on all other sides. You should never place your computer in an enclosed space, such as a cabinet or a drawer when it is powered on.

# Connect the Display

If you purchased the optional discrete graphics card, connect the display using the connector on the discrete graphics card. Otherwise, connect the display using either the integrated VGA or HDMI connector.

 **NOTE:** The integrated VGA and HDMI connectors are disabled if your computer has a discrete graphics card.

Use the appropriate cable based on the connectors available on your computer and display. You may need to use an appropriate adapter (DVI-to-VGA adapter or HDMI-to-DVI adapter) to connect your display to the discrete graphics card if the connector on your display and the discrete graphics card is different.











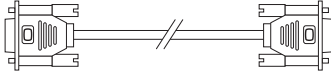

You can purchase the DVI-to-VGA adapter, HDMI-to-DVI adapter, and additional HDMI or DVI cables at [www.dell.com](http://www.dell.com).

 **NOTE:** When connecting to a single display, connect the display to ONLY ONE of the connectors on your computer.

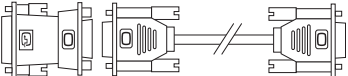
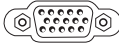
 **NOTE:** Your computer supports the Intel multiple monitor feature (disabled by default). This feature allows you to connect your computer to more than one monitor simultaneously. To enable this feature, enter the system setup (BIOS) utility and set the `Intel Multiple Monitor Feature` to `Auto` in the `Advanced Graphic Configuration` section.

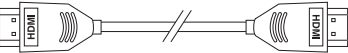

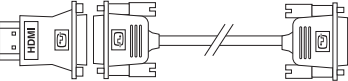
See the following table to identify the connectors on your computer and display.

Connection Type	Computer	Cable	Display
VGA-to-VGA (VGA cable)			
DVI-to-DVI (DVI cable)			
DVI-to-VGA (DVI-to-VGA adapter + VGA cable)			
HDMI-to-HDMI (HDMI cable)			
HDMI-to-DVI (HDMI-to-DVI adapter + DVI cable)			

## Connect the Keyboard and Mouse

Connect the USB keyboard and mouse to the USB connectors on the back panel of your computer.

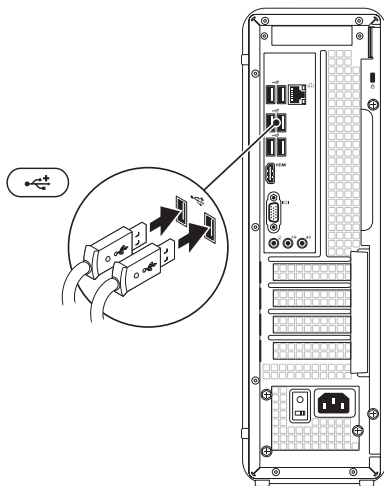

## Connect the Network Cable (Optional)

A network connection is not required to complete your computer setup, but if you have an existing network or Internet connection that uses a cable connection (such as a broadband device or Ethernet jack), you can connect it now.

 **NOTE:** Use only an Ethernet cable (RJ45 connector) to connect to the network connector. Do not plug a telephone cable (RJ11 connector) into the network connector.

To connect your computer to a network or a broadband device, connect one end of the network cable to either a network port or a broadband device. Connect the other end of the network cable to the network connector (RJ45 connector) on the back panel of your computer. A click indicates that the network cable has been securely attached.

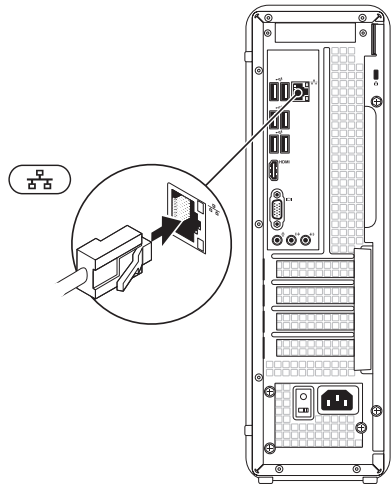

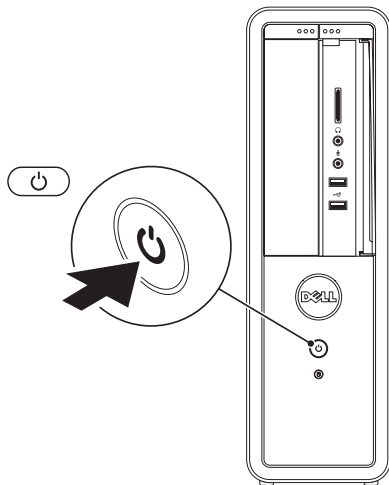
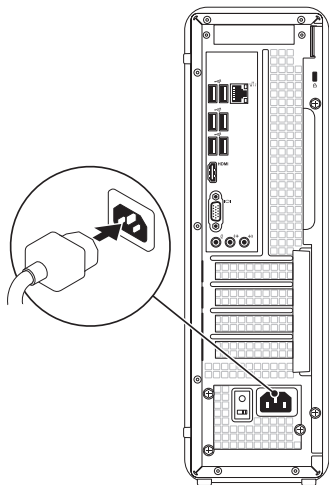

## Connect the Power Cable Press the Power Button



## Set Up the Operating System

Your Dell computer is preconfigured with the Microsoft Windows operating system. To set up Windows for the first time, follow the instructions on the screen. These steps are mandatory and may take some time to complete. The Windows setup screens will take you through several procedures including accepting license agreements, setting preferences, and setting up an Internet connection.

 **CAUTION: Do not interrupt the operating system's setup process. Doing so may render your computer unusable and you will need to reinstall the operating system.**

 **NOTE:** For optimal performance of your computer, it is recommended that you download and install the latest BIOS and drivers for your computer available at **[support.dell.com](http://support.dell.com)**.

 **NOTE:** For more information on the operating system and features, go to **[support.dell.com/MyNewDell](http://support.dell.com/MyNewDell)**.

# Create System Recovery Media (Recommended)

 **NOTE:** It is recommended that you create a system recovery media as soon as you set up Microsoft Windows.

The system recovery media can be used to restore your computer to the operating state it was in when you purchased the computer, while preserving data files (without the need of the *Operating System* disc). You can use the system recovery media if changes to the hardware, software, drivers, or other system settings have left the computer in an undesirable operating state.

You will require the following to create the system recovery media:

- Dell DataSafe Local Backup
- USB key with a minimum capacity of 8 GB or DVD-R/DVD+R/Blu-ray Disc

 **NOTE:** Dell DataSafe Local Backup does not support rewritable discs.

To create a system recovery media:

1. Insert the disc or USB key in the computer.
2. Click **Start**  → **All Programs** → **Dell DataSafe Local Backup**.
3. Click **Create Recovery Media**.
4. Follow the instructions on the screen.

 **NOTE:** For information on restoring your operating system using the system recovery media, see “System Recovery Media” on page 46.

## Set Up the TV Tuner (Optional)

 **NOTE:** Availability of the TV tuner may vary by region.

To set up the TV tuner:

1. Connect the TV/digital antenna cable or the cable adapter to the antenna-in connector on your computer.
2. Turn on your computer.
3. Click **Start**  → **All Programs** → **Windows Media Center** → **Tasks** → **Settings** → **TV**.
4. Follow the instructions on the screen.

## Connect to the Internet (Optional)

To connect to the Internet, you need an external modem or network connection and an Internet Service Provider (ISP).

If an external USB modem or WLAN adapter is not a part of your original order, you can purchase one from [www.dell.com](http://www.dell.com).

### Setting Up a Wired Connection

- If you are using a dial-up connection, connect the telephone line to the optional external USB modem and to the telephone wall connector before you set up your Internet connection.
- If you are using a DSL or cable/satellite modem connection, contact your ISP or cellular telephone service for setup instructions.

To complete setting up your wired Internet connection, follow the instructions in “Setting Up Your Internet Connection” on page 14.

### Setting Up a Wireless Connection

 **NOTE:** To set up your wireless router, see the documentation that shipped with your router.

Before you can use your wireless Internet connection, you need to connect to your wireless router.

To set up your connection to a wireless router:

1. Save and close any open files, and exit any open programs.
2. Click **Start**  → **Control Panel**.
3. In the search box, type `network`, and then click **Network and Sharing Center** → **Connect to a network**.
4. Follow the instructions on the screen to complete the setup.

### Setting Up Your Internet Connection

ISPs and ISP offerings vary by country. Contact your ISP for offerings available in your country.

If you cannot connect to the Internet but have successfully connected in the past, the ISP might have a service outage. Contact your ISP to check the service status, or try connecting again later.

Have your ISP information ready. If you do not have an ISP, the **Connect to the Internet** wizard can help you get one.



To set up your Internet connection:

1. Save and close any open files, and exit any open programs.
2. Click **Start**  → **Control Panel**.
3. In the search box, type *network*, and then click **Network and Sharing Center** → **Set up a new connection or network** → **Connect to the Internet**.

The **Connect to the Internet** window appears.

-  **NOTE:** If you do not know which type of connection to select, click **Help me choose** or contact your ISP.
4. Follow the instructions on the screen and use the setup information provided by your ISP to complete the setup.

# Using Your Inspiron Desktop

This section provides information about the features available on your inspiron desktop.

## Front View Features

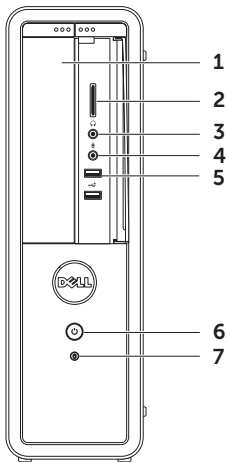

- 1 Optical drive** — Plays or records CDs, DVDs, and Blu-ray Discs (optional).
- 2 Media Card Reader** — Provides a fast and convenient way to view and share digital photos, music, and videos stored on a media card.

-  **Headphone connector** — Connects to a pair of headphones.

**NOTE:** To connect to a powered speaker or sound system, use the line-out connector at the back of your computer.

-  **Microphone or line-in connector** — Connects to a microphone or inputs signal for use with audio programs.

-  **USB 2.0 connectors (2)** — Connect to USB devices, such as a mouse, keyboard, printer, external drive, or MP3 player.

- 6  **Power button and light** — Turns the computer on or off when pressed. The light in the center of this button indicates the power state:
- Off — The computer is either turned off, in hibernate mode, or is not receiving power.
  - Solid white — The computer is on.
  - Solid amber — The computer is in sleep/standby mode or there might be a problem with the system board or the power supply. Contact Dell (see “Contacting Dell” on page 57) for assistance.
  - Blinking amber — There may be a problem with either the system board or the power supply. Contact Dell (see “Contacting Dell” on page 57) for assistance.

**NOTE:** For information on power problems, see “Power Problems” on page 29.

- 7  **Hard drive activity light** — Turns on when the computer reads or writes data. A blinking white light indicates hard drive activity.

 **CAUTION: To avoid loss of data, never turn off the computer while the hard drive activity light is blinking.**



## Back View Features

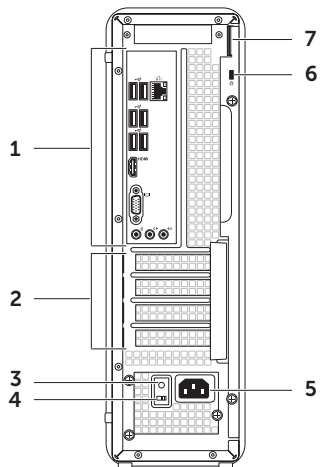





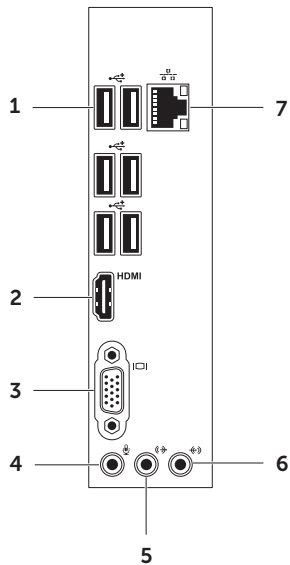

- 1 Back panel connectors** — Connect USB, audio, video, and other devices to the appropriate connectors.
- 2 Expansion card slots** — Provide access to connectors on any installed PCI Express cards.
- 3 Power supply light** — Indicates power availability of the power supply.  
**NOTE:** The power supply light may not be available on all computers.
- 4 Voltage selector switch** — Allows you to select the voltage rating appropriate for your region.
- 5 Power connector** — Connects to the power cable. The appearance of this connector may vary.
- 6 Security cable slot** — Allows you to attach a commercially available security cable to the computer.  
**NOTE:** Before you buy a security cable, ensure that it fits into the security cable slot on your computer.
- 7 Padlock rings** — Allows you to attach a standard padlock to prevent unauthorized access to the interior of your computer.

## Back Panel Connectors





-  **USB 2.0 connectors (6)** — Connect to USB devices, such as a mouse, keyboard, printer, external drive, or MP3 player.
-  **HDMI connector** — Connects to the HDMI connector on your display or TV.
-  **VGA connector** — Connects to a monitor or projector.
-  **Microphone connector** — Connects to a microphone for voice or to an audio cable for audio input.
-  **Front L/R line-out connector** — Connects to front L/R speakers.
-  **Line-in connector** — Connects to recording or playback devices such as a microphone, cassette player, CD player, or VCR.
-  **Network connector and light** — Connects your computer to a network or a broadband device if you are using a wired network. The two lights next to the connector indicate the status and activity for a wired network connection.

## Software Features

### Productivity and Communication

You can use your computer to create presentations, brochures, greeting cards, fliers, and spreadsheets. You can also edit and view digital photographs and images. Check your purchase order for software installed on your computer.



After connecting to the Internet, you can access websites, setup an e-mail account, and upload or download files.

### Entertainment and Multimedia

You can use your computer to watch videos, play games, create your own CDs/DVDs/Blu-ray Discs (optional), listen to music and radio stations. Your optical disc drive may support multiple disc media formats including CDs, DVDs, and Blu-ray Discs (optional).

You can download or copy pictures and video files from portable devices, such as digital cameras and cell phones. Optional software applications enable you to organize and create music and video files that can be recorded to a disc, saved on portable products such as MP3 players and handheld entertainment devices, or played and viewed directly on connected TVs, projectors, and home theater equipment.

## Dell DataSafe Online Backup

-  **NOTE:** Dell DataSafe Online may not be available in all regions.
-  **NOTE:** A broadband connection is recommended for fast upload/download speeds.

Dell DataSafe Online is an automated backup and recovery service that helps protect your data and other important files from catastrophic incidents like theft, fire, or natural disasters. You can access the service on your computer using a password-protected account. For more information, go to **DellDataSafe.com**.

To schedule backups:

1. Double-click the Dell DataSafe Online icon  in the notification area of your desktop.
2. Follow the instructions that appear on the screen.

## Dell Stage

The Dell Stage software provides access to your favorite media and multi-touch applications.

To launch Dell Stage, click **Start**  → **All Programs** → **Dell Stage** → **Dell Stage**.

-  **NOTE:** Some of the applications on Dell Stage can also be launched through the **All Programs** menu.

You can customize Dell Stage as follows:

- Rearrange an application shortcut — Select and hold the application shortcut until it blinks and then drag the application shortcut to a desired location on Dell Stage.
- Minimize — Drag the Dell Stage window to the bottom of the screen.
- Personalize — Select the settings icon and then choose the desired option.

## Using Your Inspiron Desktop

The following are the applications available on Dell Stage:



**NOTE:** Some of the applications may not be available based on the selections you made while purchasing your computer.

- **MUSIC** — Play music or browse through your music files by album, artist, or song title. You can also listen to Internet radio stations from across the globe. The optional Napster application allows you to download songs when connected to the Internet.
- **DOCUMENTS** — Provides quick access to the **Documents** folder on your computer.
- **PHOTO** — View, organize, or edit your pictures. You can create slideshows and collections of your pictures and upload them to **Facebook** or **Flickr** when connected to the Internet.
- **DELL WEB** — Provides a preview of up to four of your favorite web pages. Click or tap the web page preview to open it in the web browser.
- **VIDEO** — View videos. The optional CinemaNow application allows you to purchase or rent movies and TV shows when connected to the Internet.
- **SHORTCUTS** — Provides quick access to your frequently-used programs.
- **Web Tile** — Provides a preview of up to four of your favorite web pages. The tile allows you to add, edit, or delete a web page preview. Click the web page preview to open it in the web browser. You can also create multiple Web Tiles through the Apps Gallery.

# Solving Problems

This section provides troubleshooting information for your computer. If you cannot solve your problem using the following guidelines, see “Using Support Tools” on page 34 or “Contacting Dell” on page 57.



**WARNING:** Only trained service personnel should remove the computer cover. See the *Service Manual* at [support.dell.com/manuals](http://support.dell.com/manuals) for advanced service instructions.

## Beep Codes

Your computer might emit a series of beeps during start-up if there are errors or problems. This series of beeps, called a beep code, identifies a problem. If this occurs, write down the beep code and contact Dell (see “Contacting Dell” on page 57) for assistance.



**NOTE:** To replace parts, see the *Service Manual* at [support.dell.com/manuals](http://support.dell.com/manuals).

Beep Code	Possible Problem
One	Possible system board failure – BIOS ROM checksum failure
Two	No RAM detected <b>NOTE:</b> If you installed or replaced the memory module, ensure that the memory module is seated properly.
Three	Possible system board failure – Chipset error
Four	RAM read/write failure
Five	Real Time Clock failure
Six	Video card or chip failure
Seven	Processor failure

## Network Problems

### Wireless Connections

**If the network connection is lost** — The wireless router is offline or wireless has been disabled on the computer.

- Check your wireless router to ensure it is powered on and connected to your data source (cable modem or network hub).
- Re-establish your connection to the wireless router (see “Setting Up a Wireless Connection” on page 14).
- Interference may be blocking or interrupting your wireless connection. Try moving the computer closer to your wireless router.

### Wired Connections

**If the network connection is lost** — The network cable is loose or damaged.

- Check the network cable to ensure it is plugged in and not damaged.
- The link integrity light on the integrated network connector lets you verify that your connection is working and provides information on the status:
  - Green (left) — A good connection exists between a 10/100-Mbps network and the computer.
  - Amber (left) — A good connection exists between a 1000-Mbps network and the computer.
  - Off — The computer is not detecting a physical connection to the network.



**NOTE:** The link integrity light on the network connector is only for the wired connection. The link integrity light does not provide status for wireless connections.

## Power Problems

**If the power light is off** — The computer is in hibernate mode, turned off, or is not receiving power.

- Press the power button. The computer resumes normal operation if it is off or in hibernate mode.
- Reseat the power cable into the power connector on the computer and the electrical outlet.
- If the computer is plugged into a power strip, ensure that the power strip is plugged into an electrical outlet and that the power strip is turned on.
- Temporarily bypass power protection devices, power strips, and power extension cables to verify that the computer turns on properly.
- Ensure that the electrical outlet is working by testing it with another device, such as a lamp.

- Ensure that the power supply light on the back of the computer is on. If the light is off there may be a possible problem with the power supply or the power cable.
- If the problem persists, contact Dell (see “Contacting Dell” on page 57).

**If the power light is solid white and the computer is not responding** — The display may not be connected or powered on.

- Ensure that the display is properly connected and then turn it off, then back on.
- If the problem persists, contact Dell (see “Contacting Dell” on page 57).

**If the power light is solid amber** —

The computer is in sleep/standby mode or there might be a problem with the system board or the power supply.

- Press a key on the keyboard, move the connected mouse, or press the power button to resume normal operation.
- If the problem persists, contact Dell (see “Contacting Dell” on page 57).

## Solving Problems

**If the power light is blinking amber** — The computer has detected an error during POST. There might be a problem with the system board or the power supply. For assistance, contact Dell (see “Contacting Dell” on page 57).

**If you encounter interference that hinders reception on your computer** — An unwanted signal is creating interference by interrupting or blocking other signals. Some possible causes of interference are:

- Power, keyboard, and mouse extension cables.
- Too many devices connected to a power strip.
- Multiple power strips connected to the same electrical outlet.

## Memory Problems

**If you receive an insufficient memory message** —

- Save and close any open files and exit any open programs you are not using to see if that resolves the problem.
- See the software documentation for minimum memory requirements. If necessary, install additional memory (see the *Service Manual* at [support.dell.com/manuals](http://support.dell.com/manuals)).
- Reseat the memory modules (see the *Service Manual* at [support.dell.com/manuals](http://support.dell.com/manuals)) to ensure that your computer is successfully communicating with the memory.
- If the problem persists, contact Dell (see “Contacting Dell” on page 57).



**If you experience other memory problems —**

- Ensure that you are following the memory installation guidelines (see the *Service Manual* at [support.dell.com/manuals](http://support.dell.com/manuals)).
- Check if the memory module is compatible with your computer. Your computer supports DDR3 memory. For more information about the type of memory supported by your computer, see “Specifications” on page 60.
- Run Dell Diagnostics (see “Dell Diagnostics” on page 38).
- Reseat the memory modules (see the *Service Manual* at [support.dell.com/manuals](http://support.dell.com/manuals)) to ensure that your computer is successfully communicating with the memory.
- If the problem persists, contact Dell (see “Contacting Dell” on page 57).

## Lockups and Software Problems

**If the computer does not start up —** Ensure that the power cable is firmly connected to the computer and to the electrical outlet.

**If a program stops responding —** End the program:

1. Press <Ctrl><Shift><Esc> simultaneously.
2. Click **Applications**.
3. Click the program that is no longer responding.
4. Click **End Task**.

**If a program crashes repeatedly —** Check the software documentation. If necessary, uninstall and then reinstall the program.



**NOTE:** Software usually includes installation instructions in its documentation or on CD.

## Solving Problems

If the computer stops responding or a solid blue screen appears —

 **CAUTION: You might lose data if you are unable to perform an operating system shutdown.**

If you are unable to get a response by pressing a key on your keyboard or moving your mouse, press and hold the power button for at least 8 to 10 seconds until the computer turns off and then restart your computer.

If a program is designed for an earlier Microsoft Windows operating system —

Run the Program Compatibility Wizard. The Program Compatibility Wizard configures a program so that it runs in an environment similar to an earlier version of Microsoft Windows operating system.

To run the Program Compatibility Wizard:

1. Click **Start**  → **Control Panel** → **Programs** → **Run programs made for previous versions of Windows**.
2. In the welcome screen, click **Next**.
3. Follow the instructions on the screen.

### If you have other software problems —

- Back up your files immediately.
- Use a virus-scanning program to check the hard drive or CDs.
- Save and close any open files or programs and shut down your computer through the **Start**  menu.
- Check the software documentation or contact the software manufacturer for troubleshooting information:
  - Ensure that the program is compatible with the operating system installed on your computer.
  - Ensure that your computer meets the minimum hardware requirements needed to run the software. See the software documentation for information.
- Ensure that the program is installed and configured properly.
- Verify that the device drivers do not conflict with the program.
- If necessary, uninstall and then reinstall the program.
- Write down any error message that is displayed to help in troubleshooting when contacting Dell.

# Using Support Tools

## Dell Support Center

**All the support you need – one convenient location.**

The **Dell Support Center** provides system alerts, performance improvement offers, system information, and links to other Dell tools and diagnostic services.

To launch the application, click **Start**  → **All Programs** → **Dell** → **Dell Support Center** → **Launch Dell Support Center**.

The **Dell Support Center** home page displays your computer's model number, service tag, express service code, warranty status, and alerts on improving the performance of your computer.

The home page also provides links to access:

**PC Checkup** — Run hardware diagnostics, see which program occupies the maximum memory on your hard drive, and track the changes made to your computer each day.

### PC Checkup Utilities

- **Drive Space Manager** — Manage your hard drive using a visual representation of space consumed by each type of file.
- **Performance and Configuration History** — Monitor system events and changes over time. This utility displays all hardware scans, tests, system changes, critical events and restoration points on the day they occurred.

**Detailed System Information** — View detailed information about your hardware and operating system configurations; access copies of your service contracts, warranty information, and warranty renewal options.

**Get Help** — View Dell Technical Support options, Customer Support, Tours and Training, Online Tools, Owner's Manual, Warranty Information, FAQs, and so on.

**Backup and Recovery** — Create recovery media, launch recovery tool, and online file backup.

### **System Performance Improvement**

**Offers**— Acquire software and hardware solutions that will help improve your system performance.

For more information about **Dell Support Center** and to download and install the available support tools, go to **DellSupportCenter.com**.

## My Dell Downloads

 **NOTE:** My Dell Downloads may not be available in all regions.

Some of the software pre-installed on your new Dell computer do not include a backup CD or DVD. This software is available on the My Dell Downloads website. From this website you can download available software for reinstallation or create your own backup media.

To register and use My Dell Downloads:

1. Go to **DownloadStore.dell.com/media**.
2. Follow the instructions on the screen to register and download the software.
3. Reinstall the software or create a backup media for future use.

# System Messages

If your computer has an issue or error, it may display a system message that will help you identify the cause and action needed to resolve the issue.

 **NOTE:** If the message that appeared is not listed in the following examples, see the documentation for either the operating system or the program that was running when the message appeared or contact Dell (see “Contacting Dell” on page 57) for assistance.

**Alert! Previous attempts at booting this system have failed at checkpoint [nnnn]. For help in resolving this problem, please note this checkpoint and contact Dell Technical Support** — The computer failed to complete the boot routine three consecutive times for the same error. Contact Dell (see “Contacting Dell” on page 57) for assistance.

**CMOS checksum error or RTC is reset, BIOS Setup default has been loaded**— Possible system board failure or RTC battery low. Replace the battery (see the *Service Manual* at [support.dell.com/manuals](http://support.dell.com/manuals)) or Contact Dell (see “Contacting Dell” on page 57) for assistance.

**CPU fan failure** — CPU fan has failed. CPU fan needs replacement. See the *Service Manual* at [support.dell.com/manuals](http://support.dell.com/manuals).

**Hard-disk drive failure** — Possible hard-disk drive failure during POST. Contact Dell (see “Contacting Dell” on page 57) for assistance.

**Hard-disk drive read failure** — Possible hard-disk drive failure during HDD boot test. Contact Dell (see “Contacting Dell” on page 57) for assistance.

**Keyboard failure** — Replace the keyboard or check the cable for loose connection.

**No boot device available** — No bootable partition on hard drive, the hard drive cable is loose, or no bootable device exists.

- If the hard drive is your boot device, ensure that the cables are connected and that the drive is installed properly and partitioned as a boot device.
- Enter system setup and ensure that the boot sequence information is correct (see the *Service Manual* at [support.dell.com/manuals](http://support.dell.com/manuals)).

**No timer tick interrupt** — A chip on the system board might be malfunctioning or there might be a system board failure (see the *Service Manual* at [support.dell.com/manuals](http://support.dell.com/manuals)) or Contact Dell (see “Contacting Dell” on page 57) for assistance.

**USB over current error** — Disconnect the USB device. Your USB device needs more power for it to function properly. Use an external power source to connect the USB device, or if your device has two USB cables, connect both of them.

**CAUTION - Hard Drive SELF MONITORING SYSTEM has reported that a parameter has exceeded its normal operating range. Dell recommends that you back up your data regularly. A parameter out of range may or may not indicate a potential hard drive problem** — S.M.A.R.T error, possible hard drive failure. Contact Dell (see “Contacting Dell” on page 57) for assistance.

### Hardware Troubleshooter

If a device is either not detected during the operating system setup or is detected but incorrectly configured, you can use the **Hardware Troubleshooter** to resolve the incompatibility.

To start the Hardware Troubleshooter:

1. Click **Start**  → **Help and Support**.
2. Type `hardware troubleshooter` in the search field and press <Enter> to start the search.
3. In the search results, select the option that best describes the problem and follow the remaining troubleshooting steps.

### Dell Diagnostics

If you experience a problem with your computer, perform the checks in “Lockups and Software Problems” on page 31 and run Dell Diagnostics before you contact Dell for technical assistance.

Ensure that the device you want to test displays in the system setup utility and is active. To enter the system setup (BIOS) utility, turn on (or restart) your computer and press <F2> when the DELL logo appears.



## Starting Dell ePSA Diagnostics

Enhanced Pre-boot System Assessment (ePSA) tests devices such as the system board, keyboard, display, memory, hard drive, and so on.

1. Turn on (or restart) your computer.
2. When the DELL logo appears, press <F12> immediately.

 **NOTE:** If you wait too long and the operating system logo appears, continue to wait until you see the Microsoft Windows desktop; then, shut down your computer and try again.

3. Select **Diagnostics** from the boot menu and press <Enter>.
4. Follow the instructions on the screen.

If a device fails a test, the test stops and the computer beeps. Write down the error code(s) that appear on the screen and contact Dell (see “Contacting Dell” on page 57) for assistance.

- To stop ePSA and restart your computer, press <n>.
- To continue to the next test, press <y>.
- To re-run the failed test, press <r>.



If ePSA completes successfully, the following message appears “Do you want to run the remaining memory tests? This will take about 30 minutes or more. Do you want to continue? (Recommended).”

If you are experiencing memory issues, press <y>, otherwise press <n>. The following message is displayed: “Enhanced Pre-boot System Assessment Complete.”

5. Click **Exit** to restart your computer.

### Starting Dell PC Checkup

Dell PC Checkup scans and tests your computer hardware. It provides automated fixes for common configuration issues.

1. Click **Start**  → **All Programs** → **Dell** → **Dell Support Center** → **Launch PC Checkup**.
2. Select the test you want to run and follow the instructions on the screen.  
 **NOTE:** If a failure is reported after the tests complete, make note of the device(s) and the test(s) it failed. Contact Dell (see "Contacting Dell" on page 57) for assistance.
3. Close the window to exit PC Checkup.

# Restoring Your Operating System

You can restore the operating system on your computer using any of the following options:

 **CAUTION:** Using Dell Factory Image Restore or the *Operating System* disc to restore your operating system permanently deletes all data files on your computer. If possible, backup your data files before using these options.

Option	Use
System Restore	as the first solution
Dell DataSafe Local Backup	when System Restore does not resolve your problem
System recovery media	when operating system failure prevents the use of System Restore and DataSafe Local Backup when installing the Dell factory-installed software on a newly installed hard drive
Dell Factory Image Restore	to restore your computer to the operating state it was in when you received your computer
<i>Operating System</i> disc	to reinstall only the operating system on your computer



 **NOTE:** The *Operating System* disc may not ship with your computer.

# System Restore

The Microsoft Windows operating systems provide a System Restore option which allows you to return your computer to an earlier operating state (without affecting data files) if changes to the hardware, software, or other system settings have left the computer in an undesirable operating state. Any changes that System Restore makes to your computer are completely reversible.

 **CAUTION: Make regular backups of your data files. System Restore does not monitor your data files or recover them.**

## Starting System Restore

1. Click **Start** .
2. In the search box, type `System Restore` and press <Enter>.  
 **NOTE:** The **User Account Control** window may appear. If you are an administrator on the computer, click **Continue**; otherwise, contact your administrator to continue the desired action.
3. Click **Next** and follow the instructions on the screen.

In the event that System Restore did not resolve the issue, you may undo the last system restore.

## Undoing the Last System Restore

 **NOTE:** Before you undo the last system restore, save and close all open files and exit any open programs. Do not alter, open, or delete any files or programs until the system restoration is complete.

1. Click **Start** .
2. In the search box, type `System Restore` and press <Enter>.
3. Click **Undo my last restoration** and click **Next**.

## Dell DataSafe Local Backup

 **CAUTION:** Using Dell DataSafe Local Backup to restore your operating system permanently removes any programs or drivers installed after you received your computer. Create backup media of applications you need to install on your computer before using Dell DataSafe Local Backup. Use Dell DataSafe Local Backup only if System Restore did not resolve your operating system problem.

 **CAUTION:** Although Dell DataSafe Local Backup is designed to preserve the data files on your computer, it is recommended that you backup your data files before using the Dell DataSafe Local Backup.

 **NOTE:** Dell DataSafe Local Backup may not be available in all regions.

## Restoring Your Operating System

 **NOTE:** If Dell DataSafe Local Backup is not available on your computer, use Dell Factory Image Restore (see “Dell Factory Image Restore” on page 47) to restore your operating system.

You can use Dell DataSafe Local Backup to restore your hard drive to the operating state it was in when you purchased your computer, while preserving the data files.

Dell DataSafe Local Backup allows you to:

- Backup and restore your computer to an earlier operating state
- Create system recovery media (see “Create System Recovery Media (Recommended)” on page 12)

## Dell DataSafe Local Backup Basic

To restore your operating system and Dell factory-installed software while preserving the data files:

1. Turn off your computer.
2. Disconnect all the devices (USB drive, printer, and so on) connected to the computer and remove any newly added internal hardware.
3. Turn on your computer.
4. When the DELL logo appears, press <F8> several times to access the **Advanced Boot Options** window.

 **NOTE:** If you wait too long and the operating system logo appears, continue to wait until you see the Microsoft Windows desktop; then, shut down your computer and try again.
5. Select **Repair Your Computer**.

6. Select **Dell DataSafe Restore and Emergency Backup** from the **System Recovery Options** menu and follow the instructions on the screen.

 **NOTE:** The restoration process may take an hour or more depending on the size of the data to be restored.

 **NOTE:** For more information, see knowledge base article 353560 at [support.dell.com](https://support.dell.com).

## Upgrading to Dell DataSafe Local Backup Professional

 **NOTE:** Dell DataSafe Local Backup Professional may be installed on your computer, if you ordered it at the time of purchase.

Dell DataSafe Local Backup Professional provides additional features that allow you to:

- Backup and restore your computer based on file types
- Backup files to a local storage device
- Schedule automated backups

To upgrade to Dell DataSafe Local Backup Professional:

1. Double-click the Dell DataSafe Local Backup icon  in the notification area of your desktop.
2. Click **UPGRADE NOW!**
3. Follow the instructions on the screen.

# System Recovery Media

 **CAUTION:** Although the system recovery media is designed to preserve the data files on your computer, it is recommended that you backup your data files before using the system recovery media.

You can use the system recovery media, created using Dell DataSafe Local Backup, to return your hard drive to the operating state it was in when you purchased the computer while preserving the data files.

Use the system recovery media in case of:

- Operating system failure that prevents the use of the recovery options installed on your computer.
- Hard drive failure that prevents data from being recovered.

To restore the operating system and Dell factory-installed software on your computer using the system recovery media:

1. Insert the system recovery disc or USB key and restart the computer.
2. When the DELL logo appears, press <F12> immediately.

 **NOTE:** If you wait too long and the operating system logo appears, continue to wait until you see the Microsoft Windows desktop; then, shut down your computer and try again.

3. Select the appropriate boot device from the list and press <Enter>.
4. Follow the instructions on the screen.



## Dell Factory Image Restore

 **CAUTION:** Using Dell Factory Image Restore to restore your operating system permanently deletes all data on the hard drive and removes any programs or drivers installed after you received your computer. If possible, back up the data before using this option. Use Dell Factory Image Restore only if System Restore did not resolve your operating system problem.

 **NOTE:** Dell Factory Image Restore may not be available in certain countries or on certain computers.

 **NOTE:** If Dell Factory Image Restore is not available on your computer, use Dell DataSafe Local Backup (see “Dell DataSafe Local Backup” on page 43) to restore your operating system.

Use Dell Factory Image Restore only as the last method to restore your operating system. This option restores your hard drive to the operating state it was in when you purchased the computer. Any programs or files added since you received your computer—including data files—are permanently deleted from the hard drive. Data files include documents, spreadsheets, e-mail messages, digital photos, music files, and so on. If possible, back up all data before using Dell Factory Image Restore.

### Starting Dell Factory Image Restore

1. Turn on the computer.
2. When the DELL logo appears, press <F8> several times to access the **Advanced Boot Options** window.

 **NOTE:** If you wait too long and the operating system logo appears, continue to wait until you see the Microsoft Windows desktop; then, shut down your computer and try again.

## Restoring Your Operating System

**3. Select Repair Your Computer.**

The **System Recovery Options** window appears.

**4. Select a keyboard layout and click Next.**

**5. To access the recovery options, log on as a local user. To access the command prompt, type administrator in the User name field, then click OK.**

**6. Click Dell Factory Image Restore.**

The **Dell Factory Image Restore** welcome screen appears.

 **NOTE:** Depending upon your configuration, you may need to select **Dell Factory Tools**, then **Dell Factory Image Restore**.

**7. Click Next.**

The **Confirm Data Deletion** screen appears.

 **NOTE:** If you do not want to proceed with the Factory Image Restore, click **Cancel**.

**8. Select the check box to confirm that you want to continue to reformat the hard drive and restore the system software to the factory condition, then click Next.**

The restore process begins and may take five or more minutes to complete. A message appears when the operating system and factory-installed applications have been restored to factory condition.

**9. Click Finish to restart the computer.**

# Getting Help

If you experience a problem with your computer, you can complete the following steps to diagnose and troubleshoot the problem:

1. See “Solving Problems” on page 27 for information and procedures that pertain to the problem your computer is experiencing.
2. See “Dell Diagnostics” on page 38 for procedures on how to run Dell Diagnostics.
3. Fill out the “Diagnostic Checklist” on page 56.
4. Use Dell’s extensive suite of online services available at Dell Support ([support.dell.com](http://support.dell.com)) for help with installation and troubleshooting procedures. See “Online Services” on page 51 for a more extensive list of Dell Support online.
5. If the preceding steps have not resolved the problem, see “Before You Call” on page 55.



**NOTE:** Call Dell Support from a telephone near or at the computer so that the support staff can assist you with any necessary procedures.



**NOTE:** Dell’s Express Service Code system may not be available in all countries.

When prompted by Dell’s automated telephone system, enter your Express Service Code to route the call directly to the proper support personnel. If you do not have an Express Service Code, open the **Dell Accessories** folder, double-click the **Express Service Code** icon, and follow the directions.



**NOTE:** Some of the services are not always available in all locations outside the continental U.S. Call your local Dell representative for information on availability.

## Technical Support and Customer Service

Dell's support service is available to answer your questions about Dell hardware. Our support staff use computer-based diagnostics to provide fast, accurate answers.

To contact Dell's support service, see "Before You Call" on page 55 and then see the contact information for your region or go to **[support.dell.com](http://support.dell.com)**.

## DellConnect

DellConnect is a simple online access tool that allows a Dell service and support associate to access your computer through a broadband connection, diagnose your problem and repair it all under your supervision. For more information, go to **[www.dell.com/DellConnect](http://www.dell.com/DellConnect)**.

## Online Services

You can learn about Dell products and services on the following websites:

- **www.dell.com**
- **www.dell.com/ap** (Asian/Pacific countries only)
- **www.dell.com/jp** (Japan only)
- **www.euro.dell.com** (Europe only)
- **www.dell.com/la** (Latin American and Caribbean countries)
- **www.dell.ca** (Canada only)

You can access Dell Support through the following websites and e-mail addresses:

### Dell Support Websites

- **support.dell.com**
- **support.jp.dell.com** (Japan only)
- **support.euro.dell.com** (Europe only)
- **supportapj.dell.com** (Asia Pacific only)

### Dell Support E-mail Addresses

- **mobile\_support@us.dell.com**
- **support@us.dell.com**
- **la-techsupport@dell.com** (Latin America and Caribbean countries only)
- **apsupport@dell.com** (Asian/Pacific countries only)

### Dell Marketing and Sales E-mail Addresses

- **apmarketing@dell.com** (Asian/Pacific countries only)
- **sales\_canada@dell.com** (Canada only)

### Anonymous File Transfer Protocol (FTP)

- **ftp.dell.com**

Log in as user: `anonymous`, and use your e-mail address as your password.

## Automated Order-Status Service

To check on the status of any Dell products that you have ordered, you can go to **support.dell.com**, or you can call the automated order-status service. A recording prompts you for the information needed to locate and report on your order.

If you have a problem with your order, such as missing parts, wrong parts, or incorrect billing, contact Dell for customer assistance. Have your invoice or packing slip handy when you call.

For the telephone number to call for your region, see “Contacting Dell” on page 57.

## Product Information

If you need information about additional products available from Dell, or if you would like to place an order, go to **www.dell.com**.

For the telephone number to call for your region or to speak to a sales specialist, see “Contacting Dell” on page 57.

## Returning Items for Repair Under Warranty or for Credit

Prepare all items being returned, whether for repair or credit, as follows:

 **NOTE:** Before you return the product to Dell, ensure that you back up any data on the hard drive(s) and on any other storage device in the product. Remove any and all confidential, proprietary and personal information, as well as removable media, such as CDs and media cards. Dell is not responsible for any of your confidential, proprietary or personal information; lost or corrupted data; or damaged or lost removable media that may be included with your return.

1. Call Dell to obtain a Return Material Authorization Number, and write it clearly and prominently on the outside of the box. For the telephone number to call for your region, see “Contacting Dell” on page 57.
2. Include a copy of the invoice and a letter describing the reason for the return.
3. Include a copy of the Diagnostics Checklist (see “Diagnostic Checklist” on page 56), indicating the tests that you have run and any error messages reported by Dell Diagnostics (see “Dell Diagnostics” on page 38).
4. Include any accessories that belong with the item(s) being returned (AC adapter cable, software, guides, and so on) if the return is for credit.

## Getting Help

5. Pack the equipment to be returned in the original (or equivalent) packing materials.

 **NOTE:** You are responsible for paying shipping expenses. You are also responsible for insuring any product returned, and you assume the risk of loss during shipment to Dell. Collect On Delivery (C.O.D.) packages are not accepted.

 **NOTE:** Returns that are missing any of the preceding requirements will be refused at Dell's receiving dock and returned to you.



## Before You Call

**NOTE:** Have your Express Service Code ready when you call. The code helps Dell's automated-support telephone system direct your call more efficiently. You may also be asked for your Service Tag (located at the top of your computer).

### Locating Your Service Tag and Express Service Code

The Service Tag and Express Service Code for your computer can be found on a label at the top of your computer.

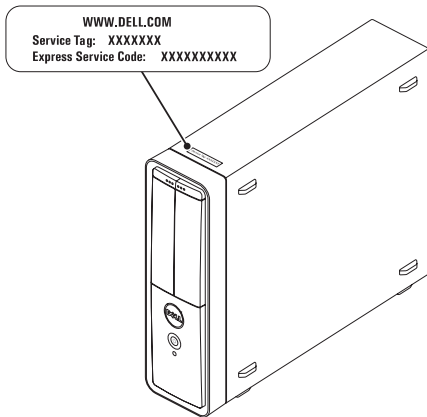

## Getting Help

Remember to fill out the following Diagnostics Checklist. If possible, turn on your computer before you call Dell for assistance and call from a telephone at or near the computer. You may be asked to type some commands at the keyboard, relay detailed information during operations, or try other troubleshooting steps possible only at the computer itself. Ensure that the computer documentation is available.

### Diagnostic Checklist

- Name:
- Date:
- Address:
- Phone number:
- Service Tag and Express Service Code (located on a label at the top of the computer):
- Return Material Authorization Number (if provided by Dell support technician):
- Operating system and version:
- Devices:
- Expansion cards:
- Are you connected to a network? Yes/No
- Network, version, and network adapter:
- Programs and versions:

See your operating system documentation to determine the contents of the computer's start-up files. If the computer is connected to a printer, print each file. Otherwise, record the contents of each file before calling Dell.

- Error message, beep code, or diagnostic code:
- Description of problem and troubleshooting procedures you performed:

## Contacting Dell

For customers in the United States, call 800-WWW-DELL (800-999-3355).

 **NOTE:** If you do not have an active Internet connection, you can find contact information on your purchase invoice, packing slip, bill, or Dell product catalog.

Dell provides several online and telephone-based support and service options. Availability varies by country and product, and some services may not be available in your area.

To contact Dell for sales, technical support, or customer service issues:

1. Go to **[www.dell.com/ContactDell](http://www.dell.com/ContactDell)**.
2. Select your country or region.
3. Select the appropriate service or support link based on your requirement.
4. Choose the method of contacting Dell that is convenient for you.

# Finding More Information and Resources

**If you need to:****See:**

---

reinstall your operating system

"System Recovery Media" on page 46

---

run a diagnostic program for your computer

"Dell Diagnostics" on page 38

---

reinstall system software

"My Dell Downloads" on page 35

---

for more information about the Microsoft Windows operating system and features

**support.dell.com**

---

upgrade your computer with new or additional components like a new hard drive

the *Service Manual* at  
**support.dell.com/manuals**

---

reinstall or replace a worn or defective part



**NOTE:** In some countries, opening and replacing parts of your computer may void your warranty. Check your warranty and return policies before working inside your computer.

---

### If you need to:

---

find safety best practices information for your computer

review Warranty information, Terms and Conditions (U.S. only), Safety instructions, Regulatory information, Ergonomics information, and End User License Agreement

---

find your Service Tag/Express Service Code — You must use the service tag to identify your computer on **support.dell.com** or to contact technical support

---

find drivers and downloads; readme files  
access technical support and product help  
check on your order status for new purchases  
find solutions and answers to common questions  
locate information for last-minute updates about technical changes to your computer or advanced technical-reference material for technicians or experienced users

---

### See:

---

the safety and regulatory documents that shipped with your computer and also see the Regulatory Compliance Homepage at **www.dell.com/regulatory\_compliance**

---

the top of your computer  
“Dell Support Center” on page 34



---

**support.dell.com**

---

# Specifications

This section provides information that you may need when setting up, updating drivers for, and upgrading your computer.

 **NOTE:** Offerings may vary by region. For more information regarding the configuration of your computer, see the **Detailed System Information** section in the Dell Support Center. To launch the Dell Support Center, click **Start**  → **All Programs** → **Dell** → **Dell Support Center** → **Launch Dell Support Center**.

## Computer Model

---

Dell Inspiron 620s

## Processor

---

Type	Intel Core i3
	Intel Core i5
	Intel Celeron
	Intel Pentium Dual Core

## System Chipset

---

Type	Intel H61
------	-----------

## Drives

---

Internally accessible	one 3.5-inch bay for SATA hard drive
Externally accessible	one 5.25-inch bay for tray-load SATA DVD+/-RW/Blu-ray Disc combo (optional)/Blu-ray Disc rewritable (optional)

## Memory

---

Memory module connectors	two user-accessible connectors
Memory module capacities	1 GB, 2 GB, and 4 GB
Memory type	1333 MHz DDR3 non-ECC memory only
Minimum memory	1 GB
Maximum memory	8 GB
Possible memory configurations	2 GB, 3 GB, 4 GB, 6 GB, and 8 GB

 **NOTE:** For instructions on upgrading the memory, see the *Service Manual* at [support.dell.com/manuals](http://support.dell.com/manuals).

## Audio

---

Audio controller	Integrated 5.1 channel; High Definition Audio
------------------	---

## Video

---

UMA	
Video controller	Intel HD Graphics
Discrete	
Video controller	AMD Radeon HD 6450

## Specifications

### Internal Connectors

---

PCI Express x1	three 36-pin connectors
PCI Express x16	one 164-pin connector
SATA	four 7-pin connectors

### External Connectors

---

#### Audio:

Front panel	one stereo headphones/ speakers connector and one microphone-in connector
Back panel	three connectors for 5.1 channel support
Network adapter	one RJ45 connector

### External Connectors

---

USB	two front-panel and six back-panel USB 2.0 compliant connectors
VGA	one 15-hole connector
HDMI	one 19-pin connector
Media Card Reader	one 8-in-1 card reader

### Battery

---

Type	3 V CR-2032 lithium coin-cell
------	----------------------------------



## Power

---

Power Supply	
Wattage	250 W
Input voltage	100-127 VAC/ 200-240 VAC
Input frequency	50/60 Hz
Input current	8 A/4 A

## Communication

---

Network adapter	10/100/1000 Ethernet LAN on system board
Wireless (optional)	Wi-Fi

## Physical

---

Height	369 mm (14.52 inches)
Width	110 mm (4.33 inches)
Depth	437 mm (17.20 inches)
Weight	7.50 kg (16.53 lb)

## Specifications

### Computer Environment

---

Temperature range:

Operating      10°C to 35°C  
                      (50°F to 95°F)

Storage          –40°C to 65°C  
                      (–40°F to 149°F)

Relative humidity   20% to 80%  
(maximum)          (noncondensing)

Maximum shock (for operating — measured with Dell Diagnostics running on the hard drive and a 2-ms half-sine pulse; for non-operating — measured with the hard drive in head-parked position and a 2-ms half-sine pulse):

Operating          40 G for 2 ms with a  
                          change in velocity of  
                          20 in/s (51 cm/s)

Non-  
Operating          105 G for 2 ms with a  
                          change in velocity of  
                          50 in/s (127 cm/s)

### Computer Environment

---

Maximum vibration (using a random vibration spectrum that simulates user environment):

Operating          0.25 GRMS

Non-                2.20 GRMS

Operating

Altitude (maximum):

Operating          –15.2 to 3048 m  
                          (–50 to 10,000 ft)

Storage            –15.2 to 10,668 m  
                          (–50 to 35,000 ft)

Airborne  
contaminant  
level                G2 or lower as defined  
                          by ISA-S71.04-1985

# Appendix

## Information for NOM, or Official Mexican Standard (Only for Mexico)

The following information is provided in the device(s) described in this document in accordance with the requirements of the Official Mexican Standard (NOM):

**Importer:**

Dell México S.A. de C.V.

Paseo de la Reforma 2620 – Flat 11°

Col. Lomas Altas

11950 México, D.F.

<b>Regulatory Model Number</b>	<b>Regulatory Type</b>	<b>Input Voltage</b>	<b>Input Frequency</b>	<b>Rated Output Current</b>
D06D	D06D001	115/230 VAC	50/60 Hz	5 A/1.8 A 6 A/3 A

For details, read the safety information that shipped with your computer.

For additional safety best practices information, see [www.dell.com/regulatory\\_compliance](http://www.dell.com/regulatory_compliance).

# Index

## A

adapter **6**

Advanced Graphic Configuration **6**

## B

Back panel connectors **21**

Backup and Recovery

    backup **35**

    local **35**

beep code **27**

## C

calling Dell **55**

CDs, playing and creating **24**

computer capabilities **24**

connect(ing)

    display **6**

    optional network cable **9**

    to the Internet **13**

Contacting Dell online **57**

customer service **50**

## D

DataSafe Local Backup **43**

DellConnect **50**

Dell Factory Image Restore **47**

Dell Stage **25**

Diagnostic Checklist **56**

drivers and downloads **59**

DVDs, playing and creating **24**

**E**

- e-mail addresses
  - for technical support **51**
- Ethernet cable **9**

**F**

- finding more information **58**
- front-side connectors **16**
- FTP login, anonymous **51**

**H**

- hard drive activity light **18**
- hardware problems
  - diagnosing **38**
- Hardware Troubleshooter **38**
- HDMI connector **23**
- help
  - getting assistance and support **49**

**I**

- Internet connection **13**
- ISP
  - Internet Service Provider **13**

**K**

- Keyboard failure **36**

**L**

- Line-in connector **23**

**M**

- memory problems
  - solving **30**

**N**

- network connection
  - fixing **28**
- network connector
  - location **23**

## Index

### O

Online backup **25**

### P

problems, solving **27**

products

    information and purchasing **52**

### R

resources, finding more **58**

restoring factory image **47**

### S

security cable slot **21**

Service Tag **55**

shipping products

    for return or repair **53**

software features **24**

software problems **31**

solving problems **27**

specifications **60**

support e-mail addresses **51**

support sites

    worldwide **51**

System Messages **36**

System Recovery Media **46**

system reinstall options **41**

System Restore **42**

### T

TV tuner **13**

### U

USB 2.0

    back connectors **23**

    front connectors **17**

## V

VGA cable

    Connectivity **7**

Voltage selector switch **21**

## W

warranty returns **53**

Windows

    Program Compatibility Wizard **32**

wireless network connection **28**

