

# Dell™ PowerVault™ 110T LTO-3 Tape Drive User's Guide

---

The information below is provided by the supplier of the referenced device without independent verification by Dell and is subject to the [restrictions and disclaimers](#) noted below.

---

[Introduction](#)  
[Setting Up the Tape Drive](#)  
[Using the Tape Drive](#)  
[Using the Tape Backup Software](#)  
[Troubleshooting](#)  
[Specifications](#)  
[Glossary](#)

---



**NOTE:** A NOTE indicates important information that helps you make better use of your system.



**NOTICE:** A NOTICE indicates either potential damage to hardware or loss of data and tells you how to avoid the problem.



**CAUTION:** A CAUTION indicates a potential for property damage, personal injury, or death.

**Information in this document is subject to change without notice.**  
© 2005 Dell Inc. All rights reserved.  
© International Business Machines Corporation, 2005. All rights reserved.

Trademarks used in this text: *Dell*, *PowerVault*, and the *DELL* logo are trademarks of Dell Inc. *Microsoft* and *Windows* are registered trademarks of Microsoft Corporation.

Other trademarks and trade names may be used in this document to refer to either the entities claiming the marks and names or their products. Dell Inc. disclaims any proprietary interest in trademarks and trade names other than its own.

---

## Restrictions and Disclaimers

The information contained in this document, including all instructions, cautions, and regulatory approvals and certifications, is provided by the supplier and has not been independently verified or tested by Dell. Dell cannot be responsible for damage caused as a result of either following or failing to follow these instructions.

All statements or claims regarding the properties, capabilities, speeds, or qualifications of the part referenced in this document are made by the supplier and not by Dell. Dell specifically disclaims knowledge of the accuracy, completeness, or substantiation for any such statements. All questions or comments relating to such statements or claims should be directed to the supplier.

---

Model Number LTO3-EX1

---

*Initial release: May 2005*

## Glossary: Dell™ PowerVault™ 110T LTO-3 Tape Drive User's Guide

[A](#) - [B](#) - [C](#) - [D](#) - [E](#) - [F](#) - [G](#) - [H](#) - [I](#) - [J](#) - [L](#) - [M](#) - [N](#) - [O](#) - [P](#) - [R](#) - [S](#) - [T](#) - [U](#) - [V](#) - [W](#)

---

### Numbers

**2:1 compression.** The relationship between the quantity of data that can be stored with compression as compared to the quantity of data that can be stored without compression. In 2:1 compression, twice as much data can be stored with compression as can be stored without compression.

### A

**A.** See **ampere**.

**ampere (A).** A unit of measure for electric current that is equivalent to a flow of one coulomb per second, or equivalent to the current produced by one volt applied across a resistance of one ohm.

**adapter.** See **adapter card**.

**adapter card.** A circuit board that adds function to a computer.

### B

**backups.** The short-term retention of records used for restoring essential business and server files when vital data has been lost because of program or server errors or malfunctions.

**backward compatible.** Capable of being used with a previous product that was designed for a similar purpose. For example, a tape cartridge that is designed to be used with a modern tape drive but can also be used with certain older tape drives. Synonymous with *downward compatible*.

**bezel.** The removable frame that fits over the front of the tape drive.

**burst data transfer rate.** The maximum speed at which data is transferred.

**byte.** A string that consists of a certain number of bits (usually 8) which are treated as a unit and represent a character. A byte is a fundamental unit of data.

### C

**C.** See **Celsius**.

**capacity.** The amount of data that can be contained on storage media and expressed in bytes.

**cartridge.** See **tape cartridge**.

**cartridge door.** On a tape cartridge, the hinged barrier that can be opened to access, or closed to protect, the magnetic tape within the cartridge.

**cartridge memory.** See **LTO cartridge memory**.

**Celsius (C).** Having a thermostatic scale on which the interval between the freezing point and the boiling point of water is divided into 100 degrees, with 0 degrees representing the freezing point and 100 degrees representing the boiling point.

**cleaning cartridge.** A tape cartridge that is used to clean the heads of a tape drive. Contrast with *data cartridge*.

**clockwise.** In the direction that the hands of a clock rotate, as viewed from the front.

**compression.** The process of eliminating gaps, empty fields, redundancies, and unnecessary data to shorten the length of records or blocks.

**configure.** To describe to a server the devices, optional features, and programs installed on the system.

**counterclockwise.** In a direction opposite to that in which the hands of a clock rotate, as viewed from the front.

**current.** The quantity of charge per unit of time. Current is measured in amperes.

**cycle power.** To apply and remove electrical power to a device within a short time span.

### D

**data.** Any representations such as characters or analog quantities to which meaning is, or might be, assigned.

**data cartridge.** A tape cartridge that is dedicated to storing data. Contrast with cleaning cartridge.

**data compression.** See **compression**.

**data transfer rate.** The average number of bits, characters, or blocks per unit of time that pass between corresponding equipment in a data transmission system. The rate is expressed in bits, characters, or blocks per second, minute, or hour.

**DC.** See **direct current**.

**degauss.** To make a magnetic tape nonmagnetic by exposing the tape to electrical coils which carry currents that neutralize the magnetism of the tape.

**device.** Any hardware component or peripheral, such as a tape drive or tape library, that can receive and send data.

**device driver.** A file that contains the firmware that is needed to use an attached device.

**diagnostic.** A software program that is designed to recognize, locate, and explain faults in equipment or errors in programs.

**direct current (DC).** An electric current flowing in one direction only and substantially constant in value.

**drive.** A data-storage device that controls the movement of the magnetic tape in a tape cartridge. The drive houses the mechanism (drive head) that reads and writes data to the tape.

**drive dump.** The recording, at a particular instant, of the contents of all or part of one storage device into another storage device, usually as a safeguard against faults or errors, or in connection with debugging.

**drive head.** The component that records an electrical signal onto magnetic tape, or reads a signal from tape into an electrical signal.

**drive sense data.** See **SCSI drive sense data**.

**dump.** See **drive dump**.

## E

**eject.** To remove or force out from within.

**enclosure.** A device, such as a desktop unit, tape cartridge autoloader, or tape library, into which you can install the tape drive.

**error log.** Maintained by the tape drive, a list that contains the ten most recent error codes. The codes identify errors that pertain to the drive.

## F

**F.** See **Fahrenheit**.

**Fahrenheit (F).** Of or relating to a temperature scale that registers the freezing point of water as 32 degrees and the boiling point as 212 degrees at one atmosphere of pressure.

**file.** A named set of records that are stored or processed as a unit.

**firmware.** The proprietary code that is usually delivered as part of an operating system. Firmware is more efficient than software that is loaded from an alterable medium, and is more adaptable to change than pure hardware circuitry. An example of firmware is the Basic Input/Output System (BIOS) in read-only memory (ROM) on a PC motherboard.

## G

**GB.** See **gigabyte**.

**Generation 1.** The informal name for the Ultrium tape drive, which is the predecessor of the tape drive (Generation 2). The Generation 1 drive has a native storage capacity of up to 100 GB per cartridge and a native sustained data transfer rate of 15 MB per second.

**Generation 2.** The informal name for the Ultrium 2 Tape Drive, which is the second-generation version of the Ultrium tape drive (Generation 1). The Generation 2 drive has a native storage capacity of up to 200 GB per cartridge and a native sustained data transfer rate of 35 MB per second.

**Generation 3.** The informal name for the Ultrium 3 Tape Drive, which is the third-generation version of the Ultrium tape drive (Generation 1, 2). The Generation 3 drive has a native storage capacity of up to 400 GB per cartridge and a native sustained data transfer rate of 80 MB per second.

**gigabyte.** 1,000,000,000 bytes.

**ground.** An object that makes an electrical connection with the earth.

## H

**hardware.** The physical equipment or devices that form a computer.

**head.** See **drive head**.

**Head Resistance Measurements test.** Part of the Test Head diagnostic, a procedure that determines whether the tape drive's head works correctly. The test measures the head's ability to withstand cracks and other defects.

**host.** The controlling or highest-level system in a data communication configuration. Synonymous with *server*.

## I

**ID.** Identifier.

**in.** See **inch**.

**inch.** A unit of length equal to 1/36 yard or 25.4 mm.

**input/output (I/O).** Data that is provided to a computer or data that results from computer processing.

**insertion guide.** On the surface of the tape cartridge, a large, notched area that prevents you from inserting the cartridge incorrectly.

**install.** (1) To set up for use or service. (2) The act of adding a product, feature, or function to a server or device either by a singular change or by the addition of multiple components or devices.

**interposer.** An adapter-like device that allows a connector of one size and style to connect to a mating connector of a different size and style. Data provided to the computer or data resulting from computer processing.

**I/O.** See **input/output**.

## J

**jumper.** (1) A tiny connector that fits over a pair of protruding pins in a connector. A jumper can be moved to change electrical connectors. When in place, the jumper connects the pins electrically.  
(2) To place a jumper on a connector pin.

## L

**label.** A slip of paper with an adhesive backing that can be written on and affixed to a tape cartridge as a means of identification or description.

**label area.** On the LTO Ultrium Tape Cartridge, a recessed area next to the write-protect switch where a bar code label must be affixed.

**leader block.** Located within the tape drive, the part that engages the steel pin which is attached to the tape in an LTO Ultrium Tape Cartridge. Once engaged, the leader-pin block pulls the tape from the cartridge into the drive.

**leader pin.** On the tape cartridge, a small metal column that is attached to the end of the magnetic tape. During tape processing the leader pin is grasped by a threading mechanism, which pulls the pin and the tape out of the cartridge, across the drive head, and onto a takeup reel. The head can then read or write data from or to the tape.

**LED.** See **light-emitting diode**.

**light-emitting diode.** A semiconductor diode that emits light when subjected to an applied voltage and that is used in an electronic display.

**Linear Tape-Open (LTO).** A type of tape storage technology developed by the IBM Corporation, Hewlett-Packard, and Seagate. LTO technology is an "open format" technology, which means that its users have multiple sources of product and media. The "open" nature of LTO technology enables compatibility between different vendors' offerings by ensuring that vendors comply with verification standards.

**load.** Following the insertion of a tape cartridge into the tape load compartment, the act of positioning the tape (performed by the tape drive) for reading or writing by the drive's head.

**log sense data.** See **SCSI log sense data**.

**loop.** (1) A series of instructions that is repeated until a terminating condition is reached.  
(2) To connect so as to complete a loop.

**Low Voltage Differential (LVD).** A low-noise, low-power, and low-amplitude electrical signaling system that enables data communication between a supported server and the tape drive. LVD signaling uses two wires to drive one signal over copper wire. The use of wire pairs reduces electrical noise and crosstalk.

**LTO.** See **Linear Tape-Open**.

**LVD.** See **Low Voltage Differential**.

## M

**magnetic tape.** A tape with a magnetizable surface layer on which data can be stored by magnetic recording.

**maintenance mode.** The state of operation in which the tape drive must be before it can run diagnostics, verify write and read operations, verify a suspect tape cartridge, update its own firmware, and perform other diagnostic and maintenance functions.

**MB.** See **megabyte**.

**media.** The plural of *medium*.

**medium.** A physical material in or on which data may be represented, such as magnetic tape.

**megabyte (MB).** 1,000,000 bytes.

## N

**network.** A configuration of data processing devices and software that is connected for information interchange.

## O

**oersted.** The unit of magnetic field strength in the unrationalized centimeter-gram-second (cgs) electromagnetic system. The oersted is the magnetic field strength in the interior of an elongated, uniformly wound solenoid that is excited with a linear current density in its winding of one ampere per 4 pi centimeters of axial length.

**offline.** The operating condition that the tape drive is in when the server's applications cannot interact with it.

**online.** The operating condition that the tape drive is in when the server's applications can interact with it.

**Open Systems.** Computer systems whose standards are not proprietary.

**operating environment.** The temperature, relative humidity rate, and wet bulb temperature of the room in which the tape drive routinely conducts processing.

## P

**parity.** The state of being even-numbered or odd-numbered. A parity bit is a binary number that is added to a group of binary numbers to make the sum of that group always odd (odd parity) or even (even parity).

**parity error.** A transmission error that occurs when the received data does not have the parity that is expected by the receiving system. This usually occurs when the sending and receiving systems have different parity settings.

**port.** (1) A system or network access point for data entry or exit.  
(2) A connector on a device to which cables for other devices such as display stations and printers are attached.  
(3) The representation of a physical connection to hardware. A port is sometimes referred to as an adapter; however, there can be more than one port on an adapter.

**power connector.** Located at the rear of the tape drive, the connector to which the internal power cable of an enclosure connects.

**power cord.** A cable that connects a device to a source of electrical power.

**power-off.** To remove electrical power from a device.

**power-on, powered-on.** (1) To apply electrical power to a device.  
(2) The state of a device when power has been applied to it.

## R

**read.** To acquire or interpret data from a storage device, from a data medium, or from another source.

**reboot.** To reinitialize the execution of a program by repeating the initial program load (IPL) operation.

**record.** The smallest distinct set of data bytes that is supplied from a server for processing and recording by a tape drive, and the smallest distinct set of data to be read from tape, reprocessed, and made available to a server by a tape drive.

**relative humidity.** The ratio of the amount of water vapor actually present in the air to the greatest amount possible at the same temperature.

**reset.** To return a device or circuit to a clear state.

## S

**scratch cartridge.** A data cartridge that contains no useful data, but can be written to with new data.

**SCSI.** See **Small Computer Systems Interface.**

**SCSI bus.** (1) A collection of wires through which data is transmitted from one part of a computer to another.  
(2) A generic term that refers to the complete set of signals that define the activity of the Small Computer Systems Interface (SCSI).

**SCSI connector.** Located at the rear of the tape drive, the connector that facilitates commands to and from the server, and to which the internal SCSI cable of an enclosure connects.

**SCSI device.** Anything that can connect into the SCSI bus and actively participate in bus activity.

**SCSI drive sense data.** In response to inquiry from the server about an error condition, a packet of SCSI sense bytes that contains information about the error and that is sent back to the server by the drive.

**SCSI ID.** The unique address (from 1 to 15) that you assign to a tape drive that uses a SCSI interface.

**SCSI ID connector.** Located at the rear of the tape drive, the connector that enables the drive's SCSI address to be set. Addresses are determined by the placement of jumpers on the pins.

**SCSI interface.** See **Small Computer Systems Interface**.

**SCSI log sense data.** In response to inquiry from the server about the tape drive's error logs and counters, a packet of SCSI sense bytes which contains that information and which is sent back to the server by the drive. Log sense data is used to diagnose problems, especially if the problems are intermittent.

**second.** One sixtieth of a minute.

**sense data.** Data that describes an I/O error. Sense data is presented to a server in response to a Sense I/O command.

**server.** A functional unit that provides services to one or more clients over a network. Examples include a file server, a print server, or a mail server. The IBM pSeries, IBM iSeries, HP, and Sun are servers. Synonymous with host.

**single-character display.** Located at the front of the tape drive, an LED that presents an alphabetical or numeric code which represents a diagnostic or maintenance function, error condition, or informational message.

**sleep mode.** A power-management function that causes the tape drive's electronics to automatically enter a low-power mode by which to conserve energy.

**Small Computer Systems Interface (SCSI).** A standard used by computer manufacturers for attaching peripheral devices (such as tape drives, hard disks, CD-ROM players, printers, and scanners) to computers (servers). Pronounced "scuzzy." Variations of the SCSI interface provide for faster data transmission rates than standard serial and parallel ports (up to 160 megabytes per second). The variations include:

- 1 Fast/Wide SCSI: Uses a 16-bit bus, and supports data rates of up to 20 MBps.
- 1 SCSI-1: Uses an 8-bit bus, and supports data rates of 4 MBps.
- 1 SCSI-2: Same as SCSI-1, but uses a 50-pin connector instead of a 25-pin connector, and supports multiple devices.
- 1 Ultra SCSI: Uses an 8- or 16-bit bus, and supports data rates of 20 or 40 MBps.
- 1 Ultra2 SCSI: Uses an 8- or 16-bit bus and supports data rates of 40 or 80 MBps.
- 1 Ultra3 SCSI: Uses a 16-bit bus and supports data rates of 80 or 160 MBps.
- 1 Ultra160 SCSI: Uses a 16-bit bus and supports data rates of 160 MBps.

**software.** Programs, procedures, rules, and any associated documentation pertaining to the operation of a computer system.

**speed matching.** A technique used by the tape drive to dynamically adjust its native (uncompressed) data rate to the slower data rate of a server. Speed matching improves system performance and reduces backhitch.

**status light.** Located at the front of the tape drive, an LED that can be green or amber, and (when lit) solid or flashing. The condition of the light represents the state of the drive.

## T

**TapeAlert.** A patented technology and ANSI standard that defines conditions and problems that are experienced by tape drives.

**TapeAlert flags.** Status and error messages that are generated by the TapeAlert utility and display on the server's console.

**tape cartridge.** A removable storage case that houses belt-driven magnetic tape that is wound on a supply reel and a takeup reel.

**tape drive.** A data-storage device that controls the movement of the magnetic tape in a tape cartridge. The Dell PowerVault 110T LTO-3 tape drive houses the mechanism (drive head) that reads and writes data to the tape. Its native data capacity is 400 GB per cartridge; with 2:1 compression, its capacity is up to 800 GB.

**tape path.** Within a tape drive, the channel in which the media moves.

**terminate.** To prevent unwanted electrical signal reflections by applying a device (known as a terminator) that absorbs the energy from the transmission line.

**terminator.** (1) A part that is used to end a SCSI bus.

(2) A single-port, 75-ohm device that is used to absorb energy from a transmission line. Terminators prevent energy from reflecting back into a cable plant by absorbing the radio frequency signals. A terminator is usually shielded, which prevents unwanted signals from entering or valid signals from leaving the cable system.

**Test Head diagnostic.** A test that determines whether the heads of the tape drive are operating properly and whether the drive can correctly read from and write to tape.

**transfer rate.** See **data transfer rate**.

## U

**Ultra160 LVD SCSI interface.** See **Small Computer Systems Interface**.

**unload.** The act (performed by the drive) of unthreading tape from the drive's internal tape path and returning it (with the leader block) to the tape cartridge.

**utility.** See **utility program**.

**utility program.** A computer program that supports computer processes. For example, a diagnostic program, a trace program, or a sort program.

## V

**VDC.** Volts DC (direct current).

**volt.** The SI (international) unit of potential difference and electromotive force. Formally defined as the difference of electric potential between two points of a conductor that carries a constant current of one ampere when the power dissipated between these points is equal to one watt.

## W

**wet bulb temperature.** The temperature at which pure water must be evaporated adiabatically at constant pressure into a given sample of air in order to saturate the air under steady-state conditions. Wet bulb temperature is read from a wet bulb thermometer.

**write.** To make a permanent or transient recording of data in a storage device or on a data medium.

**write protected.** Applicable to a tape cartridge, the condition that exists when some logical or physical mechanism prevents a device from writing on the tape in that cartridge.

**write-protect switch.** Located on the tape cartridge, a switch that prevents accidental erasure of data. Pictures of a locked and unlocked padlock appear on the switch. When you slide the switch to the locked padlock, data cannot be written to the tape. When you slide the switch to the unlocked padlock, data can be written to the tape.

**Write/Read test.** Part of the Test Head diagnostic, a procedure that determines whether the tape drive can correctly read from and write to tape.

---

[Back to Contents Page](#)

[Back to Contents Page](#)

## Introduction: Dell™ PowerVault™ 110T LTO-3 Tape Drive User's Guide

- [Overview](#)
  - [SCSI Bus Interface](#)
  - [Features](#)
  - [Tape Backup Software](#)
  - [Front Panel](#)
  - [Rear Panel](#)
- 

### Overview

The Dell PowerVault 110T LTO-3 tape drive is a high-performance, high-capacity data-storage device that is designed to perform unattended backups, restore Open Systems applications, and retrieve and archive files. The drive can be integrated into a system (internal model) or can be provided as a separately packaged desktop unit (external model). The Dell PowerVault 110T LTO-3 tape drive (called Generation 3) is the third-generation tape drive in the LTO series of products.

The Dell PowerVault 110 LTO-3 tape drive offers a formatted cartridge capacity of up to 400 GB (800 GB assuming 2:1 compression ratio) and a data transfer rate of 80 MB per second (135 MB per second at maximum compression).

Figure 1 shows a front view of the internal model of the tape drive. Figure 2 shows a front view of the separately purchased external model of the tape drive.

**Figure 1. Front View (Internal Model)**

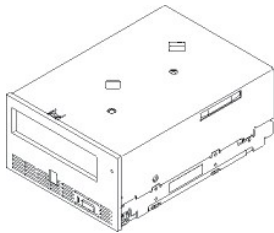

**Figure 2. Front View (External Model)**

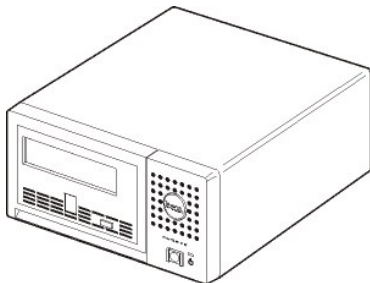

---

### SCSI Bus Interface

These tape drives are designed to operate on an Ultra160 low voltage differential (LVD) SCSI bus with a burst transfer rate of 160 MB per second. The interface is backward compatible with older SCSI technology.

The tape drive contains a high-density, 68-pin, D-Shell (HD-68) connector for attachment to the system. The drive supports LVD SCSI cables with HD-68 connectors.

---

### Features

The tape drive has the following features:

- 1 Capacity of 400 GB (native), 800 GB (compressed\*) on a single LTO tape
- 1 Built-in read-after-write verification for a high level of data integrity
- 1 Data transfer rate of 80 MB per second (native), 135 MB per second (compressed\*)
- 1 128 MB of read/write cache memory
- 1 Intelligent LTO-DC dual-mode compression algorithm
- 1 Failsafe leader capture mechanism with pin pick error recovery
- 1 LTO-Cartridge memory
- 1 TapeAlert support for worry-free backup
- 1 Ultra160 LVD SCSI interface
- 1 Speed matching (The tape drive can slow down to match the system data rate.)



- 1 Sleep mode for energy conservation
- 1 Backward read and write compatibility with Generation 2 cartridges
- 1 Backward read compatibility with Generation 1 cartridges
- 1 Compatible with all cartridges that bear the official Ultrium LTO logo
- 1 Will interchange tapes with other LTO tape drives that bear the official Ultrium LTO logo

\* Assumes maximum compression. The capacity and transfer rate you realize in practice depends on the data set, which affects the actual compression ratio.

## Tape Backup Software

You need backup software that supports the DELL PowerVault 110T LTO-3 tape drive. As a general rule, native backup applications (such as NTBackup and tar) do not provide the required data streaming rate to get the full performance of your tape drive. We recommend using a backup application, which provides better memory management as well as other useful features, such as TapeAlert. For the latest supported software versions, go to [support.dell.com](http://support.dell.com) or visit the support site of your backup software vendor.

## Front Panel

Figure 3. Front Panel

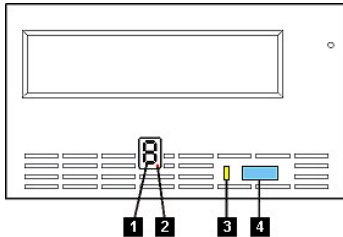

1. Single-character display
2. Single red dot
3. Status light
4. Eject button

**1. Single-character display.** This LED presents a single-character code for diagnostic/maintenance functions, error conditions, and informational messages.

**2. Single red dot.** This single-character display is blank during normal operation. When a single red dot illuminates on the display, the drive has created a dump of vital technical data to drive memory.

**3. Status Light.** The front panel of your Dell PowerVault 110T LTO-3 tape drive has a status light that provides information about the state of the tape drive. The light can be green or amber, and (when lit) solid or flashing. See Table 2 for descriptions.

Table 2. Status Light Descriptions

Color or Condition of Status Light	Meaning
Off	The tape drive has no power or is powered off.
Green/Solid	The tape drive is powered on and in an idle state.
Green/Flashing	One of the following applies: <ul style="list-style-type: none"> <li>1 If the light flashes less than once per second, the tape drive is in sleep mode.</li> <li>1 If the light flashes less than once per second, the tape drive contains a cartridge during the power-on cycle. In this case, the tape drive completes its Power-On Self-Test (POST) and slowly rewinds the tape (the process may take up to 10 minutes). The light stops flashing and becomes solid when the tape drive completes the recovery and is ready for a read or write operation. To eject the cartridge, press the eject button.</li> <li>1 If the light flashes once per second, the tape drive is reading from the tape, writing to the tape, rewinding the tape, or locating data on the tape.</li> </ul>
Amber/Solid	One of the following applies: <ul style="list-style-type: none"> <li>1 The tape drive is performing a selected operation.</li> <li>1 The tape drive is displaying the drive error code log.</li> <li>1 The tape drive is in maintenance mode or is exiting maintenance mode.</li> </ul>
Amber/Flashing	One of the following applies: <ul style="list-style-type: none"> <li>1 If the light flashes less than once per second, the tape drive is updating firmware through the field microcode replacement (FMR) tape, or the SCSI, Fibre Channel, or RS-422 interface, or the drive has exceeded the recommended temperature.</li> <li>1 If the light flashes less than once per second, the tape drive has detected an error and is performing a firmware recovery. It resets automatically.</li> <li>1 If the light flashes less than once per second, the tape drive is requesting a cartridge be loaded, or there is a drive dump in flash memory.</li> <li>1 If the light flashes once per second, an error occurred and the tape drive or media may require service. Note the code on the single-character display, then go to "<a href="#">Descriptions and Corrective Actions</a>" to determine the action that is required.</li> <li>1 If the light flashes once per second and a  displays in the character display, the tape drive needs to be cleaned.</li> </ul>

**4. Eject button.** The eject button enables you to perform several functions. These functions are described in detail in "[Using the Tape Drive.](#)"

---

## Rear Panel

Figure 4. Rear Panel of Internal Tape Drive

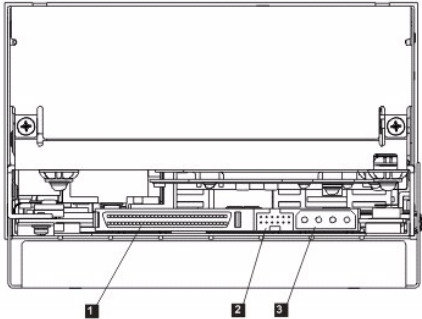

- 1. SCSI connector
- 2. SCSI ID connector
- 3. Power connector

Figure 5. Rear Panel of External Tape Drive

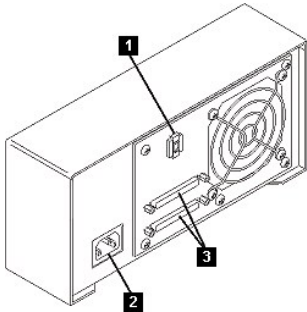

- 1. SCSI address switch
- 2. Power receptacle
- 3. External SCSI connectors

---

Please read all [restrictions and disclaimers](#).

---

[Back to Contents Page](#)

## Setting Up the Tape Drive: Dell™ PowerVault™ 110T LTO-3 Tape Drive User's Guide

- [Pre-installed Internal Drives](#)
  - [Installing Internal Drives](#)
  - [Installing External Drives](#)
  - [Loading Device Drivers](#)
  - [Verifying Drive Operation](#)
- 

### Pre-installed Internal Drives

Dell performs the installation and setup of internal tape drives that are shipped as part of a system. Tape backup software normally is installed by Dell. If the software has been recently upgraded, however, you may need to install the software. In this case, installation instructions are provided with the software.

For the latest supported software versions, go to [support.dell.com](http://support.dell.com) or visit the support site of your backup software vendor

---

### Installing Internal Drives

If your internal tape drive is not pre-installed, the installation instructions are as follows:

#### Installing the Drive — Prerequisites

Dell PowerVault 110T LTO-3 tape drives are Ultra160 LVD SCSI devices with a burst transfer rate of 160 MB per second. Do not use the drive on a single-ended SCSI bus, as performance is restricted. Do not use on the same bus as other single-ended devices, as this will switch the LVD host adapter into single-ended mode and restrict performance. We recommend that a dedicated host bus adapter is used for the tape drive.

The tape drives have a 68-pin wide, high-density SCSI connector. If you are using a tape drive on an internal bus with other peripherals that run at Ultra2 speeds, it is important that a 68-pin LVD-compatible ribbon cable is used.

#### Mounting Bay

You need one industry-standard, 5 1/4-inch, full-height bay in which to install the PowerVault 110T LTO-3 tape drive. The drive may be mounted vertically or horizontally.

Install and configure the drive according to the instructions provided in the Dell documentation for your system.

#### Mounting Hardware

Most systems use trays or rails to mount the tape drive. For some systems, no tray or rails are required. Devices simply slide into the system's chassis and are fixed with screws.

### Installing the Drive — Step-By-Step Instructions

#### Step 1 — Unpacking the Drive

Unpack the tape drive and store the packaging. You may need the packaging if you return the unit for service.

A period of time is required if the temperature of the drive when unpacked is different than the temperature of its operating environment (measured at the front of the bezel near the air intake area; see number 1 in [Figure 1](#)). The recommended time is 4 hours after the drive has been unpacked or 1 hour after any condensation that you can see has evaporated, whichever is greater. To allow the drive to adjust to its new environment, apply the following measures:

- 1 If the drive is colder than its operating environment and the air contains sufficient humidity, condensation may occur in the drive and damage it. When the drive has warmed to the operating temperature range (greater than 10 degrees C or 50 degrees F) and no danger of condensation is present (the air is dry), warm the drive more quickly by powering it on for 30 minutes. Use a scratch tape to test the drive before inserting a tape that contains data.
- 1 If the drive is hotter than its operating environment, the tape can stick to the drive head. When the drive has cooled to the operating temperature range (less than 40 degrees C or 104 degrees F), cool the drive more quickly by applying airflow for 30 minutes. Power on the drive and use a scratch tape to test it before inserting a tape that contains data.

If you are uncertain about whether the temperature of the drive is within the recommended operating range or the humidity is sufficient to cause condensation, allow the drive to adjust to its new environment for the full 4 hours.

**Figure 1. Air Intake Area**

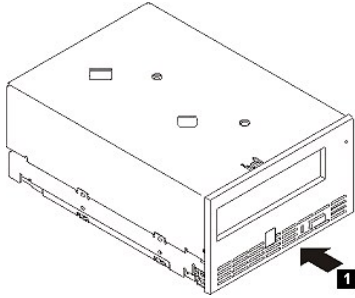

### Step 2 – Removing Power from the System

1. Power-off the system.
2. Disconnect the power cord from both the electrical outlet and the system.

### Step 3 – Setting the SCSI ID

Your tape drive is shipped with a default SCSI ID of 6, but it can be assigned any unused ID between 0 and 15. Do not use SCSI ID 7, which is reserved for the SCSI controller, or SCSI ID 0, which is typically assigned to the boot disk. We do not recommend installing the drive onto a narrow SCSI bus, as this will restrict performance.

**NOTICE:** Static electricity can damage electronic components. Always wear an antistatic wriststrap if possible. If not, to equalize the electromagnetic charges, touch a bare metal part of the computer (such as the back plate) before you remove the tape drive from its bag.

To set the SCSI ID:

1. Locate the SCSI ID connector (see number 2 in Figure 4 in the "[Introduction](#)"). The SCSI ID is set using jumpers on a set of pins at the rear of the drive.
2. Determine whether you need to change the SCSI ID from the default of 6. Make sure the ID is not used by another device.
3. Referring to Figure 2, find the ID number that you chose. Then, place jumpers on the connector pins as shown (use a pair of needle-nose pliers to connect the jumpers to the pins that are shaded). Spare jumpers will be on the pin array itself (but only attached to a single pin).

Figure 2. SCSI Connector Pins

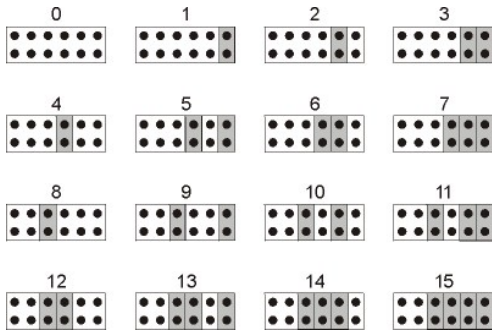

### Step 4 – Preparing the Mounting Bay in Your System

**CAUTION:** To avoid personal injury or damage to the system or tape drive, ensure that the system power cord is disconnected before you install the drive.

Refer to your system's documentation for instructions on how to prepare the mounting bay to receive the tape drive.

### Step 5 – Attaching Mounting Hardware

If your system requires special rails or other hardware to install the tape drive, mount them on the tape drive in this step.

If your system does not require special mounting hardware, proceed to step 6.

### Step 6 – Installing the Drive

Slide the tape drive into the open bay, aligning the tray or rails with the slots in the bay, as shown in Figure 3.

Figure 3. Install the Drive

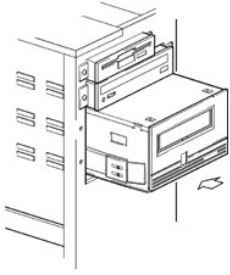

If your system does not use mounting hardware, check that the holes in the chassis are aligned with the holes in the side of the tape drive (see Figure 4).

**Figure 4. Mounting Holes on Tape Drive**

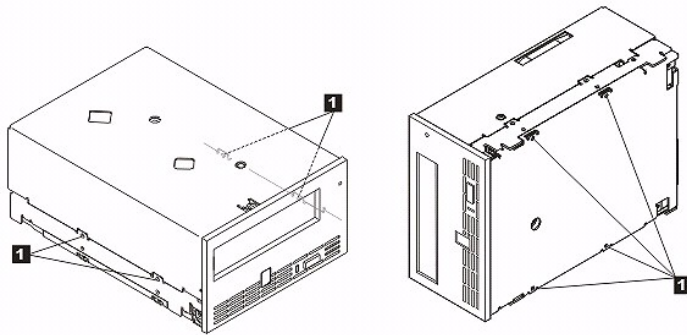

1. M-3 mounting screw holes

Do not secure the drive with screws at this point because you may have to move the drive to get the cables in place.

#### Step 7 – Attaching Power and SCSI Cables

Attach a spare power cable from the system's internal power supply to the power connector, as shown in [Figure 5](#), number 1.

Attach a spare SCSI cable on the system's SCSI ribbon cable to the SCSI connector, as shown on [Figure 5](#), number 2.

 **NOTE:** If the drive is the last device on the SCSI chain, it must be terminated.

**Figure 5. Attach Power and SCSI Cables**

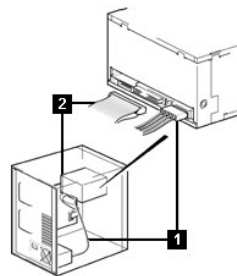

1. Power cable
2. SCSI cable

#### Step 8 – Securing the Drive

The tape drive can be mounted several ways. Ensure that you have the proper mounting rails or drive mounting sled and the correct screws (M-3). Some systems require the drive to be inserted into a media bay and attached directly to the system.

**Figure 6. Secure the Drive**

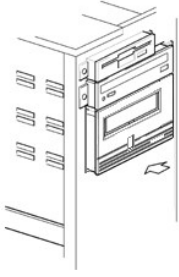

### Step 9 – Connecting Computer Power and Testing Power to the Tape Drive

Connect the power cord to the system and to the electrical outlet. To ensure that the drive is receiving power, watch for the following while turning on the power to the system:

1. The single-character display presents a series of random characters.
2. The single-character display becomes blank (not lit).
3. The status light briefly becomes solid amber, then becomes solid green.

## Installing External Drives

### Installing the Drive – Prerequisites

The tape drives are Ultra160 SCSI devices designed to operate on a low voltage differential (LVD) SCSI bus with a burst transfer rate of 160 MB per second. Do not use the drive on a single-ended SCSI bus, as performance is restricted. Do not use on the same bus as other single-ended devices, as this will switch the LVD's host adapter into single-ended mode and restrict performance. We recommend that a dedicated host bus adapter is used for the tape drive.

Your system must have a properly installed and configured SCSI host adapter or a SCSI controller on the motherboard (SCSI-2 or SCSI-3 compliant) with driver software that supports the tape drive. Check the system documentation for the specification of any built-in SCSI channels. Do not connect to a RAID controller channel; these are for disk drives only. Consult your supplier for details.

The tape drive will attach to a system with a HD-68 LVD SCSI connector (68 pins). If your system or host bus adapter is equipped with a very high density (VHD) wide SCSI connector, you will need to order a 68-pin HD-to-VHD converter or 68-pin HD-to-VHD cable.

### Installing the Drive – Step-By-Step Instructions

#### Step 1 – Setting the SCSI ID

Your tape drive is shipped with a default SCSI ID of 6, but it can be assigned any unused ID between 0 and 15. Do not use SCSI ID 7, which is reserved for the SCSI controller, or SCSI ID 0, which is typically assigned to the boot disk. We do not recommend installing the drive onto a narrow SCSI bus, as this will restrict performance.

Determine whether you need to change the SCSI ID from the default of 6.

Change the tape drive's SCSI ID, if necessary. Use a small screwdriver or a ball-point pen to press the indented SCSI ID selector buttons on the rear panel (see number 1 in [Figure 7](#)) until the required value is displayed. Do not use a pencil because small bits of lead could contaminate the drive. The computer and the tape drive SCSI IDs are only checked at power-on. To change the SCSI ID after installation, power down both the system and the tape drive, change the drive's SCSI ID, power up the tape drive, and then power up the system.

**Figure 7. Rear Panel of the External Tape Drive**

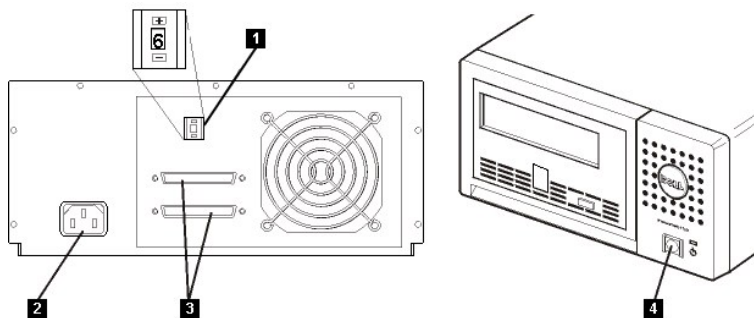

1. SCSI address switch
2. Power receptacle
3. External SCSI connectors
4. Power on/off button

#### Step 2 – Positioning the Tape Drive

Position the tape drive anywhere that is convenient to the system. The only restrictions are the length of the power cord and the length of the SCSI cable. Recommended locations are:

1. Away from high-traffic areas, especially if the floor is carpeted.

- 1 Out of copy rooms to avoid toner and paper dust. Do not store paper supplies next to any unit.
- 1 Away from moving air, such as doorways, open windows, fans, and air conditioners.
- 1 Off the floor.
- 1 In a horizontal position.
- 1 Where the tape cartridge can easily be inserted.

The tape drive should not be stacked. Do not place anything on top of the unit.

### Step 3 – Connecting Power

An external Dell PowerVault 110T LTO-3 Tape Drive will operate using any voltage in the range 100–240 volts (50–60 Hz). No adjustment is needed. To connect your drive to the power supply, proceed as follows:

1. Ensure that the power on/off button is set to off by pressing it (See number 4 in [Figure 7](#)).
2. Plug the power cable securely into the socket on the rear panel of the drive. (See number 2 in [Figure 7](#).)
3. Plug the other end of the power cable into a grounded power outlet.
4. Because the tape drive may not complete the Power-On Self-Test (POST) without SCSI termination, ensure that the terminator (or SCSI bus with termination) is connected to one of the two SCSI connectors at the rear of the unit (See number 3 in [Figure 7](#)).
5. Power on the tape drive by pressing the power on/off button (See number 4 in [Figure 7](#)). The tape drive runs the POST, which checks all hardware except the drive head.
6. Write the model name, product number, serial number, SCSI ID, and service tag number (external drives only) of your drive somewhere safe for future reference. The model name is on the front of the drive and the product service tag, and serial numbers are on a label on the bottom of the drive.

### Step 4 – Connecting the SCSI Cable

Perform a normal system shutdown and turn off the system and any connected peripherals. Ensure that the tape drive is plugged into an electrical outlet.

**NOTICE:** To avoid damaging the system or tape drive, ensure that both are powered off while you attach the SCSI cable. For optimum performance, we recommend that your tape drive is installed on a dedicated SCSI bus.

If the tape drive is the only device on the SCSI bus, attach one end of the SCSI cable to the system. Attach the other end of the SCSI cable to either SCSI connector on the rear panel of the tape drive (see number 3 in [Figure 7](#)) and secure it by tightening the screws. The cable can be up to 25 m (82 ft) long when the tape drive is the only device on the bus. This configuration is shown in [Figure 8](#).

**Figure 8. Connecting One SCSI Device**

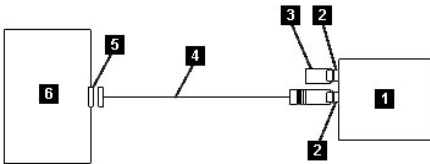

1. Tape drive
2. SCSI connectors
3. Terminator
4. SCSI bus cable
5. SCSI host adapter card
6. System

If the tape drive is one of multiple devices on the SCSI bus, connect the SCSI cable to the next device on the bus, move the terminator to the last device on the bus, and then issue the system command to resume operation. This configuration is shown in [Figure 9](#). The cable can be up to 12 m (39 ft) long.

**Figure 9. Connecting Multiple SCSI Devices**

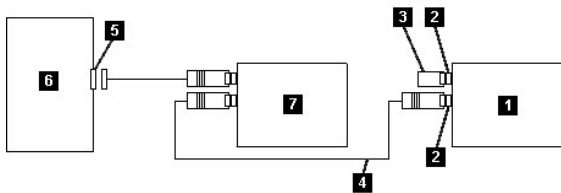

1. Tape drive
2. SCSI connectors
3. Terminator
4. SCSI bus cable
5. SCSI host adapter card
6. System
7. Another device

### Step 5 – Configuring the Tape Drive to the Host

Power on the tape drive. Refer to your system and application software manuals to configure the tape drive for use.

## Loading Device Drivers

### Microsoft® Windows® 2000

This section describes how to install, remove, and disable the Microsoft Windows 2000 Device Drivers for the tape drive.

## Installation Procedures

1. Make sure that you are logged on to the host server or workstation with Administrator privileges.
2. Insert the Dell PowerVault 110T LTO-3 Drive Support CD into the CD-ROM drive on the host server or workstation.
3. Right-click the **My Computer** icon on the Windows desktop, click **Manage**, and then click **Device Manager**.

The tape drive should be listed under the **? Other Devices** item as **IBM Ultrium-TD3 SCSI Sequential Device**.

4. Right-click the **IBM Ultrium-TD3 SCSI Sequential Device** listing, click **Uninstall**, and then click **OK** to confirm that you want to remove the device.
5. Click **Action** in the upper-left corner of the **Computer Management** dialog box.
6. Click **Scan for Hardware Changes**.

Windows 2000 scans for the Dell PowerVault 110T LTO-3 drive. The tape drive appears under **? Other Devices** again.

7. Right-click the **IBM Ultrium-TD3 SCSI Sequential Device** listing and click **Properties**.
8. Click **Reinstall Driver**.
9. When the Upgrade Device Driver Wizard appears, click **Next**.
10. Click **Display a list ...** and then click **Next**.
11. Click the **Tape Drives** item in the list. You may have to scroll down to see this item. Click **Next**.
12. Click **Have Disk**, type `d:\Drivers\Windows 2000, 2003 32bit x86`, replacing `d:` with the drive letter for the CD-ROM drive into which you inserted the support CD, and click **OK**.
13. Click the **IBM Ultrium LTO Generation 3 tape drive** entry and click **Next**.
14. Click **Next** to install the driver.
15. You may get a warning that says *Installing this driver is not recommended ...* Click **Yes** anyway.
16. Click the **Finish** button.
17. Close the **Device Properties** dialog box.
18. The drive now appears in **Device Manager** under **Tape Drives** and is ready to use.

## Microsoft Windows 2003

This section describes how to install, remove, and disable the Microsoft Windows 2003 Device Drivers for the tape drive.

### Installation Procedures

1. Make sure that you are logged on to the host server or workstation with Administrator privileges.
2. Insert the Dell PowerVault 110T LTO-3 Drive Support CD into the CD drive on the host server or workstation.
3. Right-click the **My Computer** icon on the Windows desktop, click **Manage**, and then click **Device Manager**.

The tape drive should be listed under the **? Other Devices** item as **IBM Ultrium-TD3 SCSI Sequential Device**.

4. Right-click the **IBM Ultrium-TD3 SCSI Sequential Device** listing, click **Uninstall**, and then click **OK** to confirm that you want to remove the device.
5. Right-click the topmost item in the menu structure in the right half of the **Computer Management** window.

A pop-up window displays.

6. Click **Scan for Hardware Changes**.

Windows 2003 scans for the Dell PowerVault 110T LTO-3 drive. (If a wizard pops up at this point, cancel the wizard. It will be used later.) The tape drive appears under **? Other Devices** again. If the tape drive is not visible, you may have to click the plus sign ("+") in front of **? Other Devices** to make it appear.

7. Right-click the **IBM Ultrium-TD3 SCSI Sequential Device** listing and click **Properties**.
8. Click the **Reinstall Driver** button. (If the **Reinstall Driver** button is not visible, you may have to click the **Driver** tab, then **Update driver**.)
9. The Upgrade Device Driver Wizard appears.
10. Click the **Install from List or Specific Location** radio button.
11. Click the **Next** button.
12. Click **Include this location in the search**.
13. Type the driver name in the directory field, replacing `d:` with the drive letter for the CD drive into which you inserted the support CD and click the **Next** button. Driver names are as follows:
  - o Windows 2003 32 bit: `d:\Drivers\Windows 2000, 2003 32bit x86\dtapeW32.inf`
  - o Windows 2003 64 bit: `d:\Drivers\Windows 2003 IA64\dtapeW64.inf`
  - o Windows 2003 x64: `d:\Drivers\Windows 2003 x64\dtapex64.inf`
14. You may have to click **Continue** to bypass a warning.
15. Click **Finish**.
16. Close the **Device Properties** dialog box.
17. The drive now appears in **Device Manager** under **Tape Drives** and is ready to use.

---

## Verifying Drive Operation

Once you have installed the drive hardware, you should verify that it is functioning properly before you store your valuable data. Turn on the system. For external drives, turn on the drive before you turn on the system.

The tape drive will run its POST which checks all hardware except for the drive head. The single-character display will present a series of random characters, then become blank (not lit). The status light will briefly become solid amber, then become solid green.

Verify that the tape drive installation was successful. Following the instructions given with your Tape Backup Software application, write test data to a tape, read the test data from the tape and compare the data read from the tape with the original data on disk.

---

Please read all [restrictions and disclaimers](#).

---

[Back to Contents Page](#)



[Back to Contents Page](#)

## Using the Tape Backup Software: Dell™ PowerVault™ 110T LTO-3 Tape Drive User's Guide

---

See the User's Operating Guide supplied with your Tape Backup application. For the latest supported software versions, go to [support.dell.com](http://support.dell.com) or visit the support site of your backup software vendor

---

Please read all [restrictions and disclaimers](#).

---

[Back to Contents Page](#)

## Specifications: Dell™ PowerVault™ 110T LTO-3 Tape Drive User's Guide

- [General](#)
- [External Drive](#)
- [Internal Drive](#)



NOTE: These specifications are provided by the manufacturer for information purposes only and do not constitute an extension of Dell's warranty to you. Dell's warranty is contained in the documentation for your system.

### General

Manufacturer	Manufactured for Dell
Model Number	DELL PowerVault 110T LTO-3 Tape Drive: LTO Internal; LTO External
Interface Type	Ultra160 Low Voltage Differential (LVD) SCSI bus

### External Drive

#### Physical Specifications

Width	24.9 cm (9.8 in)
Length	29.0 cm (11.42 in)
Height	12.5 cm (4.92 in)
Weight	6.45 kg (14.2 lb)

#### Power Requirements

AC line voltage	100–240 VAC
Line frequency	50–60 Hz, auto-ranging
Line current at 100 VAC	0.58 A
Line current at 240 VAC	0.24 A

#### Performance

Interface	Ultra160 LVD SCSI
Recording format	LTO Ultrium Generation 3
Media	LTO Ultrium
Capacity	400 GB (native) 800 GB (compressed, assuming 2:1 compression)
Data transfer rate	Native 80 MB/sec, at maximum compression 135 MB/sec
Burst transfer rate	up to 160 MB/sec

#### Operating Limits

Temperature	10° to 35°C (50° to 95°F)
Humidity	20% to 80% relative humidity (noncondensing)
Maximum wet bulb temperature	23°C (73.4°F)
Maximum altitude	3048 m (10,000 ft)

#### Nonoperating Limits (Storage or Shipping)

Temperature	-40° to 65°C (-40° to 149°F)
Humidity	5% to 95% relative humidity (noncondensing)
Maximum wet bulb temperature	23°C (73.4°F)

## Internal Drive

### Physical Specifications

Width (without bezel)	146.0 mm (5.75 in)
Width (with bezel)	148.3 mm (5.84 in)
Length (without bezel)	205.5 mm (8.09 in)
Length (with bezel)	210.5 mm (8.29 in)
Height (without bezel)	82.5 mm (3.25 in) without bezel
Height (with bezel)	84.8 mm (3.34 in) with bezel
Weight (without a cartridge)	3 kg (6 lb 10 oz)

### Power Supply

Tolerance	+ 5 VDC and + 12 VDC (plus or minus 10%)
Current for 5 VDC	1.3 A minimum/3.0 A maximum
Current for 12 VDC	0.2 A minimum/1.1 A maximum
Peak supply current* for 5 VDC	3.3 A for 100 ms/15.5 W
Peak supply current* for 12 VDC	4.5 A for 2 ms/49.2 W

\*instantaneous power by the power supply

### Power Usage

Idle mode with no cartridge	10 W
Idle mode with a cartridge loaded	12 W
Reading and writing at 6.22 m/s	28 W

### Performance

Interface	Ultra160 LVD SCSI
Recording format	LTO Ultrium Generation 3
Media	LTO Ultrium
Capacity	400 GB (native) 800 GB (compressed, assuming 2:1 compression)
Data transfer rate	native 80 MB/sec, at maximum compression 135 MB/sec
Burst transfer rate	up to 160 MB/sec

### Operating Limits

Temperature	10° to 35°C (50° to 95°F)
Humidity	20% to 80% relative humidity (noncondensing)
Maximum wet bulb temperature	23°C (73.4°F)
Maximum altitude	3048 m (10,000 ft)

### Nonoperating Limits (Storage)

Temperature	-40° to 65° (-40° to 149°F)
Humidity	5% to 95% relative humidity (noncondensing)
Maximum wet bulb temperature	23°C (73.4°F)

---

Please read all [restrictions and disclaimers](#).

---

[Back to Contents Page](#)

## Troubleshooting: Dell™ PowerVault™ 110T LTO-3 Tape Drive User's Guide

- [Obtaining Drivers and Firmware Upgrades](#)
- [Selecting a Diagnostic or Maintenance Function](#)
- [General Guidelines](#)
- [Methods of Receiving Errors and Messages](#)
- [Descriptions and Corrective Actions](#)
- [Resolving Problems Reported by the System](#)
- [Resolving Media-Related Problems](#)
- [Removing a Tape Drive](#)
- [TapeAlert](#)
- [Manually Removing a Tape Cartridge](#)

### Obtaining Drivers and Firmware Upgrades



NOTICE: When updating firmware, do not power off the tape drive until the update is complete, or the firmware may be lost.

Periodically check for updated levels of firmware by visiting the Web at [support.dell.com](http://support.dell.com).









### Selecting a Diagnostic or Maintenance Function

The tape drive can run diagnostics, test write and read functions, test a suspect tape cartridge, and perform other diagnostic and maintenance functions. The drive must be in maintenance mode to perform these functions. To place the drive in maintenance mode and select a diagnostic or maintenance function, see [Table 1](#).



NOTE: Maintenance functions cannot be performed concurrently with read or write operations. While in maintenance mode, the tape drive does not accept SCSI commands from the system. Close all tape drive applications before entering maintenance mode.

Table 1. Diagnostic and Maintenance Function Codes and Descriptions

<b>Function Code 1 — Run SCSI Tape Drive Diagnostics</b>
Causes the tape drive to run self tests.
<b>Attention:</b> Insert only a scratch data cartridge for this test. Data on the cartridge will be overwritten.
<ol style="list-style-type: none"><li>1. Make sure that no cartridge is in the drive.</li><li>2. Within a 2-second interval, press the eject button three times. The status light becomes solid amber, which means that the drive is in maintenance mode.</li><li>3. Press the eject button once per second until  appears in the single-character display. If you cycle past , continue to press the eject button until it redisplay.</li><li>4. To select the function, press and hold the eject button for 3 seconds. After you select the function,  flashes, the drive runs diagnostics for approximately 90 seconds, then  flashes. When  flashes, the drive is waiting for a cartridge.</li><li>5. Within 60 seconds, insert a scratch data cartridge that is not write-protected (or the tape drive exits maintenance mode). After you insert the cartridge,  flashes and the test begins.<ul style="list-style-type: none"><li>o If the diagnostic completes successfully, it begins again and runs for a maximum of ten times. Each loop takes approximately 20 minutes to run. After the tenth loop, the diagnostic stops and automatically exits maintenance mode.</li><li>o If the diagnostic fails, the status light flashes amber and an error code displays. The tape drive unloads the tape cartridge and exits maintenance mode.</li><li>o To halt the diagnostic at the end of the current 20-minute test loop, press the eject button once. The drive acknowledges the request by slowing the length of time that the currently displayed character flashes on the single-character display (from twice per second to once per second.) The diagnostic continues to the end of its loop and then stops. The tape drive then displays "0", rewinds and unloads the cartridge, and exits maintenance mode.</li><li>o To halt the diagnostic immediately and terminate the test that is running, press the eject button twice. The tape drive displays "0", rewinds and unloads the cartridge, and exits maintenance mode.</li></ul></li></ol>
<b>Function Code 2 — RESERVED (Service Function)</b>
<b>Function Code 3 — RESERVED (Service Function)</b>
<b>Function Code 4 — Force a Dump of Vital Data to Tape Drive Memory</b>
Causes the tape drive to perform a collection (or <i>dump</i> ) of vital technical data to drive memory. (A drive dump is also known as a save of the firmware trace.)
 <b>NOTICE:</b> When an error code displays, a red dot also displays to remind you that a dump already exists. If you perform Function Code 4, it will overwrite the dump and cause the error information to be lost.
<ol style="list-style-type: none"><li>1. Make sure that no cartridge is in the drive.</li><li>2. Within a 2-second interval, press the eject button three times. The status light becomes solid amber, which means that the drive is in maintenance mode.</li><li>3. Press the eject button once per second until  appears in the single-character display. If you cycle past , continue to press the eject button until it redisplay.</li></ol>

4. To select the function, press and hold the eject button for 3 seconds. After you select the function, **4** displays, followed by **0**. The single-character display then goes blank, and the tape drive exits maintenance mode.

An illuminated red dot on the single-character display indicates that a drive dump has been created.

You can also perform this operation when the tape drive is in normal operating mode. Simply press and hold the eject button for 10 seconds.

#### Function Code 5 — RESERVED (Service Function)

#### Function Code 6 — RESERVED (Service Function)

#### Function Code 7 — RESERVED (Service Function)

#### Function Code 8 — RESERVED (Service Function)

#### Function Code 9 — Display Error Code Log

Causes the tape drive to display the last ten error codes, one at a time (the codes are ordered; the most recent is presented first and the oldest (tenth) is presented last).

To view the drive error log:

1. Make sure that no cartridge is in the drive.
2. Within a 2-second interval press the eject button three times. The status light becomes solid amber, which means that the drive is in maintenance mode.
3. Press the eject button once per second until **9** appears in the single-character display.
4. Press and hold the eject button for 3 seconds to view the most recent error code.
5. Refer to "[Descriptions and Corrective Actions](#)" to determine the meaning of the code and the action to take.
6. Press the eject button to view the next error code. (The codes are ordered; the most recent is presented first and the oldest (tenth) is presented last.)
7. Continue to press the eject button until **0** appears, indicating that no more error codes exist. If no errors have been encountered or the log has just been cleared, a **0** will appear immediately and the drive will exit maintenance mode. A maximum of ten error codes are stored.

To redisplay the error codes, repeat steps 1 through 7.

#### Function Code A — Clear Error Code Log

Causes the tape drive to erase the contents of the error code log.

1. Make sure that no cartridge is in the drive.
2. Within a 2-second interval, press the eject button three times. The status light becomes solid amber, which means that the drive is in maintenance mode.
3. Press the eject button once per second until **A** appears in the single-character display. If you cycle past **A**, continue to press the eject button until it redisplay.
4. To select the function, press and hold the eject button for 3 seconds. After you select the function, the tape drive erases all errors from the error code log, displays **0**, then exits maintenance mode.

#### Function Code C — Insert Cartridge Into Tape Drive

This function cannot be selected by itself. It relates to other maintenance functions (such as Run Tape Drive Diagnostics) that require a scratch tape cartridge that is not write protected.

#### Function Code E — Test Cartridge & Media

Causes the tape drive to perform a Write/Read test (on the edge bands) to ensure that a suspect cartridge and its magnetic tape are acceptable. The tape drive takes approximately 15 minutes to run one loop of the test. The test loops ten times before completing.

1. If no error is detected, the test begins again and runs for a maximum of ten times. After the tenth loop, the test stops and the drive automatically exits maintenance mode.
1. If an error is detected, the tape drive displays "6" or "7", unloads the tape cartridge, and exits maintenance mode.
1. To halt the diagnostic at the end of the current 15-minute test loop, press the eject button once. The drive acknowledges the request by slowing the length of time that the currently displayed character flashes on the single-character display (from twice per second to once per second.) The diagnostic continues to the end of its loop and then stops. The tape drive then displays "0", rewinds and unloads the cartridge, and exits maintenance mode.
1. To halt the diagnostic immediately and terminate the test that is running, press the eject button twice. The tape drive displays "0", rewinds and unloads the cartridge, and exits maintenance mode.

**Attention:** Data on the suspect tape will be overwritten.

1. Make sure that no cartridge is in the drive.
2. Within a 2-second interval, press the eject button three times. The status light becomes solid amber, which means that the drive is in maintenance mode.
3. Press the eject button once per second until **E** appears in the single-character display. If you cycle past **E**, continue to press the eject button until it redisplay.
4. To select the function, press and hold the eject button for 3 seconds. After you select the function, **E** flashes. When **E** flashes, the drive is waiting for a cartridge. Within 60 seconds, insert the suspect data cartridge (or the tape drive exits maintenance mode). After you insert the cartridge, **E** flashes and the test begins:
  - o If no error is detected, the test begins again and runs for a maximum of ten times. After the tenth loop, the test stops and the drive automatically exits maintenance mode. To halt the test, press the eject button. The tape drive then rewinds and unloads the cartridge, displays **0**, and exits maintenance mode.
  - o If an error is detected, the tape drive displays **6** or **7**, unloads the tape cartridge, and exits maintenance mode.

#### Function Code F — Fast Read/Write Test

Causes the tape drive to perform tests to ensure that the drive can read from and write to tape. This diagnostic performs fewer tests than the Run Tape Drive Diagnostics test (Function Code 1). The tape drive takes approximately 3 minutes to run the test. The Fast Read/Write Test is not as comprehensive a test and is not recommended for isolating errors between the drive and the media.

**Attention:** Data on the suspect tape will be overwritten.

1. Make sure that no cartridge is in the drive.
2. Within a 2-second interval, press the eject button three times. The status light becomes solid amber, which means that the drive is in maintenance mode.
3. Press the eject button once per second until **F** appears in the single-character display. If you cycle past **F**, continue to press the eject button until it redispays.
4. To select the function, press and hold the eject button for 3 seconds. After you select the function, **C** flashes. When **C** flashes, the drive is waiting for a cartridge. Within 60 seconds, insert the suspect data cartridge (or the tape drive exits maintenance mode). After you insert the cartridge, **F** flashes and the test begins.
  - o If no error is detected, the test begins again and runs for a maximum of ten times. Each loop takes approximately 3 minutes to run. After the tenth loop, the test stops and the drive automatically exits maintenance mode.
  - o If an error is detected, the tape drive displays an error code, unloads the tape cartridge, and exits maintenance mode.
  - o To halt the diagnostic at the end of the current 3-minute test loop, press the eject button once. The drive acknowledges the request by slowing the length of time that the currently displayed character flashes on the single-character display (from twice per second to once per second.) The diagnostic continues to the end of its loop and then stops. The tape drive then displays "0", rewinds and unloads the cartridge, and exits maintenance mode.
  - o To halt the diagnostic immediately and terminate the test that is running, press the eject button twice. The tape drive displays "0", rewinds and unloads the cartridge, and exits maintenance mode.

**Function Code H — Test Head**

Causes the tape drive to perform the Head Resistance Measurements test and a Write/Read test (on the center of the tape). The drive runs these tests to ensure that the tape drive's head and tape-carriage mechanics are working correctly. The tape drive takes approximately 10 minutes to run the test.

1. Make sure that no cartridge is in the drive.
2. Within a 2-second interval, press the eject button three times. The status light becomes solid amber, which means that the drive is in maintenance mode.
3. Press the eject button once per second until **H** appears in the single-character display. If you cycle past **H**, continue to press the eject button until it redispays.
4. To select the function, press and hold the eject button for 3 seconds. After you select the function, **C** flashes. When **C** flashes, the drive is waiting for a cartridge. Within 60 seconds, insert a scratch data cartridge (or the tape drive exits maintenance mode). After you insert the cartridge, **H** flashes and the test begins:
  - o If no error is detected, the test begins again and runs for a maximum of ten times. Each loop takes approximately 10 minutes to run. After the tenth loop, the test stops and the drive automatically exits maintenance mode.
  - o If an error is detected, the tape drive displays "5", unloads the tape cartridge, and exits maintenance mode.
  - o To halt the diagnostic at the end of the current 10-minute test loop, press the eject button once. The drive acknowledges the request by slowing the length of time that the currently displayed character flashes on the single-character display (from twice per second to once per second.) The diagnostic continues to the end of its loop and then stops. The tape drive then displays "0", rewinds and unloads the cartridge, and exits maintenance mode.
  - o To halt the diagnostic immediately and terminate the test that is running, press the eject button twice. The tape drive displays "0", rewinds and unloads the cartridge, and exits maintenance mode.

**Function Code L — Reserved for Future Use**

Reserved for future use.

**Function Code P or U — RESERVED (Service Function)**

**General Guidelines**

If you encounter problems when running the Dell PowerVault 110T LTO-3 Tape Drive, refer to Table 2 for common problems. If the problem is not identified, refer to "[Methods of Receiving Errors and Messages](#)." The color and condition of the status light may also indicate a problem.

**Table 2. General Troubleshooting**

If the problem is this....	Do this....
A code displays on the single-character display and the status light flashes amber.	The tape drive detected an error or is directing you to an informational message. See " <a href="#">Methods of Receiving Errors and Messages</a> ."
The status light or single-character display never turns on.	The tape drive has no power. Check the power at the power source. Connect power to the tape drive. If the problem persists, contact Dell technical support.
The tape drive will not load a tape cartridge.	One of the following has occurred: <ul style="list-style-type: none"> <li>1 A tape cartridge is already loaded. To remove the cartridge, press the eject button. If the cartridge does not eject, turn off the power to the tape drive, then turn it back on. After the status light becomes solid green, press the eject button to eject the cartridge.</li> <li>1 The tape cartridge was loaded incorrectly. To properly load a cartridge, see the Loading section in "<a href="#">Using the Tape Drive</a>."</li> <li>1 The tape cartridge may be defective. Load another tape cartridge. If the problem exists for multiple cartridges, the tape drive is defective. Contact Dell technical support.</li> <li>1 The tape drive has no power. Connect power to the tape drive.</li> </ul>
The tape drive will not unload the tape cartridge.	The tape cartridge is stuck or is broken. Press the eject button. If the cartridge does not eject, turn off the power to the tape drive, then turn it back on (note that the mid-tape recovery could take up to 10 minutes to complete). If the cartridge still does not eject, manually remove it (see " <a href="#">Manually Removing a Tape Cartridge</a> ").
The system received TapeAlert flags.	See " <a href="#">TapeAlert Flags</a> ."
The system reported SCSI problems (such as selection or command time-outs, or parity errors).	See " <a href="#">Resolving Problems Reported by the System</a> ."
Codes display on the single-character	

display, but the status light does not turn on.	The tape drive is defective. Contact Dell technical support.
The tape drive does not respond to system commands.	Press and hold the eject button on the drive for 10 seconds to force a drive dump. The drive will save the dump and then reboot to allow communication to the drive to occur. Do not cycle power, as this will erase the contents of the dump.

## Methods of Receiving Errors and Messages

Use [Table 3](#) as a guide for identifying error codes and message codes reported by the tape drive, its computer (if applicable), or the system.



 NOTE: The codes on the single-character display have different meanings, depending on whether they display during normal operations or while the drive is in maintenance mode. Codes that occur during normal operations are defined in "[Descriptions and Corrective Actions](#)." Codes that occur while in maintenance mode are defined in "[Selecting a Diagnostic or Maintenance Function](#)."

**Table 3. Methods of Receiving Errors and Messages**





If the error or message was presented by...	Do this....
The system's display (if the tape drive is enclosed in a library or autoloader)	Refer to the documentation for the system.
The tape drive's single-character display and the status light flashes amber	See " <a href="#">Descriptions and Corrective Actions</a> ." To determine the meaning of status light activity, see the Front Panel section in the " <a href="#">Introduction</a> ."
The tape drive's single-character display and the status light is solid amber	See " <a href="#">Selecting a Diagnostic or Maintenance Function</a> ." To determine the meaning of status light activity, see the Front Panel section in the " <a href="#">Introduction</a> ."
SCSI log sense data (such as TapeAlert flags) or SCSI drive sense data	See " <a href="#">TapeAlert Flags</a> " or " <a href="#">Descriptions and Corrective Actions</a> ."
The tape drive's error log	See " <a href="#">Descriptions and Corrective Actions</a> ."

## Descriptions and Corrective Actions

[Table 4](#) gives descriptions of the errors and messages that pertain to the tape drive, and tells what to do when you receive them.

 NOTICE: If the tape drive detects a permanent error and displays an error code other than  , it automatically performs a dump of vital data to drive memory. If you force a dump, the existing dump will be overwritten and data will be lost. After you force a dump, do not turn off the power to the tape drive or you may lose the dump data.

**Table 4. Descriptions and Corrective Actions**

Code	Cause and Action
	The single-character display clears if you power-off the drive.
	No error occurred and no action is required. This code displays: <ul style="list-style-type: none"> <li>1 When power is cycled (turned off, then on) to the tape drive.</li> <li>1 When diagnostics have finished running and no error occurred.</li> </ul> <p>NOTE: The single-character display is blank during normal operation of the tape drive.</p>
	Cooling problem. The tape drive detected that the recommended operating temperature was exceeded. Perform the following action: <ol style="list-style-type: none"> <li>1. If a fan is present in the system, ensure that it is rotating and is quiet. If not, replace the fan (for instructions about replacing the fan, see your system's documentation).</li> <li>2. Remove any blockage that prevents air from flowing freely through the tape drive.</li> <li>3. Ensure that the operating temperature and airflow is within the specified range (see "<a href="#">Specifications</a>").</li> <li>4. If the operating temperature is within the specified range and the problem persists, contact Dell technical support.</li> </ol> <p>The error code clears when you power-off the tape drive or place it in maintenance mode.</p>
	Power problem. The tape drive detected that the externally supplied power is either approaching the specified voltage limits (the drive is still operating) or is outside the specified voltage limits (the drive is not operating). Perform the following action: <ol style="list-style-type: none"> <li>1. Ensure that the power connector is properly seated.</li> <li>2. Ensure that the proper DC voltages are being applied within the tolerances allowed (see "<a href="#">Specifications</a>").</li> <li>3. If the proper voltages are being applied but the problem persists, contact Dell technical support.</li> </ol> <p>The error code clears when you power-off the tape drive or place it in maintenance mode.</p>
	Firmware problem. The tape drive determined that a firmware error occurred. Perform the following action: <ol style="list-style-type: none"> <li>1. Power the tape drive off and on, then retry the operation that produced the error. The error code clears when you power-off the tape drive or place it in maintenance mode.</li> <li>2. If the problem persists, download the latest firmware and retry the operation.</li> </ol>
	Firmware or tape drive problem. The tape drive determined that a firmware or tape drive hardware failure occurred. Perform the following action: <ol style="list-style-type: none"> <li>1. Power the tape drive off and on, then retry the operation that produced the error. The error code clears when you power-off the tape drive or place it in maintenance mode.</li> <li>2. If the problem persists, download the latest firmware and retry the operation; if new firmware is not available, contact Dell technical support.</li> </ol>

5	Tape drive hardware problem. The drive determined that a tape path or read/write error occurred. To prevent damage to the drive or tape, the drive will not allow you to insert a cartridge if the current cartridge was successfully ejected. The error code may clear when you cycle power to the tape drive or place it in maintenance mode. If the problem persists, contact Dell technical support.
6	<p>Tape drive or media error. The drive determined that an error occurred, but it cannot isolate the error to faulty hardware or to the tape cartridge. Perform the following action:</p> <p><b>For Problems With Writing Data:</b></p> <p>If the problem occurred while the drive was writing data to the tape, and if you know the volume serial number (located on the cartridge label) of the tape cartridge loaded in the drive when the problem occurred, retry the operation with a different cartridge:</p> <ul style="list-style-type: none"> <li>1 If the operation succeeds, the original cartridge was defective. Copy data from the defective cartridge and discard it.</li> <li>1 If the operation fails and another drive is available, insert the cartridge into the other drive and retry the operation. <ul style="list-style-type: none"> <li>o If the operation fails, discard the defective cartridge.</li> <li>o If the operation succeeds, insert a scratch cartridge into the first drive and run the tape drive diagnostics (see Function Code 1 in "<a href="#">Selecting a Diagnostic or Maintenance Function</a>"). <ul style="list-style-type: none"> <li>n If the diagnostics fail, contact Dell technical support.</li> <li>n If the diagnostics succeed, the error was temporary.</li> </ul> </li> </ul> </li> <li>1 If the operation fails and another drive is not available, insert a scratch cartridge into the drive and run the tape drive diagnostics (see Function Code 1 in "<a href="#">Selecting a Diagnostic or Maintenance Function</a>"). <ul style="list-style-type: none"> <li>o If the diagnostics fail, contact Dell technical support.</li> <li>o If the diagnostics succeed, discard the cartridge.</li> </ul> </li> </ul> <p>If the problem occurs with multiple tape cartridges or if you do not know the tape cartridge's volume serial number, run the tape drive diagnostics (see Function Code 1 in "<a href="#">Selecting a Diagnostic or Maintenance Function</a>):</p> <ul style="list-style-type: none"> <li>1 If the diagnostics fail, contact Dell technical support.</li> <li>1 If the diagnostics succeed, run the Test Head diagnostic (see Function Code H in "<a href="#">Selecting a Diagnostic or Maintenance Function</a>"). <ul style="list-style-type: none"> <li>o If the Test Head diagnostic fails, contact Dell technical support.</li> <li>o If the Test Head diagnostic succeeds, replace the cartridges that caused the problem.</li> </ul> </li> </ul>
6	<p>The error code clears when you remove the tape cartridge or place the drive in maintenance mode.</p> <p><b>For Problems With Reading Data:</b></p> <p>If the problem occurred while the drive was reading data from the tape, and if you know the volume serial number of the tape cartridge, perform one of the following procedures:</p> <ul style="list-style-type: none"> <li>1 If another drive is available, insert the cartridge into the other drive and retry the operation: <ul style="list-style-type: none"> <li>o If the operation fails, discard the defective cartridge.</li> <li>o If the operation succeeds, insert a scratch cartridge into the first drive and run the tape drive diagnostics (see Function Code 1 in "<a href="#">Selecting a Diagnostic or Maintenance Function</a>):</li> <ul style="list-style-type: none"> <li>n If the diagnostics fail, contact Dell technical support.</li> <li>n If the diagnostics succeed, the error was temporary.</li> </ul> </ul></li> <li>1 If another drive is not available, insert a scratch cartridge into the drive and run the tape drive diagnostics (see Function Code 1 in "<a href="#">Selecting a Diagnostic or Maintenance Function</a>):</li> <ul style="list-style-type: none"> <li>o If the diagnostics fail, contact Dell technical support.</li> <li>o If the diagnostics succeed, discard the cartridge.</li> </ul> </ul> <p>If the problem occurs with multiple tape cartridges or if you do not know the tape cartridge's volume serial number, run the tape drive diagnostics (see Function Code 1 in "<a href="#">Selecting a Diagnostic or Maintenance Function</a>):</p> <ul style="list-style-type: none"> <li>1 If the diagnostics fail, contact Dell technical support.</li> <li>1 If the diagnostics succeed, run the Test Head diagnostic (see Function Code H in "<a href="#">Selecting a Diagnostic or Maintenance Function</a>"). <ul style="list-style-type: none"> <li>o If the Test Head diagnostic fails, contact Dell technical support.</li> <li>o If the Test Head diagnostic succeeds, replace the cartridges that caused the problem.</li> </ul> </li> </ul> <p>The error code clears when you remove the tape cartridge or place the drive in maintenance mode.</p>
7	<p>A high probability of media error. The tape drive determined that an error occurred because of a faulty tape cartridge. Try another tape cartridge. If the problem occurs with multiple tape cartridges, see "<a href="#">Resolving Media-Related Problems</a>."</p> <p>The error code clears when you remove the tape cartridge or place the drive in maintenance mode.</p>
8	Tape drive or SCSI bus failure. The tape drive determined that a failure occurred in the tape drive's hardware or in the SCSI bus. See " <a href="#">Resolving Problems Reported by the System</a> ." The error code clears 10 seconds after the drive detected the error or when you place the drive in maintenance mode.
9	<p>Library to drive interface (RS-422) error. This interface is not used.</p> <p>The error code clears when you place the drive in maintenance mode.</p>
A	<p>Tape drive hardware problem. The tape drive determined that a problem occurred that degraded the operation of the tape drive, but it did not restrict continued use. If the problem persists, contact Dell technical support. The drive is usable, though the single-character display continues to indicate an error and the status light flashes amber.</p> <p>The error code may clear when you cycle power to the tape drive or place it in maintenance mode.</p>
b	No error or message is assigned.
c	<p>The tape drive needs to be cleaned. Clean the tape drive. See the Cleaning the Tape Mechanism section in "<a href="#">Using the Tape Drive</a>."</p> <p>The error code clears when you clean the tape drive or place it in maintenance mode.</p>
d	No error or message is assigned.
e	The eject button is depressed. Verify that the button pushes freely.



## Resolving Problems Reported by the System

The procedure for fixing SCSI bus errors varies, depending on whether the error is consistent or intermittent, and whether your configuration contains single or multiple tape drives. The sections that follow describe how to fix each type of error.

### Fixing a Consistent Error With a Single Drive on a SCSI Bus

1. Ensure that the power is on to the tape drive.
2. Ensure that the tape drive's SCSI address is the same as the SCSI address assigned by the system.
3. Replace the SCSI terminator and retry the failing operation.
4. Replace the SCSI cable and interposers, if any, and retry the failing operation.
5. If these measures do not correct the problem, contact Dell customer support.

### Fixing a Consistent Error With Multiple Drives on a SCSI Bus

When a consistent error occurs in a configuration that has multiple tape drives on the SCSI bus, you must determine if the problem exists with more than one tape drive. If the problem is with all of the devices on the SCSI bus, the bus is stuck in a SCSI phase and cannot change to another phase or the SCSI cable from the system to the first device is defective.

1. Ensure that the SCSI cable from the system to the first device is connected.
  2. Disconnect all but the first tape drive on the SCSI bus. Move the terminator to the first SCSI device.
  3. Run an application to determine whether the error will occur.
    - o If the error occurs, do the following:
      - n Replace the SCSI terminator and retry the failing operation.
      - n Replace the SCSI cable and interposers, if any, and retry the failing operation.
      - n If these measures do not correct the problem, contact Dell technical support.
    - o If the error does not occur, connect one tape drive at a time back to the bus and repeat step 3 for each tape drive until you can identify which drive is defective.
-  **NOTE:** Ensure that the SCSI terminator is always on the last tape drive on the SCSI bus.
4. Determine if the problem is with only one tape drive or with two or more tape drives.
    - o If the problem is with only one tape drive, do the following:
      - n Replace the SCSI terminator and retry the failing operation.
      - n Replace the SCSI cable and interposers, if any, and retry the failing operation.
      - n If these measures do not correct the problem, contact Dell technical support.
    - o If the problem is with two or more tape drives, locate the first tape drive that has the error and replace the SCSI cable that connects the tape drive and the interposer (if installed).

### Fixing an Intermittent Error with a Single Drive on a SCSI Bus

1. Replace the SCSI terminator on the tape drive.
2. Run the operation that caused the error. If the problem persists, the problem may be with the cable.
3. Isolate which cable is causing the problem by replacing one cable at a time and running the operation that caused the error after each replacement.
4. If the problem persists, contact Dell technical support.

### Fixing an Intermittent Error With Multiple Drives on a SCSI Bus

Refer to the system's error logs to determine which tape drive is the source of the problem:

1. If only one tape drive is reporting a SCSI failure, contact Dell technical support.
1. If multiple tape drives are reporting SCSI failures, the problem may be with the terminator or the SCSI cables:
  - o Replace the terminator and run the operation that caused the error. If the problem persists, the problem may be with the cables.
  - o Isolate which cable is causing the problem by replacing one cable at a time and run the operation that caused the error after each replacement.

---



## Resolving Media-Related Problems

To resolve problems that are related to media, the tape drive's firmware includes:

1. Test Cartridge & Media diagnostic that verifies whether a suspect cartridge and its magnetic tape are acceptable for use.
1. Statistical Analysis and Reporting System (SARS) to assist in isolating failures between media and hardware. To determine the cause of failure, SARS uses the cartridge performance history that is saved in the cartridge memory (CM) and the drive performance history that is kept in the drive's Vital Product Data (VPD) area in Non Volatile Random Access Memory (NVRAM). Any failures that SARS detects are reported as TapeAlert flags on the system (see "[TapeAlert Flags](#)").

If you encounter a media-related problem, use the following procedure:

 **NOTICE:** When you run the Test Cartridge & Media diagnostic, data on the suspect tape is overwritten. If valuable data is on the tape, be sure to copy the data before running this test.

1. If possible, run the tape cartridge in a different tape drive. If the operation in the other tape drive fails and  or  displays, replace the media. If the operation succeeds, run the Test Cartridge & Media diagnostic (see Function Code E in "[Selecting a Diagnostic or Maintenance Function](#)").
2. If the Test Cartridge & Media diagnostic fails, replace the media. If it runs successfully, clean the tape drive and run the tape drive diagnostics (see the Cleaning the Tape Mechanism section in "[Using the Tape Drive](#)" and Function Code 1 in "[Selecting a Diagnostic or Maintenance Function](#)").
3. If the tape drive diagnostics fail, contact Dell technical support. If the tape drive diagnostics run successfully, perform the operation that produced the initial media error.

---

## Removing a Tape Drive

To remove the tape drive from the system, perform the following steps:

1. Ensure that the tape drive does not contain a tape cartridge.
2. Deconfigure the drive from the system (for instructions, see your system's documentation).
3. Turn off the power to the system. Disconnect the power cable from the system and the electrical outlet.
4. Remove system cover.

5. Disconnect the internal power cable from the power connector (see number 3 in [Figure 1](#)).
6. Disconnect the internal SCSI ID cable from the SCSI ID connector (see number 2 in [Figure 1](#)).
7. Disconnect the internal SCSI cable from the SCSI connector (see number 1 in [Figure 1](#)).
8. Remove the tape drive from the system and remove any mounting screws or rails from the side or bottom of the tape drive.
9. To reassemble, reverse these steps.

**Figure 1. Rear View of the Tape Drive**

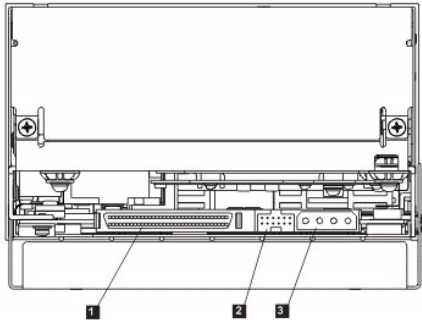

## Tape Alert

TapeAlert is a patented technology and standard of the American National Standards Institute (ANSI) that defines conditions and problems that are experienced by tape drives. The technology enables a system to read TapeAlert flags from a tape drive through the SCSI interface. The system reads the flags from Log Sense Page 0x2E.

### TapeAlert Flags

Table 5 lists the TapeAlert flags that are supported by the Dell PowerVault 110T LTO-3 Tape Drive.

**Table 5. TapeAlert Flags and Descriptions**

TapeAlert Flags Supported by the Tape Drive				
Flag Number	Flag Parameter (in hex)	Flag	Description	Action Required
3	03h	Hard error	Set for any unrecoverable read, write, or positioning error. (This flag is set in conjunction with flags 4, 5, or 6.)	See the Action Required column for Flag 4, 5, or 6 in this table.
4	04h	Media	Set for any unrecoverable read, write, or positioning error that is due to a faulty tape cartridge.	Contact Dell technical support.
5	05h	Read failure	Set for any unrecoverable read error where isolation is uncertain and failure could be due to a faulty tape cartridge or to faulty drive hardware.	If Flag 4 is also set, the cartridge is defective. Contact Dell technical support. If Flag 4 is not set, see error code 6 in " <a href="#">Descriptions and Corrective Actions</a> ."
6	06h	Write failure	Set for any unrecoverable write or positioning error where isolation is uncertain and failure could be due to a faulty tape cartridge or to faulty drive hardware.	If Flag 9 is also set, make sure that the write-protect switch is set so that data can be written to the tape (see the Setting the Write-Protect Switch section in " <a href="#">Using the Tape Drive</a> "). If Flag 4 is also set, the cartridge is defective. Replace the tape cartridge. If Flag 4 is not set, see error code 6 in " <a href="#">Descriptions and Corrective Actions</a> ."
8	08h	Not data grade	Set when severe servo errors occur while loading a tape cartridge.	Replace the tape cartridge. If this error occurs with multiple tapes, see error code 6 in " <a href="#">Descriptions and Corrective Actions</a> ."
9	09h	Write protect	Set when the tape drive detects that the tape cartridge is write-protected.	Make sure that the cartridge's write-protect switch is set so that the tape drive can write data to the tape (see the Setting the Write-Protect Switch section in " <a href="#">Using the Tape Drive</a> ").
10	0Ah	No removal	Set when the tape drive receives an UNLOAD command after the system prevented the tape cartridge from being removed.	Refer to the documentation for your system's operating system.
11	0Bh	Cleaning media	Set when you load a cleaning cartridge into the drive.	No action required.
12	0Ch	Unsupported format	Set when you load an unsupported cartridge type into the drive or when the cartridge format has been corrupted.	Use a supported tape cartridge.
15	0Fh	Cartridge memory chip failure	Set when a cartridge memory (CM) failure is detected on the loaded tape cartridge.	Replace the cartridge. If this error occurs on multiple tapes, see error code 6 in " <a href="#">Descriptions and Corrective Actions</a> ."
16	10h	Forced eject	Set when you manually unload the tape cartridge while the drive was reading or writing.	No action required.
18	12h	Tape directory corrupted in the cartridge memory	Set when the drive detects that the tape directory in the cartridge memory has been corrupted.	Reread all data from the tape to rebuild the tape directory.

20	14h	Clean now	Set when the tape drive detects that it needs cleaning.	Clean the tape drive. See the Cleaning the Tape Mechanism section in " <a href="#">Using the Tape Drive</a> ."
21	15h	Clean periodic	Set when the drive detects that it needs routine cleaning.	Clean the tape drive as soon as possible. The drive can continue to operate, but you should clean the drive soon. See the Cleaning the Tape Mechanism section in " <a href="#">Using the Tape Drive</a> ."
22	16h	Expired clean	Set when the tape drive detects a cleaning cartridge that has expired.	Replace the cleaning cartridge.
23	17h	Invalid cleaning tape	Set when the drive expects a cleaning cartridge and the loaded cartridge is not a cleaning cartridge.	Use a valid cleaning cartridge.
30	1Eh	Hardware A	Set when a hardware failure occurs that requires that you reset the tape drive to recover.	If resetting the drive does not recover the error, use the error code from the single-character display, library user interface, or SCSI drive sense data. See " <a href="#">Descriptions and Corrective Actions</a> ."
31	1Fh	Hardware B	Set when the tape drive fails its internal self tests.	Use the error code on the single-character display, library user interface, or SCSI drive sense data. See " <a href="#">Descriptions and Corrective Actions</a> ."
32	20h	Interface	Set when the tape drive detects a problem with the SCSI, Fibre Channel, or LDI (RS-422) interface.	Locate error code 8 or 9 in " <a href="#">Descriptions and Corrective Actions</a> ."
33	21h	Eject media	Set when a failure occurs that requires you to unload the cartridge from the drive.	Unload and reload the tape cartridge.
34	22h	Download fail	Set when a field microcode replacement (FMR) image is unsuccessfully downloaded to the tape drive via the SCSI interface.	Ensure that it is the correct image. Download the FMR image again.
36	24h	Drive temperature	Set when the drive's temperature sensor indicates that the drive's temperature is exceeding the recommended temperature of the system (see " <a href="#">Specifications</a> ").	See error code 1 in " <a href="#">Descriptions and Corrective Actions</a> ."
37	25h	Drive voltage	Set when the drive detects that the externally supplied voltages are either approaching the specified voltage limits or are outside the voltage limits (see " <a href="#">Specifications</a> ").	See error code 2 in " <a href="#">Descriptions and Corrective Actions</a> ."
39	27h	Diagnostics required	Set when the drive detects a failure that requires diagnostics to isolate the problem.	See error code 6 in " <a href="#">Descriptions and Corrective Actions</a> ."
51	33h	Tape directory invalid at unload	Set when the tape directory on the tape cartridge that was previously unloaded is corrupted. The file-search performance is degraded.	Rebuild the tape directory by reading all the data.
52	34h	Tape system area write failure	Set when the tape cartridge that was previously unloaded could not write its system area successfully.	Copy the data to another tape cartridge, then discard the old cartridge.
53	35h	Tape system area read failure	Set when the tape system area could not be read successfully at load time.	Copy the data to another tape cartridge, then discard the old cartridge.

## Manually Removing a Tape Cartridge

If problem-determination procedures identify the tape drive as the source of the problem and you are unable to eject the tape cartridge using the eject button, reset the drive to recover the cartridge:

- Press and hold the eject button for 10 seconds, then release.
  - The status light turns amber and the drive starts through its hardware test process.
  - When the hardware test completes, the status light turns green.
  - If a cartridge is in the drive the status light flashes green until the cartridge is rewind.
  - The status light turns solid green when the rewind is complete and the tape drive is ready.

 NOTE: Allow at least 10 minutes for the rewind process to complete.
- To eject the cartridge, push the eject button one more time. If the tape cartridge still will not eject, contact trained service personnel for assistance.



NOTICE: If you are not a trained service person, do not attempt to open the drive for repairs as this will void your warranty.

Please read all [restrictions and disclaimers](#).

[Back to Contents Page](#)

## Using the Tape Drive: Dell™ PowerVault™ 110T LTO-3 Tape Drive User's Guide

- [Operating the Drive](#)
  - [Loading, Unloading and Write-Protecting Cartridges](#)
  - [Caring for Tape Cartridges](#)
  - [Cleaning the Tape Mechanism](#)
- 

### Operating the Drive

Turn on external drives by pushing the power on/off button on the front panel (see number 1 in Figure 1). The tape drive will run its Power-On Self-Test (POST). At the end of the hardware self-test, the status light should be solid green.

Figure 1. Turning on the External Drive

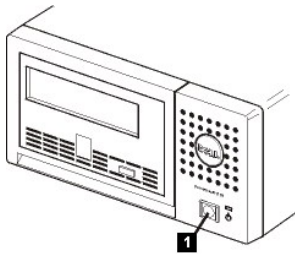

### Resetting the Drive

You can reset the drive without powering off the drive and system. This may be necessary if the drive stops responding. To do this, press and hold the eject button on the front panel of the tape drive for 10 seconds (see number 1 in Figure 2). The drive forces a dump of vital technical data to drive memory and overwrites the existing dump. The drive then reboots to allow communication.

Figure 2. Resetting the Drive

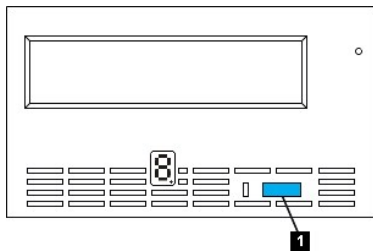

---

### Loading, Unloading, and Write-Protecting Cartridges

Only use LTO Ultrium format cartridges with your drive, as specified in the LTO Ultrium standard. Ensure that only one label is stuck to the label area of the cartridge. Never use nonstandard labels, and never stick anything to the cartridge other than in the label area.

The tape drive uses the following cartridge types:

- 1 LTO Ultrium 100-GB Data Cartridge (Generation 1)
- 1 LTO Ultrium 200-GB Data Cartridge (Generation 2)
- 1 LTO Ultrium 400-GB Data Cartridge (Generation 3)
- 1 LTO Ultrium Universal Cleaning Cartridge
- 1 LTO Ultrium 400-GB WORM Data Cartridge (Generation 3) (with write once read many (WORM) firmware)



NOTE: An LTO WORM cartridge can be written and appended but cannot be erased or overwritten. WORM cartridges are supported on drives with WORM firmware. See your sales or support personnel for WORM firmware availability dates.

The Dell PowerVault 110T LTO-3 Tape Drive is compatible with the cartridges of its predecessor, the Dell PowerVault 110T LTO-2 Tape Drive. Cartridge compatibility for the LTO-3 tape drive is as follows:

- 1 Reads and writes Generation 3 format from Generation 3 cartridges.
- 1 Reads and writes Generation 2 format from Generation 2 cartridges.
- 1 Reads Generation 1 format from Generation 1 cartridges.
- 1 Does not write Generation 3 format on Generation 2 cartridges.
- 1 Does not reformat Generation 2 cartridges to Generation 3 format.

Figure 3 shows the LTO Ultrium 400-GB Data Cartridge and its components.

Figure 3. LTO Ultrium 400-GB Data Cartridge

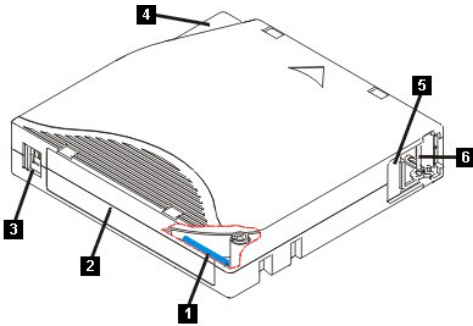

1. LTO cartridge memory
2. Label area
3. Write-protect switch
4. Insertion guide
5. Cartridge door
6. Leader pin

### Loading a Tape Cartridge

1. Ensure that the tape drive is powered on (the status light is solid green).
2. Ensure that the write-protect switch (see number 3 in [Figure 4](#)) is properly set. (See "[Setting the Write-Protect Switch on Cartridges](#)").
3. Grasp the cartridge so that the write-protect switch faces you.
4. Slide the cartridge into the tape load compartment (see [Figure 4](#)).
  - o If the cartridge is already in the ejected position and you want to reinsert it, remove the cartridge and then insert it again.
  - o If the cartridge is already loaded and you cycle the power (turn it off, then on), the tape will reload.

Figure 4. Loading

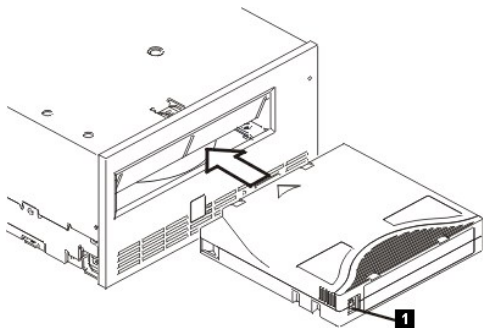

### Unloading a Tape Cartridge

1. Ensure that the tape drive is powered on (the status light is solid green).
2. Press the eject button (see number 1 in [Figure 2](#)). The drive rewinds the tape and partially ejects the cartridge. The status light flashes green while the tape rewinds, then goes out before the cartridge partially ejects.
3. After the cartridge partially ejects, grasp the cartridge and remove it.

Whenever you unload a tape cartridge, the tape drive writes any pertinent information to the cartridge memory.

- ➔ NOTICE: Do not remove a tape cartridge while the drive activity indicator is on.

### Setting the Write-Protect Switch on Tape Cartridges

- ➔ NOTICE: Write-protection will not prevent a cartridge from being erased by bulk-erasure or degaussing. Do not bulk erase Ultrium format cartridges. This will destroy prerecorded servo information and render the cartridge unusable. Always use the long or quick erase command in your backup software to erase cartridges.

The position of the write-protect switch (number 1 in [Figure 5](#)) on the tape cartridge determines whether you can write to the tape:

- 1 If the switch is set to locked (locked padlock), data cannot be written to the tape.
- 1 If the switch is set to unlocked (unlocked padlock or black void), data can be written to the tape.

Figure 5. Setting the Write-Protect Switch

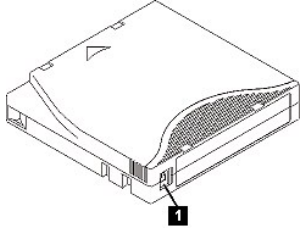

To set the switch, slide it left or right to the desired position. If you slide the red tab after the cartridge is inserted in the drive, the change will not take effect until the cartridge is removed and reinserted.

## Caring for Tape Cartridges



**NOTICE:** Do not insert a damaged tape cartridge into your tape drive. A damaged cartridge can interfere with the reliability of the drive and may void the warranties of the drive and the cartridge. Before inserting a tape cartridge, inspect the cartridge case, cartridge door, and write-protect switch for breaks.

Incorrect handling or an incorrect environment can damage the LTO Ultrium Tape Cartridge or its magnetic tape. To avoid damage to your tape cartridges and to ensure the continued high reliability of your tape drive, use the following guidelines.

### Provide Training

- 1 Post procedures that describe proper media handling in places where people gather.
- 1 Ensure that anyone who handles tape has been properly trained in handling and shipping procedures. This includes operators, users, programmers, archival services, and shipping personnel.
- 1 Ensure that any service or contract personnel who perform archiving are properly trained in media-handling procedures.
- 1 Include media-handling procedures as part of any services contract.
- 1 Define and make personnel aware of data recovery procedures.

### Ensure Proper Packaging

- 1 When you ship a cartridge, ship it in its original or better packaging.
- 1 Always ship or store a cartridge in a jewel case.
- 1 Use only a recommended shipping container that securely holds the cartridge in its jewel case during transportation.
- 1 Never ship a cartridge in a commercial shipping envelope. Always place it in a box or package.
- 1 If you ship the cartridge in a cardboard box or a box of a sturdy material, ensure the following:
  - o Place the cartridge in polyethylene plastic wrap or bags to protect it from dust, moisture, and other contaminants.
  - o Pack the cartridge snugly; do not allow it to move around.
  - o Double-box the cartridge (place it inside a box, then place that box inside the shipping box) and add padding between the two boxes

### Provide Proper Acclimation and Environmental Conditions

- 1 Before you use a cartridge, let it acclimate to the normal operating environment for 1 hour. If you see condensation on the cartridge, wait an additional hour.
- 1 Ensure that all surfaces of a cartridge are dry before inserting it.
- 1 Do not expose the cartridge to moisture or direct sunlight.
- 1 Do not expose recorded or blank cartridges to stray magnetic fields of greater than 100 oersteds (for example, terminals, motors, video equipment, X-ray equipment, or fields that exist near high-current cables or power supplies). Such exposure can cause the loss of recorded data or make the blank cartridge unusable.
- 1 Maintain the following environmental conditions outlined in the [Table 1](#).

**Table 1. Environmental Specifications**

Environmental Factor	Operating	Operational Storage <sup>1</sup>	Archival Storage <sup>2</sup>	Shipping
Temperature	10° to 45°C (50° to 113°F)	16° to 35°C (61° to 95°F)	16° to 25°C (61° to 77°F)	-23° to 49°C (-9° to 120°F)
Relative humidity (noncondensing)	10% to 80%	20% to 80%	20% to 50%	5% to 80%
Wet bulb temperature	26°C (79°F)	26°C (79°F)	26°C (79°F)	26°C (79°F)
<b>Notes:</b>				
1. Operational storage equals less than 1 year.				
2. Archival storage equals 1 to 10 years.				

### Perform a Thorough Inspection

- 1 Inspect the cartridge's packaging to determine potential rough handling.
- 1 When inspecting a cartridge, open only the cartridge door. Do not open any other part of the cartridge case. The upper and lower parts of the case are held together with screws; separating them destroys the usefulness of the cartridge.
- 1 Inspect the cartridge for damage before using or storing it.
- 1 Inspect the rear of the cartridge (the part that you load first into the tape load compartment) and ensure that there are no gaps in the seam of the cartridge case. If there are gaps in the seam, the leader pin may be dislodged.
- 1 Check that the leader pin is properly seated.
- 1 If you suspect that the cartridge has been mishandled but it appears useable, copy any data onto a good cartridge immediately for possible data recovery. Discard the mishandled cartridge.
- 1 Review handling and shipping procedures.

### Handle the Cartridge Carefully

- 1 Do not drop the cartridge. If the cartridge drops, slide the cartridge door back and ensure that the leader pin is properly seated in the pin-retaining spring clips.
  - 1 Do not handle tape that is outside the cartridge. Handling the tape can damage the tape's surface or edges, which may interfere with read or write reliability. Pulling on tape that is outside the cartridge can damage the tape and the brake mechanism in the cartridge.
  - 1 Do not stack more than six cartridges.
  - 1 Do not degauss a cartridge that you intend to reuse. Degaussing makes the tape unusable.
- 

## Cleaning the Tape Mechanism

Dell PowerVault 110T LTO-3 drives have been developed to have a minimal cleaning requirement. The tape drive will display a **C** on the single-character display and the status light will flash amber when the drive needs cleaning. Only insert a cleaning cartridge into the tape drive when the **C** is displayed.



NOTICE: Only use LTO cleaning cartridges that are labeled "universal." Some Generation 1 cleaning cartridges may not be the universal type. The Generation 3 tape drive is only compatible with the LTO Ultrium universal cleaning cartridges. Use of any other type of cleaning cartridge or method can damage the read/write head in your drive. If you load any other type of cleaning cartridge, the tape drive ejects it immediately.

An LTO Ultrium universal cleaning cartridge is supplied with each tape drive. Do *not* use swabs or other means of cleaning the heads. The cleaning cartridge uses a special tape to clean the tape heads.

Though the number may vary according to the manufacturer, the universal cleaning cartridge is generally valid for 50 cleanings. If the cleaning cartridge is ejected immediately, then it has expired or it is not a supported cleaning cartridge. Discard it and use a new one.

To use the LTO Ultrium universal cleaning cartridge:

1. Insert a cleaning cartridge into the tape drive. The tape drive performs the cleaning automatically. When the cleaning is finished, the drive ejects the cartridge.
  2. Remove the cleaning cartridge from the drive.
- 

Please read all [restrictions and disclaimers](#).

---

[Back to Contents Page](#)