

Dell™ PowerConnect™ 6200 Series

User's Guide

Model PC6224, PC6248, PC6224P, PC6248P, and PC6224F

Notes, Cautions, and Warnings



A NOTE indicates important information that helps you make better use of your computer.



A CAUTION indicates potential damage to hardware or loss of data if instructions are not followed.



WARNING: A WARNING indicates a potential for property damage, personal injury, or death.

Information in this document is subject to change without notice.

© 2011 Dell Inc. All rights reserved.

Reproduction of these materials in any manner whatsoever without the written permission of Dell Inc. is strictly forbidden.

Trademarks used in this text: *Dell*, the *DELL* logo, *PowerEdge*, *PowerConnect*, and *OpenManage* are trademarks of Dell Inc.; *Microsoft* and *Windows* are either trademarks or registered trademarks of Microsoft Corporation in the United States and/or other countries; *sFlow* is a registered trademark of InMon Corporation. *Cisco* is a registered trademark of Cisco Systems, Inc. and/or its affiliates in the United States and certain other countries.

Other trademarks and trade names may be used in this document to refer to either the entities claiming the marks and names or their products. Dell Inc. disclaims any proprietary interest in trademarks and trade names other than its own.

Model PC6224, PC6248, PC6224P, PC6248P, and PC6224F

March 2011

Rev. A04

Contents

1	Introduction	
	System Features	20
	Switching Features	23
	Port-Based Features	25
	Virtual Local Area Network Supported Features	26
	Spanning Tree Protocol Features	28
	Link Aggregation Features	29
	IP Phone and Access Point Support Features	29
	Routing Features	31
	MAC Address Supported Features	32
	IPv4 Routing Features	33
	IPv6 Routing Features	33
	IPv6	34
	OSPFv3	35
	Quality of Service Features	35
	Multicast Features	36
	IPv4 Multicast Features	36
	IPv6 Multicast Features	36
	Security Features	37
	Additional Documentation	38
2	Using Dell™ OpenManage™ Switch Administrator	
	Setting the IP Address of the Switch	40
	Setting DHCP on the Management Interface	40
	Setting a Static Address on the Management Interface	40
	Starting the Application	41
	Understanding the Interface	41
	Using the Switch Administrator Buttons	44
	Information Buttons	44

Device Management Buttons	44
Check Boxes	45
Defining Fields	45
Accessing the Switch Through the CLI	45
Console Connection.	46
Telnet Connection.	46
Using the CLI	46
Command Mode Overview	46
User EXEC Mode	47
Privileged EXEC Mode	47
Global Configuration Mode	48
Interface Configuration Mode	48

3 Cable and Port Information

Overview	49
Ethernet Interface	50
SFP Interfaces	51
Bay 1 and Bay 2 Interfaces	52
Serial Cable Connection	52
Connecting the Switch to a Terminal	52

Power Connection	53
4 Hardware Description	
Overview	55
Front Panel	56
Rear Panel	59
Console (RS-232) Port	61
Physical Dimensions	61
Power Supplies	62
Ventilation System	62
Stacking	62
Stacking Standby	63
LED Definitions	64
SFP Port LEDs	64
SFP+ Port LEDs	65
XFP Module Port LEDs	65
10/100/1000 Base-T Port LEDs	65
System LEDs	67
Stacking LEDs	68
5 Configuring Dell PowerConnect	
Overview	71
Starting the CLI	72
General Configuration Information	74
Terminal Connection Configuration	74
Baud Rate	74
Other Configuration Requirements	74
Booting the Switch	75
Configuration Overview	81
Easy Setup Wizard	81

Advanced Configuration	87
CLI Basics	87
6200 Series CLI Reference Guide	88
Security Management and Password Configuration	91
Software Download and Reboot	94
Software Download Through XModem	94
Software Download Through TFTP Server	94
Update Bootcode	97
Boot Menu Functions	97
Start Operational Code	98
Change the Baud Rate	99
Retrieve Event Log using XMODEM	99
Load New Operational Code Using XMODEM	100
Display Operational Code Vital Product Data	100
Abort Boot Code Update	101
Update Boot Code	101
Delete Backup Image	102
Reset the System	103
Restore Configuration to Factory Defaults	103
Activate Backup Image	103
Password Recovery Procedure	104
Reformat and Restore File System	104
Sample Configuration Process	105
Switch Setup Requirements	105
Initial Connection	105
Device Default Settings	111
Enabling Remote Management	111
Configuring Secure Management Access (HTTPS)	114

6 Configuring System Information

Overview	115
Defining General Device Information	116
Asset	116
System Health	118
Versions	119
System Resources	120

Time Zone Configuration	122
Summer Time Configuration	123
Clock Detail	125
Reset	126
Configuring SNTP Settings	127
SNTP Global Settings	128
SNTP Authentication	129
SNTP Server	132
Managing Logs	135
Global Settings	136
RAM Log Table	138
Log File	139
Remote Log Server Settings	140
Defining IP Addressing	143
Domain Name Server (DNS)	144
Default Domain Name	145
Host Name Mapping	146
Dynamic Host Name Mapping	148
ARP Table	149
IPv6 Management Features	150
Running Cable Diagnostics	152
Integrated Cable Test for Copper Cables	152
Optical Transceiver Diagnostics	154
Managing Device Security	157
Access Profile	157
Authentication Profiles	162
Select Authentication	166
Password Management	169
Local User Database	171
Line Passwords	174
Enable Password	175
TACACS+ Settings	176
RADIUS Global Configuration	180
RADIUS Server Configuration	182
RADIUS Accounting Server Configuration	185
RADIUS Accounting Server Statistics	187
RADIUS Server Statistics	189

Authorization Network RADIUS	191
Telnet Server	191
Denial of Service	193
Captive Portal	195
CP Global Configuration	196
CP Configuration	197
CP Web Customization	200
Local User	203
User Group	205
Interface Association	207
CP Status	208
CP Activation and Activity Status	210
Interface Activation Status	211
Interface Capability Status	212
Client Summary	213
Client Detail	213
CP Interface Client Status	214
CP Client Status	215
Defining SNMP Parameters	218
SNMP v1 and v2	218
SNMP v3	218
SNMP Global Parameters	218
SNMP View Settings	220
Access Control Group	223
SNMPv3 User Security Model (USM)	225
Communities	229
Notification Filter	232
Notification Recipients	234
File Management	238
File System	238
Active Images	239
File Download	240
File Upload	242
Copy Files	244
Defining Advanced Settings	246
Auto Configuration	246

Defining Stacking	249
Overview	249
Synchronizing the Running Configuration between the Master and Standby Units	249
Configuring Stacking	250
Trap Manager	262
Trap Flags	262
OSPFv2 Trap Flags	264
OSPFv3 Trap Flags	267
Trap Log	270
sFlow	271
sFlow Agent Summary	272
sFlow Receiver Configuration	273
sFlow Sampler Configuration	275
sFlow Poll Configuration	277
Industry Standard Discovery Protocol	279
ISDP Global Configuration	279
Cache Table	281
Interface Configuration	282
ISDP Statistics	284
iSCSI Optimization	286
iSCSI Optimization Global Configuration	286
Configuring iSCSI Optimization Using CLI Commands	287

7 Configuring Switching Information

Overview	289
Configuring Network Security	290
Dot1x Authentication	290
Authenticated Users	296
Port Security	297
IP ACL Configuration	300
IP ACL Rule Configuration	302
MAC ACL Configuration	306
MAC ACL Rule Configuration	308
IPv6 Access Control Lists	311
IPv6 ACL Rule Configuration	314

ACL Bind Configuration	316
Configuring Ports	319
Global Parameters	319
Port Configuration	321
Protected Port Configuration	324
LAG Configuration	326
Storm Control	329
Configuring Traffic Mirroring	332
Port Mirroring	332
Flow Based Mirroring	334
Configuring Address Tables	336
Static Address Table	336
Dynamic Address Table	338
Configuring GARP	341
GARP Timers	341
Configuring the Spanning Tree Protocol	344
STP Global Settings	344
STP Port Settings	348
STP LAG Settings	350
Rapid Spanning Tree	353
MSTP Settings	354
MSTP Interface Settings	357
Configuring VLANs	360
VLAN Membership	360
Double VLAN	364
VLAN Port Settings	368
VLAN LAG Settings	370
Bind MAC to VLAN	372
Bind IP Subnet to VLAN	375
Protocol Group	377
GVRP Parameters	381
Configuring Voice VLAN	384
Aggregating Ports	386
LACP Parameters	386
LAG Membership	388
Assigning Ports to LAGs and LACPs Using CLI Commands	390

LAG Hash Configuration	390
LAG Hash Summary.	391
Managing Multicast Support	393
Multicast Global Parameters	393
Bridge Multicast Group.	394
Bridge Multicast Forward.	398
IGMP Snooping.	399
General IGMP Snooping	400
Global Querier Configuration	403
VLAN Querier	404
VLAN Querier Status	406
MFDB IGMP Snooping Table	407
MRouter Status.	409
MLD Snooping	410
MLD Snooping General.	410
MLD Snooping Global Querier Configuration.	412
MLD Snooping VLAN Querier.	414
FMLD Snooping VLAN Querier Status	416
MFDB MLD Snooping Table	417
Configuring the Link Layer Discovery Protocol (LLDP)	419
LLDP Configuration	419
LLDP Statistics	422
LLDP Connections.	425
Configuring Link Layer Discovery Protocol (LLDP) for Media Endpoint Devices	427
LLDP-MED Global Configuration	427
LLDP-MED Interface Configuration.	429
LLDP-MED Local Device Information.	431
LLDP-MED Remote Device Information	433
Creating Link Dependencies.	437
Link Dependency Summary.	437
Dynamic ARP Inspection.	440
DAI Global Configuration	440
DAI Interface Configuration	441
DAI VLAN Configuration	443
DAI ACL Configuration	444
DAI ACL Rule Configuration.	445

DAI Statistics	447
DHCP Snooping	448
DHCP Snooping Configuration	449
DHCP Snooping Interface Configuration	450
DHCP Snooping VLAN Configuration	453
DHCP Snooping Persistent Configuration	454
DHCP Snooping Static Bindings Configuration	456
DHCP Snooping Dynamic Bindings Summary	458
DHCP Snooping Statistics	459
DHCP Relay	461
DHCP Relay Global Configuration	461
DHCP Relay Interface Configuration	462
DHCP Relay Interface Statistics	464
DHCP Relay VLAN Configuration	465

8 Viewing Statistics and Remote Monitoring

Overview	469
Table Views	470
Interface Statistics	470
Etherlike Statistics	472
GVRP Statistics	473
EAP Statistics	476
Utilization Summary	477
Counter Summary	479
RMON	481
RMON Statistics	481
RMON History Control Statistics	484
RMON History Table	487
RMON Event Control	489
RMON Event Log	491
RMON Alarms	492
Charts	497
Ports Statistics	497
LAG Statistics	498

9 Configuring Routing

Overview	501
ARP	502
ARP Create	502
ARP Table Configuration	504
IP	507
IP Configuration	507
IP Statistics	508
IP Interface Configuration	512
OSPF	515
OSPF Configuration	515
Area Configuration	520
Stub Area Summary	524
Area Range Configuration	525
Interface Statistics	527
Interface Configuration	530
Neighbor Table	535
Neighbor Configuration	536
Link State Database	539
Virtual Link Configuration	541
Virtual Link Summary	547
Route Redistribution Configuration	548
Route Redistribution Summary	550
Nonstop Forwarding OSPF Graceful Restart	551
BOOTP/DHCP Relay Agent	553
BOOTP/DHCP Relay Agent Configuration	554
IP Helper	555
IP Helper Global Configuration	556
IP Helper Interface Configuration	558
IP Helper Statistics	560
RIP	562
RIP Configuration	563
RIP Interface Configuration	565
RIP Interface Summary	567
RIP Route Redistribution Configuration	569
RIP Route Redistribution Summary	572

Router Discovery	573
Router Discovery Configuration	573
Router Discovery Status	575
Router	576
Route Table	576
Best Routes Table	578
Route Entry Configuration	579
Configured Routes	582
Route Preferences Configuration	583
VLAN Routing	585
VLAN Routing Summary	585
VRRP	587
VRRP Configuration	588
VRRP Router Configuration	589
VRRP Virtual Router Status	594
VRRP Virtual Router Statistics	597
Tunnels	599
Tunnels Configuration	600
Tunnels Summary	602
Loopbacks	604
Loopbacks Configuration	604
Loopbacks Summary	608

10 Configuring IPv6

Overview	611
Global Configuration	612
Interface Configuration	614
Interface Summary	618
IPv6 Statistics	618
IPv6 Neighbor Table	624
DHCPv6	626
DHCPv6 Global Configuration	626
DHCPv6 Pool Configuration	627

Prefix Delegation Configuration	630
DHCPv6 Pool Summary	631
DHCPv6 Interface Configuration	632
DHCPv6 Server Bindings Summary	636
DHCPv6 Statistics	637
OSPFv3	639
OSPFv3 Configuration	639
OSPFv3 Area Configuration	643
OSPFv3 Stub Area Summary	648
OSPFv3 Area Range Configuration	649
OSPFv3 Interface Configuration	651
OSPFv3 Interface Statistics	654
OSPFv3 Neighbors	657
OSPFv3 Neighbor Table	660
OSPFv3 Link State Database	661
OSPFv3 Virtual Link Configuration	663
OSPFv3 Virtual Link Summary	666
OSPFv3 Route Redistribution Configuration	668
OSPFv3 Route Redistribution Summary	669
Nonstop Forwarding OSPFv3 Graceful Restart	671
IPv6 Routes	674
IPv6 Route Entry Configuration	674
IPv6 Route Table	675
IPv6 Route Preferences	677
Configured IPv6 Routes	678

11 Configuring Quality of Service

Overview	681
Differentiated Services	682
DiffServ Overview	682
Defining DiffServ	682
Diffserv Configuration	683
Class Configuration	684
Class Criteria	686
Policy Configuration	691
Policy Class Definition	694
Service Configuration	700

Service Detailed Statistics	701
Class of Service	703
Mapping Table Configuration	703
Interface Configuration	707
Interface Queue Configuration	708
Auto VoIP	711
Auto VoIP Global Configuration	711
Auto VoIP Interface Configuration	712

12 Configuring IP Multicast

Overview	715
Multicast	716
Multicast Global Configuration	716
Multicast Interface Configuration	719
Multicast Route Table.	720
Multicast Admin Boundary Configuration	721
Multicast Admin Boundary Summary	723
Multicast Static MRoute Configuration.	723
Multicast Static MRoute Summary	725
Distance Vector Multicast Routing Protocol	727
DVMRP Global Configuration	727
DVMRP Interface Configuration	728
DVMRP Configuration Summary	730
Next Hop Summary	732
Prune Summary.	733
Route Summary	734
Internet Group Management Protocol	736
IGMP Global Configuration	736
Routing Interface	737
Proxy Interface	745
Multicast Listener Discovery	753
MLD Global Configuration	753
MLD Routing Interface Configuration	754
MLD Routing Interface Summary.	755
MLD Routing Interface Cache Information.	758

MLD Routing Interface Source List Information	759
MLD Traffic	760
MLD Proxy Configuration	762
MLD Proxy Configuration Summary	763
Interface Membership Information	764
Interface Membership Information—Detailed	766
Protocol Independent Multicast	767
PIM Global Configuration	768
PIM Global Status	769
PIM Interface Configuration	770
Interface Summary	772
Candidate RP Configuration	773
Static RP Configuration	775
SSM Range Configuration	777
BSR Candidate Configuration	779
BSR Candidate Summary	780

13 Getting Help

Obtaining Assistance	784
Online Services	784
Automated Order-Status Service	785
Support Service	785
Dell Enterprise Training and Certification	785
Problems With Your Order	785
Product Information	786
Returning Items for Warranty Repair or Credit	786
Before You Call	786
Contacting Dell	788

Introduction

This section describes the switch user-configurable features. For a list of all features, see the software version release notes.



NOTE: Before proceeding, read the release notes for this product. Release notes are provided with the firmware available on the Dell Support website, support.dell.com.

The Dell™ PowerConnect™ 6200 series are standalone Layer 2 and 3 switches that extend the Dell PowerConnect LAN switching product range. These switches include the following features:

- 1U form factor, rack-mountable chassis design.
- Support for all data-communication requirements for a multi-layer switch, including layer 2 switching, IPv4 routing, IPv6 routing, IP multicast, quality of service, security, and system management features.
- High availability with hot swappable stack members.

The Dell PowerConnect 6224 switch supports 24 1000Base-T copper ports and 4 "combo" ports for RJ-45 or SFP interfaces. The Dell PowerConnect 6224P adds support for power-over-Ethernet (PoE) capability.

The Dell PowerConnect 6224F switch supports 24 1000Base-FX SFP ports and 4 "combo" ports for RJ-45 or SFP interfaces.

The Dell PowerConnect 6248 switch supports 48 1000Base-T copper ports and 4 "combo" ports for RJ-45 or SFP interfaces. The Dell PowerConnect 6248P adds support for PoE capability.

The topics covered in this section include:

- System Features
- Switching Features
- Routing Features
- IPv6
- Quality of Service Features
- Multicast Features
- Additional Documentation

System Features

sFlow

sFlow is the standard for monitoring high-speed switched and routed networks. sFlow Version 5 technology is built into network equipment and gives complete visibility into network activity, enabling effective management and control of network resources.

CDP Interoperability

Allows the PowerConnect switch to interoperate with Cisco™ devices running CDP.

Industry Standard Discovery Protocol (ISDP) is a proprietary Layer 2 network protocol which inter-operates with Cisco network equipment and is used to share information between neighboring devices (routers, bridges, access servers, and switches).

Auto Config

Auto Config is a software feature which provides for the configuration of a switch automatically when the device is initialized and no configuration file is found on the switch. Auto Config is accomplished in three phases:

1. Configuration or assignment of an IP address for the device
2. Assignment of a TFTP server
3. Obtaining a configuration file for the device from the TFTP server

Captive Portal

Blocks clients from accessing the network until user verification has been established. Verification can be configured to allow access for both guest and authenticated users. Authenticated users must be validated against a database of authorized Captive Portal users before access is granted.

SNMP Alarms and Trap Logs

The system logs events with severity codes and timestamps. The events are sent as SNMP traps to a trap recipient list.

For information about SNMP Alarms and Traps, see "Defining SNTP Global Parameters."

Web Based Management

You can manage the system from any web browser. The switch contains an embedded web server that serves HTML pages you can use to monitor and configure the system.

Configuration File Download

The switch's configuration file includes both system-wide and port-specific device configuration data. You can display configuration files through command-line interface (CLI) commands.

For information about downloading configuration files, see "Downloading Files."

Software Download

Software download enables storage of backup firmware images. For information about downloading the software, see "Software Download and Reboot."

Trivial File Transfer Protocol (TFTP)

The PowerConnect 6200 Series switches support boot image, firmware, and configuration upload or download through TFTP.

Remote Monitoring (RMON)

RMON is a standard Management Information Base (MIB) that defines current and historical MAC-layer statistics and control objects, allowing real-time information to be captured across the entire network.

Simple Network Management Protocol (SNMP) Versions 1, 2, and 3

The system is fully manageable using a combination of MIB variables, whose combined values represent all facets of the system state, and the SNMP protocol to examine and possibly modify these values. SNMP v1/v2c/v3 over the UDP/IP transport protocol is supported.

Command Line Interface

Command Line Interface (CLI) syntax and semantics conform as much as possible to common industry practice. CLI is composed of mandatory and optional elements. Context-sensitive help provides format and value ranges allowed for current commands, and the CLI interpreter provides command and keyword completion.

Syslog

Syslog is a protocol that allows event notifications to be sent to a set of desired remote servers where they can be stored, examined, and acted upon.

For information about Syslog, see "Managing Logs."

SNTP

The Simple Network Time Protocol (SNTP) assures accurate network switch clock time synchronization up to the millisecond. Time synchronization is performed by a network SNTP server.

For more information about SNTP, see "Configuring SNTP Settings."

Real Time Clock

The Real Time Clock feature allows the user to set the time and date for the switch.

For information about Real Time Clock, see "Clock Detail."

Configurable CX-4/Stacking Modules

This feature allows the stacking and CX-4 plug-in modules to be configured to either role (Ethernet or Stacking). By default, the module will function according to its module ID. Upon changing the role of a module, a reboot will be required for the change to take effect.

Non-stop Forwarding

This feature enables a stack to continue forwarding packets when the stack management unit fails due to a power failure, hardware failure, or software fault.

Switching Features

IPv6 Access Control Lists

An IPv6 ACL consists of a set of rules which are matched sequentially against a packet. When a packet meets the match criteria of a rule, the specified rule action (Permit/Deny) is taken and the additional rules are not checked for a match.

Access Control List (ACL) Outbound Support

This feature enables binding an ACL (IP, MAC, or IPv6) in outbound direction on physical, LAG, and VLAN interfaces.

IP Source Guard (IPSG)

IP source guard (IPSG) is a security feature that filters IP packets based on the source ID. The source ID may either be source IP address or a source IP address source MAC address pair. IPSG is disabled by default.

DHCP Snooping

DHCP Snooping is a security feature that monitors DHCP messages between a DHCP client and DHCP server. It filters harmful DHCP messages and builds a bindings database of (MAC address, IP address, VLAN ID, port) tuples that are specified as authorized. DHCP snooping can be enabled globally and on specific VLANs. Ports within the VLAN can be configured to be trusted or untrusted. DHCP servers must be reached through trusted ports.

DHCP L2 Relay

This feature permits L3 Relay agent functionality in L2 switched networks.

Dynamic ARP Inspection

Dynamic ARP Inspection (DAI) is a security feature that rejects invalid and malicious ARP packets. The feature prevents a class of man-in-the-middle attacks, where an unfriendly station intercepts traffic for other stations by poisoning the ARP caches of its unsuspecting neighbors. The miscreant sends ARP requests or responses mapping another station's IP address to its own MAC address.

Dynamic ARP Inspection relies on DHCP Snooping.

MLD Snooping

In IPv4, Layer 2 switches can use IGMP Snooping to limit the flooding of multicast traffic by dynamically configuring Layer 2 interfaces so that multicast traffic is forwarded to only those interfaces associated with IP multicast address.

In IPv6, MLD snooping performs a similar function. With MLD snooping, IPv6 multicast data is selectively forwarded to a list of ports intended to receive the data (instead of being flooded to all of the ports in a VLAN). This list is constructed by snooping IPv6 multicast control packets.

IGMP Snooping

Internet Group Management Protocol (IGMP) Snooping is a feature that allows a switch to forward multicast traffic intelligently on the switch. Multicast IP traffic is traffic that is destined to a host group. Host groups are identified by class D IP addresses, which range from 224.0.0.0 to 239.255.255.255. Based on the IGMP query and report messages, the switch forwards traffic only to the ports that request the multicast traffic. This prevents the switch from broadcasting the traffic to all ports and possibly affecting network performance.

Port Mirroring

Port mirroring monitors and mirrors network traffic by forwarding copies of incoming and outgoing packets from up to four source ports to a monitoring port.

Broadcast Storm Control

When Layer 2 frames are forwarded, broadcast, unknown unicast, and multicast frames are flooded to all ports on the relevant virtual local area network (VLAN). The flooding occupies bandwidth, and loads all nodes connected on all ports. Storm control limits the amount of broadcast, unknown unicast, and multicast frames accepted and forwarded by the switch.

Port-Based Features

Jumbo Frames Support

Jumbo frames enable transporting data in fewer frames to ensure less overhead, lower processing time, and fewer interrupts.

Auto-MDI/MDIX Support

The switch supports auto-detection between crossed and straight-through cables.

Media-Dependent Interface (MDI) is the standard wiring for end stations, and the standard wiring for hubs and switches is known as Media-Dependent Interface with Crossover (MDIX).

Auto Negotiation

Auto negotiation allows the switch to advertise modes of operation. The auto negotiation function provides the means to exchange information between two switches that share a point-to-point link segment, and to automatically configure both switches to take maximum advantage of their transmission capabilities.

The PowerConnect 6200 Series enhances auto negotiation by providing port advertisement. Port advertisement allows the system administrator to configure the port speeds advertised.

For information about auto negotiation, see "Port Configuration" or "LAG Configuration."

Flow Control Support (IEEE 802.3x)

Flow control enables lower speed switches to communicate with higher speed switches by requesting that the higher speed switch refrains from sending packets. Transmissions are temporarily halted to prevent buffer overflows.

For information about configuring flow control for ports or LAGs, see "Port Configuration" or "LAG Configuration."

Head of Line Blocking Prevention

Head of Line (HOL) blocking prevention prevents traffic delays and frame loss caused by traffic competing for the same egress port resources. HOL blocking queues packets, and the packets at the head of the queue are forwarded before packets at the end of the queue.

Back Pressure Support

On half-duplex links, a receiver may prevent buffer overflows by occupying the link so that it is unavailable for additional traffic.

Alternate Store and Forward (ASF)

The Alternate Store and Forward (ASF) feature reduces latency for large packets. When ASF is enabled, the memory management unit (MMU) can forward a packet to the egress port before it has been entirely received on the Cell Buffer Pool (CBP) memory. ASF, which is also known as cut-through mode, is configurable through the command-line interface. For information about how to configure the ASF feature, see the *CLI Reference Guide*, which is located on the Dell Support website at www.support.dell.com/manuals.

Link Dependency Features

The link dependency feature provides the ability to enable or disable one or more ports based on the state of the link of one or more ports.

For information about Link Dependency, see "Creating Link Dependencies."

Virtual Local Area Network Supported Features

VLAN Support

VLANs are collections of switching ports that comprise a single broadcast domain. Packets are classified as belonging to a VLAN based on either the VLAN tag or a combination of the ingress port and packet contents. Packets sharing common attributes can be groups in the same VLAN.

For information about configuring VLANs, see "Configuring VLANs."

Port-Based VLANs

Port-based VLANs classify incoming packets to VLANs based on their ingress port. When a port uses 802.1X port authentication, packets can be assigned to a VLAN based on the result of the 802.1X authentication a client uses when it accesses the switch. This feature is useful for assigning traffic to Guest VLANs or Voice VLANs.

For information about configuring VLANs, see "Configuring VLANs."

IEEE 802.1v Protocol-Based VLANs

VLAN classification rules are defined on data-link layer (Layer 2) protocol identification. Protocol-based VLANs are used for isolating Layer 2 traffic for differing Layer 3 protocols.

For information about defining Protocol-Based VLANs, see "Protocol Group."

Full 802.1Q VLAN Tagging Compliance

IEEE 802.1Q defines an architecture for virtual bridged LANs, the services provided in VLANs, and the protocols and algorithms involved in the provision of these services.

GVRP Support

GARP VLAN Registration Protocol (GVRP) provides IEEE 802.1Q-compliant VLAN pruning and dynamic VLAN creation on 802.1Q trunk ports. When GVRP is enabled, the switch registers and propagates VLAN membership on all ports that are part of the active spanning tree protocol topology.

For information about configuring GVRP, see "GVRP Parameters."

Protected Ports (Private VLAN Edge)

Private VLAN Edge (PVE) ports are a Layer 2 security feature that provides port-based security between ports that are members of the same VLAN. It is an extension of the common VLAN. Traffic from protected ports is sent only to the uplink ports and cannot be sent to other ports within the VLAN.

Subnet-based VLAN

This feature allows incoming untagged packets to be assigned to a VLAN and traffic class based on the source IP address of the packet.

For information about configuring Subnet-based VLANs, see "Bind IP Subnet to VLAN."

MAC-based VLAN

This feature allows incoming untagged packets to be assigned to a VLAN and traffic class based on the source MAC address of the packet.

For information about configuring MAC-based VLANs, see "Bind MAC to VLAN."

Double VLANs

The Double VLAN feature allows the use of a second tag on network traffic. The additional tag helps differentiate between customers in the Metropolitan Area Networks (MAN) while preserving individual customer's VLAN identification when they enter their own 802.1Q domain.

Protocol-based VLANs

In a protocol-based VLAN, traffic is bridged through specified ports based on the VLAN's protocol. User-defined packet filters determine if a particular packet belongs to a particular VLAN. Protocol-based VLANs are most often used in situations where network segments contain hosts running multiple protocols.

Spanning Tree Protocol Features

Spanning Tree Now Supports IEEE 802.1Q-2005

This version of the IEEE Multiple Spanning Tree Protocol corrects problems associated with the previous version, provides for faster transition-to-forwarding, and incorporates new features for a port (restricted role and restricted TCN).

Spanning Tree Enhancements

- **Loop Guard** — This feature prevents a port from erroneously transitioning from blocking state to forwarding when the port stops receiving BPDUs. The port is marked as being in loop-inconsistent state. In this state, the port does not forward packets. The possible values are Enable or Disable.
- **TCN Guard** — Enabling the TCN Guard feature restricts the port from propagating any topology change information received through that port. This means that even if a port receives a BPDU with the topology change flag set to true, the port will not flush its MAC address table and send out a BPDU with a topology change flag set to true.
- **Auto Edge** — Enabling the Auto Edge feature allows the port to become an edge port if it does not see BPDUs for some duration.
- **BPDU Filter** — When enabled, this feature filters the BPDU traffic on this port when STP is enabled on this port.
- **BPDU Flood** — When enabled, the BPDU Flood feature floods the BPDU traffic arriving on this port when STP is disabled on this port.

Spanning Tree Protocol (STP) per Switch

802.1d STP is a standard requirement of Layer 2 switches that allows bridges to automatically prevent and resolve L2 forwarding loops.

For information about configuring Spanning Tree Protocol, see "Configuring the Spanning Tree Protocol."

IEEE 802.1w Rapid Spanning Tree

Rapid Spanning Tree Protocol (RSTP) detects and uses network topologies to enable faster spanning tree convergence after a topology change, without creating forwarding loops.

For information about configuring Rapid Spanning Tree Protocol, see "Rapid Spanning Tree."

Multiple Spanning Tree

Multiple Spanning Tree (MSTP) operation maps VLANs to spanning tree instances. Packets assigned to various VLANs are transmitted along different paths within MSTP Regions (MST Regions). Regions are one or more interconnected MSTP bridges with identical MSTP settings. The MSTP standard lets administrators assign VLAN traffic to unique paths.

For information about configuring Multiple Spanning Tree, see "MSTP Settings."

Spanning Tree Root Guard

Spanning Tree Root Guard is used to prevent the root of a Spanning Tree instance from changing unexpectedly. The priority of a Bridge ID can be set to zero but another Bridge ID with a lower mac address could also set its priority to zero and take over root.

Bridge Protocol Data Unit Guard

Spanning Tree BPDU Guard is used to disable the port in case a new device tries to enter the already existing topology of STP. Thus devices, which were originally not a part of STP, are not allowed to influence the STP topology.

Link Aggregation Features

Link Aggregation

Up to eight ports can combine to form a single Link Aggregated Group (LAG). This enables fault tolerance protection from physical link disruption, higher bandwidth connections and improved bandwidth granularity.

A LAG is composed of ports of the same speed, set to full-duplex operation.

For information about configuring LAGs, see "LAG Configuration."

Link Aggregation and LACP

Link Aggregate Control Protocol (LACP) uses peer exchanges across links to determine, on an ongoing basis, the aggregation capability of various links, and continuously provides the maximum level of aggregation capability achievable between a given pair of systems. LACP automatically determines, configures, binds, and monitors the binding of ports to aggregators within the system.

For information about LACP, see "LACP Parameters."

IP Phone and Access Point Support Features

Power Over Ethernet (PoE) Configuration

The PowerConnect 6200 supports PoE configuration for power threshold, SNMP traps, and PoE legacy device support.

Link Layer Discovery Protocol (LLDP) for Media Endpoint Devices

The Link Layer Discovery Protocol for Media Endpoint Devices (LLDP-MED) provides an extension to the LLDP standard for network configuration and policy, device location, Power over Ethernet management, and inventory management.

For information about configuring LLDP-MED, see "Configuring Link Layer Discovery Protocol (LLDP) for Media Endpoint Devices."

Voice VLAN

The Voice VLAN feature enables switch ports to carry voice traffic with defined priority. The priority level enables the separation of voice and data traffic coming onto the port.

For information about configuring Voice VLAN, see "Configuring Voice VLAN."

Routing Features

VLAN Routing

The PowerConnect 6200 Series software supports VLAN routing. You can also configure the software to allow traffic on a VLAN to be treated as if the VLAN were a router port.

Routing Information Protocol (RIP)

The route configuration and route preference features have the following changes:

- You can configure static reject routes (see Static Reject Routes).
- The default values for route preferences have changed.
- OSPF Type-1 and OSPF Type-2 routes are now classified as OSPF External routes.

OSPF Configuration

The Maximum Paths field allows OSPF to report a maximum of 4 paths for a given destination.

The following fields have been added for OSPF configuration options:

- Opaque LSA Status
- AS_OPAQUE LSA Count
- AS_OPAQUE LSA Checksum
- External LSDB Limit
- AutoCost Reference Bandwidth
- Default Passive Setting
- Stub Area Type of Service
- NSSA Information

The **OSPF Link State Database** page has been updated to display external LSDB table information and AS opaque LSDB table information (in addition to OSPF link state information).

IP Configuration

The switch IP configuration settings have been enhanced to allow you to enable or disable the generation of the following types of ICMP messages:

- ICMP Echo Replies
- ICMP Redirects
- ICMP Rate Limit Interval
- ICMP Rate Limit Burst Size

IP Interface Configuration

IP interface configuration includes the ability to configure the bandwidth, Destination Unreachable messages, and ICMP Redirect messages.

IP Helper

Provides the ability to relay various protocols to servers on a different subnet.

VRRP Route Interface Tracking

Extends the capability of the Virtual Router Redundancy Protocol (VRRP) to allow tracking of specific route/interface IP state within the router that can alter the priority level of a virtual router for a VRRP group.

The exception to this is, if that VRRP group is the IP address owner, its priority is fixed at 255 and can not be reduced through tracking process.

MAC Address Supported Features

MAC Address Support

The switch supports up to 32K Media Access Control (MAC) addresses and reserves two MAC addresses for system use.

Self-Learning MAC Addresses

The switch enables MAC addresses to be automatically learned from incoming packets.

Automatic Aging for MAC Addresses

MAC addresses that have not seen any traffic for a given period are aged out, which prevents the bridging table from overflowing.

For information about configuring the MAC Address age-out period, see "Dynamic Address Table."

Static MAC Entries

User-defined MAC entries are stored in the Bridging Table with the self-learned addresses.

For information about configuring the static MAC addresses, see "Static Address Table."

VLAN-Aware MAC-based Switching

Packets arriving from an unknown source address are sent to the CPU and added to the Hardware Table. Future packets addressed to or from this address are more efficiently forwarded.

MAC Multicast Support

Multicast service is a limited broadcast service that allows one-to-many and many-to-many connections. In Layer 2 multicast services, a single frame addressed to a specific multicast address is received, and copies of the frame to be transmitted on each relevant port are created.

For information about configuring MAC Multicast Support, see "Managing Multicast Support."

IPv4 Routing Features

Address Resolution Protocol

The PowerConnect 6200 Series uses the ARP protocol to associate a layer 2 MAC address with a layer 3 IPv4 address. Additionally, the administrator can statically add entries in to the ARP table.

Open Shortest Path First

The Open Shortest Path First (OSPF) Routing protocol defines two area types: regular OSPF area and OSPF stub area. OSPF internal and external route information may be propagated throughout the regular OSPF area; it is capable of supporting transit traffic and virtual links.

BOOTP/DHCP Relay Agent

The BootP protocol allows a device to solicit and receive configuration data and parameters from a suitable server. DHCP is an extension to BootP allowing additional setup parameters to be received from a network server upon system startup. Notably, while BootP stops operating once an IP address is obtained, DHCP service is an on-going process. For example, the IP address assigned to the system has a 'lease time' that may expire, and can be renewed on the fly.

Routing Information Protocol

The routing protocol used within an autonomous Internet system is referred to as an interior gateway protocol (IGP). RIP is an IGP that is designed to work with moderate-size networks.

Virtual Routing Redundancy Protocol

Virtual Routing Redundancy Protocol (VRRP) is used to provide hosts with redundant routers in the network topology without any need for the hosts to reconfigure or know that there are multiple routers.

IPv6 Routing Features

IPv6 6 to 4 Auto Tunnels

Automatically formed IPv4 6 to 4 tunnels for carrying IPv6 traffic. The automatic tunnel IPv4 destination address is derived from the 6 to 4 IPv6 address of the tunnel nexthop. There is support the functionality of a 6 to 4 border router that connects a 6 to 4 site to a 6 to 4 domain. It sends/receives tunneled traffic from routers in a 6 to 4 domain that includes other 6 to 4 border routers and 6 to 4 relay routers.

DHCPv6

DHCPv6 incorporates the notion of the “stateless” server, where DHCPv6 is not used for IP address assignment to a client, rather it only provides other networking information such as DNS, Network Time Protocol (NTP), and/or Session Initiation Protocol (SIP) information.

OSPFv3

OSPFv3 provides a routing protocol for IPv6 networking. OSPFv3 is a new routing component based on the OSPF version 2 component. In dual stack IPv6, you can configure and use both OSPF and OSPFv3 components.

IPv6 Routes

Since IPv4 and IPv6 can coexist on a network, the router on such a network needs to forward both traffic types. Given this coexistence, the PowerConnect 6200 Series maintains two routing tables, rto and rto6, which are both capable of forwarding over the same set of interfaces. IPv6 interfaces are managed in a manner similar to IPv4 interfaces.

IPv6

IPv6 Route Configuration Enhancements

The route configuration and route preference features have the following changes:

You can configure static reject routes.

The default values for route preferences have changed as follows:

- OSPFv3 Intra — 110
- OSPFv3 Inter — 110
- OSPFv3 External — 110

OSPF Type-1 and OSPF Type-2 routes are now classified as OSPF External routes.

OSPFv3

The OSPFv3 Configuration page has been updated with the following changes:

- AutoCost Reference Bandwidth field
- Default Passive Setting field
- Maximum Paths increased from 2 to 4
- Passive Mode field

Quality of Service Features

Voice VLAN

The Voice VLAN feature enables switch ports to carry voice traffic with defined priority. The priority level enables the separation of voice and data traffic coming onto the port. A primary benefit of using Voice VLAN is to ensure that the sound quality of an IP phone is safeguarded from deteriorating when the data traffic on the port is high. The system uses the source MAC address of the traffic traveling through the port to identify the IP phone data flow.

Auto VoIP

Provides ease of use for the user in setting up VoIP for IP phones on a switch. This is accomplished by enabling a VoIP profile that a user can select on a per port basis.

Class of Service Rate Limiting

The Class of Service interface configuration feature has been enhanced to allow outbound rate limiting on specified ports.

Differentiated Services IPv6 Support

Extends the existing QoS ACL and DiffServ functionality by providing support for IPv6 packet classification. Ethernet IPv6 packets are distinguished from IPv4 packets by a unique Ethertype value (all IPv6 classifiers include the Ethertype field).

Quality of Service (QoS) Support

To overcome unpredictable network traffic and optimize performance, you can apply Quality of Service (QoS) throughout the network. QoS ensures that the network traffic is prioritized according to a specific criteria. Your switch supports two types of QoS: Differentiated Services and Class of Service.

- The QoS Differentiated Services (DiffServ) feature allows traffic to be classified into streams and given certain QoS treatment in accordance with defined per-hop behaviors.
- The Class Of Service (CoS) queuing feature lets you directly configure certain aspects of switch queuing. This provides the desired QoS behavior for different types of network traffic when the complexities of DiffServ are not required.

Multicast Features

IPv4 Multicast Features

Updated IPv4 Multicast Routing Support

The Multicast package code has been extensively re-engineered and furnished with the following:

- PIM-DM advanced to RFC 3973
- PIM-SM advanced to RFC 4601, pim-sm-bsr-05, draft-ietf-pim-mib-v2-03
- DVMRP advanced to draft-ietf-idmr-dvmrp-v3-10.txt, draft-ietf-idmr-dvmrp-mib-11.txt

Distance Vector Multicast Routing Protocol

Distance Vector Multicast Routing Protocol (DVMRP) exchanges probe packets with all DVMRP-enabled routers, establishing two way neighboring relationships and building a neighbor table. It exchanges report packets and creates a unicast topology table, which is used to build the multicast routing table. This multicast route table is then used to route the multicast packets.

Internet Group Management Protocol

The Internet Group Management Protocol (IGMP) is used by IPv4 systems (hosts and routers) to report their IP multicast group memberships to any neighboring multicast routers. The PowerConnect 6200 Series performs the "multicast router part" of the IGMP protocol, which means it collects the membership information needed by the active multicast routing.

Protocol Independent Multicast-Dense Mode

Protocol Independent Multicast (PIM) is a standard multicast routing protocol that provides scalable inter-domain multicast routing across the Internet, independent of the mechanisms provided by any particular unicast routing protocol. The Protocol Independent Multicast-Dense Mode (PIM-DM) protocol uses an existing Unicast routing table and a Join/Prune/Graft mechanism to build a tree. PIM-DM creates source-based shortest-path distribution trees, making use of reverse path forwarding (RPF).

Protocol Independent Multicast-Sparse Mode

Protocol Independent Multicast-Sparse Mode (PIM-SM) is used to efficiently route multicast traffic to multicast groups that may span wide area networks, and where bandwidth is a constraint. PIM-SM uses shared trees by default and implements source-based trees for efficiency. This data threshold rate is used to toggle between trees.

IPv6 Multicast Features

Protocol Independent Multicast IPv6 Support

PIM-DM and PIM-SM support IPv6 routes.

MLD/MLDv2 (RFC2710/RFC3810)

MLD is used by IPv6 systems (listeners and routers) to report their IP multicast addresses memberships to any neighboring multicast routers. The implementation of MLD v2 is backward compatible with MLD v1.

MLD protocol enables the IPv6 router to discover the presence of multicast listeners, the nodes that want to receive the multicast data packets, on its directly attached interfaces. The protocol specifically discovers which multicast addresses are of interest to its neighboring nodes and provides this information to the multicast routing protocol that make the decision on the flow of the multicast data packets.

Security Features

Access Control Lists (ACL)

Access Control Lists (ACLs) ensure that only authorized users have access to specific resources while blocking off any unwarranted attempts to reach network resources. ACLs are used to provide traffic flow control, restrict contents of routing updates, decide which types of traffic are forwarded or blocked, and above all provide security for the network.

For information about defining ACLs, see "IP ACL Configuration" and "MAC ACL Configuration."

Dot1x Authentication (802.1x)

Dot1x authentication enables the authentication of system users through an external server. Only authenticated and approved system users can transmit and receive data. Supplicants are authenticated through the Remote Authentication Dial In User Service (RADIUS) server using the Extensible Authentication Protocol (EAP). Also supported are PEAP, EAP-TTL, EAP-TTLS, and EAP-TLS. MAC-based authentication allows multiple supplicants connected to the same port to each authenticate individually. For example, a system attached to the port might be required to authenticate in order to gain access to the network, while a VoIP phone might not need to authenticate in order to send voice traffic through the port.

For information about enabling and configuring 802.1X port authentication, see "Dot1x Authentication."

Locked Port Support

The locked port feature limits access on a port to users with specific MAC addresses. These addresses are manually defined or learned on that port. When a frame is seen on a locked port, and the frame source MAC address is not tied to that port, the protection mechanism is invoked.

For information about enabling locked port security, see "Port Security."

Password Management Security

Password management provides increased network security and improved password control. Passwords for SSH, Telnet, HTTP, HTTPS, and SNMP access are assigned security features.

For more information about password management, see "Password Management."

TACACS+

TACACS+ provides centralized security for validation of users accessing the switch. TACACS+ provides a centralized user management system, while still retaining consistency with RADIUS and other authentication processes.

RADIUS Client

RADIUS is a client/server-based protocol in which the server maintains a user database that contains user authentication information, such as user name, password, and accounting information.

SSH/SSL

Secure Shell (SSH) is a protocol that provides a secure, remote connection to a device. This connection provides functionality that is similar to an inbound telnet connection.

Secure Sockets Layer (SSL) protocol provides a means of abstracting an encrypted connection between two stations. Once established, such a connection is virtually no different to use than an unsecured connection.

Additional Documentation

The following documents for the PowerConnect PowerConnect 6200 Series switches are available on the Dell Support website at www.support.dell.com/manuals:

- *Getting Started Guide*—provides information about the switch models in the series, including front and back panel features. It also describes the installation and initial configuration procedures.
- *CLI Reference Guide*—provides information about the command-line interface (CLI) commands used to configure and manage the switch and stack. The document provides in-depth CLI descriptions, syntax, default values, and usage guidelines.
- *Configuration Guide*—provides examples of how to use the PowerConnect 6200 Series in a typical network. It describes the advantages of specific functions that the PowerConnect 6200 Series provides and includes information about configuring those functions using the command line interface (CLI).

Using Dell™ OpenManage™ Switch Administrator

The topics covered in this section include:

- Setting the IP Address of the Switch
- Starting the Application
- Understanding the Interface
- Using the Switch Administrator Buttons
- Defining Fields
- Accessing the Switch Through the CLI
- Using the CLI

Setting the IP Address of the Switch

Two methods for setting the IP address are to use DHCP or to statically assign the address. See the section titled "Accessing the Switch Through the CLI" on page 45 to start the CLI.

Setting DHCP on the Management Interface

1. Type `enable` at the `console>` prompt, and press `<Enter>`.
2. At the `console#` prompt, type `config` and press `<Enter>`.
3. At the `console(config)#` prompt, type `ip address dhcp` and press `<Enter>`.
4. Type `exit`.
5. At the `console#` prompt, type `show ip interface management` and press `<Enter>`.

Setting a Static Address on the Management Interface

1. Type `enable` at the `console>` prompt, and press `<Enter>`.
2. At the `console#` prompt, type `config` and press `<Enter>`.
3. Type `ip address none`.
4. To configure an ip address of 10.256.24.64, with a netmask of 255.255.248.0, and a gateway of 10.256.24.1, type the following:

```
ip address 10.256.24.64 255.255.248.0
ip default-gateway 10.256.24.1
```
5. Type `exit`.
6. At the `console#` prompt, type `show ip interface management` and press `<Enter>`.

Starting the Application

1. Open a web browser.
2. Enter the switch's IP address (as defined in the CLI) in the address bar and press <Enter>. For information about assigning an IP address to a switch, see "Configuration Overview."
3. When the **Login** window displays, enter a user name and password.
 -  **NOTE:** The switch is not configured with a default password, and you can configure the switch without entering a password when you connect to the CLI by using the console port. Passwords are both case sensitive and alpha-numeric. For information about recovering a lost password, see "Password Recovery Procedure."
4. Click OK.
5. The Dell OpenManage Switch Administrator home page displays.

Understanding the Interface

The home page contains the following views:

- **Tree view** — Located on the left side of the home page, the tree view provides an expandable view of features and their components.
- **Device view** — Located on the right side of the home page, the device view is used to display such things as a view of the device, an information or table area, and/or configuration instructions.

Figure 2-1. Switch Administrator Components: PowerConnect 6200 Series

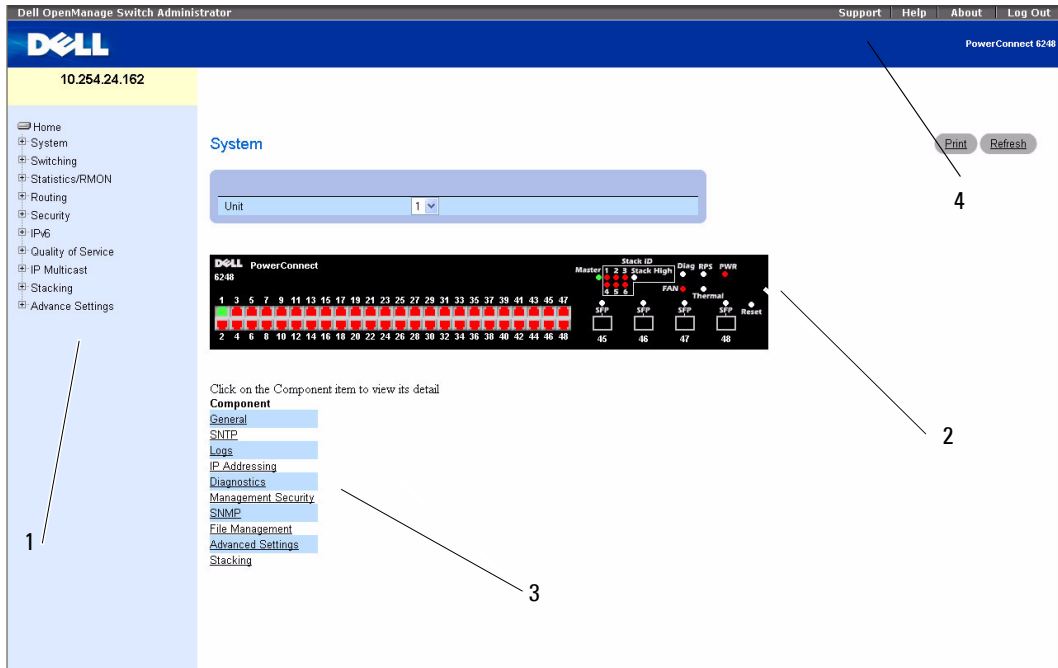



Table 2-1 lists the interface components with their corresponding numbers.

Table 2-1. Interface Components

Component	Name
1.	The tree view contains a list of various device features. The branches in the tree view can be expanded to view all the components under a specific feature, or retracted to hide the feature's components. By dragging the vertical bar to the right, you can expand the tree area to view a full name of a component.
2.	<p>The device view provides information about device ports, current configuration and status, table information, and feature components.</p> <p>The port coloring indicates if a port is currently active. Green indicates the port is enabled, red indicates that an error has occurred on the port, and blue indicates that the link is disabled.</p> <p> NOTE: The LED status does not appear in the device view. You can only determine LED status by looking at the actual switch. For information about LEDs, see "LED Definitions."</p> <p>Depending on which option you select, the area at the bottom of the device view displays other device information and/or dialogs for configuring parameters.</p>
3.	The components list contains a list of feature components. You can also view components by expanding a feature in the tree view.
4.	The information buttons provide access to information about the switch and access to Dell Support. For more information, see "Information Buttons."

Using the Switch Administrator Buttons

Information Buttons

Table 2-2. Information Buttons

Button	Description
Support	Opens the Dell Support page at support.dell.com
Help	Online help that contains information to assist in configuring and managing the switch. The online help pages are context sensitive. For example, if the IP Addressing page is open, the help topic for that page displays if you click Help .
About	Contains the version and build number and Dell copyright information.
Log Out	Logs out of the application.

Device Management Buttons

Table 2-3. Device Management Buttons

Button	Description
Apply Changes	Applies set changes to the device.
Add	Adds information to tables or dialogs.
Telnet	Starts a Telnet session.
Query	Queries tables.
Show All	Displays the device tables.
Left arrow/Right arrow	Moves information between lists.
Refresh	Refreshes device information.
Reset All Counters	Clears statistic counters.
Print	Prints the Network Management System page and/or table information.
Draw	Creates statistics charts on-the-fly.

Check Boxes

Table 2-4. Check Boxes

Check Box Type	Description
Add	Hyperlink that takes you to a configuration page.
Remove	Removes the selected item.
General selection	To enable a configuration item, i.e., adjust sensitivity of log files, select match criteria for diffserv, select ACL rule parameters.

Defining Fields

User-defined fields can contain 1–159 characters, unless otherwise noted on the Dell OpenManage Switch Administrator Web page.

All characters may be used except for the following:

- \
- /
- :
- *
- ?
- <
- >
- |

Accessing the Switch Through the CLI

The switch can be managed over a direct connection to the console port or through a Telnet connection.



NOTE: If you are managing a stack, ensure the serial interface cable is attached to the Master switch of the stack.

Using the CLI is similar to entering commands on a Linux system. If access is through a Telnet connection, ensure the device has an IP address defined and that the workstation used to access the device is connected to the device prior to using CLI commands.

For information about configuring an initial IP Address, see "Configuration Overview."

Console Connection

See "Serial Cable Connection" on page 52 for a description of the required console cable.

1. Turn on the switch (or stack) and wait until the startup is complete.

 **NOTE:** If you are installing a *stack* of switches, connect the terminal to the Master Switch. This switch lights the Master Switch LED. When a stack is powered up for the first time, the switches elect the Master Switch, which may occupy any location in the stack. If you connect the terminal to a subordinate switch, you cannot use the CLI through the subordinate's serial interface.

2. If the admin has not configured a login authentication method, then the `console>` prompt displays when the switch boots up. Otherwise, the user is presented with the `User: login` prompt.

 **NOTE:** The following steps assume that the admin user and password is configured on the system.

3. Type `admin` at the prompt, and press <Enter>.

The `Password:` prompt now displays.

4. Enter the password, which displays as asterisks (*).

The `console#` prompt now displays.

5. Configure the device and enter the necessary commands to complete the required tasks.
6. When finished, exit the session with the `quit` or `exit` command.

Telnet Connection

Telnet is a terminal emulation TCP/IP protocol. ASCII terminals can be virtually connected to the local device through a TCP/IP protocol network. Telnet is an alternative to a local login terminal where a remote login is required.

Your switch supports up to four simultaneous Telnet sessions. All CLI commands can be used over a telnet session.

Using the CLI

Command Mode Overview

The CLI is divided into command modes. Each command mode has a specific command set. Entering a question mark at the console prompt displays a list of commands available for that particular command mode.

In each mode, a specific command is used to navigate from one command mode to another.

During the CLI session initialization, the CLI mode is the User EXEC mode. Only a limited subset of commands are available in the User EXEC mode. This level is reserved for tasks that do not change the switch configuration and is used to access configuration sub-systems. Privileged EXEC mode may require a password if the enable password is configured. See "Security Management and Password Configuration" on page 91 for more information on setting up enable passwords.

The Privileged EXEC mode provides access to the device global configuration. For specific global configurations within the device, enter the next level, Global Configuration mode. A password is not required.

The Global Configuration mode manages the device configuration on a global level.

The Interface Configuration mode configures the device at the physical interface level. Interface commands, which require subcommands, have another level called the Subinterface Configuration mode.

User EXEC Mode

The user EXEC level prompt consists of the host name followed by the angle bracket (>). For example:

```
console>
```



NOTE: The default host name is `console` unless it has been modified during initial configuration.

The user EXEC commands permit connecting to remote devices, changing terminal settings on a temporary basis, performing basic tests, and listing system information.

To list the user EXEC commands, enter a question mark at the command prompt.

Privileged EXEC Mode

Privileged access can be protected to prevent unauthorized access and ensure operating parameters. Passwords are case-sensitive, and each character of the password displays on screen as an asterisk.

To access and list the Privileged EXEC Mode commands:

1. At the prompt type `enable` and press <Enter>.
2. If a password prompt displays, enter the password and press <Enter>.

The Privileged EXEC mode prompt displays as the device host name followed by `#`. For example:

```
console#
```

3. To list the Privileged EXEC commands, type a question mark at the command prompt.
4. To return from Privileged EXEC Mode to User EXEC Mode, type the `exit` command or press <Ctrl><Z> keys.

The following example illustrates accessing privileged EXEC mode and then returning to the User EXEC mode:

```
console>enable
```

```
Enter Password: *****
```

```
console#
```

```
console#exit
```

```
console>
```

Use the `exit` command to move back to a previous mode. For example, you can move from Interface Configuration mode to Global Configuration mode, and from Global Configuration mode to Privileged EXEC mode.

Global Configuration Mode

Global Configuration commands apply to system features, rather than to a specific protocol or interface.

To access Global Configuration mode:

1. At the Privileged EXEC Mode prompt, type `configure` and press <Enter>. The Global Configuration Mode displays as the device host name, followed by (config) and the number sign #.
`console(config)#`
2. To list the Global Configuration commands, enter a question mark at the command prompt.
3. To return from Global Configuration mode to Privileged EXEC mode, type the `exit` command or use the <Ctrl><Z> command.

The following example illustrates how to access *Global Configuration Mode* and return to the *Privileged EXEC Mode*:

```
console#  
console#configure  
console (config) #exit  
console#
```

Interface Configuration Mode

Interface configuration commands modify specific IP interface settings, including bridge-group, description, and so forth. The Interface Configuration modes are:

- **VLAN** — Contains commands to create and configure a VLAN as a whole, for example, to create a VLAN and apply an IP address to the VLAN.
- **Port Channel** — Contains commands for configuring Link Aggregation Groups (LAG).
- **Ethernet** — Contains commands for managing Ethernet port configuration.
- **Loopback**—Contains commands for managing Loopback interface configuration.
- **Tunnel**—Contains commands for managing Tunnel interface configuration.

Cable and Port Information

Overview

This section describes the switch's physical interfaces and provides information about cable connections.

Stations are connected to the switch's ports through the physical interface ports on the front panel. For each station, the appropriate mode (Half-Duplex, Full-Duplex, Auto) is set.

The topics covered in this section include:

- Ethernet Interface
- SFP Interfaces
- Bay 1 and Bay 2 Interfaces
- Serial Cable Connection
- Power Connection

Ethernet Interface

The switching port can connect to stations wired in standard RJ-45 Ethernet station mode.

Figure 3-1. RJ-45 Connector

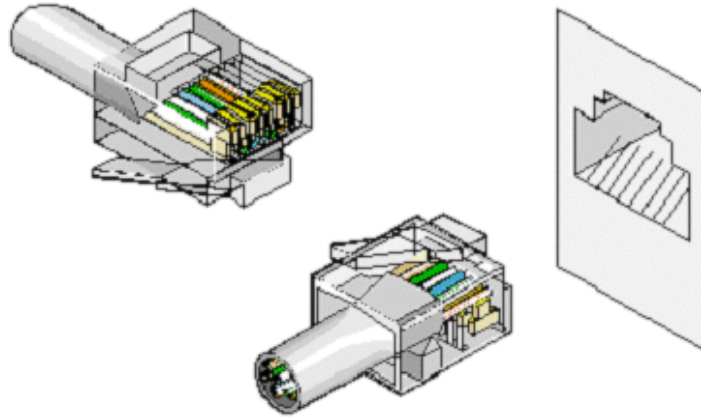

SFP Interfaces

SFP interfaces are on the console front. Figure 3-2 illustrates an SFP connector.

Figure 3-2. SFP Connector

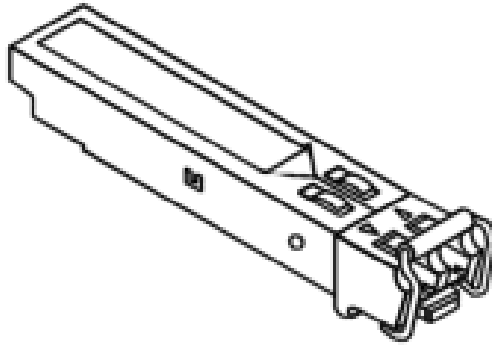

Bay 1 and Bay 2 Interfaces

The Dell™ PowerConnect™ 6200series switches support dual 10 Gb slot interfaces. These interfaces can operate at 10 Gbps when supporting optional SFP+, CX4, XFP, and 10GBase-T modules.

Figure 3-3. Bay 1 and Bay 2 PowerConnect 6200 Series 10 Gb Slots

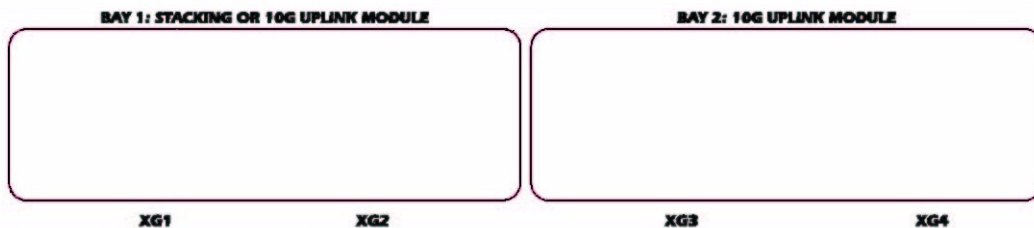

Serial Cable Connection

You can use the supplied serial cable (null-modem) to connect the switch to a terminal for initial setup and configuration (You can also use a computer running terminal emulation software). The switch's serial cable is a female to female DB-9 crossover cable.

Connecting the Switch to a Terminal

1. Connect the serial cable to the terminal (console) ASCII DTE RS-232.
2. Connect the serial cable to the switch's serial port.
3. If you are configuring a stack, connect the interface cable to the serial port of the Master switch.

Figure 3-4. Serial Connection to Switch

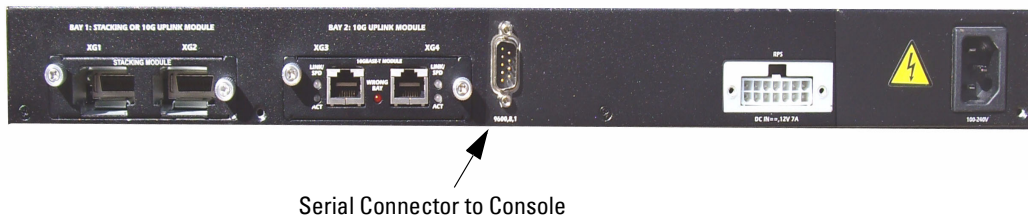

Power Connection

1. Using a 5-foot (1.5 m) standard power cable with safety ground connected, connect the power cable to the AC main socket located on the rear panel.
2. Connect the power cable to a grounded AC outlet.
3. If you are using a redundant DC power supply, such as the RPS600 or EPS470, connect the DC power cable to the DC socket located on the rear panel.
4. Confirm that the device is connected and operating correctly by examining the LEDs on the front panel.

For a complete explanation of the LEDs, see LED Definitions

Figure 3-5. AC Power Connection to PowerConnect 6200 Series

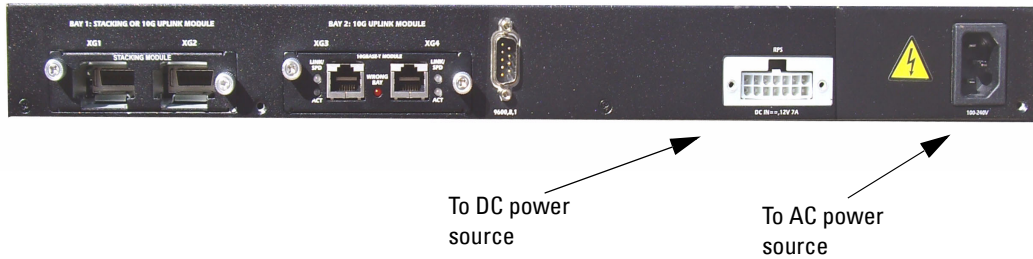

Hardware Description

Overview

This section contains information about device characteristics and modular hardware configurations for the PowerConnect 6200 Series. The topics covered in this section include:

- Front Panel
- Rear Panel
- Console (RS-232) Port
- Physical Dimensions
- Power Supplies
- Ventilation System
- Stacking
- LED Definitions

Front Panel

The PowerConnect 6224 front panels provides 24 10/100/1000M Base-T RJ-45 ports with four RJ-45/SFP combo ports that have an auto-sensing mode for speed, flow control, and duplex mode.

Figure 4-1. PowerConnect 6224 with 24 10/100/1000 Base-T Ports

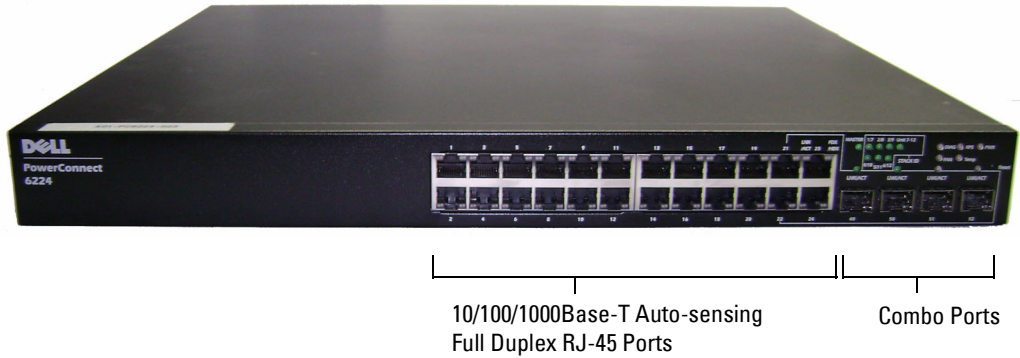

The PowerConnect 6248 front panel provides 48 10/100/1000M Base-T RJ-45 ports and four RJ-45/SFP combo ports.

Figure 4-2. PowerConnect 6248 with 48 10/100/1000M Base-T Ports

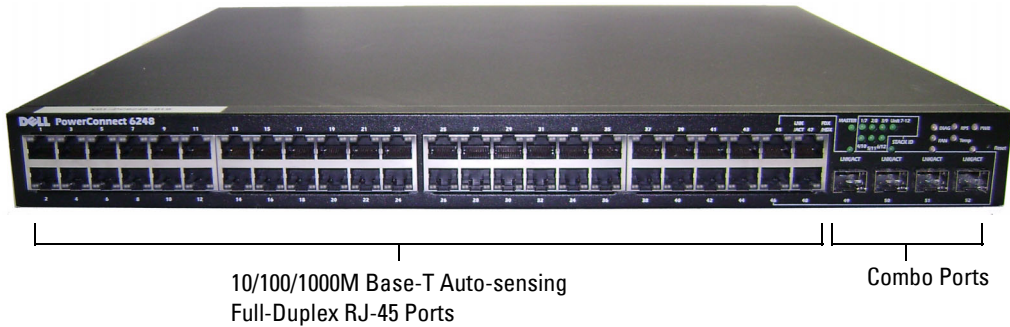

The PowerConnect 6224F front panel provides 24 10/100/1000M Base-FX SFP ports and four RJ-45/SFP combo ports.

Figure 4-3. PowerConnect 6224F with 24 SFP Ports

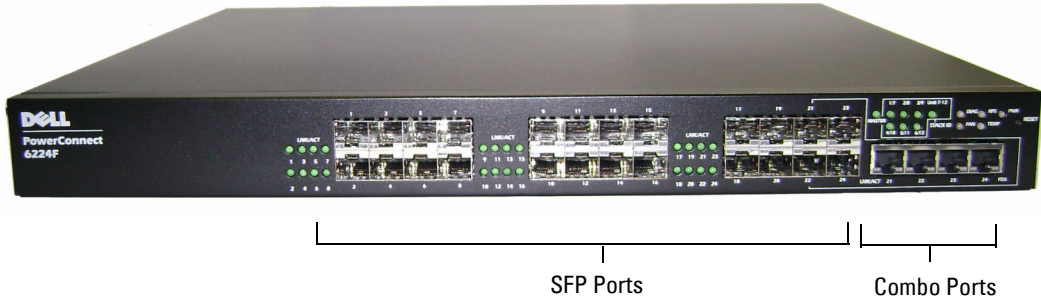

The PowerConnect 6224P front panel provides 24 10/100/1000M Base-T RJ-45 ports and four RJ-45/SFP combo ports.

Figure 4-4. PowerConnect 6224P with 24 10/100/1000 Base-T Ports



The PowerConnect 6248P front panel provides 44 10/100/1000 Base-T RJ-45 ports and four RJ-45/SFP combo ports.

Figure 4-5. PowerConnect 6248P with 48 10/100/1000 Base-T Ports

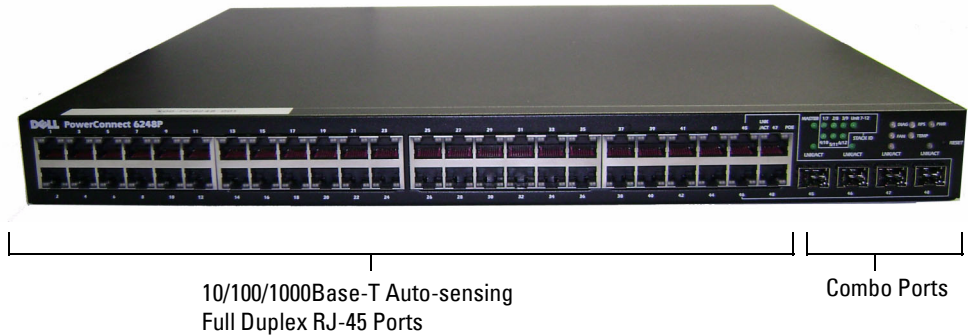

- The switch automatically detects crossed and straight-through cables on RJ-45 ports.
- RJ-45 ports support half- and full-duplex mode 10/100/1000 Mbps.
- The pinhole reset button is on the front panel.
- SFP/SFP+ ports support both SX and LX modules.

SFP/SFP+ transceivers are sold separately. Figure 4-12 shows an example 10 GE SFP+ module.

Rear Panel

Each PowerConnect 6200 series switch provides an RS-232 maintenance port, on the rear. This serial connection can be used to manage an entire stack.

Dual 10Gbps expansion slots are also mounted on the rear of the switch. The left slot (Bay 1) can support a plug-in Dual 10GbE XFP module, a CX4 module, or a stacking module. The right slot (Bay 2) can support a plug-in Dual 10GbE XFP module, a 10GBase-T module, or a CX4 module.

Figure 4-6. PowerConnect 6224, 6248, and 6224F Rear Panel

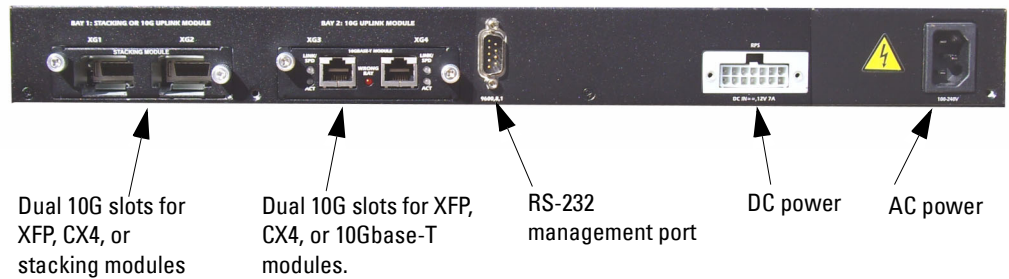

Figure 4-7. PowerConnect 6224P and 6248P Rear Panel

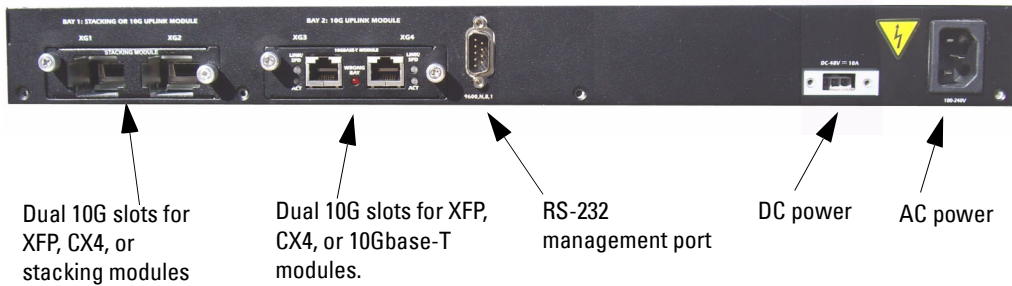

Figure 4-8. Stacking Module



Figure 4-9. XFP Module



Figure 4-10. 10 GbE CX4 Module



Figure 4-11. 10GBase-T Module





Figure 4-12. SFP+ Module



Console (RS-232) Port

The console (RS-232) port is used only for management through a serial interface. This port provides a direct connection to the switch and is used to access the CLI from a console terminal connected to an EIA/TIA-232 port.

 **NOTE:** The console port supports asynchronous data of eight data bits, one stop bit, no parity bit, and no flow control. The default baud rate is 9600 bps.

 **NOTE:** If you are installing a *stack* of switches, you need to assemble and cable the stack before powering up and configuring it. When a stack is powered up for the first time, the switches elect a Master Switch, which may occupy any location in the stack. Connect the terminal to the Master Switch. If you connect the terminal to a subordinate switch, you will not be able to use the CLI.

Physical Dimensions

The 6200 series switches have the following physical dimensions:

- 440 x 460 x 44 mm (W x D x H).
- 17.32 x 18.11 x 1.73 inch (W x D x H).

Power Supplies

The 6200 series switches have one internal power supply which requires standard AC. For non-PoE switches, you can also attach a redundant DC power supply, such as the PowerConnect RPS-600. For PoE switches, you can attach a PowerConnect EPS-470. You can verify operation by observing the LEDs. See "System LEDs" for information.

Ventilation System

Three fans cool the PowerConnect 6224. The PowerConnect 6248 has four fans. You can verify operation by observing the LEDs. See "System LEDs" on page 67 for information on the LEDs.

Stacking

You can stack up to 12 PowerConnect 6224 and/or 6248 switches, supporting up to 576 front panel ports. Create a stack by connecting adjacent units using the stacking ports on the left side of the switch rear. See Figure 4-13.

1. Connect one of the short stacking cables into either of the stacking ports of the top switch and the switch directly below it. Install a separately purchased stacking module in rear "Bay 1" of each of the switches in the stack.
2. For each switch in the stack, connect one of the short stacking cables from stacking port one on the switch to stacking port two on the next switch.
3. If necessary, use a separately purchased, long (3 meter) stacking cable to connect the switches. Repeat this process until all of the devices are connected.
4. Use the remaining stacking cable to connect the remaining free ports, one each on the top and bottom switches.

Figure 4-13. Connecting a Stack of PowerConnect 6200 Series Switches

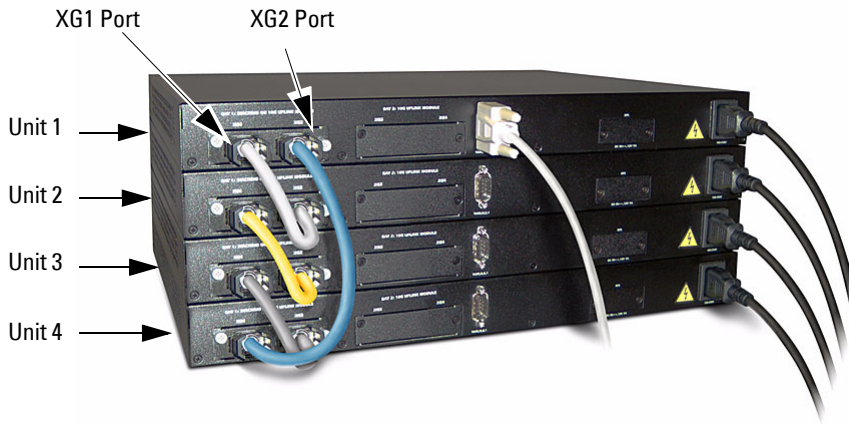

In Figure 4-13, the stack has the following physical connections between the switches:

- Unit 1 and Unit 2 are connected through the XG1 ports on each switch.
- Unit 2 and Unit 3 are connected through the XG2 ports on each switch.
- Unit 1 and Unit 4 are connected through the XG2 port on Unit 1 and the XG1 port on Unit 4.

The resulting ring topology allows the entire stack to function as a single switch with resilient fail-over capabilities.

Stacking Standby

The stacking feature supports a “Standby” or backup unit that will assume the Master unit role if the Master unit in the stack fails. As soon as a Master failure is detected in the stack, the Standby unit initializes the control plane and enables all other stack units with the current configuration. The Standby unit maintains a synchronized copy of the running configuration for the stack.

The Standby unit is preconfigured in the stack; however, you can use the CLI to select a different stack member as Standby. See the CLI Reference Guide for more information.

LED Definitions

The front panel contains light emitting diodes (LEDs) that indicate the status of links, power supplies, fans, system diagnostics, and the stack.

Figure 4-14. Front Panel LEDs

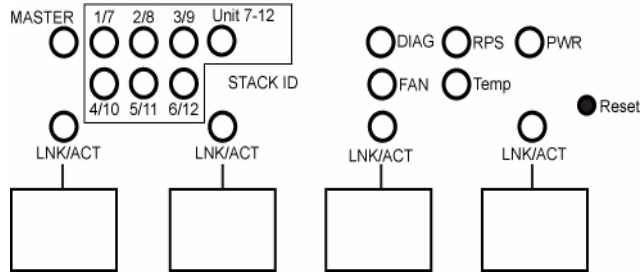

SFP Port LEDs

Figure 4-15 illustrates the SFP port LEDs that are above each SFP port.

Figure 4-15. SFP Port LEDs

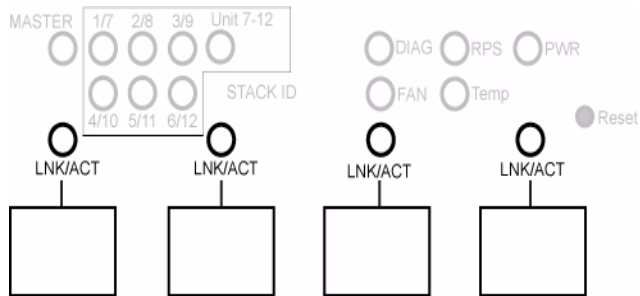

Table 4-1 contains SFP port LED definitions.

Table 4-1. SFP Port LEDs Definitions

LED	Color	Definition
LNK/ACT	Solid Green	The port is linked.
	Flashing Green	The port is sending and/or receiving network traffic.
	Off	The port is not linked.

SFP+ Port LEDs

The following table contains SFP+ port LED definitions for the PowerConnect 6200 Series switches.

Table 4-2. SFP+ Port LEDs Definitions

LED	Color	Definition
LNK/ACT	Solid Green	The port is linked.
	Flashing Green	The port is sending and/or receiving network traffic.
	Off	The port is not linked.

XFP Module Port LEDs

The XFP connectors are on the XFP module when it is inserted in the PowerConnect 6200 Series. The following table contains XFP port LED definitions.

Table 4-3. XFP Module Port LEDs Definitions

LED	Color	Definition
XFP	Green	The port is linked.
	Flashing Green	The port is sending and/or receiving network traffic.
	Off	The port is not linked.

10/100/1000 Base-T Port LEDs

Each 10/100/1000 Base-T port has two LEDs. The following figure illustrates the 10/100/100 Base-T port LEDs.

Figure 4-16. 10/100/1000 Base-T Port LEDs

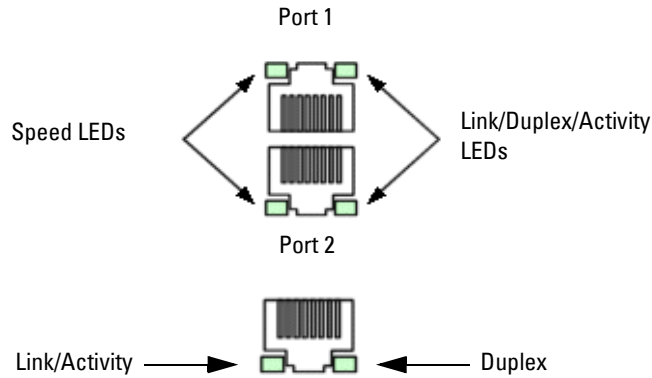

The following table contains 10/100/1000 Base-T port LED definitions.

Table 4-4. 10/100/1000 Base-T Port Definitions (6224, 6248, and 6224F)

LED	Color	Definition
Link/Activity	Green	The port is operating at 1000 Mbps.
	Amber	The port is operating at 10/100 Mbps.
	Solid	Link but no activity.
	Blinking	Link and activity.
	Off	No link.
Duplex	Green	Full-duplex mode.
	Off	Half-duplex mode.

Table 4-5 contains 10/100/1000 Base-T port LED definitions for the PowerConnect 6224P and 6248P.

Table 4-5. 10/100/1000 Base-T Port Definitions (6224P and 6248P)

LED	Color	Definition
Speed/Link/Act	Green Solid	The port is operating at 1000 Mbps.
	Green Blinking	The port is operating at 10/100 Mbps.
	Off	No link.
FDX	Green Solid	The PoE powered device is detected and is operating at normal load.

Table 4-5. 10/100/1000 Base-T Port Definitions (6224P and 6248P)

LED	Color	Definition
	Green Blinking	The port is operating at transitional mode. The PoE powered device is being detected, or is faulty.
	Amber Solid	An overload or short has occurred on the powered device.
	Amber Blinking	The powered device power conception exceeds the predefined power allotment.
	Off	No powered device is detected.

System LEDs

The system LEDs, located on the right side of the front panel, provide information about the power supplies, fans, thermal conditions, and diagnostics. Figure 4-17 illustrates the System LEDs.

Figure 4-17. System LEDs

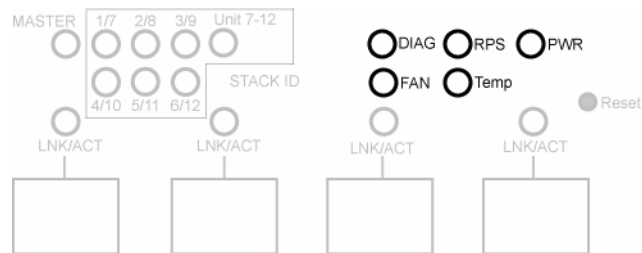

Table 4-6 contains the System LED definitions.

Table 4-6. System LED Definitions

LED	Color	Definition
DIAG	Flashing Green	A diagnostics test is in progress.
	Green	The diagnostics test was successfully completed.
	Red	The diagnostics test failed.
RPS	Green	Redundant Power Supply (RPS) is present and operating correctly.
	Red	Redundant Power Supply is present, but has failed.

Table 4-6. System LED Definitions

LED	Color	Definition
	Off	Redundant Power Supply is not present.
PWR	Green	Power Supply is operating correctly.
	Red	Power Supply has failed.
FAN	Green	Fans are operating correctly.
	Red	One or more fans have failed.
Temp	Green	System temperature is below threshold limit.
	Red	System temperature has exceeded threshold limit.

Stacking LEDs

The Stacking LEDs, located on the right side of the front panel, provide information about the location and status of the switch in the stack. Figure 4-18 illustrates the Stacking LEDs. Table 4-7 contains Stacking LED definitions.

Figure 4-18. Stacking LEDs

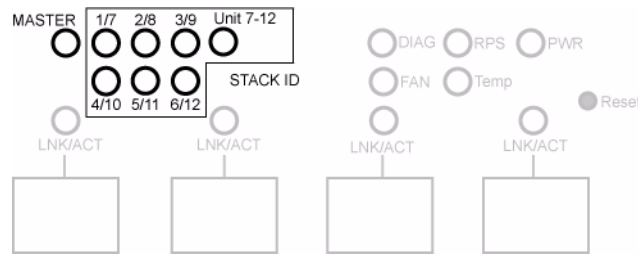

Table 4-7. Stacking LED Definitions

LED	Color	Definition
All LEDs OFF		The unit is operating as a standalone switch.
MASTER	Green	The unit is the Master Switch in the stack.
	Off	The unit is not the Master Switch in the stack.
Unit 7–12	Green	The stack ID is in the range of 7 to 12.
	Off	The stack ID is in the range of 1 to 6.
1/7	Green	The unit is the 1st or 7th switch in the stack.
	Off	The unit is not the 1st or 7th switch in the stack.
2/8	Green	The unit is the 2nd or 8th switch in the stack.

Table 4-7. Stacking LED Definitions

LED	Color	Definition
3/9	Off	The unit is not the 2nd or 8th switch in the stack.
	Green	The unit is the 3rd or 9th switch in the stack.
4/10	Off	The unit is not the 3rd or 9th switch in the stack.
	Green	The unit is the 4th or 10th switch in the stack.
5/11	Off	The unit is not the 4th or 10th switch in the stack.
	Green	The unit is the 5th or 11th switch in the stack.
6/12	Off	The unit is not the 5th or 11th switch in the stack.
	Green	The unit is the 6th or 12th switch in the stack.
	Off	The unit is not the 6th or 12th switch in the stack.

Configuring Dell PowerConnect

Overview

This chapter describes the initial switch configuration. Topics covered include:

- Starting the CLI
- General Configuration Information
- Booting the Switch
- Configuration Overview
- Advanced Configuration
- Software Download and Reboot
- Boot Menu Functions
- Sample Configuration Process

After completing all external connections, connect a terminal to the switch to monitor the boot process and other procedures.

 If you are installing a *stack* of switches, connect the terminal to the Master Switch. When a stack is powered up for the first time, the switches elect the Master Switch, which may occupy any location in the stack. This switch lights the Master Switch LED. If you connect the terminal to a subordinate switch, you will not be able to use the CLI.

Then, follow the order of installation and configuration procedures illustrated in Figure 5-1. For the initial configuration, perform the standard switch configuration. Performing other functions is described later in this section.

 **NOTE:** Before proceeding, read the release notes for this product. You can download the release notes from the Dell Support website at support.dell.com/manuals.

Starting the CLI

To begin running the CLI, perform the following steps:

 **NOTE:** The following steps are for use on the console line only.

1. Start the switch and wait until the startup procedure is complete. The **Easy Setup Wizard** welcome message now displays.
 **NOTE:** If you are using the autoconfig feature, do not use the Easy Setup Wizard.
2. Configure the switch using the **Easy Setup Wizard** and enter the necessary commands to complete the required tasks.
3. When finished, exit the session with the **quit** or **exit** command.

The switch can be managed over a direct connection to the switch console port, or through a Telnet connection. You can access the switch without a user account if you're directly connected to the switch. However, to access the switch through Telnet, at least one user account must be defined. Also, if access is through a Telnet connection, the switch must have a defined IP address, corresponding management access granted, and a workstation connected to the switch before using CLI commands.

Figure 5-1. Installation and Configuration Flow Chart

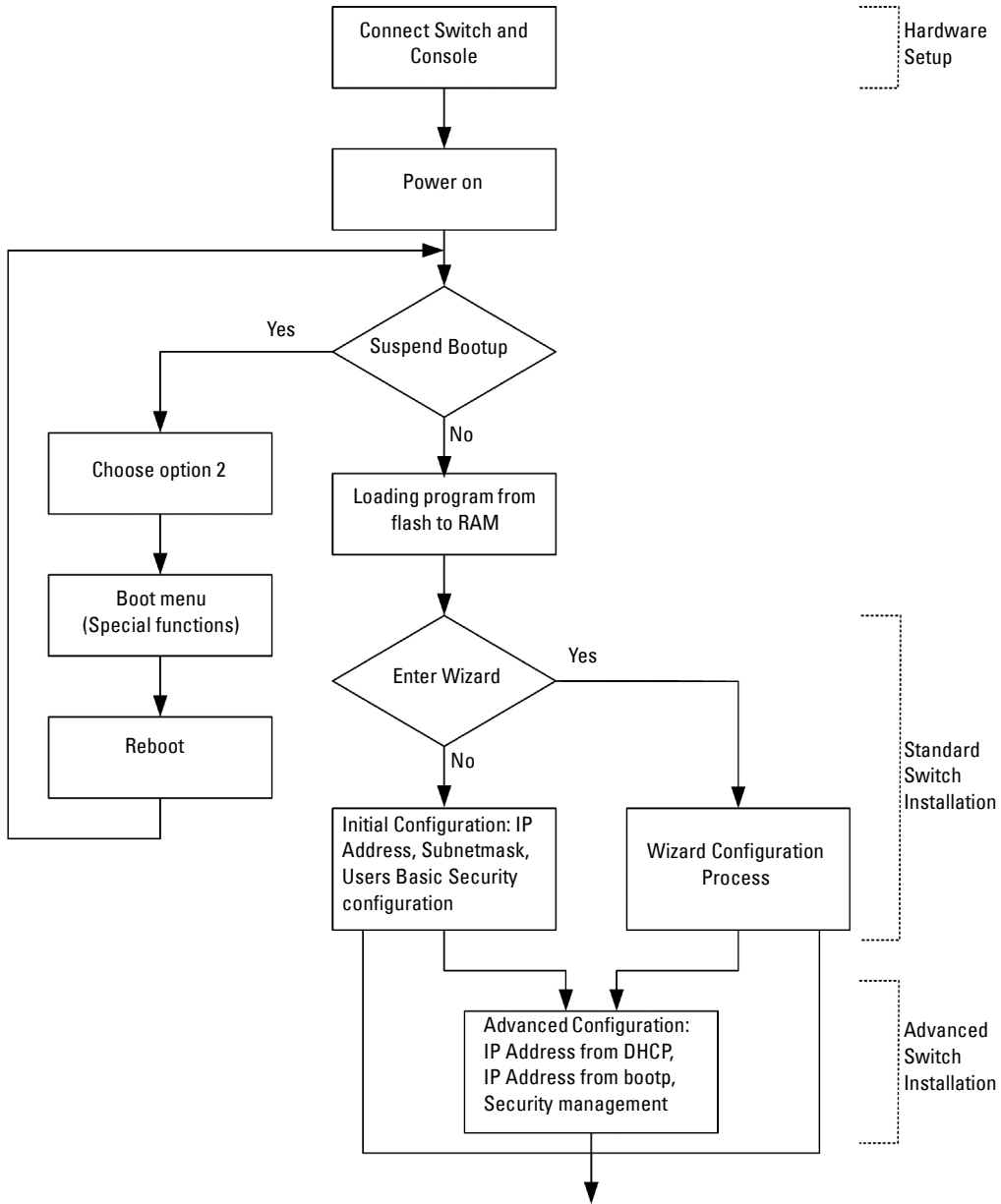

General Configuration Information

The PowerConnect 6200 Series switches are delivered with binary files containing the switch operating system and ASCII configuration files that are used to define the relationship of the switch to its network environment. The configuration process consists of adjusting the ASCII configuration files so that each switch fits into its unique network topology.

Terminal Connection Configuration

Your switch requires the following terminal connection parameters for configuration:

- no parity
- one stop bit
- 8 data bits
- no flow control

Baud Rate

The baud rates can be manually changed to any of the following values:

- 2400
- 4800
- 9600 (default baud rate)
- 19200
- 38400
- 57600
- 115200

The following is an example configuration for changing the default baud rate using CLI commands:

```
console#configure  
console (config) #line console  
console (config-line) #speed 115200
```



NOTE: Remember to set the baud rate on the terminal emulator software on your workstation to match the speed of the switch.

Other Configuration Requirements

The following is required for downloading embedded software and configuring the switch:

- ASCII terminal (or emulation) connected to the serial port (cross-cable) in the rear of the unit
- Assigned IP address for the switch for switch remote control use with Telnet, SSH, and so forth

Booting the Switch

When the power is turned on with the local terminal already connected, the switch goes through Power On Self Test (POST). POST runs every time the switch is initialized and checks hardware components to determine if the switch is fully operational before completely booting.

If a critical problem is detected, the program flow stops. If POST passes successfully, a valid executable image is loaded into RAM.

POST messages are displayed on the terminal and indicate test success or failure.

To boot the switch, perform the following steps:

1. Ensure that the serial cable is connected to the terminal.
2. Connect the power supply to the switch.
3. Turn on the switch.

As the switch boots, the boot test first counts the switch memory availability and then continues to boot.

4. During boot, you can use the **Boot** menu, if necessary to run special procedures. To enter the **Boot** menu, press **2** within the first ten seconds after the following message appears.

Select an option. If no selection in 10 seconds then operational code will start.

```
1 - Start operational code.
```

```
2 - Start Boot Menu.
```

```
Select (1, 2):2
```

For information about the **Boot** menu, see "Boot Menu Functions." The following text is an example of the entire displayed POST:

```
CPU Card ID: 0x508541
```

```
Mounting TFFS System ...
```

```
Device details...
```

```
volume descriptor ptr (pVolDesc): 0x1ae4898
```

```
XBD device block I/O handle: 0x10001
```

```
auto disk check on mount: NOT ENABLED
```

```
volume write mode: copyback (DOS_WRITE)
```

```
max # of simultaneously open files: 22
```

```
file descriptors in use:      0
# of different files in use:  0
# of descriptors for deleted files:  0
# of obsolete descriptors:    0
```

current volume configuration:

```
- volume label:      NO LABEL ; (in boot sector:      )
- volume Id:         0x0
- total number of sectors:  61,076
- bytes per sector:      512
- # of sectors per cluster: 4
- # of reserved sectors:  1
- FAT entry size:       FAT16
- # of sectors per FAT copy:  60
- # of FAT table copies:  2
- # of hidden sectors:    4
- first cluster is in sector #  136
- Update last access date for open-read-close = FALSE
- directory structure:      VFAT
- file name format:         8-bit (extended-ASCII)
- root dir start sector:      121
- # of sectors per root:      15
- max # of entries in root:    240
```

FAT handler information:

```
- allocation group size:      2 clusters
- free space on volume:       20,733,952 bytes
```

Boot Menu 3.2.0.1

Select an option. If no selection in 10 seconds then operational code will start.

1 - Start operational code.

2 - Start Boot Menu.

Select (1, 2):2

Boot Menu Version: 3.2.0.1

Options available

1 - Start operational code

2 - Change baud rate

3 - Retrieve event log using XMODEM

4 - Load new operational code using XMODEM

5 - Display operational code vital product data

6 - Abort boot code update

7 - Update boot code

8 - Delete backup image

9 - Reset the system

10 - Restore configuration to factory defaults (delete config files)

11 - Activate Backup Image

12 - Password Recovery Procedure

[Boot Menu]

The boot process runs approximately 60 seconds.

The auto-boot message that appears at the end of POST (see the last lines) indicates that no problems were encountered during boot. To return to operational code from the [Boot Menu] prompt, press 1.

The following output displays an example configuration. Items such as addresses, versions, and dates may differ for each switch.

```
Operational Code Date: Tue May 26 14:12:20 2009
```

Uncompressing.....

Target Name: vxTarget

Attached IPv4 interface to motetsec unit 0

Adding 70447 symbols for standalone.

CPU: Broadcom SBC8548. Processor #0.

Memory Size: 0x20000000. BSP version 2.0/2.

Created: May 26 2009, 13:11:31

ED&R Policy Mode: deployed

WDB Comm Type: WDB_COMM_END

WDB: Ready.

remLib: Not initialized.

remLib: Not initialized.

CFI Probe: Found 2x16 devices in x16 mode

volume descriptor ptr (pVolDesc): 0x706d770

XBD device block I/O handle: 0x10001

auto disk check on mount: NOT ENABLED

volume write mode: copyback (DOS_WRITE)

max # of simultaneously open files: 52

file descriptors in use: 0

of different files in use: 0

of descriptors for deleted files: 0

of obsolete descriptors: 0

current volume configuration:

- volume label: NO LABEL ; (in boot sector:)

- volume Id: 0x0

- total number of sectors: 124,408
- bytes per sector: 512
- # of sectors per cluster: 4
- # of reserved sectors: 1
- FAT entry size: FAT16
- # of sectors per FAT copy: 122
- # of FAT table copies: 2
- # of hidden sectors: 8
- first cluster is in sector # 260
- Update last access date for open-read-close = FALSE
- directory structure: VFAT
- file name format: 8-bit (extended-ASCII)
- root dir start sector: 245
- # of sectors per root: 15
- max # of entries in root: 240

FAT handler information:

- allocation group size: 4 clusters
- free space on volume: 44,380,160 bytes

PCI unit 0: Dev 0xb624, Rev 0x12, Chip BCM56624_B1, Driver BCM56624_B0

SOC unit 0 attached to PCI device BCM56624_B1

Adding BCM transport pointers

Configuring CPUTRANS TX

Configuring CPUTRANS RX

st_state(0) = 0x0

st_state(1) = 0x2

```
<186> JAN 01 00:00:15 0.0.0.0-1 UNKN[536870176]: bootos.c(218) 1 %  
Event(0xaaaaaaaa)
```

```
Instantiating RamCP: as rawFs, device = 0x20001
```

```
Formatting RamCP: for DOSFS
```

```
Instantiating RamCP: as rawFs, device = 0x20001
```

```
Formatting...OK.
```

```
(Unit 1 - Waiting to select management unit)>
```

```
Applying Global configuration, please wait ...
```

```
Applying Interface configuration, please wait ...
```

```
console>
```

After the switch boots successfully, a prompt appears and you can use the local terminal to begin configuring the switch. However, before configuring the switch, ensure that the software version installed on the switch is the latest version. If it is not the latest version, download and install the latest version. See "Software Download and Reboot."

Configuration Overview

Before configuring the switch, obtain the following information from the network administrator:

- Is the network setup for the autoconfig feature?
If the network is setup for autoconfig, manual configuration of the switch is not necessary (skip the procedures in this section).
- IP subnet mask for the network
- Default gateway (next hop router) IP address for configuring the default route

There are two types of configuration:

- *Initial* configuration consists of configuration functions with basic security considerations.
- *Advanced* configuration includes dynamic IP configuration and more advanced security considerations.



NOTE: After making any configuration changes, the new configuration must be saved before rebooting. To save the configuration, enter:

```
console#copy running-config startup-config
```

Easy Setup Wizard

An **Easy Setup Wizard** displays when the system boots up without a configuration or with only the default factory configuration. The **Easy Setup Wizard** is designed to guide you through some initial steps to set up basic system configuration and security and to make the switch manageable. The **Easy Setup Wizard** requires that the initial administrator account be setup when turning up the switch. This administrative account setup by the wizard has the highest privilege level (level 15).

The **Easy Setup Wizard** guides you in the basic initial configuration of a newly installed switch so that it can be immediately deployed, functional, and completely manageable through the Web, CLI, and the remote Dell Network Manager. After the initial set up, you may enter the system to set up more advanced configuration.

The system is setup with default management VLAN ID=1. The initial turn-up must be done through the serial interface.

The wizard sets up the following configuration on the switch:

- Establishes the initial privileged user account with a valid password. The wizard configures one privileged user account during the set up. The initial account is given the highest privilege level (level 15).
- Enables CLI login and HTTP/HTTPS access to use the local authentication setting only. You may return later to configure Radius or TACACS+.
- Sets up the IP address for the management VLAN.

- Sets up the SNMP community string to be used by the SNMP manager at a given IP address. You may choose to skip this step if SNMP management is not used for this switch. If it is configured, the default access level is set to the highest available access for the SNMP management interface. Initially only SNMPv1/2c is activated. SNMPv3 is disabled until you return to configure security access for SNMPv3 (for example, engine ID, view, etc.). The SNMP community string may include spaces. The wizard requires the use of quotation marks when you want to enter spaces in the community string. Although spaces are allowed in the community string, their use is discouraged. The default community string contains no spaces.
- Allows you to specify the management server IP or permit SNMP access from all IP addresses.
- Sets up the default gateway IP address.

If you do not use the wizard initially, the session defaults to the CLI mode. The set-up wizard continues to display each time you login until a configuration is saved. Once saved, the wizard option is only presented again if you reset the switch to the factory-default settings.

Since a switch may be powered on in the field without a serial connection, the switch waits 60 seconds for you to respond to a set-up prompt if the switch has not yet been configured. If there is no response, the switch continues normal operation using the default factory configuration. The next time the system reboots you are given another opportunity to run the set-up wizard.

Functional Flow

The following functional flow diagram illustrates the procedures for the **Easy Setup Wizard**.

Figure 5-2. Setup Wizard Flow Chart

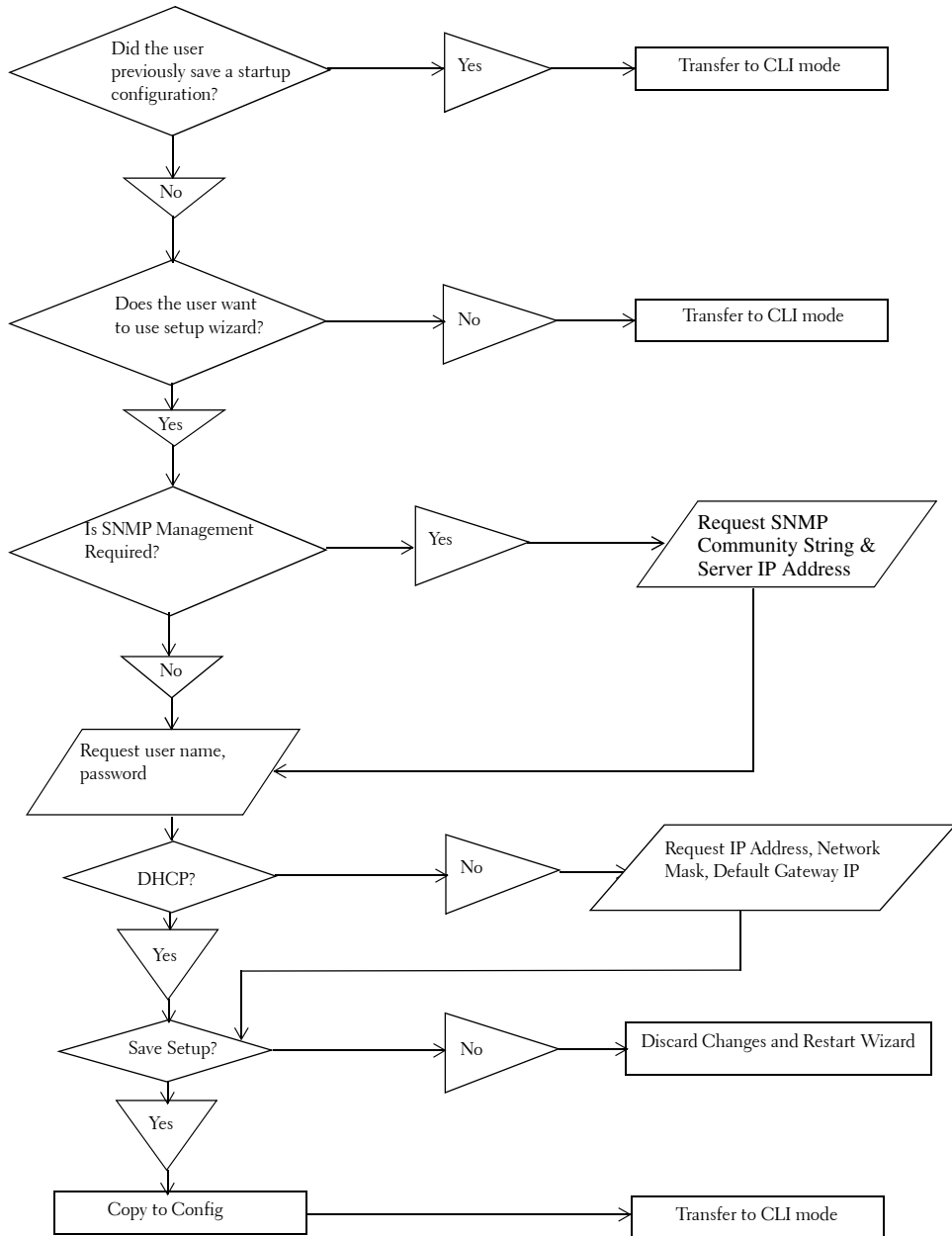

Example of an Easy Setup Wizard Session

This section describes an **Easy Setup Wizard** session. See the state diagram (Figure 5-2) for the general flow. The values used by the following session are examples only. Please request the actual values from your network administrator(s):

- IP address for the management VLAN is 192.168.2.1:255.255.255.0.
- The user name is *admin*, and password is *password*.
- The network management system IP address is 192.168.2.1.
- The default gateway is 192.168.1.1.
- The SNMP community string to be used is *public*

The setup wizard configures the initial values as defined above. After you complete the wizard, the system is configured as follows:

- SNMPv1/2c is enabled and the community string is set up as defined above. SNMPv3 is disabled.
- The admin user account is set up as defined.
- A network management system is configured. From this management station, you can access the SNMP, HTTP, and CLI interfaces. You may also choose to allow all IP addresses to access these management interfaces by choosing the (0.0.0.0) IP address.
- An IP address is configured for the default management VLAN (1).
- A default gateway address is configured.



NOTE: In the example below, the possible user options are enclosed in []. Also, where possible, the default value is provided in { }. If you enter <Return> with no options defined, the default value is accepted. Help text is in parentheses.

The following example contains the sequence of prompts and responses associated with running an example Dell **Easy Setup Wizard** session, using the input values listed above.

```
Unit 1 - Waiting to select management unit)>
```

```
Applying Global configuration, please wait ...
```

```
Welcome to Dell Easy Setup Wizard
```

```
The Setup Wizard guides you through the initial switch configuration, and gets you up and running as quickly as possible. You can skip the setup wizard, and enter CLI mode to manually configure the switch. You must respond to the next question to run the setup wizard within 60 seconds, otherwise the system will continue with normal operation using the default system configuration. Note: You can exit the setup wizard at any point by entering [ctrl+z].
```

```
Would you like to run the setup wizard (you must answer this question within 60 seconds)? [Y/N] y
```

```
Step 1:
```

The system is not setup for SNMP management by default. To manage the switch using SNMP (required for Dell Network Manager) you can:

- o Set up the initial SNMP version 2 account now.
- o Return later and setup other SNMP accounts. (For more information on setting up an SNMP version 1 or 3 account, see the user documentation).

Would you like to setup the SNMP management interface now? [Y/N] y

To setup the SNMP management account you must specify the management system IP address and the "community string" or password that the particular management system uses to access the switch. The wizard automatically assigns the highest access level [Privilege Level 15] to this account. You can use Dell Network Manager or other management interfaces to change this setting, and to add additional management system later. For more information on adding management systems, see the user documentation.

To add a management station:

Please enter the SNMP community string to be used.

{public}:

public<Enter>

Please enter the IP address of the Management System (A.B.C.D) or wildcard (0.0.0.0) to manage from any Management Station.

{0.0.0.0}:

192.168.2.1<Enter>

Step 2:

Now we need to setup your initial privilege (Level 15) user account. This account is used to login to the CLI and Web interface. You may setup other accounts and change privilege levels later. For more information on setting up user accounts and changing privilege levels, see the user documentation.

To setup a user account:

Please enter the user name: admin<Enter>

Please enter the user password: *****<Enter>

Please reenter the user password: *****<Enter>

Step 3:

Next, an IP address is setup. The IP address is defined on the default VLAN (VLAN #1), of which all ports are members. This is the IP address you use to access the CLI, Web interface, or SNMP interface for the switch.

Optionally you may request that the system automatically retrieve an IP address from the network via DHCP (this requires that you have a DHCP server running on the network).

To setup an IP address:

Please enter the IP address of the device (A.B.C.D) or enter "DHCP" (without the quotes) to automatically request an IP address from the network DHCP server.

192.168.2.1<Enter>

Please enter the IP subnet mask (A.B.C.D or /nn):

255.255.255.0<Enter>

Step 4:

Finally, set up the gateway. Please enter the IP address of the gateway from which this network is reachable

192.168.1.1<Enter>

This is the configuration information that has been collected:

SNMP Interface = "public"@192.168.2.1

User Account setup = admin

Password = *****

Management IP address = 192.168.2.1 255.255.255.0

Gateway = 192.168.1.1

Step 5:

If the information is correct, please select (Y) to save the configuration, and copy to the start-up configuration file. If the information is incorrect, select (N) to discard configuration and restart the wizard: [Y/N]

y<Enter>

Thank you for using the Dell Easy Setup Wizard. You will now enter CLI mode.

.....

console>

Advanced Configuration

CLI Basics

The `help` command in the User EXEC mode and privileged EXEC mode displays the keyboard short cuts. Following is the sample display of the help command:

```
Console>help
```

```
HELP:
```

```
Special keys:
```

```
DEL, BS .... delete previous character
Ctrl-A .... go to beginning of line
Ctrl-E .... go to end of line
Ctrl-F .... go forward one character
Ctrl-B .... go backward one character
Ctrl-D .... delete current character
Ctrl-U, X .. delete to beginning of line
Ctrl-K .... delete to end of line
Ctrl-W .... delete previous word
Ctrl-T .... transpose previous character
Ctrl-P .... go to previous line in history buffer
Ctrl-R .... rewrites or pastes the line
Ctrl-N .... go to next line in history buffer
Ctrl-Y .... print last deleted character
Ctrl-Z .... return to root command prompt
Ctrl-Q .... enables serial flow
Ctrl-S .... disables serial flow
Tab, <SPACE> command-line completion
Exit .... go to next lower command prompt
? .... list choices
```

Context Sensitive Help

Use the ? command to get context sensitive help in the CLI. It can be used to get the list of possible sub-commands or to list possible commands starting with some partially entered commands. The ? command when specified on an empty line provides the list of commands possible for the given level in the command tree. The ? can also be used within a command input to return the list of parameters that are required to fully complete the command. Parameters that are already provided by the user is left out of the command list so that only the missing parameters are listed.

Interface Naming Convention

In an industry-standard CLI implementation, there is an accepted convention for naming interfaces on the CLI. The convention for naming interfaces on Dell devices are as follows:

- **Unit#/Interface ID** — each interface is identified by the *Unit#* followed by a /symbol and then the *Interface ID* (see below). For example, 2/g10 identifies gigabit port 10 within the second unit of a stack.
- **Unit#** — the unit number is used only in a stacking solution where a number of switches are stacked to form a virtual device. In this case, the *unit number* identifies the physical device identifier within the stack.
- **Interface ID** — is formed by the interface type followed by the interface number. There is currently a predefined list of *interface types* (see below). If additional interface types are to be defined, they must be registered with Dell. For example, 1/xg10 identifies the 10-gigabit port 10 on the first unit.
- **Interface Types** — the following interface types are defined in the switches:
 - xg — 10 Gb Ethernet port (for example, 1/xg2 is the 10 Gb Ethernet port 2).

6200 Series CLI Reference Guide

For detailed information on all the CLI commands available, see the *CLI Reference Guide*.

This section provides summary information about such common tasks as:

- Modifying Switching Port Default Settings
- Retrieving an IP Address From a DHCP Server
- Configuring an Initial Console Password
- Configuring an Initial Telnet Password
- Configuring an Initial HTTP Password
- Configuring an Initial HTTPS Password

Modifying Switching Port Default Settings

When configuring/receiving IP addresses through DHCP and BOOTP, the configuration received from these servers includes the IP address, and may include subnet mask and default gateway.

When you first log in, the CLI enters the root of the command hierarchy. To go to a different level of the command hierarchy, enter commands such as **configure**, which causes the CLI to enter the *config* sub tree. To go back to the previous level in the command hierarchy, use the exit command.

```
SwitchA#configure
SwitchA (config) #exit
SwitchA#
```

The following examples show the system prompts used by the PowerConnect 6200 Series switches:

- **SwitchA>** — indicates that the host name is *SwitchA* and the CLI in the *User EXEC mode*.
- **SwitchA#** — this prompt is similar to the above prompt except that the **#** indicates that the CLI is in a privileged EXEC mode (not in the User EXEC mode).
- **SwitchA(config)#** — indicates that the CLI is currently in the *global configuration* mode of the command hierarchy. Enter this mode by typing **configure** at the privileged EXEC mode.
- **SwitchA(config-if)#** — this prompt indicates that the CLI is currently in the *interface* configuration mode. Enter this by typing **interface range ethernet**, **interface range port-channel**, or **interface range vlan** from the global configuration mode. In this case, there is no specific reference to an interface so the system is operating on a generic set of interfaces.
- **SwitchA(config-if-1/xg1)#** — indicates that the CLI is in interface configuration mode for the 10 gigabit Ethernet interface 1.

Switching Port Default Settings

The following table describes the switch port default settings.

Table 5-1. Port Default Settings

Function	Default Setting
Port speed and mode	1G Auto-negotiation
Port forwarding state	Enabled
Head of line blocking prevention	On (Enabled)
Flow Control	On
Back Pressure	Off

The following is an example for changing the port description on port 1/g1 using CLI commands:

```
console (config) #interface ethernet 1/g1
console (config-if-1/g1) #description 100
```

Retrieving an IP Address From a DHCP Server

When using the DHCP protocol to retrieve an IP address, the switch acts as a DHCP client.

To retrieve an IP address from a DHCP server, perform the following steps:

1. Select and connect any port to a DHCP server or to a subnet that has a DHCP server on it, in order to retrieve the IP address.



NOTE: You do not need to delete the switch configuration to retrieve an IP address for the DHCP server.

2. Enter the following commands to use the selected port for receiving the IP address.

- Assigning Dynamic IP Addresses for the management interface:

```
console#config
console (config) #ip address dhcp
```

The interface receives the IP address automatically.

3. To verify the IP address, enter the **show ip interface** command at the system prompt as shown in the following examples.

```
console#show ip interface
Management Interface:
IP Address..... 10.240.4.125
Subnet Mask..... 255.255.255.0
Default Gateway..... 10.240.4.1
Burned In MAC Address..... 00:10:18:82:04:35
Network Configuration Protocol Current..... DHCP
Management VLAN ID..... 1
Routing Interfaces:
Netdir Multi
```

Interface	IP Address	IP Mask	Bcast	CastFwd
vlan1	192.168.10.10	255.255.255.0	Disable	Disable
vlan2	0.0.0.0	0.0.0.0	Enable	Disable
loopback2	0.0.0.0	0.0.0.0	Disable	Disable

Review Copy

Security Management and Password Configuration

System security is handled through the AAA (Authentication, Authorization, and Accounting) mechanism that manages user access rights, privileges, and management methods. AAA uses both local and remote user databases. Data encryption is handled through the SSH mechanism.

The system is delivered with no default password configured; all passwords are user-defined. If a user-defined password is lost, a password recovery procedure can be invoked from the **Boot** menu. The procedure is applicable for the local terminal only and allows a one-time access to the switch from the local terminal with no password entered.

Configuring Security Passwords

The security passwords can be configured for the following services:

- Console
- Telnet
- SSH
- HTTP
- HTTPS



NOTE: When creating a user name, the default priority is 1, which allows access but not configuration rights. A priority of 15 must be set to enable access and configuration rights to the switch.

Configuring an Initial Console Password

To configure an initial console password, enter the following commands:

```
console (config) #aaa authentication login default line
console (config) #aaa authentication enable default line
console (config) #line console
console (config-line) #login authentication default
console (config-line) #enable authentication default
console (config-line) #password secret123
```

- When initially logging on to a switch through a console session, enter **secret123** at the password prompt.
- When changing a switch's mode to enable, enter **secret123** at the password prompt.

Configuring an Initial Telnet Password

To configure an initial Telnet password, enter the following commands:

```
console (config) #aaa authentication login networkList line
console (config) #aaa authentication enable networkList line
console (config) #line telnet
console (config-line) #login authentication networkList
console (config-line) #enable authentication networkList
console (config-line) #password pass1234
```

- When initially logging onto a switch through a Telnet session, enter **pass1234** at the password prompt.
- When changing a switch mode to enable, enter **pass1234**.

Configuring an Initial HTTP Password

To configure an initial HTTP password, enter the following commands:

```
console (config) #ip http authentication local
console (config) #username admin password user1234 level 15
```



Configuring an Initial HTTPS Password

To configure an initial HTTPS password, enter the following commands:

```
console (config) #ip https authentication local
```

 **NOTE:** You should generate a new crypto certificate each time you upgrade (install a new version of) the control software application on the switch.

Enter the following commands once when configuring to use an HTTPS session over a console, a Telnet, or an SSH session.

 **NOTE:** In the Web browser enable SSL 2.0 or greater for the page content to appear.

```
console#configure
```

```
console (config) #crypto certificate 1 generate
```

```
console (config-crypto-cert) #country US
```

```
console (config-crypto-cert) #email support@broadcom.com
```

```
console (config-crypto-cert) #location Morrisville
```

```
console (config-crypto-cert) #organization-name NWSOFT
```

```
console (config-crypto-cert) #organization-unit CustOp
```

```
console (config-crypto-cert) #state NC
```

```
console (config-crypto-cert) #key-generate
```

```
console (config-crypto-cert) #exit
```

```
console (config) #
```

 **NOTE:** HTTP and HTTPS services require level 15 access and connect directly to the configuration level access.

Software Download and Reboot

Software Download Through XModem

This section contains instructions for downloading switch software (system and boot images) using XModem, which is a data transfer protocol for updating back-up configuration files.

 **NOTE:** You must be connected to the serial console interface when doing this because xmodem download won't work elsewhere.

To download a software image file using XModem:

Specify the source file path to begin the transfer process.

The following is an example of the information that appears:

```
console#copy xmodem image
Mode..... XMODEM
Data Type..... Code
Destination Filename..... image2
```

Management access will be blocked for the duration of the transfer

Are you sure you want to start? (y/n) **y**

```
console#boot system image2
```

Software Download Through TFTP Server

This section contains instructions for downloading switch software (system and boot images) through a TFTP server. The TFTP server must be available on the network before downloading the software.

The switch boots and runs when decompressing the system image from the flash memory area where a copy of the system image is stored.

 **NOTE:** You must run the **boot system** command to activate the newly downloaded image.

On the next boot, the switch decompresses and runs the currently active system image unless chosen otherwise.

To download an image through the TFTP server:

1. Ensure that an IP address is configured on and pings can be sent to a TFTP server.
2. Ensure that the file to be downloaded is saved on the TFTP server (the **.stk** file).
3. Enter the command **show version** to verify which software version is currently running on the switch.

The following is an example of the information that appears:

```
console>show version
```

```
Image Descriptions
```

```
image1 : default image
```

```
image2 :
```

```
Images currently available on Flash
```

```
-----  
unit      image1      image2      current-active      next-active  
-----  
1  7.10.19.22  7.16.23.35      image2              image2
```

4. Enter the command **copy tftp://{tftp address}/{file name} image** to copy a new system image to the switch.

When the new image is downloaded, it is saved in the area allocated for the other copy of system image (image2, as given in the example). The following is an example of the information that appears:

```
console#copy tftp://10.254.24.64/pc62xxr0v34.stk image
```

```
Mode..... TFTP
```

```
Set TFTP Server IP..... 10.254.24.64
```

```
TFTP Path..... ./
```

```
TFTP Filename..... PC6224v3.2.1.0.stk
```

```
Data Type..... Code
```

```
Destination Filename..... image
```

Management access will be blocked for the duration of the transfer

Are you sure you want to start? (y/n) **y**

5. Select the image for the next boot by entering the **boot system image2** command. After this command, enter the command **show version** to verify that the copy indicated as a parameter in the **boot system** command is selected for the next boot.

The following is an example of the information that appears:

```
console#boot system image2
```

```
Activating image image2 ..
```

```
console>show version
```

```
Image Descriptions
```

```
image1 : default image
```

```
image2 :
```

```
Images currently available on Flash
```

```
-----  
unit   image1   image2   current-active   next-active  
-----  
1      3.2.1.0   3.2.1.1   image1           image2
```

If the image for the next boot is not selected by entering the **boot system** command, the system boots from the currently active image (image1, as given in the example).

6. Enter the command **reload**. The following message displays:

```
console#reload
```

```
Management switch has unsaved changes.
```

```
Are you sure you want to continue? (y/n)
```

7. Enter y. The following message then displays.

```
Configuration Not Saved!
```

```
Are you sure you want to reload the stack? (y/n)
```

8. Enter y to reboot the switch.

Update Bootcode

Use the **update bootcode** command to update the bootcode on all switches. For each switch, the bootcode is extracted from the next-active image and programmed to flash. To update the bootcode for one switch, specify the unit in the command (as shown in the following example).

To show the boot code that's on a switch, use the **show boot-version** command. The version number shows during the boot process.

1. Enter the following command:

```
console#update bootcode
Update bootcode and reset (Y/N)?
```

2. Enter y to reboot the switch.

Boot Menu Functions

You can perform many configuration tasks through the **Boot** menu, which can be invoked after the first part of the POST is completed.

To display the **Boot** menu, during the boot process, press **2** within ten seconds after the following message displays:

```
Boot Menu Version: 3.2.0.1
Select an option. If no selection in 10 seconds then
operational code will start.
```

1 - Start operational code.

2 - Start Boot Menu.

Select (1, 2):

The **Boot** menu displays and contains the following configuration functions:

- 1 - Start operational code
- 2 - Change baud rate
- 3 - Retrieve event log using XMODEM
- 4 - Load new operational code using XMODEM
- 5 - Display operational code vital product data
- 6 - Abort boot code update
- 7 - Update boot code
- 8 - Delete backup image
- 9 - Reset the system
- 10 - Restore configuration to factory defaults (delete config files)
- 11 - Activate Backup Image
- 12 - Password Recovery Procedure
- 13 - Reformat and restore file system

The following sections describe the **Boot** menu options.

Start Operational Code

Use option 1 to resume loading the operational code.

To relaunch the boot process from the **Boot** menu, select **1** on the **Boot** menu and press <Enter>.

The following prompt displays:

Operational Code Date: Tue Apr 29 10:15:36 2008

Uncompressing.....

50%

100%

|||||

Change the Baud Rate

Use option **2** to change the baud rate of the serial interface.

To change the baud rate from the **Boot** menu:

1. On the **Boot** menu, select **2** and press <Enter>.

The following prompt displays:

```
[Boot Menu] 2
```

```
Select baud rate:
```

```
1 - 1200
```

```
2 - 2400
```

```
3 - 4800
```

```
4 - 9600
```

```
5 - 19200
```

```
6 - 38400
```

```
7 - 57600
```

```
8 - 115200
```

```
0 - no change
```



NOTE: The selected baud rate takes effect immediately.

2. The boot process resumes.

Retrieve Event Log using XMODEM

Use option **3** to retrieve the event log and download it to your ASCII terminal.

To retrieve the event log from the **Boot** menu:

1. On the **Boot** menu, select **3** and press <Enter>.

The following prompt displays:

```
[Boot Menu] 3
```

```
Sending event log, start XMODEM receive.....
```

```
File ascii-log.bin Ready to SEND in binary mode
```

```
Estimated File Size 169K, 1345 Sectors, 172032 Bytes
```

```
Estimated transmission time 3 minutes 20 seconds
```

```
Send several Control-X characters to cancel before transfer starts.
```

2. The boot process resumes.

Load New Operational Code Using XMODEM

Use option 4 when a new software version must be downloaded to replace corrupted files, update, or upgrade the system software.

To download software from the **Boot** menu:

1. On the **Boot** menu, select **4** and press <Enter>.

The following prompt displays:

```
[Boot Menu] 4
Ready to receive the file with XMODEM/CRC....
Ready to RECEIVE File xcode.bin in binary mode
Send several Control-X characters to cancel before transfer starts.
```

2. When using HyperTerminal, click **Transfer** on the **HyperTerminal** menu bar.
3. From the **Transfer** menu, click **Send File**.

The **Send File** window displays.

4. Enter the file path for the file to be downloaded.
5. Ensure the protocol is defined as Xmodem.
6. Click **Send**.

The software is downloaded. Software downloading takes several minutes. The terminal emulation application, such as HyperTerminal, may display the loading process progress.

Display Operational Code Vital Product Data

Use option 5 to view boot image information.

To display boot image information from the **Boot** menu:

1. On the **Boot** menu, select **5** and press <Enter>.

The following prompt displays:

```
[Boot Menu] 5
The following image is in the Flash File System:
File Name.....image1
CRC.....0xb017 (45079)
Target Device.....0x00508541
Size.....0x8ec50c (9356556)
Number of Components.....2
Operational Code Size.....0x7ec048 (8306760)
```



```

Operational Code Offset.....0x74 (116)
Operational Code FLASH flag.....1
Operational Code CRC.....0x9B4D
Boot Code Version.....1
Boot Code Size.....0x10000 (1048576)
Boot Code Offset.....0x7ec0bc (8306876)
Boot Code FLASH flag.....0
Boot Code CRC.....0x1CB8
VPD - rel 3 ver 1 maint_lvl 0 build_num 4
      Timestamp - Thu Jun  8 12:51:44 2009
      File - pc62xxr0v3.2.1.0.stk

```

2. The boot process resumes.

Abort Boot Code Update

Use option 6 to abort a boot code update initiated by the user. A user can initiate a boot code update by selecting option 7 on the boot menu or by entering a CLI command. This sets a flag and causes the system to reboot. When the boot code starts, the system reads the flag and determines that a boot code update has been requested, and pauses for user response. The boot code update proceeds if there is no user response within 10 seconds. During that interval, the user can enter the boot menu and select option 6 to cancel the boot code update and continue rebooting.

Update Boot Code

Use option 7 to update the boot code in the flash memory. This option is only valid after loading new boot code using Boot Menu option 4. User action is confirmed with a Y/N question before executing the command.

To download software from the **Boot** menu:

1. On the **Boot** menu, select 7 and press <Enter>.

The following prompt displays:

```

Do you wish to update Boot Code? (y/n) y
Validating image2....OK
Extracting boot code from image...CRC valid
Erasing Boot Flash.....Done.
Wrote 0x10000 bytes.

```

```
Wrote 0x20000 bytes.  
Wrote 0x30000 bytes.  
Wrote 0x40000 bytes.  
Wrote 0x50000 bytes.  
Wrote 0x60000 bytes.  
Wrote 0x70000 bytes.  
Wrote 0x80000 bytes.  
Wrote 0x90000 bytes.  
Wrote 0xa0000 bytes.  
Wrote 0xb0000 bytes.  
Wrote 0xc0000 bytes.  
Wrote 0xd0000 bytes.  
Wrote 0xe0000 bytes.  
Wrote 0xf0000 bytes.  
Wrote 0x100000 bytes.  
Validating Flash.....Passed  
Flash update completed.
```

2. The boot process resumes.

Delete Backup Image

Use option 8 to delete the backup image from the flash memory. User action is confirmed with a Y/N question before executing the command.

To delete the backup image from the **Boot** menu:

1. On the **Boot** menu, select **8** and press <Enter>.

The following prompt displays:

```
Are you SURE you want to delete backup image : image2 ? (y/n):y
```

```
Backup image deleted...
```

```
[Boot Menu]
```

2. The boot process resumes.

Reset the System

Use option 9 to reboot and reset the system to its default setting. User action is confirmed with a Y/N question before executing the command.

To reset the system from the **Boot** menu:

1. On the **Boot** menu, select **9** and press <Enter>.

The following prompt displays:

```
[Boot Menu] 9
```

```
Are you SURE you want to reset the system? (y/n):y
```

2. The boot process starts over.

Restore Configuration to Factory Defaults

Use option 10 to load using the system default configuration and to boot without using the current startup configuration. Selecting 10 from the Boot Menu restores system defaults and deletes the configuration files. Boot Sequence can then be started by selecting 1 from the Boot Menu.

To download software from the **Boot** menu:

1. On the **Boot** menu, select **10** and press <Enter>.

The following prompt displays:

```
Are you SURE you want to delete the configuration? (y/n):y
```

2. The boot process resumes.

Activate Backup Image

Use option 11 to activate the backup image. The active image becomes the backup when this option is selected.

To activate the backup image:

1. From the **Boot** menu, select **11** and press <Enter>.

The following message displays:

```
Backup image - image2 activated.
```

2. The boot process resumes.

Password Recovery Procedure

Use option 12 when a password is lost. This allows the switch to boot one time without prompting for a console password. Note that the *enable* password is not prompted for in this mode.

To recover a lost password for the local terminal only:

1. From the **Boot** menu, select **12** and press <Enter>. The password is deleted.
2. The boot process resumes.
3. To ensure switch security, reconfigure passwords for applicable management methods.

Reformat and Restore File System

Use option 13 to format the flash file system if file corruption is observed. Certain critical files are copied from flash to RAM, the flash file system is invalidated and formatted. Then, the files are copied from RAM back to flash and the switch is rebooted. The following files are copied:

- image1
- image2
- startup-config
- vpd.bin
- hpc_broad.cfg
- boot.dim

1. From the **Boot** menu, select **13** and press <Enter>.

The following messages display as the file system in RAM is formatted:

```
Instantiating /RamDisk/ as rawFs, device = 0x20001
Formatting /RamDisk/ for DOSFS
Instantiating /RamDisk/ as rawFs, device = 0x20001
Formatting.../RamDisk/: file system is marked clean, skipping check
OK.
```

Then, the file system is copied from flash memory to RAM:

```
copying file /DskVol/files/image1 -> /RamDisk/image1
copying file /DskVol/files/image2 -> /RamDisk/image2
copying file /DskVol/files/startup-config -> /RamDisk/startup-config
...
```

2. The system reboots.

Sample Configuration Process

This section provides the basic steps required to establish a remote network management connection with the switch. This section does not explain the various configurations available on the switch or the relevant commands.

This section also describes accessing a switch for the first time with the default configuration and definitions. If a previously entered configuration causes problems, the startup-configuration file — which is the configuration of switch when powered up — should be erased and the switch rebooted. See "Device Default Settings."

Switch Setup Requirements

The following components are required for the purpose of this example:

- PowerConnect 6200 Series switch
- A workstation with the following components installed:
 - Network adapter card
 - ASCII terminal application (for example, Microsoft® Windows® HyperTerminal or Procomm Plus™ Terminal)
 - A browser application
- One Null Modem F2F cable
- Straight or cross UTP (category 5) cable(s)

Initial Connection

1. Using the RS-232 port, connect the switch to the workstation.
2. Set the serial console with the following settings and select the appropriate COM port.
The sample screen uses the HyperTerminal.

Figure 5-3. HyperTerminal Properties Window

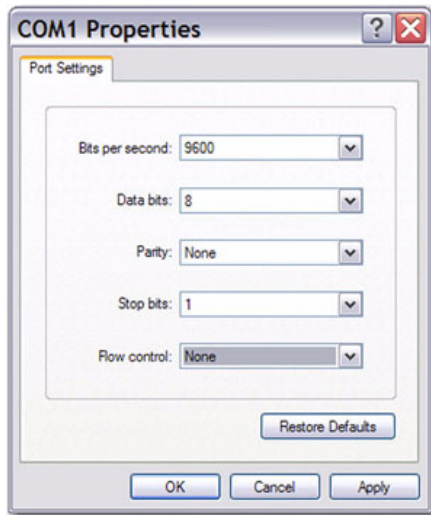

 **NOTE:** 9600 is the default baud rate for a new switch. The switch may have another baud rate. If using the default baud rate does not result in viewing the switch terminal, try another baud rate.

3. Use F2F null modem cable to connect the workstation to the switch.

 If you are configuring a *stack*, connect the workstation to the Master Switch.

4. Connect the switch power cord and power up the switch. The system begins the boot process. When the following displays, you can enter the **Boot** menu by selecting 2, if necessary, to run special procedures.

Select an option. If no selection in 10 seconds then operational code will start.

1 - Start operational code.

2 - Start Boot Menu.

Select (1, 2):2

If you do not enter the **Boot** menu, the system continues operation by decompressing the code into RAM. The code starts running from the RAM and the list of available port numbers and their states (up or down) are displayed.

 **NOTE:** The following screen is an example configuration. Items such as addresses, versions, and dates may differ for each switch.

current volume configuration:

- volume label: NO LABEL ; (in boot sector:)
- volume Id: 0x0
- total number of sectors: 124,408
- bytes per sector: 512
- # of sectors per cluster: 4
- # of reserved sectors: 1
- FAT entry size: FAT16
- # of sectors per FAT copy: 122
- # of FAT table copies: 2
- # of hidden sectors: 8
- first cluster is in sector # 260
- Update last access date for open-read-close = FALSE
- directory structure: VFAT
- file name format: 8-bit (extended-ASCII)
- root dir start sector: 245
- # of sectors per root: 15
- max # of entries in root: 240

FAT handler information:

- allocation group size: 4 clusters
- free space on volume: 44,380,160 bytes

Boot Menu Version: 3.2.0.1

Select an option. If no selection in 10 seconds then operational code will start.

1 - Start operational code.

2 - Start Boot Menu.

Select (1, 2):

Operational Code Date: Tue May 26 14:12:20 2009

Uncompressing.....

Target Name: vxTarget

Attached IPv4 interface to motetsec unit 0

Adding 70447 symbols for standalone.

CPU: Broadcom SBC8548. Processor #0.

Memory Size: 0x20000000. BSP version 2.0/2.

Created: May 26 2009, 13:11:31

ED&R Policy Mode: deployed

WDB Comm Type: WDB_COMM_END

WDB: Ready.

remLib: Not initialized.

remLib: Not initialized.

CFI Probe: Found 2x16 devices in x16 mode

volume descriptor ptr (pVolDesc): 0x706d770

XBD device block I/O handle: 0x10001

auto disk check on mount: NOT ENABLED

volume write mode: copyback (DOS_WRITE)

max # of simultaneously open files: 52

file descriptors in use: 0

of different files in use: 0

of descriptors for deleted files: 0

of obsolete descriptors: 0

current volume configuration:

- volume label: NO LABEL ; (in boot sector:)
- volume Id: 0x0
- total number of sectors: 124,408
- bytes per sector: 512
- # of sectors per cluster: 4
- # of reserved sectors: 1
- FAT entry size: FAT16
- # of sectors per FAT copy: 122
- # of FAT table copies: 2
- # of hidden sectors: 8
- first cluster is in sector # 260
- Update last access date for open-read-close = FALSE
- directory structure: VFAT
- file name format: 8-bit (extended-ASCII)
- root dir start sector: 245
- # of sectors per root: 15
- max # of entries in root: 240

FAT handler information:

- allocation group size: 4 clusters
- free space on volume: 44,380,160 bytes

PCI unit 0: Dev 0xb624, Rev 0x12, Chip BCM56624_B1, Driver BCM56624_B0
SOC unit 0 attached to PCI device BCM56624_B1

Adding BCM transport pointers

Configuring CPUTRANS TX

Configuring CPUTRANS RX

st_state(0) = 0x0

st_state(1) = 0x2

<186> JAN 01 00:00:15 0.0.0.0-1 UNKN[536870176]: bootos.c(218) 1 %
Event(0xaaaaaaaa)

Instantiating RamCP: as rawFs, device = 0x20001

Formatting RamCP: for DOSFS

Instantiating RamCP: as rawFs, device = 0x20001

Formatting...OK.

(Unit 1 - Waiting to select management unit)>

Applying Global configuration, please wait ...

Applying Interface configuration, please wait ...

console>

Device Default Settings

To return to device default settings use `delete startup-config` command at the privileged mode prompt (`#`), and reboot the device. Once device reloads – it is set with the default settings.

```
console>
console>enable
console#delete startup-config
Startup file was deleted
console#reload
Management switch has unsaved changes.
Are you sure you want to continue? (y/n) y
Configuration Not Saved!
Are you sure you want to reload the stack? (y/n) y
Reloading all switches..
```

Enabling Remote Management

1. Enter the `enable` command at the console to enter the Privileged EXEC screen mode as follows:

```
console>enable
console#
```

2. Connect the management station to the switch through one of the Ethernet ports, or through a network connected to the switch, using a CAT5 Cable.

This example uses port **1/xg1**.

3. Ensure (on the serial console) that the interface status changed to “up” and that the STP status is forwarding (after 30 seconds), as shown below:

```
console#
01-Jan-2000 01:43:03 %LINK-I-Up: Vlan 1
01-Jan-2000 01:43:03 %LINK-I-Up: 1/xg1
01-Jan-2000 01:43:34 %STP-I-PORTSTATUS: Port 1/xg1: STP status
Forwarding
```

4. Enable DHCP on the management interface.

a. Enter the **config** command at the console to enter the Configuration mode as follows:

```
console#config
```

b. Use the following command to set the IP address to DHCP and return to Privileged Exec mode:

```
console(config)#ip address dhcp
```

```
console(config)#exit
```

5. If the management station is a member of a remote network, and is not directly connected to the interface, configure a static route.

The configured IP address must belong to the same subnet as one of the switch IP interfaces. In this example the static address is 192.168.20.100.

```
console(config)#ip route 192.168.10.10 255.255.255.0 192.168.20.100
```

6. Ping the management station from the switch to ensure that connectivity has been achieved.

Wait 30 seconds for the port to be in STP forwarding mode before pinging the management station. In this example, the Management station IP is 50.1.1.2.

```
console>ping 50.1.1.2
```

```
64 bytes from 50.1.1.2: icmp_seq=1. time=0 ms
```

```
64 bytes from 50.1.1.2: icmp_seq=2. time=0 ms
```

```
64 bytes from 50.1.1.2: icmp_seq=3. time=0 ms
```

```
64 bytes from 50.1.1.2: icmp_seq=4. time=0 ms
```

```
----50.1.1.2 PING Statistics----
```

```
4 packets transmitted, 4 packets received, 0% packet loss
```

```
round-trip (ms) min/avg/max = 0/0/0
```

7. Define a user name and password to allow privileged level 15 switch access for a remote user (HTTP and HTTPS).

In this example, the user name **Dell**, the password is **Dell1234**, and the privilege level is 15. Privilege levels range from 1–15, with 15 being the highest level. Level 15 access is the only level of access for the Web interface.

```
console#config
```

```
console(config)#username Dell password Dell1234 level 15
```

```
console(config)#ip http authentication local
```

```
console(config)#ip https authentication local
```

```
console(config)#crypto certificate generate key_generate
Generating RSA private key, 1024 bit long modulus
console(config)#ip https server
```

8. Define a user name and password to allow access for a local user—console, Telnet, or Web Server, for example. The enable password for console, telnet, and SSH is **tommy123**, **bobby123**, and **jones123**, respectively.

In this example, the user name is **Dell**, the password is **Dell1234**, and the privilege level is **15**.

```
console(config)#username Dell password Dell1234 level 15
console(config)#aaa authentication login default local
console(config)#aaa authentication enable default line
console(config)#line console
console(config-line)#login authentication default
console(config-line)#enable authentication default
console(config-line)#password tommy123
console(config-line)#exit
console(config)#line telnet
console(config-line)#login authentication default
console(config-line)#enable authentication default
console(config-line)#password bobby123
console(config-line)#exit
console(config)#line ssh
console(config-line)#login authentication default
console(config-line)#enable authentication default
console(config-line)#password jones123
console(config-line)#exit
```

9. Save the **running-config** file to the **startup-config** file.

This ensures that the configuration just completed is the same if the switch is rebooted.

```
console(config)#exit
console#copy running-config startup-config
```

The switch is now configured and can be managed through the different options such as Telnet, Web browser interface, and others.

Configuring Secure Management Access (HTTPS)

When managing the switch securely through the standard Web browser, the SSL (Secure Socket Layer) security protocol is used.

To manage the switch securely through the standard Web browser, perform the following:

1. In order to configure the switch to allow HTTPS server, and to create a security key, use the commands **ip https server** and **crypto certificate 1 generate**:

```
console#configure
```

```
console(config)#crypto certificate 1 generate
```

```
Generating RSA private key, 1024 bit long modulus
```

```
console(config)#ip https server
```

```
console(config)#
```

2. Configure the management station the same as for a regular HTTP connection.
3. Connect to the switch through HTTPS by typing the address `https://device IP address` in the browser window (*https* must be typed).

The **Security Alert** window displays.

4. Click **Yes** to confirm accept the security certification (if it is not authenticated by a third party).

The **Login Screen** displays.

5. Enter the assigned user name and password.

The switch Dell OpenManage™ Switch Administrator displays.

Configuring System Information

Overview

Use the menus listed on the **System** page to define the switch's relationship to its environment. To display the **System** page, click **System** in the tree view. The **System** menu page contains links to the following features:

- Defining General Device Information
- Configuring SNTP Settings
- Managing Logs
- Defining IP Addressing
- Running Cable Diagnostics
- Managing Device Security
- Captive Portal
- Defining SNMP Parameters
- File Management
- Defining Advanced Settings
- Defining Stacking
- Trap Manager
- sFlow
- Industry Standard Discovery Protocol
- iSCSI Optimization

Defining General Device Information

The **General** menu page contains links to pages that allow you to configure device parameters. Use this page to access the following features:

- Asset
- System Health
- Versions
- System Resources
- Time Zone Configuration
- Summer Time Configuration
- Clock Detail
- Reset

Asset

Use the **Asset** page fields to configure and view general device information. To display the **Asset** page, click **System** → **General** → **Asset** in the tree view.

Figure 6-1. Asset

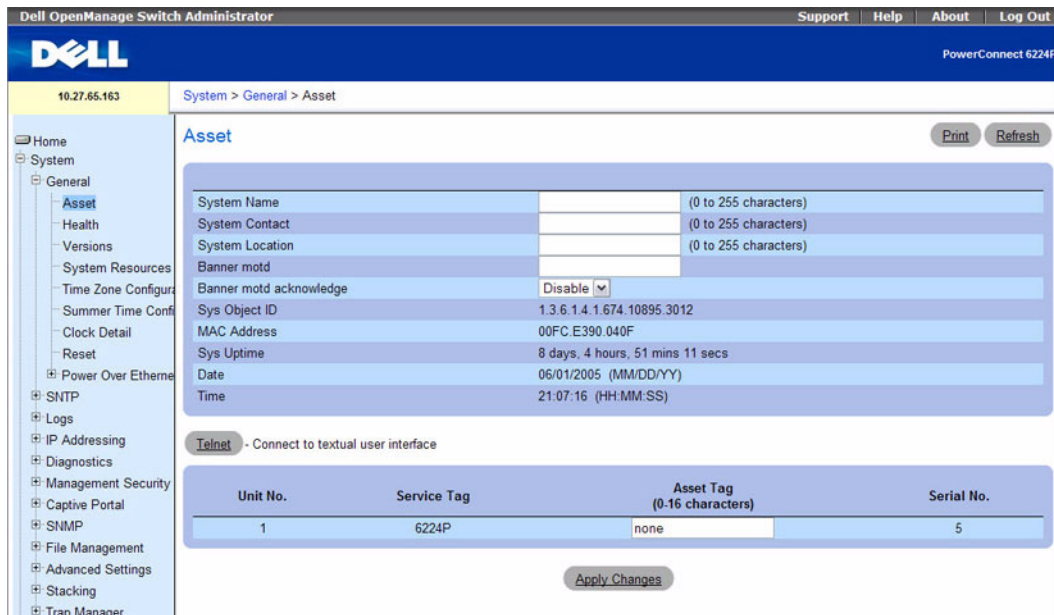

The **Asset** page contains the following fields:

- **System Name (0 – 255 characters)** — Use to assign device system name.
- **System Contact (0 – 255 characters)** — Use to assign the contact person’s name.
- **System Location (0 – 255 characters)** — Use to specify a system location.
- **Banner motd (message of the day)** — Enter the message that appears on the GUI banner (if enabled).
- **Banner motd acknowledge** — Enable to display the GUI banner motd in the GUI banner.
- **Sys Object ID** — The assigned System Object ID.
- **MAC Address** — Displays the MAC address of the switch.
- **Sys Uptime** — Displays the number of days, hours, and minutes since the last restart.
- **Date** — Displays the current system date. The format is month, day, year (MM/DD/YY). For example, 11/01/05 is November 01, 2005.
- **Time** — Displays the current system time. The format is hour, minute, second (HH:MM:SS). For example, 20:12:03 is 8:12:03 PM.
- **Unit No.** — Displays the switch’s position in the stack.
- **Service Tag** — Displays the service reference number used when servicing the device.
- **Asset Tag (0 – 16 characters)** — Displays the user-defined device reference.
- **Serial No.** — Displays the device serial number.

Defining System Information

1. Open the **Asset** page.
2. Define the following fields: **System Name**, **System Contact**, **System Location**, and **Asset Tag**.
3. Click **Apply Changes**.

The system parameters are applied, and the device is updated.

Initiating a Telnet Session

1. Open the **Asset** page.



NOTE: The appropriate telnet parameters are set prior to initiating the telnet session. See “Configuring an Initial Telnet Password” for information. If the client has a Microsoft® Windows® environment, the program must be configured for telnet. If the client has a Unix environment, the telnet program must exist in the path.

2. Click **Telnet**.

The prompt appears, indicating that the system is ready to receive input.

Configuring Device Information Using CLI Commands

For information about the CLI commands that perform this function, see the following chapters in the *CLI Reference Guide*:

- System Management Commands
- SNMP Commands
- Clock Commands

The following table summarizes the equivalent CLI commands you use to configure device information.

Table 6-1. Device Configuration Commands

CLI Command	Description
asset-tag	Use to specify the switch asset tag.
banner motd	Controls the display of message-of-the-day banners.
banner motd acknowledge	Use to require that a banner be acknowledged by the user.
set description	Use to associate a text description with a switch in the stack.
show boot-version	Use to display the boot image version details.
show system	Use to display system information.
show system ID	Use to display the system identity information.
snmp-server contact	Sets up a system contact (sysContact) string.
snmp-server location	Sets the system location string.

System Health

Use the **Health** page to view physical device information, including information about the switch’s power and ventilation sources.

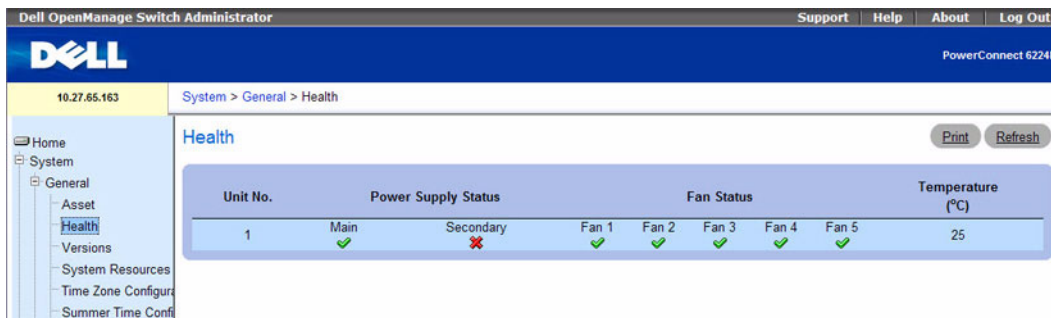

To display the **Health** page, click **System** → **General** → **Health** in the tree view.

Figure 6-2. Health



The **Health** page contains the following fields:

- **Unit No.** — Displays the unit’s position in the stack.

- **Power Supply Status** — Displays the power supply status.
 -  — The power supply is operating normally.
 -  — The power supply is not operating normally.
 - **Not Present** — The power supply is currently not present.
- **Temperature** — Displays the temperature at which the device is currently running.

Viewing System Health Information Using CLI Commands

For information about the CLI commands that perform this function, see the System Management Commands chapter in the *CLI Reference Guide*. The following table summarizes the equivalent CLI commands you use to view system health information.

Table 6-2. System Health Commands

CLI Command	Description
show system	Use to display system information.
show system power	Displays the power supply status.
show system temperature	Displays the system temperature and fan status.

Versions

Use the **Versions** page to view information about the software versions currently running.

To display the **Versions** page, click **System** → **General** → **Versions** in the tree view.

Figure 6-3. Versions

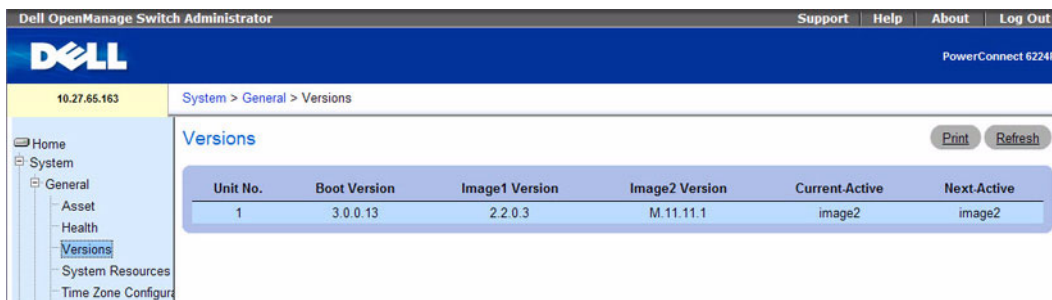

The **Versions** page contains the following fields:

- **Unit No.** — Displays the unit’s number in the stack.
- **Boot Version** — Displays the version of the boot code.
- **Image1 Version** — Displays the version number of one of the two available software images.
- **Image2 Version** — Displays the version number of the other of the two available software images.

- **Current-Active** — Displays the currently active software image.
- **Next-Active** — Displays the software image which will be loaded the next time the switch is rebooted.

Displaying Device Versions Using CLI Commands

For information about the CLI commands that perform this function, see the System Management Commands chapter in the *CLI Reference Guide*. The following table summarizes the equivalent CLI commands you use to display device versions information.

Table 6-3. Device Versions Commands

CLI Command	Description
show boot-version	Displays the boot image version details.
show version	Displays the system version.

System Resources

Use the **System Resources** page to view information about memory usage and task utilization.

To display the **System Resources** page, click **System** → **General** → **System Resources** in the tree view.

Figure 6-4. System Resources

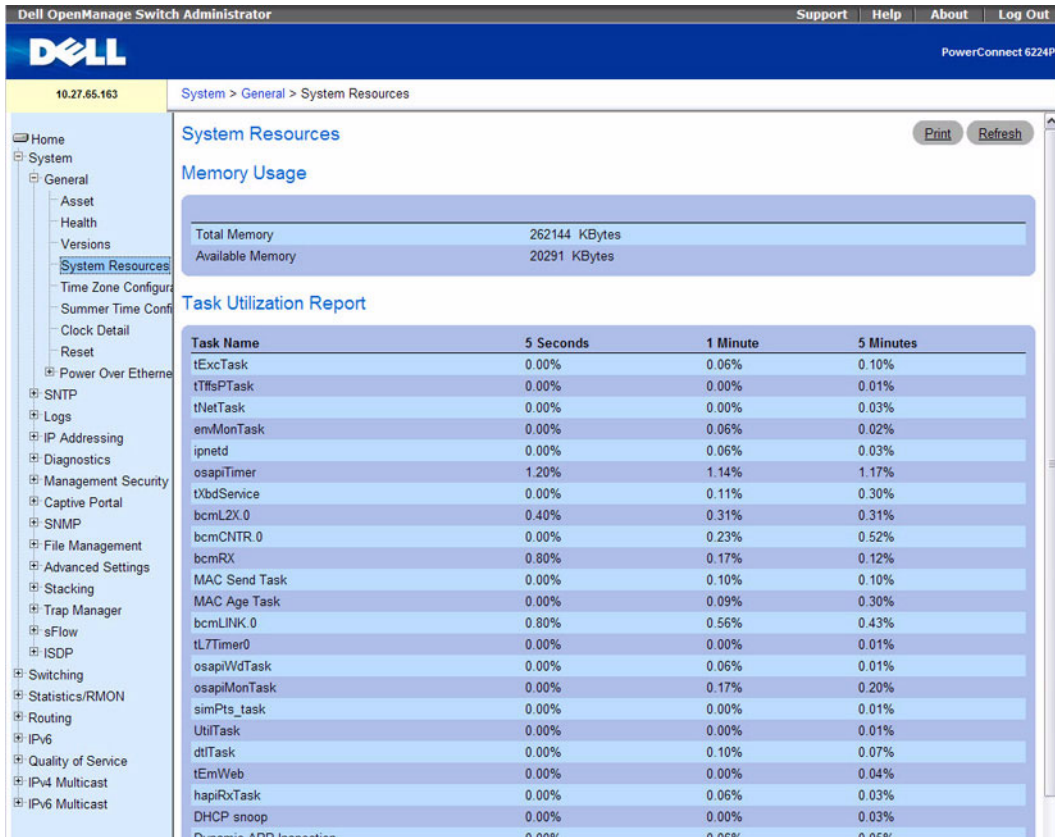

The System Resources page contains the following fields:

- **Total Memory** — Displays the total memory present on the switch.
- **Available Memory** — Displays the available memory (Free for allocation) present on the switch.
- **Task Name** — Name of the active task running on the switch.
- **Utilization (%)** — Percentage of CPU utilized by the corresponding task in the last:
 - Five seconds
 - One minute
 - Five minutes

Displaying System Resources Using CLI Commands

For information about the CLI commands that perform this function, see the System Management Commands chapter in the *CLI Reference Guide*. The following table summarizes the equivalent CLI commands you use to display system resources information.

Table 6-4. System Resources Commands

CLI Command	Description
show memory cpu	Checks the total and available RAM space on the switch.
show process cpu	Checks the CPU utilization for each process currently running on the switch.

Time Zone Configuration

Use the **Time Zone Configuration** to configure the time zone difference from Coordinated Universal Time (UTC).

To display the **Time Zone Configuration** page, click **System** → **General** → **Time Zone Configuration** in the tree view.

Figure 6-5. Time Zone Configuration

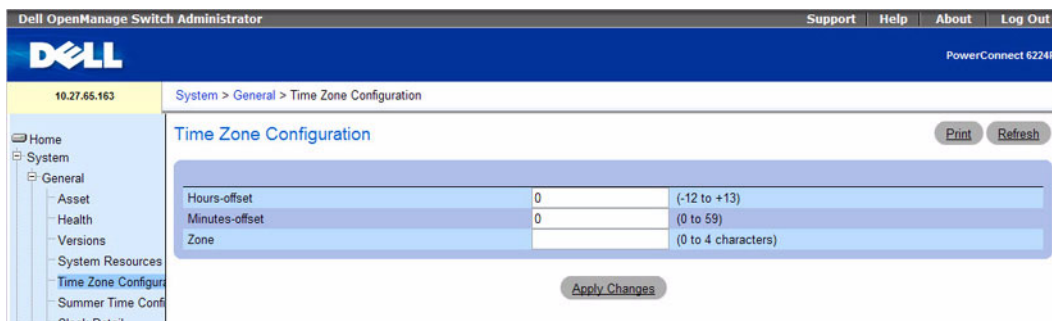

The **Time Zone Configuration** page contains the following fields:

- **Hours-offset** — Set the hours difference from UTC. (Range: -12 to +13)
- **Minutes-offset** — Set the minutes difference from UTC. (Range: 0–59)
- **Zone** — Set the acronym of the time zone. (Range: 0–4 characters)

Defining the Time Zone Parameters

1. Open the **Time Zone Configuration** page.
2. Define the fields as needed.
3. Click **Apply Changes**.

The time zone settings are modified, and the device is updated.

Configuring Time Zone Settings Using CLI Commands

For information about the CLI commands that perform this function, see the Clock Commands chapter in the *CLI Reference Guide*. The following table summarizes the equivalent CLI commands you use to configure time zone settings.

Table 6-5. Time Zone Settings Commands

CLI Command	Description
clock timezone	Sets the offset to Coordinated Universal Time.
no clock timezone	Resets the time zone settings.

Summer Time Configuration

Use the **Summer Time Configuration** page to specify a defined summer time duration and offset.

To display the **Summer Time Configuration** page, click **System** → **General** → **Summer Time Configuration** in the tree view.

Figure 6-6. Summer Time Configuration

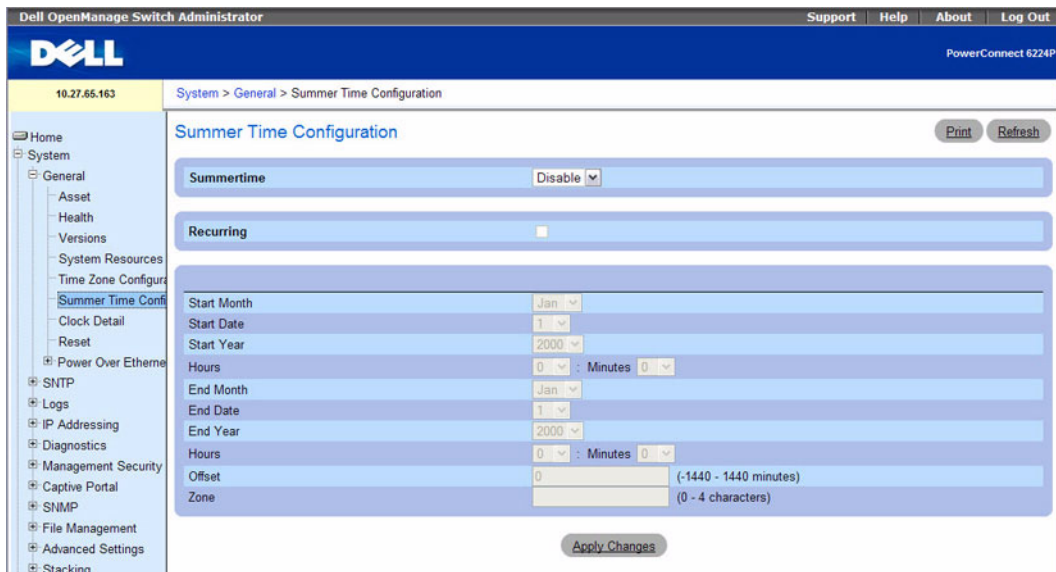

The fields on the **Summer Time Configuration** page change when you select or clear the Recurring check box. The **Summer Time Configuration** page contains the following fields:

- **Recurring** — Select the check box to indicate that the configuration is to be repeated every year.

- **Location** — This field displays only when the Recurring check box is selected. The summer time configuration is predefined for the United States and European Union. To set the summer time for a location other than the USA or EU, select None.
- **Start Week** — Select the starting week number. This field displays only when the Recurring check box is selected.
- **Start Day** — Select the starting day number. This field displays only when the Recurring check box is selected.
- **Start Month** — Select the starting month.
- **Start Time** — Select the starting time in hh:mm format.
- **Start Date** — Select the starting date. This field displays only when the Recurring check box is cleared.
- **Start Year** — Select the starting year. This field displays only when the Recurring check box is cleared.
- **End Week** — Select the ending week number. This field displays only when the Recurring check box is selected.
- **End Day** — Select the ending day number. This field displays only when the Recurring check box is selected.
- **End Month** — Select the ending month.
- **End Time** — Select the ending time in hh:mm format.
- **End Date** — Select the ending date. This field displays only when the Recurring check box is cleared.
- **End Year** — Select the ending year. This field displays only when the Recurring check box is cleared.
- **Offset** — Set the number of minutes to add during summer time in the range 0 to 1440.
- **Zone** — Set the acronym of the time zone to be displayed when summer time is in effect.

Defining the Summer Time Parameters

1. Open the **Summer Time Configuration** page.
2. Define the fields as needed.
3. Click **Apply Changes**.

The summer time settings are modified, and the device is updated.

Configuring Summer Time Parameters Using CLI Commands

For information about the CLI commands that perform this function, see the **Clock Commands** chapter in the *CLI Reference Guide*. The following table summarizes the equivalent CLI commands you use to configure summer time parameters.

Table 6-6. Summer Time Parameters Commands

CLI Command	Description
clock summer-time recurring	Sets the summertime offset to UTC recursively every year.
clock summer-time date	Sets the summertime offset to UTC.
no clock summer-time	Resets the recurring summertime configuration.

Clock Detail

Use the **Clock Detail** page to set the time and date or view information about the current time, time zone, and summer time settings.

To display the **Clock Detail** page, click **System** → **General** → **Clock Detail** in the tree view.

Figure 6-7. Clock Detail

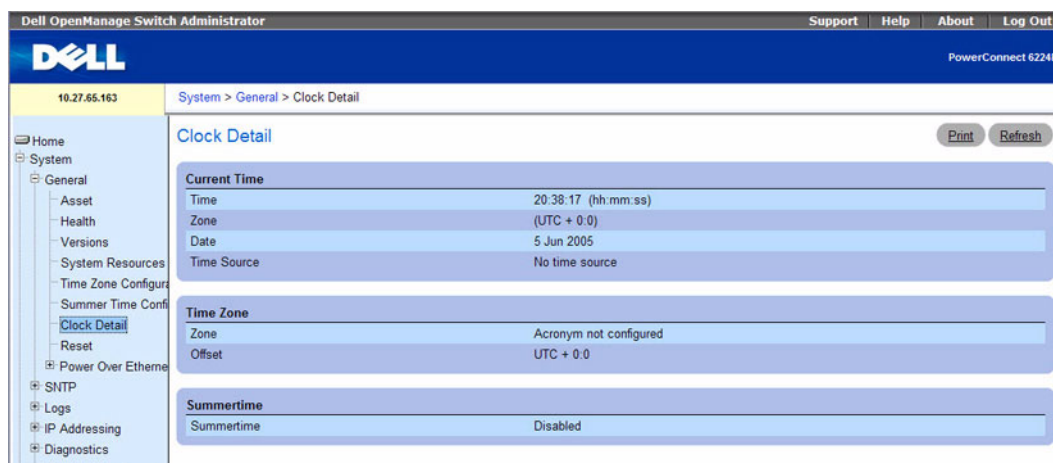

The **Clock Detail** page provides information about the following clock features:

- **Current Time** — This section allows you to set the current time and date.
- **Time Zone** — This section displays the time zone settings.
- **Summertime** — This section displays the summer time settings.

Displaying Clock Detail Using CLI Commands

For information about the CLI commands that perform this function, see the **Clock Commands** chapter in the *CLI Reference Guide*. The following table summarizes the equivalent CLI commands you use to display clock detail information.

Table 6-7. Clock Detail Commands

CLI Command	Description
clock set	Sets the current date and time.
show clock	Displays the time and date of the system clock.

Reset

Use the **Reset** page to reset the device.

To display the **Reset** page, click **System** → **General** → **Reset** in the tree view.

Figure 6-8. Reset

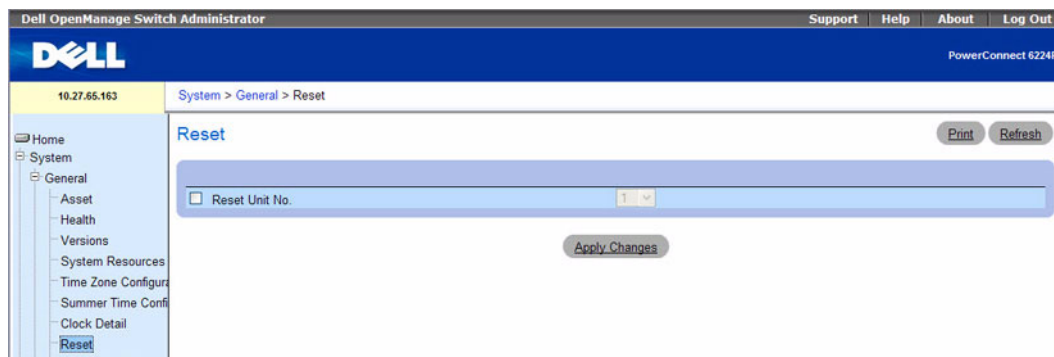

The **Reset** page contains the following fields:

- **Reset Unit No.** — Use to select the device in the stack that needs to be reset.

Resetting the Device

1. Open the **Reset** page.
2. Click **Reset Unit No.**
3. Select either **Individual Unit** or **All**.
4. Click **Apply Changes** button.
5. When the confirmation message displays, click **OK**.

The selected device is reset. After the device is reset, enter a user name and password.

Configuring SNTP Settings

The device supports the Simple Network Time Protocol (SNTP). SNTP assures accurate network device clock time synchronization up to the millisecond. Time synchronization is performed by a network SNTP server. The device operates only as an SNTP client and cannot provide time services to other systems.

Time sources are established by Stratum. Stratum defines the accuracy of the reference clock. The higher the stratum (where zero is the highest), the more accurate the clock. The device receives time from stratum 1 and above since it is itself a stratum 2 device.

The following is an example of stratum:

- **Stratum 0** — A real time clock is used as the time source, for example, a GPS system.
- **Stratum 1** — A server that is directly linked to a Stratum 0 time source is used. Stratum 1 time servers provide primary network time standards.
- **Stratum 2** — The time source is distanced from the Stratum 1 server over a network path. For example, a Stratum 2 server receives the time over a network link, through NTP, from a Stratum 1 server.

Information received from SNTP servers is evaluated based on the time level and server type.

SNTP time definitions are assessed and determined by the following time levels:

- **T1** — Time at which the original request was sent by the client.
- **T2** — Time at which the original request was received by the server.
- **T3** — Time at which the server sent a reply.
- **T4** — Time at which the client received the server's reply.

The device can poll Unicast and Broadcast server types for the server time.

Polling for Unicast information is used for polling a server for which the IP address is known. SNTP servers that have been configured on the device are the only ones that are polled for synchronization information. T1 through T4 are used to determine server time. This is the preferred method for synchronizing device time because it is the most secure method. If this method is selected, SNTP information is accepted only from SNTP servers defined on the device using the **SNTP Servers** page.

Broadcast information is used when the server IP address is unknown. When a Broadcast message is sent from an SNTP server, the SNTP client listens to the message. If Broadcast polling is enabled, any synchronization information is accepted, even if it has not been requested by the device. This is the least secure method.

The device retrieves synchronization information, either by actively requesting information or at every poll interval. If Unicast and Broadcast polling are enabled, the information is retrieved in this order:

- Information from servers defined on the device is preferred. If Unicast polling is not enabled or if no servers are defined on the device, the device accepts time information from any SNTP server that responds.

- If more than one Unicast device responds, synchronization information is preferred from the device with the lowest stratum.
- If the servers have the same stratum, synchronization information is accepted from the SNTP server that responded first.

MD5 (Message Digest 5) Authentication safeguards device synchronization paths to SNTP servers. MD5 is an algorithm that produces a 128-bit hash. MD5 is a variation of MD4, and increases MD4 security. MD5 verifies the integrity of the communication, authenticates the origin of the communication.

The **SNTP** menu page contains links to pages that allow you to configure SNTP parameters.

To display the **SNTP** page, click **System** → **SNTP** in the tree view.

Use this page to go to the following features:

- SNTP Global Settings
- SNTP Authentication
- SNTP Server

SNTP Global Settings

Use the SNTP Global Settings page to view and adjust SNTP parameters.

To display the SNTP Global Settings page, click **System** → **SNTP** → **Global Settings** in the tree view.

Figure 6-9. SNTP Global Settings

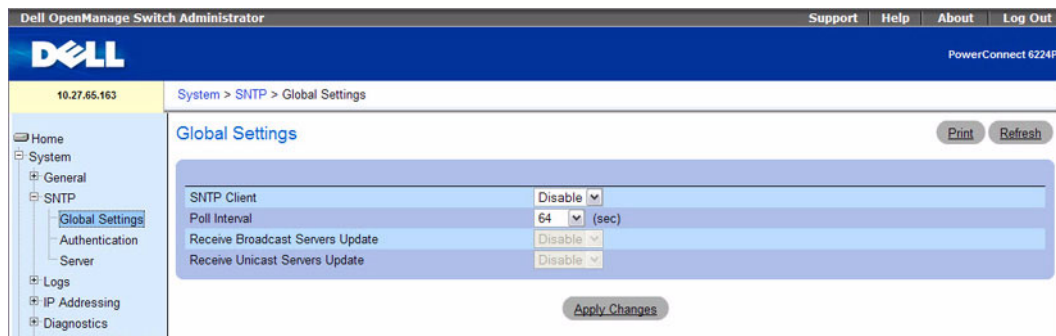

The **SNTP Global Settings** page contains the following fields:

- **SNTP Client** — Use drop-down list to enable or disable the client. If the client is disabled, some of the fields below are also disabled.
- **Poll Interval** — Defines the interval (in seconds) at which the SNTP server is polled for Unicast information. The range is 60–1024 seconds.

- **Receive Broadcast Servers Update** — If enabled, listens to the SNTP servers for Broadcast server time information on the selected interfaces. The device is synchronized whenever an SNTP packet is received, even if synchronization was not requested.
- **Receive Unicast Servers Update** — If enabled, polls the SNTP servers defined on the device for Unicast server time information.

Defining SNTP Global Parameters

1. Open the **SNTP Global Settings** page.
2. Define the fields as needed.
3. Click **Apply Changes**.

The SNTP global settings are modified, and the device is updated.

Defining SNTP Global Parameters Using CLI Commands

For information about the CLI commands that perform this function, see the *Clock Commands* chapter in the *CLI Reference Guide*. The following table summarizes the equivalent CLI commands you use to define SNTP global parameters.

Table 6-8. SNTP Global Parameters Commands

CLI Command	Description
sntp broadcast client enable	Use to enable a Simple Network Time Protocol (SNTP) Broadcast client.
sntp client poll timer	Use to set the polling time for the SNTP client.
sntp server	Use to configure the device to use SNTP to request and accept SNTP traffic from a specified server.

SNTP Authentication

The **SNTP Authentication** page lets you enable SNTP authentication between the device and an SNTP server, and to select the desired SNTP server. Use the **SNTP Authentication** page to enable or disable SNTP authentication, to modify the authentication key for a selected encryption key ID, to designate the selected authentication key as a trusted key, and to remove the selected encryption key ID.

Click **System** → **SNTP** → **Authentication** in the tree view to display the **SNTP Authentication** page.

Figure 6-10. SNMP Authentication

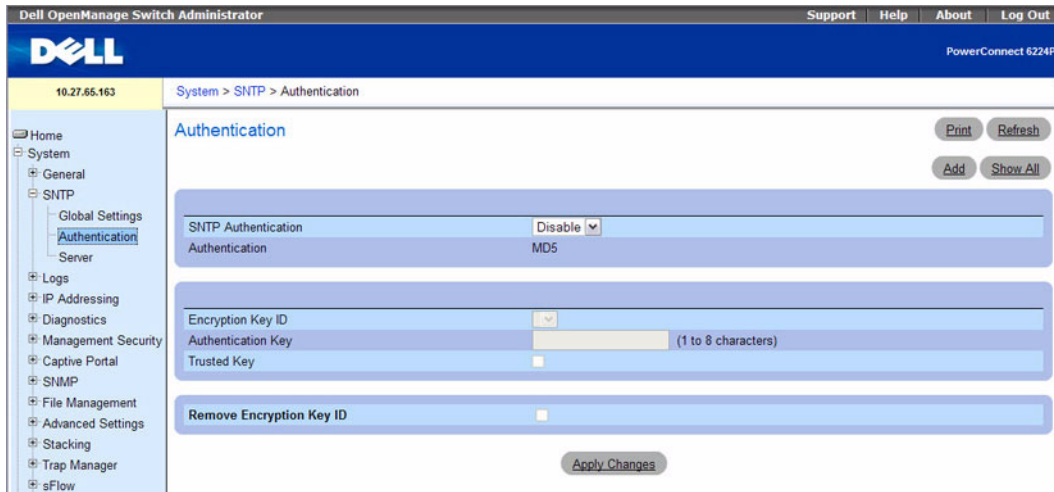

The SNMP Authentication page contains the following fields:

- **SNMP Authentication** — If enabled, requires authenticating an SNMP session between the device and an SNMP server.
- **Authentication** — Type of authentication. System supports MD5 only.
- **Encryption Key ID** — Contains a list of user-defined key IDs used to authenticate the SNMP server and device. Possible field values are 1–4294767295.
- **Authentication Key (1–8 Characters)** — Displays the key used for authentication.
- **Trusted Key** — Check to specify the encryption key used (Unicast) or uncheck to authenticate the SNMP server (Broadcast).
- **Remove Encryption Key ID** — Check to remove the selected authentication key.

Adding an SNMP Authentication Key

1. Open the SNMP Authentication page.
2. Click Add.

The Add Authentication Key page displays:

Figure 6-11. Add Authentication Key

[System](#) > [SNTP](#) > Authentication

Add Authentication Key

[Print](#) [Refresh](#)

Encryption key ID (1-4294767295)	<input type="text"/>
Authentication key (1-8 characters)	<input type="text"/>
Trusted Key	<input type="checkbox"/>

[Apply Changes](#) [Back](#)

3. Define the fields as needed.
4. Click **Apply Changes**.
The SNTP authentication key is added, and the device is updated.

Displaying the Authentication Key Table

1. Open the SNTP Authentication page.
2. Click **Show All**.
The **Authentication Key Table** page displays:

Figure 6-12. Authentication Key Table

[Authentication Key Table](#) [Print](#) [Refresh](#)

	Encryption Key ID	Authentication Key	Trusted Key	Remove	
1	4545	xsgdw	Yes	<input type="checkbox"/>	Edit

[Apply Changes](#) [Back](#)

Removing an Authentication Key

1. Open the SNTP Authentication page.
2. Click **Show All**.
The **Authentication Key Table** page displays.
3. Select an **Authentication Key Table** entry by checking its the **Remove** check box.
4. Click **Apply Changes**.
The entry is removed, and the device is updated.

Defining SNTP Authentication Settings Using CLI Commands

For information about the CLI commands that perform this function, see the Clock Commands chapter in the *CLI Reference Guide*. The following table summarizes the equivalent CLI commands you use to define SNTP authentication settings.

Table 6-9. SNTP Authentication Settings Commands

CLI Command	Description
sntp authenticate	Use to require server authentication for received Network Time protocol (NTP) traffic.
sntp authentication-key	Use to define an authentication key for SNTP.
sntp trusted-key	Use to authenticate the identity of a system to which SNTP will synchronize.

SNTP Server

Use the SNTP Server page to view and modify information for enabling SNTP servers, and to add new SNTP servers.

To display the SNTP Server page, click System →SNTP →SNTP Server in the tree view.

Figure 6-13. SNTP Servers

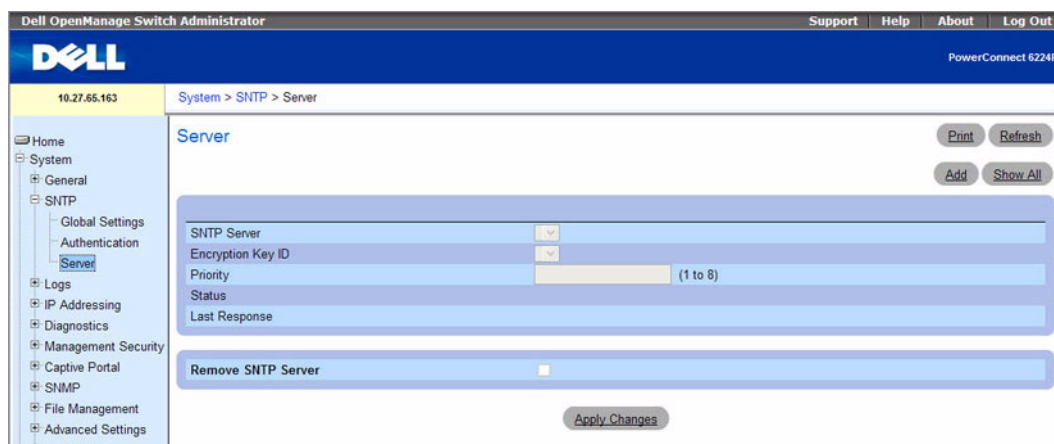

The SNTP Servers page contains the following fields:

- **SNTP Server** — Selects user-defined SNTP server IP address from a drop-down menu. Up to eight SNTP servers can be defined by using the **Add** button.
- **Encryption Key ID** — Specifies user-defined key ID used to communicate between the SNTP server and device. The encryption key ID is defined in the **SNTP Authentication** page.

- **Priority (1–8)** — Specifies the priority of this server entry in determining the sequence of servers to which SNTP requests are sent. Values are 1 to 8, and the default is 1. Servers with lowest numbers have priority.
- **Status** — Displays the operating SNTP server status. The possible field values are:
 - **Up** — The SNTP server is currently operating normally.
 - **Down** — Indicates that a SNTP server is currently not available. For example, the SNTP server is currently not connected or is currently down.
 - **In progress** — The SNTP server is currently sending or receiving SNTP information.
 - **Unknown** — The progress of the SNTP information currently being sent is unknown. For example, the device is currently looking for an interface.
- **Last Response** — Displays the last time a response was received from the SNTP server.
- **Remove SNTP Server**— Removes a specified SNTP server from the SNTP Servers list when checked.

Adding an SNTP Server

1. Open the SNTP Servers page.
2. Click Add.

The Add SNTP Server page displays.

Figure 6-14. Add SNTP Server

3. Define the fields as needed.
4. Click **Apply Changes**.

The SNTP server is added, and the device is updated.

Displaying the SNTP Servers Table

1. Open the SNTP Servers page.
2. Click **Show All**.

The SNTP Servers Table page displays.

Figure 6-15. SNTP Servers Table

	SNTP Server	Encryption Key ID	Priority	Status	Last Response	Remove
1	10.240.1.10	None	1	Up	Thu 1 Jan 1970 00:00:00	<input type="checkbox"/> Edit

Modifying an SNTP Server

1. Open the SNTP Servers page.
2. Click **Show All**.
The SNTP Servers Table opens.
3. Click **Edit** next to the SNTP Server entry you wish to modify.
4. Modify the relevant fields.
5. Click **Apply Changes**.
The SNTP server information is updated.

Removing the SNTP Server

1. Open the SNTP Servers page.
2. Click **Show All**.
The SNTP Servers Table opens.
3. Select an SNTP Server entry.
4. Check the **Remove** check box.
5. Click **Apply Changes**.
The entry is removed, and the device is updated.

Defining SNTP Servers Using CLI Commands

For information about the CLI commands that perform this function, see the Clock Commands chapter in the *CLI Reference Guide*. The following table summarizes the equivalent CLI commands you use to define SNTP servers.

Table 6-10. SNTP Servers Commands

CLI Command	Description
show sntp configuration	Displays the SNTP configuration.
show sntp status	Displays the SNTP status.
sntp server	Configures the SNTP server to use SNTP to request and accept NTP traffic from it.

Managing Logs

The switch may generate messages in response to events, faults, or errors occurring on the platform as well as changes in configuration or other occurrences. These messages are stored both locally on the platform and forwarded to one or more centralized points of collection for monitoring purposes as well as long term archival storage. Local and remote configuration of the logging capability includes filtering of messages logged or forwarded based on severity and generating component.

The *in-memory* log stores messages in memory based upon the settings for message component and severity. On stackable systems, this log exists only on the top of stack platform. Other platforms in the stack forward their messages to the top of stack log. Access to in-memory logs on other than the top of stack platform is not supported.

The *persistent* log is stored in persistent storage. Two types of persistent logs may be configured.

- The first log type is the *system startup log*. The system startup log stores the first N messages received after system reboot. This log always has the log full operation attribute set to stop on full and can store up to 32 messages.
- The second log type is the *system operation log*. The system operation log stores the last N messages received during system operation. This log always has the log full operation attribute set to overwrite. This log can store up to 1000 messages.

Either the system startup log or the system operation log stores a message received by the log subsystem that meets the storage criteria, but not both. On system startup, if the startup log is configured, it stores messages up to its limit. The operation log, if configured, then begins to store the messages.

The system keeps up to three versions of the persistent logs, named <FILE>0.txt, <FILE>1.txt, and <FILE>2.txt. Upon system startup, <FILE>2.txt is removed, <FILE>1.txt is renamed <FILE>2.txt, <FILE>0.txt is renamed <FILE>1.txt, <FILE>0.txt is created and logging begins into <FILE>0.txt. (Replace <FILE> in the above example to specify o1og for the operation log and s1og for the startup log.)

The local persistent logs can be retrieved by using the CLI, xmodem over the local serial cable, and TFTP.

To display the **Logs** menu page, click **System** → **Logs** in the tree view. Use this page access the following features:

- Global Settings

- RAM Log Table
- Log File
- Remote Log Server Settings

Global Settings

Use the **Global Settings** page to enable logs globally, and to define log parameters. The **Severity** log messages are listed from the highest severity to the lowest.

To display the **Global Settings** page, click **System** → **Logs** → **Global Settings** in the tree view.

Figure 6-16. Global Settings

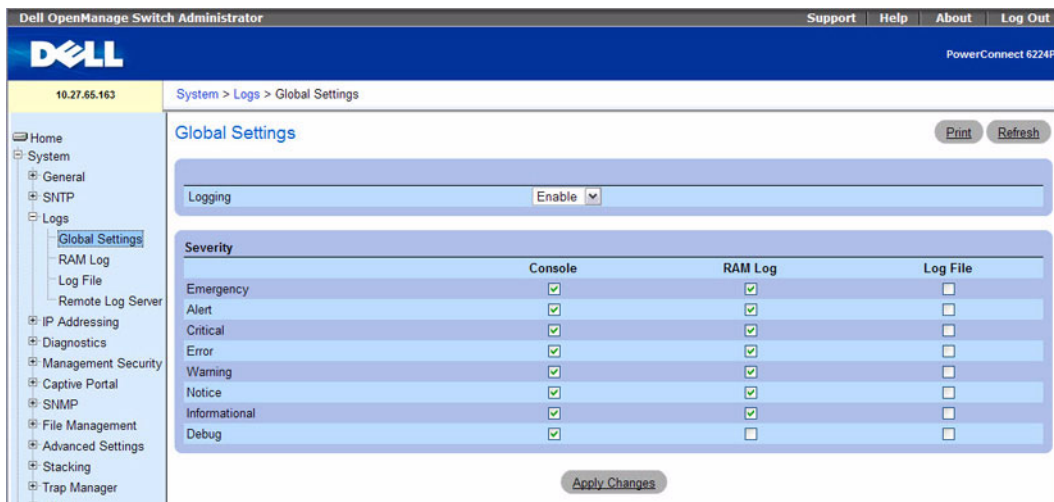

The **Global Settings** page contains the following fields:

- **Logging** — Enables device global logs for Cache, File, and Server Logs. All logs which are printed to the console are saved to the log files. The possible field values are:
 - **Enable** — Enables saving logs in Cache (RAM), File (FLASH), and an External Server.
 - **Disable** — Disables saving logs. It is not possible to disable logging of logs that are printed to console.

Severity

Use the check boxes in this section to adjust the sensitivity of the console, persistent memory, and log files.

When you select a specific level, all of the levels above it are automatically selected. For example, if you select **Error**, the system automatically selects **Error**, **Critical**, **Alert**, and **Emergency**. If you deselect **Error**, all of the levels below (for example, **Error**, **Warning**, **Notice**, **Informational**, **Debug**) are deselected.

- **Emergency** — The highest level warning level. If the device is down or not functioning properly, an emergency log is saved to the device.
- **Alert** — The second highest warning level. An alert log is saved if there is a serious device malfunction, such as all device features being down.
- **Critical** — The third highest warning level. A critical log is saved if a critical device malfunction occurs, for example, two device ports are not functioning, while the rest of the device ports remain functional.
- **Error** — A device error has occurred, such as if a port is offline.
- **Warning** — The lowest level of a device warning.
- **Notice** — Provides the network administrators with device information.
- **Informational** — Provides device information.
- **Debug** — Provides detailed information about the log. Debugging should only be entered by qualified support personnel.

The check boxes appear under the following three columns:

- **Console** — Logs sent to the console.
- **RAM Logs** — Logs sent to the (Cache) RAM.
- **Log File** — Logs sent to the File (FLASH).

Enabling Logs

1. Open the **Global Settings** page.
2. Select **Enable** in the **Logging** drop-down menu.
3. Use the check boxes to select log type and severity.



NOTE: When you select a severity level, all higher severity levels are automatically selected.

4. Click **Apply Changes**.

The log settings are saved, and the device is updated.

Enabling Global Logs Using CLI Commands

For information about the CLI commands that perform this function, see the *Syslog Command* chapter in the *CLI Reference Guide*. The following table summarizes the equivalent CLI commands you use to enable global logs.

Table 6-11. Global Logs Commands

CLI Command	Description
logging	Enables logging.
show logging	Displays the state of logging and the syslog messages stored in the internal buffer.

RAM Log Table

Use the **RAM Log Table** page to view information about specific RAM (cache) log entries, including the time the log was entered, the log severity, and a description of the log.

To display the **RAM Log Table**, click **System** → **Logs** → **RAM Log** in the tree view.

Figure 6-17. RAM Log Table

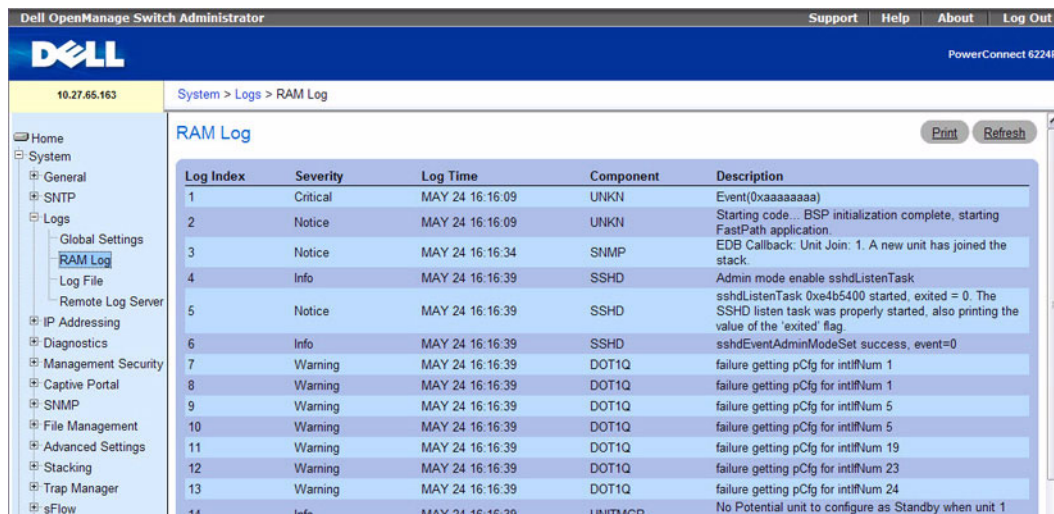

Log Index	Severity	Log Time	Component	Description
1	Critical	MAY 24 16:16:09	UNKN	Event(0xaaaaaaaa)
2	Notice	MAY 24 16:16:09	UNKN	Starting code ... BSP initialization complete, starting FastPath application.
3	Notice	MAY 24 16:16:34	SNMP	EDB Callback: Unit Join: 1. A new unit has joined the stack.
4	Info	MAY 24 16:16:39	SSHD	Admin mode enable sshdListenTask
5	Notice	MAY 24 16:16:39	SSHD	sshdListenTask 0xe4b5400 started, exited = 0. The SSHD listen task was properly started, also printing the value of the 'exited' flag.
6	Info	MAY 24 16:16:39	SSHD	sshdEventAdminModeSet success, event=0
7	Warning	MAY 24 16:16:39	DOT1Q	failure getting pCfg for intflNum 1
8	Warning	MAY 24 16:16:39	DOT1Q	failure getting pCfg for intflNum 1
9	Warning	MAY 24 16:16:39	DOT1Q	failure getting pCfg for intflNum 5
10	Warning	MAY 24 16:16:39	DOT1Q	failure getting pCfg for intflNum 5
11	Warning	MAY 24 16:16:39	DOT1Q	failure getting pCfg for intflNum 19
12	Warning	MAY 24 16:16:39	DOT1Q	failure getting pCfg for intflNum 23
13	Warning	MAY 24 16:16:39	DOT1Q	failure getting pCfg for intflNum 24
14	Info	MAY 24 16:16:39	UNITMGR	No Potential unit to configure as Standby when unit 1

The **RAM Log Table** contains the following fields:

- **Log Index** — Indicates the Log Number within the Log RAM Table.
- **Severity** — The log severity.
- **Log Time** — The time at which the log was entered in the Log RAM Table.
- **Component** — The component being logged.
- **Description** — The log description.

Removing Log Information

1. Open the **RAM Log Table** page.
2. Click **Clear Log**.

The log information is removed from the log file table, and the device is updated.

Displaying Log Information Using CLI Commands

For information about the CLI commands that perform this function, see the **Syslog Commands** chapter in the *CLI Reference Guide*. The following table summarizes the equivalent CLI commands you use to remove log information.

Table 6-12. Log Information Commands

CLI Command	Description
clear logging	Use to clear messages from the logging buffer.
show logging	Displays the state of logging and the syslog messages stored in the internal buffer.

Log File

The **Log File** contains information about specific log entries, including the time the log was entered, the log severity, and a description of the log.

To display the **Log File**, click **System** → **Logs** → **Log File** in the tree view.

Figure 6-18. Log File

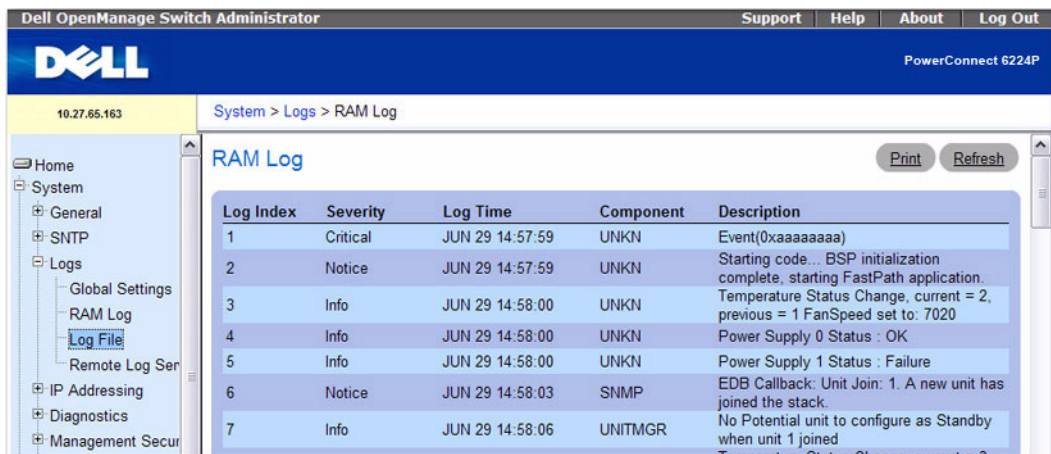

The **Log File Table** page contains the following fields:

- **Log Index** — The Log Number within the Log File Table.
- **Severity** — The log severity.
- **Log Time** — The time at which the log was entered in the Log File Table.
- **Component** — The component being logged.
- **Description** — The log description.

Removing Log Information

1. Open the **Log File Table** page.
2. Click **Clear Log**.

The log information is removed from the log file table, and the device is updated.

Removing Log Information Using CLI Commands

For information about the CLI commands that perform this function, see the Syslog Commands chapter in the *CLI Reference Guide*. The following table summarizes the equivalent CLI commands you use to remove log information.

Table 6-13. Log File Commands

CLI Command	Description
clear logging file	Use to clear messages from the logging file.
show logging file	Displays the state of logging and the syslog messages stored in the logging file.

Remote Log Server Settings

Use the **Remote Log Server Settings** page to view the available log servers, to define new log servers, and to set the severity of the log events sent to the server.

To display the **Remote Log Server Settings** page, click **System** → **Logs** → **Remote Log Server**.

Figure 6-19. Remote Log Server Settings

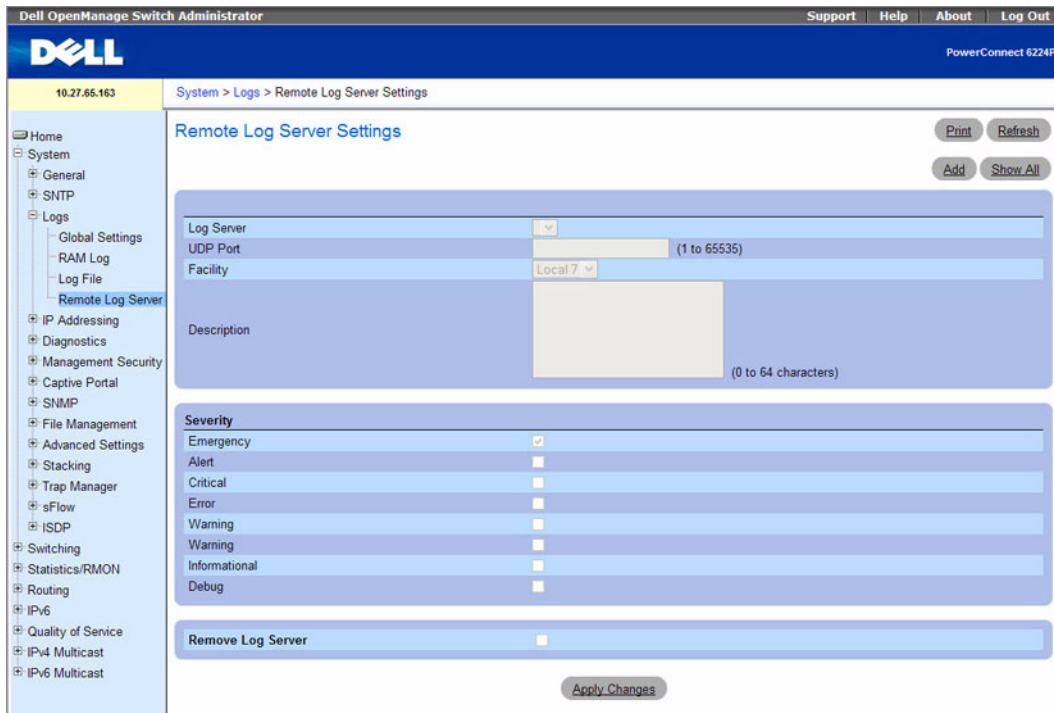

The **Remote Log Server Settings** page contains the following fields:

- **Log Server** — Server to which logs can be sent.
- **UDP Port (1–65535)** — Sets the UDP port from which the logs are sent. The default value is 514.
- **Facility** — A user-defined application from which system logs are sent to the remote server. Only one facility can be assigned to a single server. If a second facility level is assigned, the first facility level is overridden. All applications defined for a device use the same facility on a server. The possible field values are from **Local 0** to **Local 7**.
- **Description** — Sets the server description. The maximum length is 64 characters.
- **Severity** — Selects the log severity. Selecting a severity level automatically selects all higher severity levels.
- **Remove Log Server** — Removes a server from the **Log Server** list. Checking the check box removes the server from the list. Leaving the box unchecked maintains the server in the list.

The **Remote Log Server Settings** page also contains a severity list. The severity definitions are the same as the severity definitions on the **RAM Log Table** page.

Sending Logs to a Server

1. Open the **Remote Log Server Settings** page.
2. Define the **UDP Port**, **Facility**, and **Description** fields.
3. Select the log type and log severity by using the **Log Parameters** check boxes.



NOTE: When you select a severity level, all higher severity levels are automatically selected.

4. Click **Apply Changes**.

The log settings are saved, and the device is updated.

Adding a New Server

1. Open the **Remote Log Server Settings** page.
2. Click **Add** to display the **Add Remote Log Server** page.



NOTE: Before adding a new server, determine the IP address of the remote log server.

Figure 6-20. Add Remote Log Server Settings

Add Remote Log Server Print Refresh

Log Server	
UDP Port (1-65535)	514
Facility	Local 7
Description (0-64 characters)	

Severity

Emergency	<input checked="" type="checkbox"/>
Alert	<input checked="" type="checkbox"/>
Critical	<input checked="" type="checkbox"/>
Error	<input checked="" type="checkbox"/>
Warning	<input checked="" type="checkbox"/>
Notice	<input checked="" type="checkbox"/>
Informational	<input checked="" type="checkbox"/>
Debug	<input type="checkbox"/>

Apply Changes Back

3. Complete the fields in the dialog and click **Apply Changes**.

The **Remote Log Server Settings** page displays the server in the **Log Server** list only after you go back to the **Remote Log Server Settings** page.

Viewing/Removing a Log Server

1. Open the **Remote Log Server Settings** page.
2. Click **Show All** to display the **Remote Log Servers Table** page.

Figure 6-21. Show All Log Servers

Remote Log Servers Table Print Refresh

Log Server	UDP Port	Facility	Description	Minimum Severity	Remove
10.240.10.1	23	Local 7		Informational	<input checked="" type="checkbox"/> Edit

Apply Changes Back

3. To remove a server, check the corresponding **Remove** check box.
4. Click **Apply Changes**.

The server is removed, and the device is updated.

Working with Remote Server Logs Using CLI Commands

For information about the CLI commands that perform this function, see the Syslog Commands chapter in the *CLI Reference Guide*. The following table summarizes the equivalent CLI commands you use to work with remote server logs.

Table 6-14. Remote Server Logs Commands

CLI Command	Description
logging facility	Use to set the facility for logging messages.
logging <host>	Logs messages to the specified syslog server.

Defining IP Addressing

Use the **IP Addressing** page to assign management interface and default gateway IP addresses, negotiate with the Domain Name System, set a Default Domain Name, perform Host Name Mapping, and define ARP and DHCP parameters for the interfaces.

To display the **IP Addressing** page, click **System** → **IP Addressing** in the tree view. Use this page to go to the following features:

- Domain Name Server (DNS)
- Default Domain Name
- Host Name Mapping
- Dynamic Host Name Mapping
- ARP Table
- IPv6 Management Features

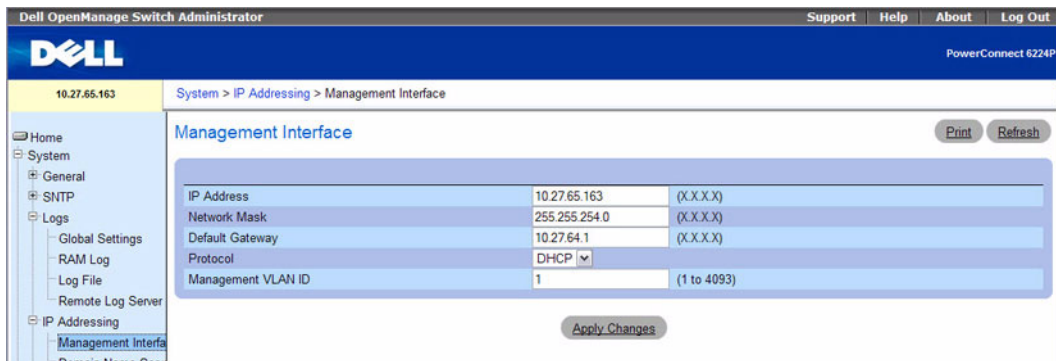

Domain Name Server (DNS)

The Domain Name System converts user-defined domain names into IP addresses. Each time a domain name is assigned, this service translates the name into a numeric IP address. Domain Name System servers maintain domain name databases and their corresponding IP addresses.

Use the **Domain Name Server (DNS)** page to enable and activate specific DNS servers.

To display the **Domain Name Server** page, click **System** → **IP Addressing** → **Domain Name Server** in the tree view.

Figure 6-22. Domain Name Server

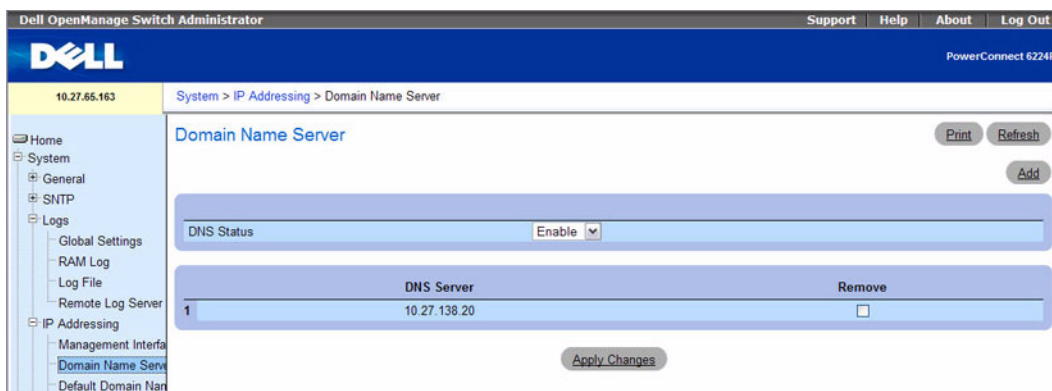

The **Domain Name Server (DNS)** page contains the following fields:

- **DNS Status** — Enables or disables translating DNS names into IP addresses.
- **DNS Server** — Contains a list of DNS servers. DNS servers are added in the **Add DNS Server** page.
- **Remove** — When selected, removes the selected DNS server.

Adding a DNS Server

1. Open the **Domain Name Server (DNS)** page.
2. Click **Add**.

The **Add DNS Server** page displays:

Figure 6-23. Add DNS Server

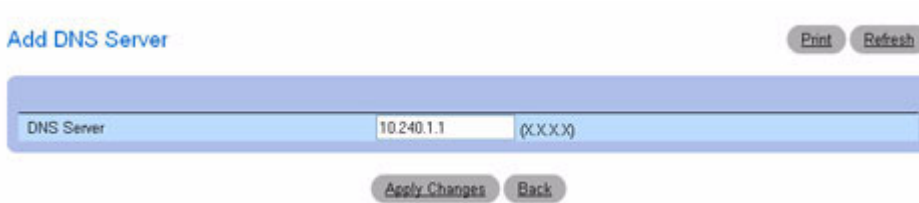

3. Define the relevant fields.
4. Click **Apply Changes**.
The new DNS server is defined, and the device is updated.

Configuring DNS Servers Using CLI Commands

For information about the CLI commands that perform this function, see the IP Addressing Commands chapter in the *CLI Reference Guide*. The following table summarizes the equivalent CLI commands you use to configure DNS servers.

Table 6-15. DNS Servers Commands

CLI Command	Description
ip domain-lookup	Use to enable IP DNS-based host name-to-address translation.
ip name-server	Configures available name servers.

Default Domain Name

Use the **Default Domain Name** page to view and define default DNS domain names.

To display the **Default Domain Name** page, click **System** → **IP Addressing** → **Default Domain Name**.

Figure 6-24. Default Domain Name

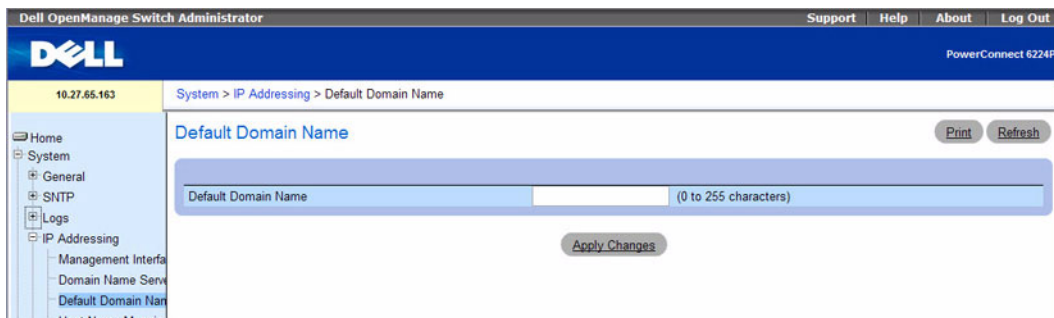

The **Default Domain Name** page contains the following field:

- **Default Domain Name (0–255 characters)** — Contains the user-defined default domain name. When configured, the default domain name is applied to all unqualified host names.

Defining DNS Domain Names Using CLI Commands

For information about the CLI commands that perform this function, see the IP Addressing Commands chapter in the *CLI Reference Guide*. The following table summarizes the equivalent CLI commands you use to define DNS domain names.

Table 6-16. DNS Domain Names Commands

CLI Command	Description
ip domain-name	Use to define a default domain name to complete unqualified host names.

Host Name Mapping

Use the **Host Name Mapping** page to assign an IP address to a static host name. The **Host Name Mapping** page provides one IP address per host.

To display the **Host Name Mapping** page, click **System** → **IP Addressing** → **Host Name Mapping**.

Figure 6-25. Host Name Mapping

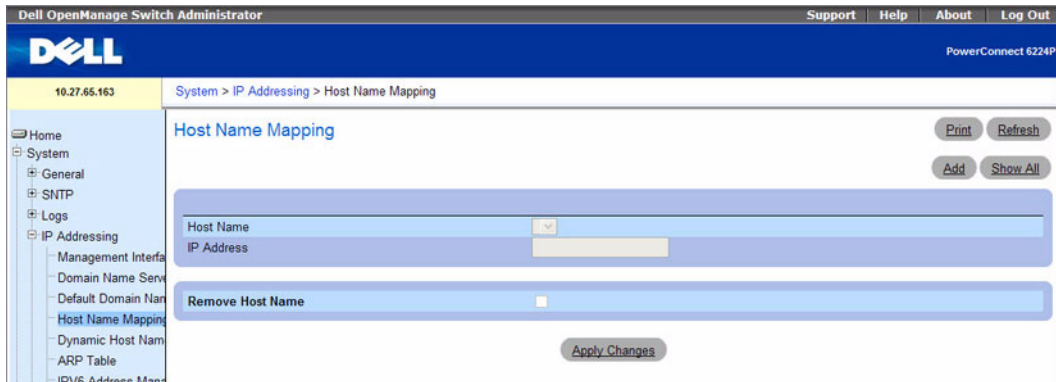

The **Host Name Mapping** page contains the following fields:

- **Host Name** — Contains a list of host names. Host names are defined on the **Add Static Host Name Mapping** page. Each host provides one IP address.
- **IP Address** — Provides an IP address that is assigned to the specified host name.
- **Remove Host Name** — Removes the host name IP mapping when checked.

Adding Host Domain Names

1. Open the Host Name Mapping page.
2. Click Add.

The Add Static Host Name Mapping page displays:

Figure 6-26. Add Static Host Name Mapping

Add Static Host Name Mapping Print Refresh

Host Name (0 - 255 characters)	DELL
IP Address	10.25.0.4 (x.x.x.x)

Apply Changes Back

3. Define the relevant fields.
4. Click Apply Changes.
The IP address is mapped to the host name, and the device is updated.

Displaying the Static Host Name Mapping Table

1. Open the Host Name Mapping page.
2. Click Show All.

The Static Host Name Mapping Table displays:

Figure 6-27. Static Host Name Mapping Table

Static Hosts Name Mapping Table Print Refresh

Host Name	IP Address	Remove	
1	dell.	10.25.0.4	<input type="checkbox"/> Edit

Previous Next

Apply Changes Back

Removing a Host Name From IP Address Mapping

1. Open the Host Name Mapping page.
2. Click Show All.

The Host Name Mapping Table opens.

3. Select a Host Name Mapping Table entry.
4. Check the **Remove** check box.
5. Click **Apply Changes**.

The Host Name Mapping Table entry is removed, and the device is updated.

Mapping an IP Address to Domain Host Names Using CLI Commands

For information about the CLI commands that perform this function, see the IP Addressing Commands chapter in the *CLI Reference Guide*. The following table summarizes the equivalent CLI commands you use.

Table 6-17. Host Name Mapping Command

CLI Command	Description
ip host	Use to configure static host name-to-address mapping in the host cache.

Dynamic Host Name Mapping

Use the Dynamic Host Name Mapping page to view dynamic host entries the switch has learned.

To display the Dynamic Host Name Mapping page, click **System** → **IP Addressing** → **Dynamic Host Name Mapping** in the tree view.

Figure 6-28. Dynamic Host Name Mapping

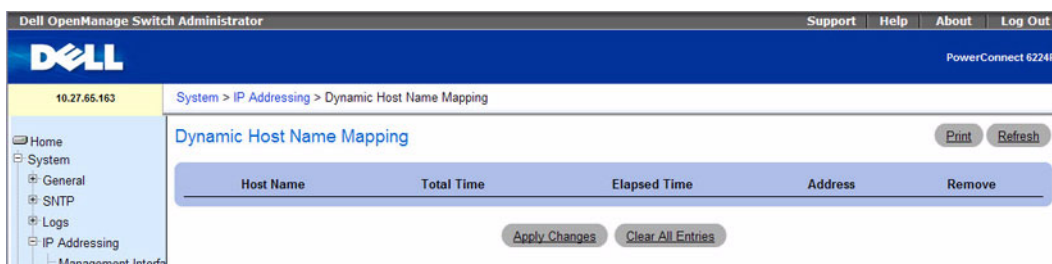

The Dynamic Host Name Mapping page contains the following fields:

- **Host Name** — Contains a list of host names.
- **Total Time** — Total time of the dynamic entry.
- **Elapsed Time** — Elapsed time of the dynamic entry.
- **Address** — IP address of dynamic entry.
- **Remove** — Select the entry to remove from the table, and then click **Apply Changes** to remove the selected entry from the Host Name IP Mapping list.

Click **Clear All Entries** to remove all Host Name IP Mapping entries from the table.

Viewing Dynamic Host Entries Using CLI Commands

For information about the CLI commands that perform this function, see the IP Addressing Commands chapter in the *CLI Reference Guide*. The following table summarizes the equivalent CLI commands you use.

Table 6-18. Dynamic Host Entries Commands

CLI Command	Description
show hosts	Displays dynamic host entries that the switch has learned.

ARP Table

Use the **ARP Table** page to view ARP parameters for IP interfaces. The ARP table displays the correlation between each MAC address and its corresponding IP address.

To display the **ARP Table** page, click **System** → **IP Addressing** → **ARP** in the tree view.

Figure 6-29. ARP Table

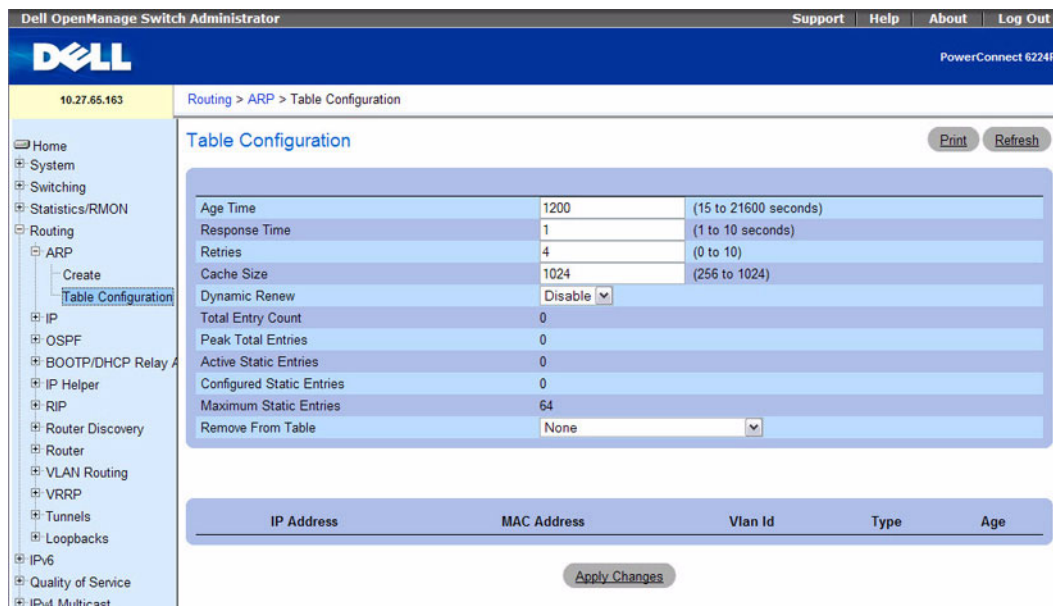

The **ARP Table** page contains the following fields:

- **IP Address** — The station IP address, which is associated with the MAC address filled in below.
- **MAC Address** — The station MAC address, which is associated in the ARP table with the IP address.

Viewing the ARP Table Using CLI Commands

For information about the CLI commands that perform this function, see the IP Addressing Commands chapter in the *CLI Reference Guide*. The following table summarizes the equivalent CLI commands you use.

Table 6-19. ARP Table Commands

CLI Command	Description
show arp switch	Use to display the entries in the ARP table.

IPv6 Management Features

The PowerConnect 6200 Series switch software includes several enhancements to the IPv6 management feature. You can assign either an IPv4 or IPv6 address to the management interface. In previous software releases, the management port supported IPv6 addresses, but only when the switch received its IPv6 addressing and gateway definitions through auto-configuration when connected to an IPv6 router on the management network. Support for host name mapping to a host with an IPv6 address is also present.

To display the IPv6 Management Interface page, click **System** → **IP Addressing** → **IPv6 Address Management** in the tree view.

Figure 6-30. IPv6 Address Management

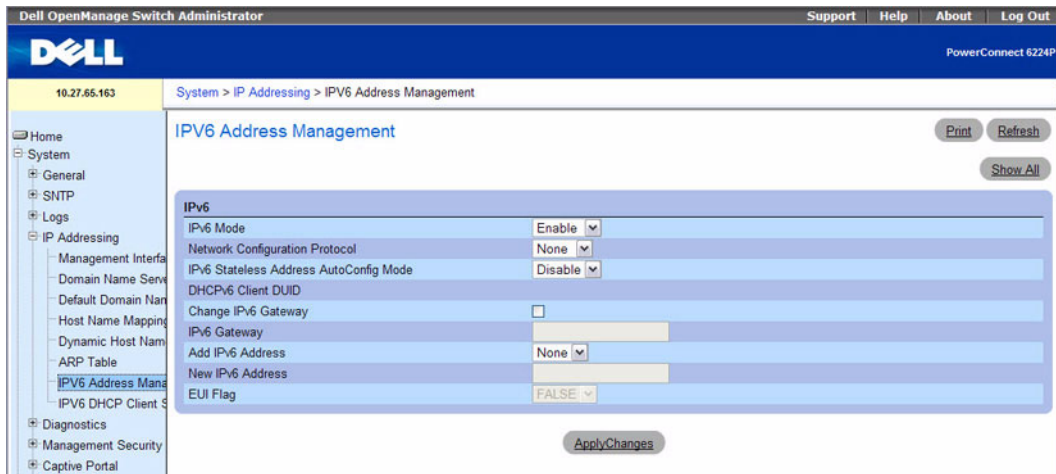

The IPv6 Address Management page contains the following fields:

- **IPv6 Mode** — Enables or disables IPv6 mode on the management interface.
- **Network Configuration Protocol** — Specify whether to use DHCP for dynamic IPv6 address assignment. If you select None, you can configure a static IPv6 address.

- **IPv6 Stateless Address AutoConfig Mode** — Enable or disable IPv6 auto address configuration on the interface. When IPv6 AutoConfig Mode is enabled, automatic IPv6 address configuration and gateway configuration is allowed by processing the Router Advertisements received on the management interface.
- **DHCPv6 Client DUID** — This is a read-only field that contains a unique ID generated from the MAC address when the DHCPv6 client is enabled. To get the value for this field, set the network protocol to DHCP.
- **Change IPv6 Gateway** — Select this option to allow the IPv6 Gateway field to be edited.
- **IPv6 Gateway** — Enter the IPv6 gateway address (do not include a prefix). Use an IPv6 global or link-local address format.
- **Add IPv6 Address** — To add an IPv6 address, select Add so you can specify an address in the New IPv6 Address field.
- **New IPv6 Address** — If Add is selected from the Add IPv6 Address field, enter an IPv6 prefix/length in this field.
- **EUI Flag** — Select True if the last 64 bits are to be derived from the MAC address. For example, you can enter 2001::/64 and have the EUI Flag (True) use the 64-bit address calculated from the MAC address.

Displaying IPv6 Address Management Information

1. Open the IPv6 Address Management page.
2. Click Show All to display the IPv6 Management Summary page.

Figure 6-31. IPv6 Management Summary

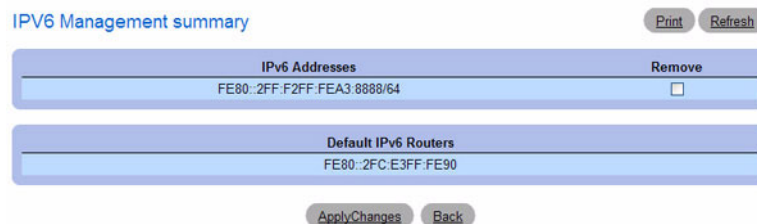

3. To remove an IPv6 Address, select the Remove option associated with the address, and click Apply Changes.

Viewing IPv6 Management Information Using CLI Commands

For information about the CLI commands that perform this function, see the IP Addressing Commands chapter in the *CLI Reference Guide*. The following table summarizes the equivalent CLI commands you use.

Table 6-20. Ipv6 Management Information Commands

CLI Command	Description
ipv6 address	Use to display the entries in the ARP table.
ipv6 enable	Enables IPv6 on the management interface.
ipv6 gateway	Configures an IPv6 gateway for the management interface.

Running Cable Diagnostics

Use the **Diagnostics** menu page to perform virtual cable tests for copper and fiber optics cables.

To display the **Diagnostics** page, click **System** → **Diagnostics** in the tree view.

Use this page to go to the following feature:

- **Integrated Cable Test for Copper Cables**
- **Optical Transceiver Diagnostics**

Integrated Cable Test for Copper Cables

Use the **Integrated Cable Test for Copper Cables** page to perform tests on copper cables. Cable testing provides information about where errors occurred in the cable, the last time a cable test was performed, and the type of cable error which occurred. The tests use Time Domain Reflectometry (TDR) technology to test the quality and characteristics of a copper cable attached to a port. Cables up to 120 meters long can be tested. Cables are tested when the ports are in the down state, with the exception of the **Approximated Cable Length** test.

To display the **Integrated Cable Test for Copper Cables** page, click **System** → **Diagnostics** → **Integrated Cable Test** in the tree view.

Figure 6-32. Integrated Cable Test for Copper Cables

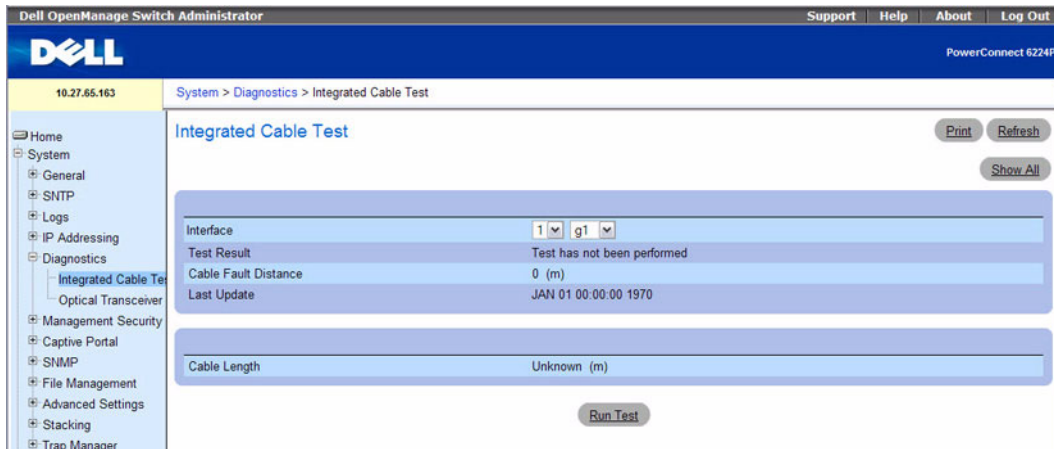

The **Integrated Cable Test for Copper Cables** page contains the following fields:

- **Interface** — The interface to which the cable is connected.
- **Test Result** — The cable test results. Possible values are:
 - **No Cable** — There is not a cable connected to the port.
 - **Open Cable** — The cable is open.
 - **Short Cable** — A short has occurred in the cable.
 - **OK** — The cable passed the test.
 - **Fiber Cable** — A fiber cable is connected to the port.
- **Cable Fault Distance** — The distance from the port where the cable error occurred.
- **Last Update** — The last time the port was tested.
- **Cable Length** — The approximate cable length. This test can only be performed when the port is up and operating at 1 Gbps.

Performing a Cable Test

1. Ensure that both ends of the copper cable are connected to a device.
2. Open the **Integrated Cable Test for Copper Cables** page.
3. Click **Run Test**.

The copper cable test is performed, and the results are displayed on the **Integrated Cable Test for Copper Cables** page.

Displaying Integrated Cable Test Results Table

1. Open the **Integrated Cable Test for Copper Cables** page.

2. Click Show All.
3. Select the desired unit from the drop-down menu.

The web page displays the **Integrated Cable Test Results Table** page showing the results of previous tests for every port on the selected unit.

Figure 6-33. Integrated Cable Test Results Table

Interface	Test Result	Cable Fault Distance (m)	Last Update	Cable Length (m)
1/xg1	OK	0	JAN 11 07:43:13 2031	12 - 47
1/xg2	OK	0	JAN 11 07:44:06 2031	12 - 51
1/xg3	Short Cable	12	JAN 11 07:44:35 2031	
1/xg4	Short Cable	12	JAN 11 07:53:18 2031	
1/xg5	Test has not been performed	0	JAN 01 00:00:00 1970	Unknown
1/xg6	Test has not been performed	0	JAN 01 00:00:00 1970	Unknown
1/xg7	Test has not been performed	0	JAN 01 00:00:00 1970	Unknown
1/xg8	Test has not been performed	0	JAN 01 00:00:00 1970	Unknown
1/xg9	Test has not been performed	0	JAN 01 00:00:00 1970	Unknown
1/xg10	Test has not been performed	0	JAN 01 00:00:00 1970	Unknown
1/xg11	Test has not been performed	0	JAN 01 00:00:00 1970	Unknown
1/xg12	Test has not been performed	0	JAN 01 00:00:00 1970	Unknown
1/xg13	Test has not been performed	0	JAN 01 00:00:00 1970	Unknown
1/xg14	Test has not been performed	0	JAN 01 00:00:00 1970	Unknown
1/xg15	Test has not been performed	0	JAN 01 00:00:00 1970	Unknown

Optical Transceiver Diagnostics

Use the **Optical Transceiver Diagnostics** page to perform tests on Fiber Optic cables.

To display the **Optical Transceiver Diagnostics** page, click **System** → **Diagnostics** → **Optical Transceiver Diagnostics** in the tree view.

 **NOTE:** Optical transceiver diagnostics can be performed only when the link is present.

Figure 6-34. Optical Transceiver Diagnostics



The Optical Transceiver Diagnostics page contains the following fields:

- **Interface** — The port IP address on which the cable is tested.
- **Temperature** — The temperature (C) at which the cable is operating.
- **Voltage** — The voltage at which the cable is operating.
- **Current** — The current at which the cable is operating.
- **Output Power** — The rate at which the output power is transmitted.
- **Input Power** — The rate at which the input power is transmitted.
- **Transmitter Fault** — Indicates if a fault occurred during transmission.
- **Loss of Signal** — Indicates if a signal loss occurred in the cable.
- **Data Ready** — Indicates the transceiver has achieved power up and data is ready.

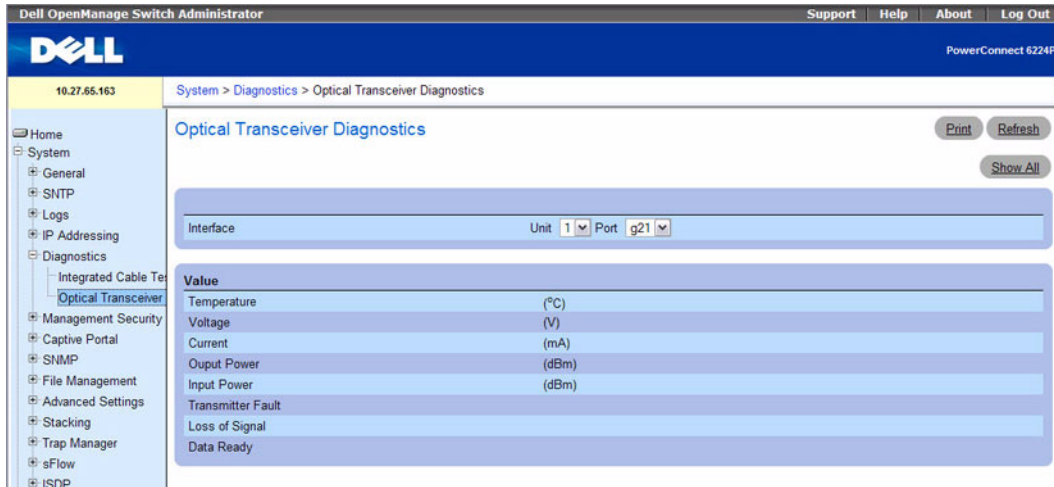
NOTE: Finisar transceivers do not support the transmitter fault diagnostic testing. Fiber Optic analysis feature works only on SFPs that support the digital diagnostic standard SFF-4872.

Displaying Optical Transceiver Diagnostics Test Results Table

1. Open the Optical Transceiver Diagnostics page.
2. Click Show All.
3. Select the desired unit from the drop-down menu.

Figure 6-35. Optical Transceiver Diagnostics Table

Interface	Temperature (°C)	Voltage (V)	Current (mA)	Output Power (dBm)	Input Power (dBm)	Transmitter Fault	Loss of Signal
1/xg1	0.0	0.000	0.0	-40.000	-40.000	FALSE	FALSE
1/xg2	43.3	3.299	5.6	-4.920	-24.815	FALSE	TRUE
1/xn3	0.0	0.000	0.0	-40.000	-40.000	FALSE	FALSE

The test runs and displays the Optical Transceiver Diagnostics Table page.

Performing Fiber Optic Cable Tests Using CLI Commands

For information about the CLI commands that perform this function, see the PHY Diagnostics Commands chapter in the *CLI Reference Guide*. The following table summarizes the equivalent CLI commands you use to perform cable tests.

Table 6-21. Cable Tests Commands

CLI Command	Description
show copper-ports cable-length	Use to display the estimated copper cable length attached to a port.
show copper-ports-tdr	Use to display the last TDR (Time Domain Reflectometry) tests on specified ports.
show fiber-ports optical-transceiver	Use to display the optical transceiver diagnostics.
test copper-port tdr	Use to diagnose with TDR technology the quality and characteristics of a copper cable attached to a port.

Managing Device Security

Use the **Management Security** menu page to set management security parameters for port, user, and server security.

To display the **Management Security** page, click **System** → **Management Security** in the tree view. Use this page to go to the following features:

- Access Profile
- Authentication Profiles
- Select Authentication
- Password Management
- Local User Database
- Line Passwords
- Enable Password
- TACACS+ Settings
- RADIUS Global Configuration
- RADIUS Server Configuration
- RADIUS Accounting Server Statistics
- RADIUS Server Statistics
- Authorization Network RADIUS
- Telnet Server
- Denial of Service

Access Profile

Use the **Access Profile** page to define a profile and rules for accessing the device. You can limit access to specific management functions, to specific ingress interfaces, and/or to source IP address and/or source IP subnets. The feature has been modified to include TFTP in the list of management access methods.

Management access can be separately defined for each type of management access method, including, Web (HTTP), Secure web (HTTPS), Telnet, SSH, TFTP, and SNMP.

To display the **Access Profile** page, click **System** → **Management Security** → **Access Profiles** in the tree view.

When you add a profile or a rule from the **Access Profile** page, the Management Method field on the **Add Profile** and **Add Rule** pages now contains the TFTP option. Select the TFTP option to limit the user's access method to TFTP.

Figure 6-36. Access Profile

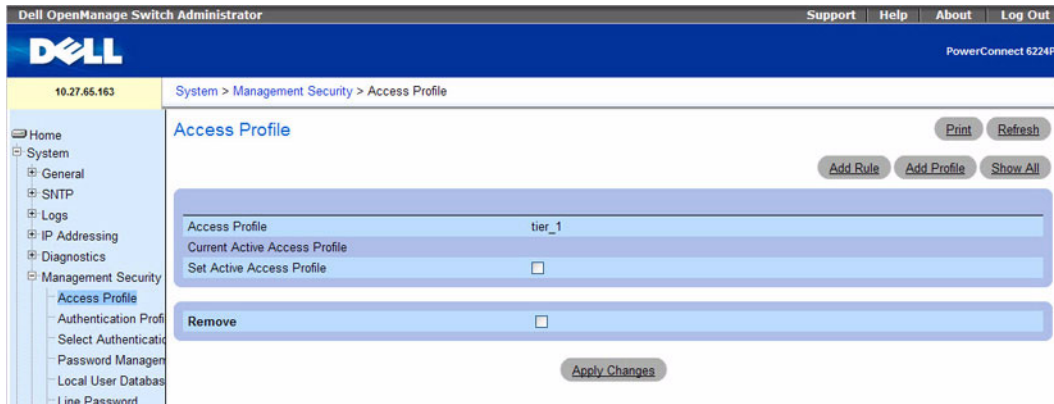

The Access Profile page contains the following fields:

- **Access Profile** — Shows the Access Profile.
- **Current Active Access Profile** — Shows profile that is activated.
- **Set Active Access Profile** — Activates the access profile.
- **Remove Profile** — When checked, removes an access profile from the Access Profile list.

 **NOTE:** Assigning an access profile to an interface implies that access through other interfaces is denied. If an access profile is not activated, the device can be accessed by all.

Displaying the Access Profile

1. Open the Access Profile page.
2. Click Show All to display the Profile Rules Table page.

Figure 6-37. Profile Rules Table

Profile Rules Table Print Refresh

Access Profile Name

	Interface	Management Method	Source IP Address	Subnet Mask	Action	Priority	Remove
1	1/xg1	SNMP	132.25.39.115	255.255.255.255	PERMIT	1	<input type="checkbox"/> Edit
2	1/xg12	SSH	192.168.22.15	255.255.255.255	PERMIT	3	<input type="checkbox"/> Edit

Apply Changes Back

Adding an Access Profile

1. Open the Access Profile page.
2. Click Add Profile.

The Add an Access Profile page displays.

Figure 6-38. Add an Access Profile

Add an Access Profile Print Refresh

Access Profile Name(1-32 characters)

Management Method

Interface

Source IP Address Network Mask Prefix Length (0-32)

Action

Rule Priority (1-64)

Apply Changes Back

3. Enter the profile name in the Access Profile Name text box.
4. Complete the fields:

Management Method — Select from the dropdown box. The policy is restricted by the management chosen.

Interface — Choose the check box for the interface if the policy should have a rule based on the interface. Interface can be a physical interface, a LAG, or a VLAN.

Source IP Address — Select the **Source IP Address** check box if the policy should have a rule based on the IP address of the client sending the management traffic. Fill in the source IP address and mask details in the fields provided. Note that Mask can be given in two formats: either dotted IP format (for example, 255.255.255.0) or prefix length (for example, 32)

Action — Choose the action to be performed when the rules selected above are matched. Use the dropdown box and choose Permit or Deny to permit or deny access.

Rule Priority — Configure priorities to the rules. The rules are validated against the incoming management request in the ascending order of their priorities. If a rule matches, action is performed and rules below are ignored. For example, if you configure Source IP 10.10.10.10 with priority 1 to Permit, and configure Source IP 10.10.10.10 with priority 2 to Deny, then access is permitted if the profile is active, and the second rule is ignored.

5. Click Apply Changes.

The new access profile is added, and the device is updated.

Activating an Access Profile

1. Open the **Access Profile** page.
2. Check **Set Access Profile Active**.
3. Click **Apply Changes**.

The access profile is enabled for the device.

Adding Rules to an Access Profile

1. Open the **Access Profile** page.

The **Access Profile** field shows the profile to which rules are added when the **Add An Access Profile Rule** page is displayed.

2. Click **Add Rule**.

The **Add An Access Profile Rule** page displays.

Figure 6-39. Add An Access Profile Rule

Add an Access Profile Rule Print Refresh

Access Profile Name: No Profile Exists

Management Method: NONE

Interface: Unit 1, Port g1, LAG ch1, VLAN 1

Source IP Address (X.X.X.X):
 Network Mask (X.X.X.X)
 Prefix Length (0-32)

Action: Permit

Rule Priority (1-64): 0

Apply Changes Back

3. Complete the fields in the dialog:

Management Method — Select from the dropdown box. The policy is restricted by the management chosen.

Interface — Choose the check box for the interface if the policy should have a rule based on the interface. Interface can be a physical interface, a LAG, or a VLAN.

Source IP — Select the **Source IP Address** check box if the policy should have a rule based on the IP address of the client originating the management traffic. Fill in the source IP address and Mask details in the text boxes provided. Note that Mask can be given in two formats - either dotted IP format (for example, 255.255.255.0) or prefix length (for example, 32).

Action — Choose the action to be performed when the rules selected above are matched. Use the dropdown box and choose Permit or Deny to permit or deny access.

Rule Priority — Configure priorities to the rules. The rules are validated against the incoming management request in the ascending order of their priorities. If a rule matches, action is performed and rules below are ignored. For example, if you configure Source IP 10.10.10.10 with priority 1 to Permit, and configure Source IP 10.10.10.10 with priority 2 to Deny, then access is permitted if the profile is active, and the second rule is ignored.

4. Click **Apply Changes**.

The rule is added to the access profile, and the device is updated.

Removing a Rule

1. Open the **Access Profile** page.
2. Click **Show All** to display the **Profile Rules Table** page.
3. Select a rule.
4. Check the **Remove** check box.
5. Click **Apply Changes**.

The rule is removed, and the device is updated.

Defining Access Profiles Using CLI Commands

For information about the CLI commands that perform this function, see the **Management ACL Commands** chapter in the *CLI Reference Guide*. The following table summarizes the equivalent CLI commands you use to define access profiles.

Table 6-22. Access Profiles Commands

CLI Command	Description
management access-class	Defines which management access-list is used.
management access-list	Defines a management access-list, and enters the access-list for configuration.
permit (management)	Defines a permit rule.
show management access-class	Displays the active management access-list.
show management access-list	Displays management access-lists.

Authentication Profiles

User authentication occurs locally and on an external server. Use the **Authentication Profiles** page to select the user authentication method on the device.

To display the **Authentication Profiles** page, click **System** → **Management Security** → **Authentication Profiles** in the tree view.

Figure 6-40. Authentication Profiles

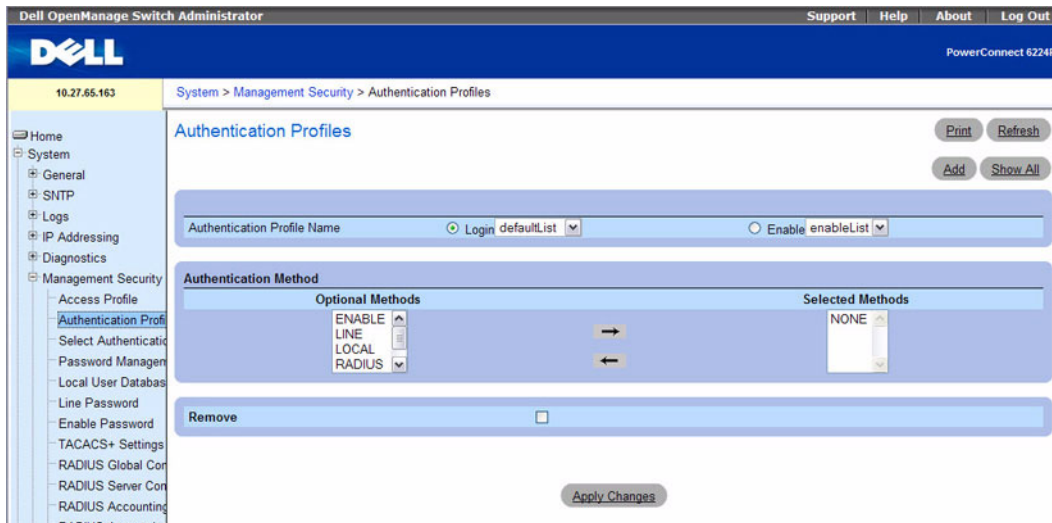

The **Authentication Profiles** page contains the following fields:

Authentication Profile Name

Displays lists to which user-defined authentication profiles are added. Use the radio buttons to apply the authentication profile to govern either Login or Enable part of the switch's operations, and to select one of two available lists:

- **Login** — Allows you to login to the switch. Options are **defaultList**, **networkList** and any user-defined login authentication profiles.
- **Enable** — Enables privilege mode.

Authentication Method

- **Optional Methods** — User authentication methods. Possible options are:
 - **None** — No user authentication occurs.
 - **Local** — User authentication occurs at the device level; the device checks the user name and password for authentication.
 - **RADIUS** — User authentication occurs at the RADIUS server. For more information about RADIUS servers, see "RADIUS Global Configuration."
 - **TACACS+** — User authentication occurs at the TACACS+ server. For more information about TACACS+ servers, see "TACACS+ Settings."
 - **Line** — The line password is used for user authentication.
 - **Enable** — The enable password is used for authentication.

 **NOTE:** User authentication occurs in the order the methods are selected. If an error occurs during the authentication, the next selected method is used. For example, if **Local** then **RADIUS** options are selected, the user is authenticated first locally and then through an external **RADIUS** server.

- **Selected Methods** — The selected authentication method.
- **Remove** — Removes the selected profile.

Adding an Authentication Profile

1. Open the **Authentication Profiles** page.
2. Click **Add** to display the **Add Authentication Profile** page.

Figure 6-41. Add Authentication Profile



Add Authentication Profiles Print Refresh

Login Enable

Profile Name(1-12 characters)

Authentication Method

Optional Methods		Selected Methods
ENABLE	→	LINE
LOCAL		NONE
RADIUS	←	
TACACS		

Apply Changes Back

3. Enter the profile name of 1 to 12 characters in the **Profile Name** field.

 **NOTE:** The profile name should not include spaces.

4. Click **Apply Changes**.

A profile is created. You can activate an authentication profile using the **System** → **Management Security** → **Select Authentication** web page.

Modifying Authentication Profiles

1. Open the **Authentication Profiles** page.
2. Select an element from the list in the **Authentication Profile Name** field.
3. Select one or more **Optional Methods** by using the arrows.
4. Click **Apply Changes**.

The user authentication profile is updated to the device.

Removing an Authentication Profiles Entry

1. Open the **Authentication Profiles** page.
2. Click **Show All**.

The **Authentication Profiles** Table opens.

Figure 6-42. Authentication Profiles Table

Authentication Profiles Table Print Refresh

Login Authentication Profiles		Methods	Remove
1	defaultList	NONE,LINE	<input type="checkbox"/> Edit

Enable Authentication Profiles		Methods	Remove
1	enableList	NONE	<input type="checkbox"/> Edit
2	R&D	LINE,NONE	<input type="checkbox"/> Edit

Apply Changes Back

3. Check the **Remove** check box next to the profile to be removed.
4. Click **Apply Changes**.

The entry is removed.

Configuring an Authentication Profile Using CLI Commands

For information about the CLI commands that perform this function, see the *AAA Commands* chapter in the *CLI Reference Guide*. The following table summarizes the equivalent CLI commands you use.

Table 6-23. Authentication Profile Configuration Commands

CLI Command	Description
aaa authentication enable	Sets authentication for accessing higher privilege levels.
aaa authentication login	Defines login authentication.
enable authentication	Specifies the authentication method list when accessing a higher privilege level from a remote telnet or console.
show authentication methods	Shows information about authentication methods.

Select Authentication

After authentication profiles are defined, you can apply them to management access methods. For example, console users can be authenticated by Authentication Profile List 1, while Telnet users are authenticated by Authentication Profile List 2.

To display the Select Authentication page, click **System** → **Management Security** → **Select Authentication** in the tree view.

Figure 6-43. Select Authentication

The screenshot shows the Dell OpenManage Switch Administrator interface. The breadcrumb path is System > Management Security > Select Authentication. The page title is "Select Authentication". There are "Print" and "Refresh" buttons in the top right. The left sidebar shows a tree view with "Management Security" expanded to "Select Authentication". The main content area has several sections:

- Console:** Login: defaultList, Enable: enableList
- Telnet:** Login: tlList, Enable: tlList
- Secure Telnet (SSH):** Login: networkList, Enable: eList
- Secure HTTP:** Optional Methods: RADIUS, TACACS, NONE; Selected Methods: LOCAL
- HTTP:** Optional Methods: RADIUS, TACACS, NONE; Selected Methods: LOCAL

At the bottom center is an "Apply Changes" button.

The Select Authentication page contains the following fields:

- **Console** — Authentication profiles used to authenticate console users.
- **Telnet** — Authentication profiles used to authenticate Telnet users.
- **Secure Telnet (SSH)** — Authentication profiles used to authenticate Secure Shell (SSH) users. SSH provides clients secure and encrypted remote connections to a device.
- **Secure HTTP and HTTP** — Authentication method used for Secure HTTP access and HTTP access, respectively. Possible field values are:
 - **None** — No authentication method is used for access.
 - **Local** — Authentication occurs locally.
 - **RADIUS** — Authentication occurs at the RADIUS server.

- **TACACS+** — Authentication occurs at the TACACS+ server.
- **Local, None** — Authentication first occurs locally.
- **RADIUS, None** — Authentication first occurs at the RADIUS server. If authentication cannot be verified, no authentication method is used. Authentication cannot be verified if the remote server cannot be contacted to verify the user. If the remote server can be contacted, then the response from the remote server is always honored.
- **TACACS+, None** — Authentication first occurs at the TACACS+ server. If authentication cannot be verified, no authentication method is used. Authentication cannot be verified if the remote server cannot be contacted to verify the user. If the remote server can be contacted, then the response from the remote server is always honored.
- **Local, RADIUS** — Authentication first occurs locally. If authentication cannot be verified locally, the RADIUS server authenticates the management method. If the RADIUS server cannot authenticate the management method, the session is blocked.
- **Local, TACACS+** — Authentication first occurs locally. If authentication cannot be verified locally, the TACACS+ server authenticates the management method. If the TACACS+ server cannot authenticate the management method, the session is blocked.
- **RADIUS, Local** — Authentication first occurs at the RADIUS server. If authentication cannot be verified at the RADIUS server, the session is authenticated locally. If the session cannot be authenticated locally, the session is blocked.
- **TACACS+, Local** — Authentication first occurs at the TACACS+ server. If authentication cannot be verified at the TACACS+ server, the session is authenticated locally. If the session cannot be authenticated locally, the session is blocked.
- **Local, RADIUS, None** — Authentication first occurs locally. If authentication cannot be verified locally, the RADIUS server authenticates the management method. If the RADIUS server cannot authenticate the management method, the session is permitted.
- **RADIUS, Local, None** — Authentication first occurs at the RADIUS server. If authentication cannot be verified at the RADIUS server, the session is authenticated locally. If the session cannot be authenticated locally, the session is permitted.
- **Local, TACACS+, None** — Authentication first occurs locally. If authentication cannot be verified locally, the TACACS+ server authenticates the management method. If the TACACS+ server cannot authenticate the management method, the session is permitted.
- **TACACS+, Local, None** — Authentication first occurs at the TACACS+ server. If authentication cannot be verified at the TACACS+ server, the session is authenticated locally. If the session cannot be authenticated locally, the session is permitted.

Using a RADIUS Server for Authentication

If you use a RADIUS server to authenticate users, you must configure user attributes in the user database on the RADIUS server. The user attributes include the user name, password, and privilege level.



NOTE: To set the privilege level, use the Service-Type attribute. Do not use any vendor-specific attribute value pairs.

The following example shows an entry in the `FreeRADIUS /etc/raddb/users` file that allows a user (name: *admin*) to log onto the switch with read/write privileges, which is equivalent to privilege level 15.

```
admin          Auth-Type := Local,
               User-Password == "pass1234"
               Service-Type = NAS-Prompt-User

enable        Auth-Type := Local,
               User-Password == "pass5678"
               Service-Type = Administrative-User
```

The values for the `Service-Type` attribute are as follows:

- `NAS-Prompt-User` indicates the user should be provided a command prompt on the NAS, from which nonprivileged commands can be executed.
- `Administrative-User` indicates the user should be granted access to the administrative interface to the NAS, from which privileged commands can be executed.

Applying an Authentication Method List to Console Sessions

1. Open the **Select Authentication** page.
2. Select an authentication profile in the **Console** field.
3. Click **Apply Changes**.
Console sessions are assigned an authentication method List.

Applying an Authentication Profile to Telnet Sessions

1. Open the **Select Authentication** page.
2. Select an authentication profile in the **Telnet** field.
3. Click **Apply Changes**.
Console sessions are assigned authentication profiles.

Applying an Authentication Profile to Secure Telnet (SSH) Sessions

1. Open the **Select Authentication** page.
2. Select an authentication profile in the **Secure Telnet (SSH)** field.
3. Click **Apply Changes**.
Secure Telnet (SSH) sessions are assigned authentication profiles.

Assigning HTTP Sessions an Authentication Sequence

1. Open the **Select Authentication** page.

2. Under **HTTP**, select an authentication method in the **Optional Methods** field and click the right arrow button.

The selected authentication method moves to the **Selected Methods** field.

3. Repeat until the desired authentication sequence is displayed in the **Selected Methods** field.

4. Click **Apply Changes**.

HTTP sessions are assigned the authentication sequence.

Assigning Access Methods, Authentication Profiles, or Sequences Using CLI Commands

For information about the CLI commands that perform this function, see the AAA Commands chapter in the *CLI Reference Guide*. The following table summarizes the equivalent CLI commands you use.

Table 6-24. Access Method and Authentication Profile Commands

CLI Command	Description
enable authentication	Specifies the authentication method list when accessing a higher privilege level from a remote telnet or console.
ip http authentication	Specifies authentication methods for http.
ip https authentication	Specifies authentication methods for https.
login authentication	Specifies the login authentication method list for a remote telnet or console.
show authentication methods	Shows information about authentication methods.

Assigning Secure HTTP Sessions an Authentication Sequence

1. Open the **Select Authentication** page.
2. Under **Secure HTTP**, select an authentication method in the **Optional Methods** field and click the right arrow button.

The selected authentication method moves to the **Selected Methods** field.

3. Repeat until the desired authentication sequence is displayed in the **Selected Methods** field.

4. Click **Apply Changes**.

Secure HTTP sessions are assigned the authentication sequence.

Password Management

Password management provides increased network security and improved password control. Passwords for SSH, Telnet, HTTP, HTTPS, and SNMP access are assigned security features, including:

- Defining minimum password lengths (the minimum password length is 8 when password length-checking is enabled)
- Password expiration

- Preventing frequent password reuse
- Locking out users out after failed login attempts

To display the **Password Management** page, click **System** → **Management Security** → **Password Management** in the tree view.

Figure 6-44. Password Management

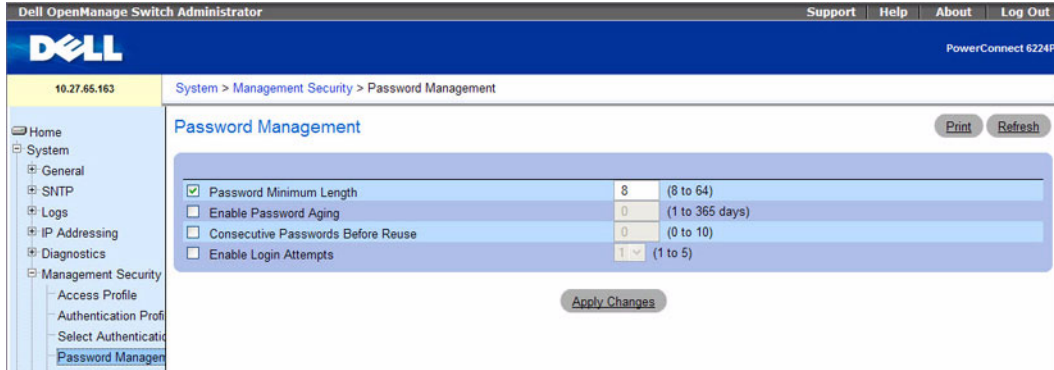

The **Password Management** page contains the following fields:

- **Password Minimum Length (8–64)** — Indicates the minimum password length, when checked. For example, the administrator can define that all line passwords must have at least 10 characters. If you clear the check box and apply the changes, no minimum password length is required. This means that users can be created without a password.
 - **Enable Password Aging (1–365)** — Indicates the amount of time that elapses before a password is aged out, when checked. The field value is from 1 to 365 days. The password aging feature functions only if the switch clock is synchronized to an SNTP server. See the "Clock Commands" section in the *CLI Reference Guide* for additional information.
 - **Consecutive Passwords Before Reuse (1–10)** — Indicates the amount of times a password is changed, before the password can be reused. The possible field values are 1 to 10.
- NOTE:** The user is notified to change the password prior to expiry. The Web users do not see this notification.
- **Enable Login Attempts (1–5)** — When selected, enables locking a user out of the device when a faulty password is used a defined number of times. For example, if the number of login attempts has been defined as five and the user attempts to log on five times with an incorrect password, the device locks the user out on the sixth attempt. When this happens, a super user must re-enable the user account. The field range is 1 to 5 attempts.

Defining Password Constraints

1. Open the **Password Management** page.
2. Define the relevant fields.

3. Click Apply Changes.

The password constraints are defined, and the device is updated.

Defining Password Constraints Using CLI Commands

For information about the CLI commands that perform this function, see the Password Management Commands chapter in the *CLI Reference Guide*. The following table summarizes the equivalent CLI commands you use.

Table 6-25. Password Constraints Commands

CLI Command	Description
passwords aging	Implements aging on the passwords such that users are required to change passwords when they expire.
passwords history	Enables the administrator to set the number of previous passwords that are stored to ensure that users do not reuse their passwords too frequently.
passwords lock-out	Enables the administrator to strengthen the security of the switch by enabling the user lockout feature. When a lockout count is configured, a user who is logging in must enter the correct password within that count.
passwords min-length	Enables the administrator to enforce a minimum length required for a password.
show passwords configuration	Displays the configuration parameters for password configuration.

Local User Database

Use the **Local User Database** page to define passwords, access rights for users and reactivate users whose accounts have been suspended.

To display the **Local User Database** page, click **System** → **Management Security** → **Local User Database** in the tree view.

Figure 6-45. Local User Database

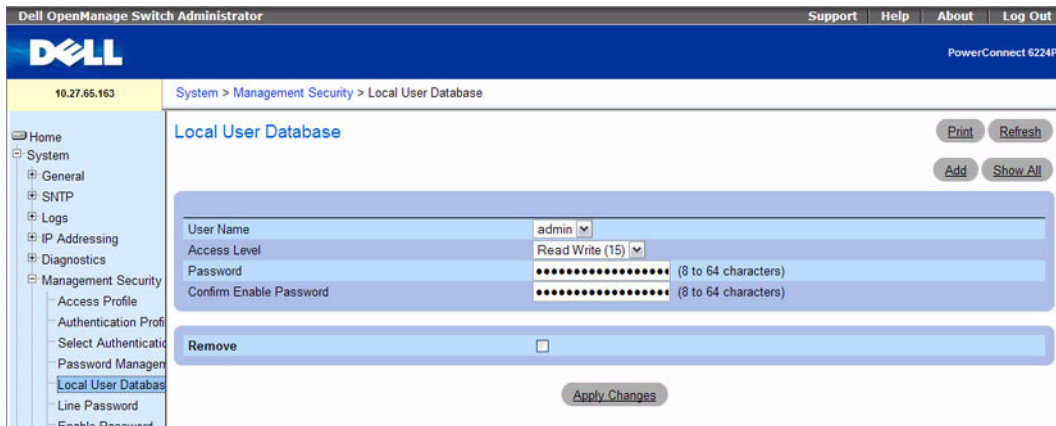

The Local User Database page contains the following fields:

- **User Name** — List of users.
- **Access Level** — User access level. The lowest user access level is 1 (readonly), and 15 (readwrite) is the highest. To suspend a user's access, set level to 0 (only a level 15 user has this ability).
- **Password (8– 64 characters)** — User-defined password.
- **Confirm Password** — Confirms the user-defined password.
- **Remove** — When selected, removes users from the local user database.

Assigning Access Rights to a User

1. Open the Local User Database page.
2. Select a user in the User Name field.
3. Define the fields as needed.
4. Click Apply Changes.

The user's access rights and passwords are defined, and the device is updated.

Adding a User to the Local User Database

1. Open the Local User Database page.
2. Click Add to display the Add User page.
The Add a New User page is displayed.

Figure 6-46. Add a New User

Attribute	Value
User Name (1 to 20 characters)	<input type="text"/>
Access Level	Read Write (15) ▼
Password (8 to 64 characters)	*****
Confirm Password (8-64 characters)	*****

3. Complete the fields.
4. Click **Apply Changes**.
The new user is defined, and the device is updated.

 **NOTE:** You can define as many as eight local users on the device.

Displaying Users on the Local User Database

1. Open the **Local User Database** page.
2. Click **Show All** to display the **Local User Table** page.
All members of the local user database are displayed.

Figure 6-47. Local User Table

	User Name	Access Level	Remove
1	amycover	Read Write	<input type="checkbox"/> Edit
2	hopekiser	Read Write	<input type="checkbox"/> Edit
3	hall	Read Write	<input type="checkbox"/> Edit

Removing Users From the Local User Database

1. Open the **Local User Database** page.
2. Click **Show All** to display the **Local User Table** page.
3. Select a **User Name**.
4. Check **Remove**.
5. Click **Apply Changes**.
The user is removed, and the device is updated.

Assigning Users With CLI Commands

For information about the CLI commands that perform this function, see the AAA Commands chapter in the *CLI Reference Guide*. The following table summarizes the equivalent CLI commands you use.

Table 6-26. Users Commands

CLI Command	Description
password	Specifies a user password
username	Establishes a username-based authentication system.
show user accounts	Displays information about the local user database.

Line Passwords

Use the **Line Password** page to define line passwords for management methods.

To display the **Line Password** page, click **System** → **Management Security** → **Line Password** in the tree view.

Figure 6-48. Line Password

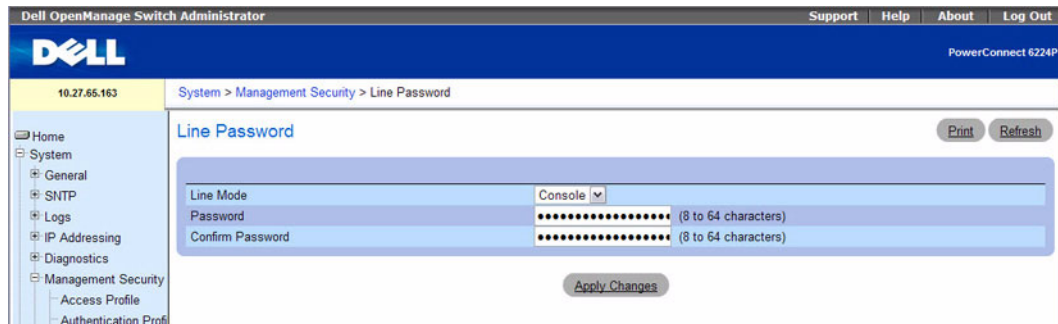

The **Line Password** page contains the following fields:

- **Line Mode** — Drop-down menu specifies device access through a Console, Telnet, or Secure Telnet (SSH) session.
- **Line Password (8 – 64 characters)** — The line password for accessing the device through a console, Telnet, or Secure Telnet session. The password appears in the ***** format.
- **Confirm Password (8 – 64 characters)** — Confirms the new line password. The password appears in the ***** format.

Defining Line Passwords

1. Open the **Line Password** page.
2. Select device access through a Console, Telnet, or Secure Telnet (SSH) session.

3. Define the **Line Password** field for the type of session you use to connect to the device.
4. Confirm the **Line Password**.
5. Click **Apply Changes**.

The line password for the type of session is defined, and the device is updated.

Assigning Line Passwords Using CLI Commands

For information about the CLI commands that perform this function, see the AAA Commands chapter in the *CLI Reference Guide*. The following table summarizes the equivalent CLI commands you use.

Table 6-27. Line Passwords Commands

CLI Command	Description
password	Specifies the password for a line (console, telnet, or SSH).

Enable Password

Use the **Enable Password** page to set a local password to control access to normal and privilege levels. To display the **Enable Password** page, click **System** → **Management Security** → **Enable Password** in the tree view.

Figure 6-49. Enable Password

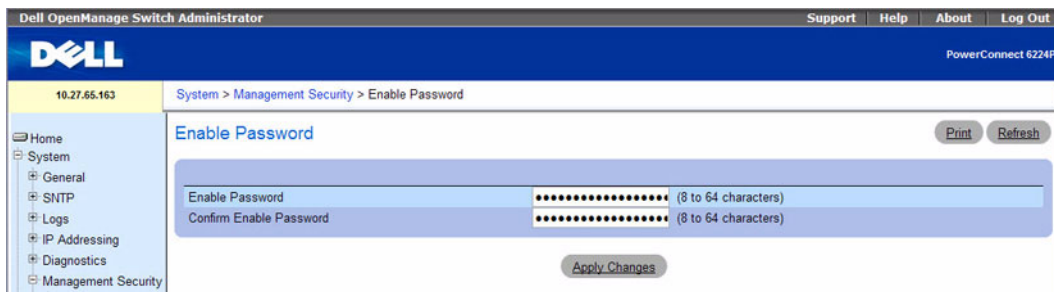

The **Enable Password** page contains the following fields:

- **Enable Password (8–64 characters)** — The Enable password for controlling access to normal and privilege levels. The password appears in the ***** format.
- **Confirm Enable Password** — Confirms the new Enable password. The password appears in the ***** format.

Defining Enable Passwords

1. Open the **Enable Password** page.
2. Specify the Enable password.

3. Confirm the Enable password.
4. Click **Apply Changes**.

The Enable password is set.

Defining Enable Passwords Using CLI Commands

For information about the CLI commands that perform this function, see the AAA Commands chapter in the *CLI Reference Guide*. The following table summarizes the equivalent CLI commands you use.

Table 6-28. Enable Passwords Commands

CLI Command	Description
enable password	Sets a local password to control access to the normal level.

TACACS+ Settings

The device provide Terminal Access Controller Access Control System (TACACS+) client support. TACACS+ provides centralized security for validation of users accessing the device.

TACACS+ provides a centralized user management system, while still retaining consistency with RADIUS and other authentication processes. TACACS+ provides the following services:

- **Authentication** — Provides authentication during login and through user names and user-defined passwords.
- **Authorization** — Performed at login. Once the authentication session is completed, an authorization session starts using the authenticated user name. The TACACS+ server checks the user privileges.

The TACACS+ protocol ensures network security through encrypted protocol exchanges between the device and TACACS+ server.

The **TACACS+ Settings** page contains both user-defined and the default TACACS+ settings for the inband management port.

To display the **TACACS+ Settings** page, click **System** → **Management Security** → **TACACS+** in the tree view.

Figure 6-50. TACACS+ Settings

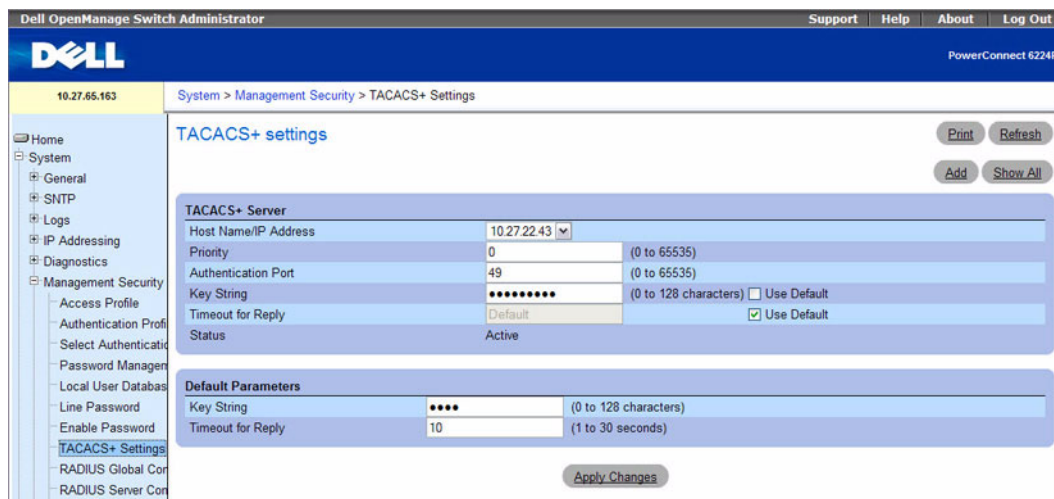

The TACACS+ Settings page contains the following fields:

- **Host Name / IP Address** — Specifies the TACACS+ Server.
- **Priority (0–65535)** — Specifies the order in which the TACACS+ servers are used. The default is 0.
- **Authentication Port (0–65535)** — The port number through which the TACACS+ session occurs. The default is port 49.
- **Key String (0–128 Characters)** — Defines the authentication and encryption key for TACACS+ communications between the device and the TACACS+ server. This key must match the encryption used on the TACACS+ server. Check **Use Default** to use the default value.
- **Timeout for Reply (1–30)** — The amount of time that passes before the connection between the device and the TACACS+ server times out. The field range is from 1 to 30 seconds. Check **Use Default** to select the factory-default value.
- **Status** — The connection status between the device and the TACACS+ server. The possible field values are:
 - **Connected** — There is currently a connection between the device and the TACACS+ server.
 - **Not Connected** — There is not currently a connection between the device and the TACACS+ server.

The fields in the Default Parameters section of the page contain values that are automatically applied to new TACACS+ servers.

- **Key String (0–128 Characters)** — Enter the default authentication and encryption key for TACACS+ communication between the device and the TACACS+ server.

- **Timeout for Reply (1–30)** — Enter the global user configuration time that passes before the connection between the device and the TACACS+ times out.

Defining TACACS+ Parameters

1. Open the TACACS+ Settings page.
2. Define the fields as needed.
3. Click Apply Changes.

The TACACS+ settings are updated to the device.

Adding a TACACS+ Server

1. Open the TACACS+ Settings page.
2. Click Add.

The Add TACACS+ Host page displays.

Figure 6-51. Add TACACS+ Host

Add TACACS+ Host		
Host Name/IP Address	10.240.13.45	(X.X.X.X)
Priority (0 - 65535)	258	
Authentication Port (0 - 65535)	43	
Key String (0 - 128 characters)	*****	<input type="checkbox"/> Use Default
Timeout for Reply (1 - 30)	5	(sec) <input type="checkbox"/> Use Default

3. Define the fields as needed.
 4. Click Apply Changes.
- The TACACS+ server is added, and the device is updated.

Displaying a TACACS+ Servers List

1. Open the TACACS+ Settings page.
2. Click Show All.

The TACACS+ Servers Table opens.

Figure 6-52. TACACS+ Servers Table

	Host IP Address	Priority	Authentication Port	Timeout For Reply (sec)	Status	Remove
1	10.240.13.45	258	43	5	Not Connected	<input type="checkbox"/> Edit

Removing a TACACS+ Server from the TACACS+ Servers List

1. Open the TACACS+ Settings page.
2. Click Show All.
The TACACS+ Servers Table opens.
3. Select a TACACS+ Servers Table entry.
4. Select the Remove check box.
5. Click Apply Changes.

The TACACS+ server is removed, and the device is updated.

Configuring TACACS+ Servers Using CLI Commands

For information about the CLI commands that perform this function, see the TACACS+ Commands chapter in the *CLI Reference Guide*. The following table summarizes the equivalent CLI commands you use.

Table 6-29. TACACS+ Servers Commands

CLI Command	Description
key	Specifies the authentication and encryption key for all TACACS communications between the device and the TACACS server.
port	Specifies a server port number.
priority	Specifies the order in which servers are used.
show tacacs	Displays TACACS+ server settings and statistics.
tacacs-server host	Specifies a TACACS+ server host.
tacacs-server key	Sets the authentication and encryption key for all TACACS+ communications between the switch and the TACACS+ daemon.
tacacs-server timeout	Sets the interval for which the switch waits for a server host to reply.
timeout	Specifies the timeout value in seconds.

RADIUS Global Configuration

The Remote Authorization Dial-In User Service (RADIUS) client on the PowerConnect 6200 Series switch supports multiple, named RADIUS servers. The RADIUS authentication and accounting server groups can contain one or more configured authentication servers that share the same RADIUS server name.

If you configure multiple RADIUS servers with the same RADIUS Server Name, designate one server as the primary and the other(s) as the backup server(s). The switch attempts to use the primary server first, and if the primary server does not respond, the switch attempts to use one of the backup servers with the same RADIUS Server Name.

The software also supports RADIUS Attribute 4, which is the configuration of a NAS-IP Address. The network access server (NAS) IP address is only used in Access-Request packets.

In some networks, the RADIUS server is responsible for assigning traffic to a particular VLAN. The RADIUS enhancements include the Authorization Network RADIUS feature that allows the switch to accept VLAN assignment by the RADIUS server.

The RADIUS server maintains a user database, which contains per-user authentication information. RADIUS servers provide a centralized authentication method for:

- Telnet Access
- Web Access
- Console to Switch Access
- Access Control Port (802.1x)

To display the RADIUS Global Configuration page, click **System** → **Management Security** → **RADIUS Global Configuration** in the tree view.

Figure 6-53. RADIUS Global Configuration

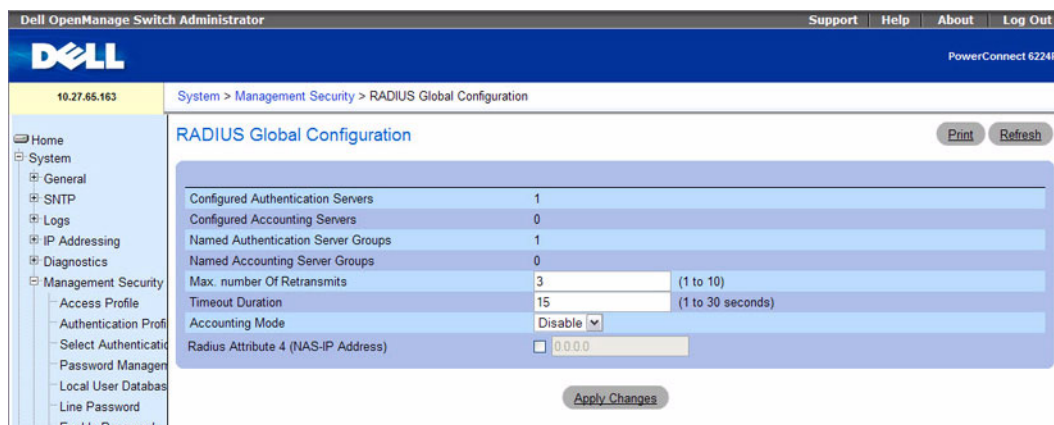

The RADIUS Global Configuration page contains the following fields:

- **Configured Authentication Servers** — The number of RADIUS authentication servers configured on the system. The value can range from 0 to 32.
- **Configured Accounting Servers** — The number of RADIUS accounting servers configured on the system. The value can range from 0 to 32.
- **Named Authentication Server Groups** — The number of authentication server groups configured on the system. An authentication server group contains one or more configured authentication servers that share the same RADIUS server name.
- **Named Accounting Server Groups** — The number of accounting server groups configured on the system. An accounting server group contains one or more configured authentication servers that share the same RADIUS server name.
- **Max Number of Retransmits** — The value of the maximum number of times a request packet is retransmitted. The valid range is 1-10. Consideration to maximum delay time should be given when configuring RADIUS max retransmit and RADIUS timeout. If multiple RADIUS servers are configured, the max retransmit value on each will be exhausted before the next server is attempted. A retransmit will not occur until the configured timeout value on that server has passed without a response from the RADIUS server. Therefore, the maximum delay in receiving a response from the RADIUS application equals the sum of (retransmit times timeout) for all configured servers. If the RADIUS request was generated by a user login attempt, all user interfaces will be blocked until the RADIUS application returns a response.
- **Timeout Duration** — The timeout value, in seconds, for request retransmissions. The valid range is 1 - 30. See the Max Number of Retransmits field description for more information about configuring the timeout duration.
- **Accounting Mode** — Use the menu to select whether the RADIUS accounting mode is enabled or disabled on the current server.
- **RADIUS Attribute 4 (NAS-IP Address)** — To set the network access server (NAS) IP address for the RADIUS server, select the option and enter the IP address of the NAS in the available field. The address should be unique to the NAS within the scope of the RADIUS server. The NAS IP address is only used in Access-Request packets.

Configuring Global RADIUS Settings Using CLI Commands

For information about the CLI commands that perform this function, see the RADIUS Commands chapter in the *CLI Reference Guide*. The following table summarizes the equivalent CLI commands you use.

Table 6-30. RADIUS Global Commands

CLI Command	Description
radius-server attribute	Sets the network access server (NAS) IP address for the RADIUS server.
radius-server retransmit	Specifies the number of times the software searches the list of RADIUS server hosts.
radius-server timeout	Sets the interval for which a switch waits for a server host to reply.
show radius-servers	Displays the RADIUS server settings.

RADIUS Server Configuration

From the **RADIUS Server Configuration** page, you can add a new RADIUS server, configure settings for a new or existing RADIUS server, and view RADIUS server status information. The RADIUS client on the switch supports up to 32 named authentication and accounting servers.

To access the RADIUS Server Configuration page, click **System** → **Management Security** → **RADIUS Server Configuration** in the tree view.

Figure 6-54. RADIUS Server Configuration

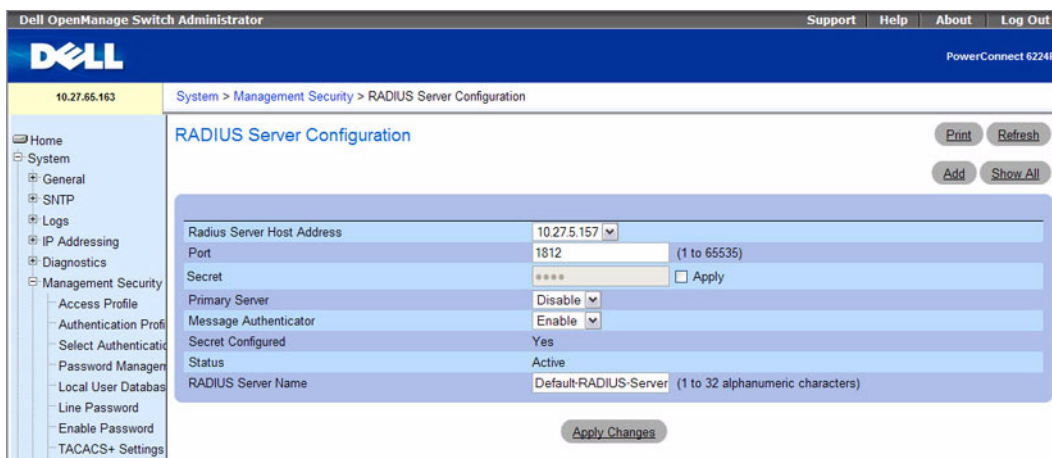

The **RADIUS Server Configuration** page contains the following fields:

- **RADIUS Server Host Address** — Use the drop-down menu to select the IP address of the RADIUS server to view or configure. Click **Add** to display the Add RADIUS Server page used to configure additional RADIUS servers.

- **Port** — Identifies the authentication port the server uses to verify the RADIUS server authentication. The port is a UDP port, and the valid range is 1-65535. The default port for RADIUS authentication is 1812.
- **Secret** — Shared secret text string used for authenticating and encrypting all RADIUS communications between the device and the RADIUS server. This secret must match the RADIUS encryption.
- **Apply** — The Secret will only be applied if this box is checked. If the box is not checked, anything entered in the Secret field will have no affect and will not be retained. This field is only displayed if the user has READWRITE access.
- **Primary Server** — Sets the selected server to the Primary (**Enable**) or Secondary (**Disable**) server. If you configure multiple RADIUS servers with the same RADIUS Server Name, designate one server as the primary and the other(s) as the backup server(s). The switch attempts to use the primary server first, and if the primary server does not respond, the switch attempts to use one of the backup servers with the same RADIUS Server Name.
- **Message Authenticator** — Enable or disable the message authenticator attribute for the selected server.
- **Secret Configured** — Indicates whether the shared secret for this server has been configured.
- **Status** — Indicates whether the selected RADIUS server is currently serving as the active RADIUS server. If more than one RADIUS server is configured with the same name, the switch selects one of the servers to be the active server from the group of servers with the same name. The status can be one of the following:
 - **Active** — When the switch sends a RADIUS request to the named server, the request is directed to the server selected as the active server. Initially the primary server is selected as the active server. If the primary server fails, one of the other servers becomes the active server. If the primary server is not configured, the active server is the most recently configured RADIUS server.
 - **Inactive** — The server is a backup RADIUS server.
 - **RADIUS Server Name** — Shows the RADIUS server name.

To change the name, enter up to 32 alphanumeric characters. Spaces, hyphens, and underscores are also permitted. If you do not assign a name, the server is assigned the default name Default-RADIUS-Server.

You can use the same name for multiple RADIUS Authentication servers. RADIUS clients can use RADIUS servers with the same name as backups for each other.

Adding a RADIUS Server

1. Open the **RADIUS Server Configuration** page.
2. Click **Add**.

The **Add RADIUS Server** page displays.

Figure 6-55. Add RADIUS Server

Add RADIUS Server Print Refresh

RADIUS Server Host Address

Radius Server Name (1 to 31 alphanumeric Characters)

Apply Changes Back

3. Enter an IP address and name for the RADIUS server to add.
4. Click **Apply Changes**.
The new RADIUS server is added, and the device is updated.

Viewing RADIUS Server Status and Removing a Named Server

1. Open the **RADIUS Server Configuration** page.
2. Click **Show All**.
The **RADIUS Named Server Status** page displays.

Figure 6-56. RADIUS Server Status

RADIUS Server Status Print Refresh

Status	RADIUS Server IP Address	Radius Server Name	Port Number	Server Type	Secret Configured	Message Authenticator	Remove
1 Active	192.168.23.3	Default-RADIUS-Server	1812	Secondary	FALSE	Enable	<input type="checkbox"/>
2 Active	192.168.23.66	Default-RADIUS-Server	1812	Secondary	FALSE	Enable	<input type="checkbox"/>

Apply Changes Back

3. To remove a named server, select the check box in the **Remove** column.
4. Click **Apply Changes**.
The RADIUS server is removed from the list.

Configuring RADIUS Server Settings Using CLI Commands

For information about the CLI commands that perform this function, see the **RADIUS Commands** chapter in the *CLI Reference Guide*. The following table summarizes the equivalent CLI commands you use.

Table 6-31. RADIUS Server Commands

CLI Command	Description
auth-port	Sets the port number for authentication requests of the designated radius server.
key	Sets the authentication and encryption key for all RADIUS communications between the switch and the RADIUS daemon.
msgauth	Enables the message authenticator attribute to be used for the RADIUS Authenticating server being configured.
name	Assigns a name to a RADIUS server.
primary	Specifies that a configured server should be the primary server in the group of authentication servers which have the same server name.
radius-server host	Specifies a RADIUS server host and enter RADIUS Configuration mode.
show radius-servers	Displays the RADIUS server settings.

RADIUS Accounting Server Configuration

From the **RADIUS Accounting Server Configuration** page, you can add a new RADIUS accounting server, configure settings for a new or existing RADIUS accounting server, and view RADIUS accounting server status information. The RADIUS client on the switch supports up to 32 named authentication and accounting servers.

To access the RADIUS Server Configuration page, click **System** → **Management Security** → **RADIUS Accounting Server Configuration** in the tree view.

Figure 6-57. RADIUS Accounting Server Configuration

The screenshot shows the Dell OpenManage Switch Administrator interface. The top navigation bar includes 'Support', 'Help', 'About', and 'Log Out'. The breadcrumb trail is 'System > Management Security > RADIUS Accounting Server Configuration'. The main configuration area contains the following fields and controls:

- RADIUS Accounting Server Host Address:** A dropdown menu.
- Port:** A text input field with a range constraint '(1 to 65535)'.
- Secret:** A text input field with an 'Apply' checkbox.
- Secret configured:** A checkbox.
- RADIUS Accounting Server Name:** A text input field with a range constraint '(1 to 32 alphanumeric characters)'.

Buttons for 'Print', 'Refresh', 'Add', 'Show All', and 'Apply Changes' are visible.

The RADIUS Accounting Server Configuration page contains the following fields:

- **RADIUS Accounting Server Host Address** — Use the drop-down menu to select the IP address of the accounting server to view or configure. Click **Add** to display the **Add RADIUS Accounting Server** page used to configure additional RADIUS servers.
- **Port** — Identifies the authentication port the server uses to verify the RADIUS accounting server authentication. The port is a UDP port, and the valid range is 1-65535. The default port for RADIUS accounting is 1813.
- **Secret** — Specifies the shared secret to use with the specified accounting server. This field is only displayed if you are logged into the switch with READWRITE access.
- **Apply** — The Secret will only be applied if this box is checked. If the box is not checked, anything entered in the Secret field will have no affect and will not be retained. This field is only displayed if you are logged into the switch with READWRITE access.
- **Secret Configured** — Indicates whether the shared secret for this server has been configured.
- **RADIUS Accounting Server Name** — Enter the name of the RADIUS accounting server. The name can contain from 1 to 32 alphanumeric characters. Hyphens, and underscores are also permitted. You can use the same name for multiple RADIUS accounting servers. RADIUS clients can use accounting servers with the same name as backups for each other.

Adding a RADIUS Accounting Server

1. Open the **RADIUS Accounting Server Configuration** page.
2. Click **Add**.

The **Add RADIUS Accounting Server** page displays.

Figure 6-58. Add RADIUS Accounting Server

3. Enter an IP address and name for the RADIUS accounting server to add.
4. Click **Apply Changes**.

The new RADIUS server is added, and the device is updated.

Viewing RADIUS Accounting Server Status and Removing a Accounting Named Server

1. Open the **RADIUS Accounting Server Configuration** page.
2. Click **Show All**.

The **RADIUS Named Accounting Server Status** page displays.

Figure 6-59. RADIUS Accounting Server Status

	RADIUS Accounting Server Name	IP Address	Port Number	Secret Configured	Remove
1	Default-RADIUS-Server	192.168.23.3	1813	False	<input type="checkbox"/>

3. To remove a named accounting server, select the check box in the **Remove** column.
4. Click **Apply Changes**.

The RADIUS accounting server is removed from the list.

Configuring RADIUS Accounting Server Settings Using CLI Commands

For information about the CLI commands that perform this function, see the RADIUS Commands chapter in the *CLI Reference Guide*. The following table summarizes the equivalent CLI commands you use.

Table 6-32. RADIUS Accounting Server Commands

CLI Command	Description
acct-port	Sets the port number for the designated radius accounting server.
key	Sets the authentication and encryption key for all RADIUS communications between the switch and the RADIUS daemon.
name	Assigns a name to a RADIUS accounting server.
radius-server acct	Specifies a RADIUS accounting server host and enter RADIUS Server Configuration mode.
show radius-servers	Displays the RADIUS accounting server settings.

RADIUS Accounting Server Statistics

Use the **RADIUS Accounting Server Statistics** page to view statistical information for each RADIUS accounting server configured on the system.

To access the **RADIUS Accounting Server Statistics** page, click **System** → **Management Security** → **RADIUS Accounting Server Statistics** in the tree view.

Figure 6-60. RADIUS Accounting Server Statistics

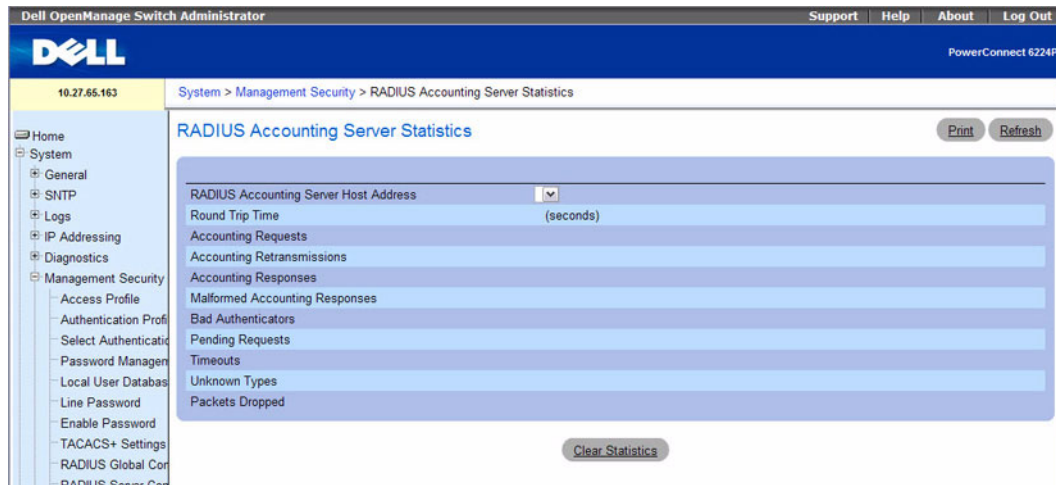

The RADIUS Accounting Server Statistics page contains the following fields:

- **RADIUS Accounting Server Host Address** — Use the drop-down menu to select the IP address of the RADIUS accounting server for which to display statistics.
- **Round Trip Time** — Displays the time interval, in hundredths of a second, between the most recent Accounting-Response and the Accounting-Request that matched it from this RADIUS accounting server.
- **Accounting Requests** — The number of RADIUS Accounting-Request packets sent to this server. This number does not include retransmissions.
- **Accounting Retransmissions** — The number of RADIUS Accounting-Request packets retransmitted to this server.
- **Accounting Responses** — Displays the number of RADIUS packets received on the accounting port from this server.
- **Malformed Accounting Responses** — Displays the number of malformed RADIUS Accounting-Response packets received from this server. Malformed packets include packets with an invalid length. Bad authenticators and unknown types are not included as malformed accounting responses.
- **Bad Authenticators** — Displays the number of RADIUS Accounting-Response packets that contained invalid authenticators received from this accounting server.
- **Pending Requests** — The number of RADIUS Accounting-Request packets destined for this server that have not yet timed out or received a response.
- **Timeouts** — The number of accounting timeouts to this server.
- **Unknown Types** — The number of RADIUS packets of unknown type which were received from this server on the accounting port.

- **Packets Dropped** — The number of RADIUS packets received from this server on the accounting port and dropped for some other reason.

Viewing RADIUS Accounting Server Statistics Using CLI Commands

For information about the CLI commands that perform this function, see the RADIUS Commands chapter in the *CLI Reference Guide*. The following table summarizes the equivalent CLI commands you use.

Table 6-33. RADIUS Accounting Server Statistics Command

CLI Command	Description
show radius-servers statistics accounting	Shows the statistics for an authentication server.

RADIUS Server Statistics

Use the **RADIUS Server Statistics** page to view statistical information for each RADIUS server configured on the system.

To access the RADIUS Server Statistics page, click **System** → **Management Security** → **RADIUS Server Statistics** in the tree view.

Figure 6-61. RADIUS Server Statistics

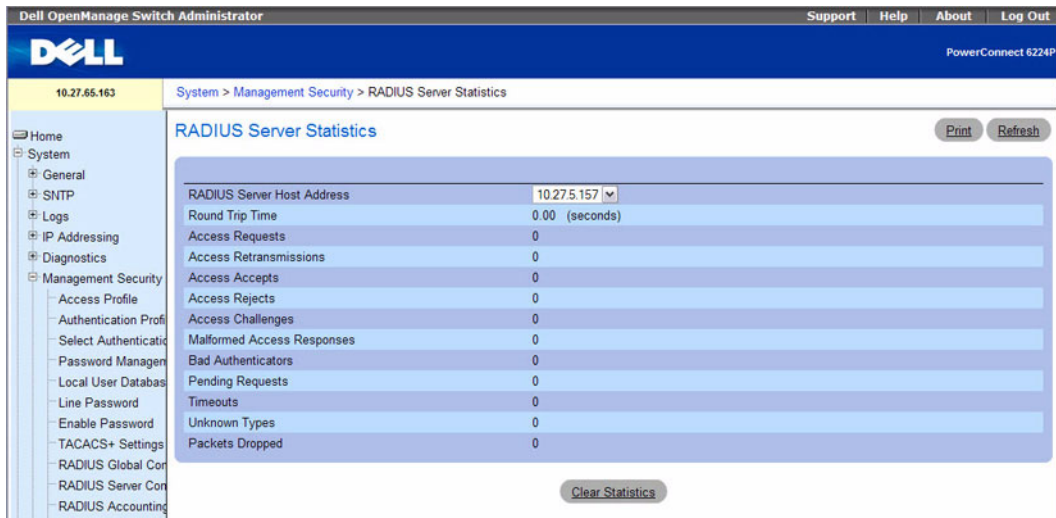

The **RADIUS Server Statistics** page contains the following fields:

- **RADIUS Server Host Address** — Use the drop-down menu to select the IP address of the RADIUS server for which to display statistics.

- **Round Trip Time** — The time interval, in hundredths of a second, between the most recent Access-Reply/Access-Challenge and the Access-Request that matched it from this RADIUS authentication server.
- **Access Requests** — The number of RADIUS Access-Request packets sent to this server. This number does not include retransmissions.
- **Access Retransmissions** — The number of RADIUS Access-Request packets retransmitted to this server.
- **Access Accepts** — The number of RADIUS Access-Accept packets, including both valid and invalid packets, that were received from this server.
- **Access Rejects** — The number of RADIUS Access-Reject packets, including both valid and invalid packets, that were received from this server.
- **Access Challenges** — The number of RADIUS Access-Challenge packets, including both valid and invalid packets, that were received from this server.
- **Malformed Access Responses** — The number of malformed RADIUS Access-Response packets received from this server. Malformed packets include packets with an invalid length. Bad authenticators or signature attributes or unknown types are not included as malformed access-responses.
- **Bad Authenticators** — The number of RADIUS Access-Response packets containing invalid authenticators or signature attributes received from this server.
- **Pending Requests** — The number of RADIUS Access-Request packets destined for this server that have not yet timed out or received a response.
- **Timeouts** — The number of authentication timeouts to this server.
- **Unknown Types** — The number of RADIUS packets of unknown type which were received from this server on the authentication port.
- **Packets Dropped** — The number of RADIUS packets received from this server on the authentication port and dropped for some other reason.

Viewing RADIUS Server Statistics Using CLI Commands

For information about the CLI commands that perform this function, see the RADIUS Commands chapter in the *CLI Reference Guide*. The following table summarizes the equivalent CLI commands you use.

Table 6-34. RADIUS Server Statistics Command

CLI Command	Description
show radius-servers statistics authentication	Shows the statistics for an authentication server.

Authorization Network RADIUS

In some networks, the RADIUS server is responsible for assigning traffic to a particular VLAN. From the **Authorization Network RADIUS** page, you can enable the switch to accept VLAN assignment by the RADIUS server.

To display the **Authorization Network RADIUS** page, click **System Management** → **Security** → **Authorization Network RADIUS** in the tree view.

Figure 6-62. Authorization Network RADIUS

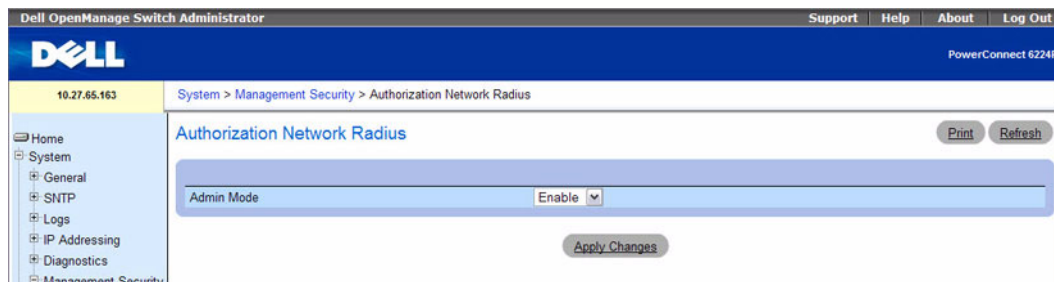

The **Authorization Network RADIUS** page contains the following field:

- **Admin Mode**— Enables or disables the ability of the switch to accept VLAN assignment from the RADIUS server.

Enabling VLAN Assignments by the RADIUS Server Using CLI Commands

For information about the CLI commands that perform this function, see the **RADIUS Commands** chapter in the *CLI Reference Guide*. The following table summarizes the equivalent CLI commands you use.

Table 6-35. RADIUS Network Authorization Command

CLI Command	Description
aaa authorization network default radius	Enables the switch to accept VLAN assignment by the RADIUS server.

Telnet Server

Use the **Telnet Server** page to enable or disable telnet service on the switch or to modify the telnet port. To display the **Telnet Server** page, click **System** → **Management Security** → **Telnet Server**.

Figure 6-63. Telnet Server

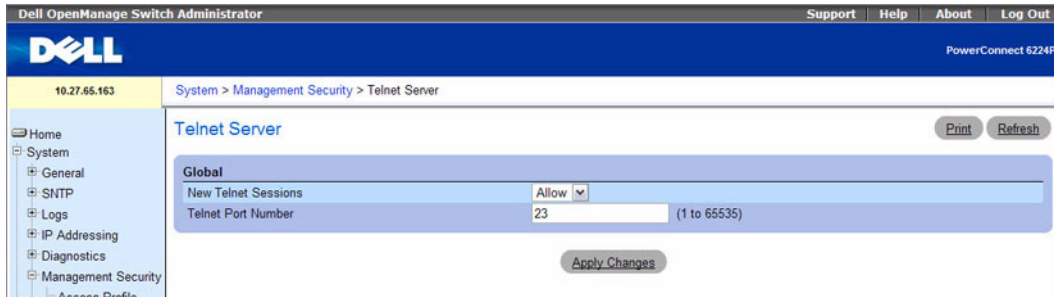

The Telnet Server page contains the following fields:

- **New Telnet Sessions** — Controls the administrative mode for inbound telnet sessions. If you set the mode to Block, new telnet sessions are not allowed, but existing sessions are not interrupted. The default value is Allow.
- **Telnet Port Number** — Port number on which telnet session can be initiated. This port will be used for new inbound Telnet session on the switch. After you modify the telnet server port, new inbound telnet sessions use the new port and existing telnet sessions are not affected.

Modifying Telnet Server Settings

1. Open the Telnet Server Configuration page.
2. Configure the relevant fields.
3. Click **Apply Changes**.

The settings are saved, and the device is updated.

Configuring the Telnet Server Using CLI Commands

For information about the CLI commands that perform this function, see the Telnet Server Commands chapter in the *CLI Reference Guide*. The following table summarizes the equivalent CLI commands you use.

Table 6-36. Telnet Server Commands

CLI Command	Description
ip telnet server disable	Enables/disables the Telnet service on the switch.
ip telnet port	Configures the Telnet service port number on the switch.
show ip telnet	Displays the status of the Telnet server and the Telnet service port number.

Denial of Service

Denial of Service refers to the exploitation of a variety of vulnerabilities which would interrupt the service of a host or make a network unstable. Use the **Denial of Service** page to configure settings to help prevent denial of service attacks.

To display the **Denial of Service** page, click **System** → **Management Security** → **Denial of Service** in the tree view.

Figure 6-64. Denial of Service



The **Denial of Service** page contains the following fields:

- **Denial of Service SIP=DIP** — Enabling SIP=DIP DoS prevention causes the switch to drop packets that have a source IP address equal to the destination IP address.
- **Denial of Service First Fragment** — Enabling First Fragment DoS prevention causes the switch to drop packets that have a TCP header smaller than the configured minimum TCP header size (Min TCP Hdr Size).
- **Denial of Service Min TCP Hdr Size** — Specify the minimum TCP header size allowed. If First Fragment DoS prevention is enabled, the switch will drop packets that have a TCP header smaller than this configured value.
- **Denial of Service TCP Fragment** — Enabling TCP Fragment DoS prevention causes the switch to drop packets that have an IP fragment offset equal to one.
- **Denial of Service TCP Flag** — Enabling TCP Flag DoS prevention causes the switch to drop packets that meet any of the following conditions:
 - TCP flag SYN set and TCP source port less than 1024
 - TCP control flags set to 0 and TCP sequence number set to 0
 - TCP flags FIN, URG, and PSH set and TCP sequence number set to 0

- Both TCP flags SYN and FIN set
- **Denial of Service L4 Port** — Enabling L4 Port DoS prevention causes the switch to drop packets that have the TCP/UDP source port equal to TCP/UDP destination port.
- **Denial of Service ICMP** — Enabling ICMP DoS prevention causes the switch to drop ICMP packets that have a type set to ECHO_REQ (ping) and a size greater than the configured ICMP packet size (ICMP Pkt Size).
- **Denial of Service Max ICMP Pkt Size** — Specify the maximum ICMP packet size to allow. If ICMP DoS prevention is enabled, the switch will drop ICMP ping packets that have a size greater than this configured value.

Configuring Denial of Service Settings

1. Open the **Denial of Service** page.
2. Specify the desired settings.
3. Click **Apply Changes**.

The device is updated with the new settings.

Configuring Denial of Service Settings Using CLI Commands

For information about the CLI commands that perform this function, see the Denial of Service Commands chapter in the *CLI Reference Guide*. The following table summarizes the equivalent CLI commands you use to configure Denial of Service.

Table 6-37. Denial of Service Configuration Commands

CLI Command	Description
dos-control firstfrag	Enables Minimum TCP Header Size Denial of Service protection.
dos-control icmp	Enables Maximum ICMP Packet Size Denial of Service protections.
dos-control l4port	Enables L4 Port Denial of Service protection.

Table 6-37. Denial of Service Configuration Commands

CLI Command	Description
dos-control sipdip	Enables Source IP Address = Destination IP Address (SIP=DIP) Denial of Service protection.
dos-control tcpflag	Enables TCP Flag Denial of Service protections.
dos-control tcpfrag	Enables TCP Fragment Denial of Service protection.
ip icmp echo-reply	Enables or disables the generation of ICMP Echo Reply messages.
ip icmp error-interval	Limits the rate at which IPv4 ICMP error messages are sent.
ip icmp unreachable	Enables the generation of ICMP Destination Unreachable messages.
ip icmp redirects	Enables the generation of ICMP Redirect messages.
ipv6 icmp error-interval	Limits the rate at which ICMPv6 error messages are sent.
ipv6 unreachable	Enables the generation of ICMPv6 Destination Unreachable messages.
show dos-control	Displays Denial of Service configuration information.

Captive Portal

The Captive Portal (CP) feature allows you to block clients directly connected to the switch from accessing the network until user verification has been established. You can configure CP verification to allow access for both guest and authenticated users. Authenticated users must be validated against a database of authorized Captive Portal users before access is granted. The database can be stored locally on the switch or on a RADIUS server.

When a port is enabled for Captive Portal, all the traffic coming onto the port from the unauthenticated clients are dropped except for the ARP, DHCP, DNS and NETBIOS packets. These packets are allowed to be forwarded by the switch so that the unauthenticated clients can get an IP address and be able to resolve the hostname or domain names. Data traffic from authenticated clients goes through as expected. If an unauthenticated client opens a web browser and tries to connect to network, the Captive Portal redirects all the HTTP/HTTPS traffic from unauthenticated clients to the authenticating server on the switch. A Captive portal web page is sent back to the unauthenticated client and the client can authenticate and based upon the authentication the client is given access to the port.



NOTE: For information about the CLI commands you use to view and configure Captive Portal settings, refer to the Captive Portal Commands chapter in the CLI Reference Guide.

The Captive Portal folder contains links to the following pages that help you view and configure system Captive Portal settings:

- CP Global Configuration
- CP Configuration
- CP Web Customization
- Local User

- User Group
- Interface Association
- CP Status
- CP Activation and Activity Status
- Interface Activation Status
- Interface Capability Status
- Client Summary
- Client Detail
- CP Interface Client Status
- CP Client Status

CP Global Configuration

From the **CP Global Configuration** page, you can control the administrative state of the CP feature and configure global settings that affect all captive portals configured on the switch.

To configure the global CP settings, click **System** → **Captive Portal** → **Global Configuration**.

Figure 6-65. CP Global Configuration

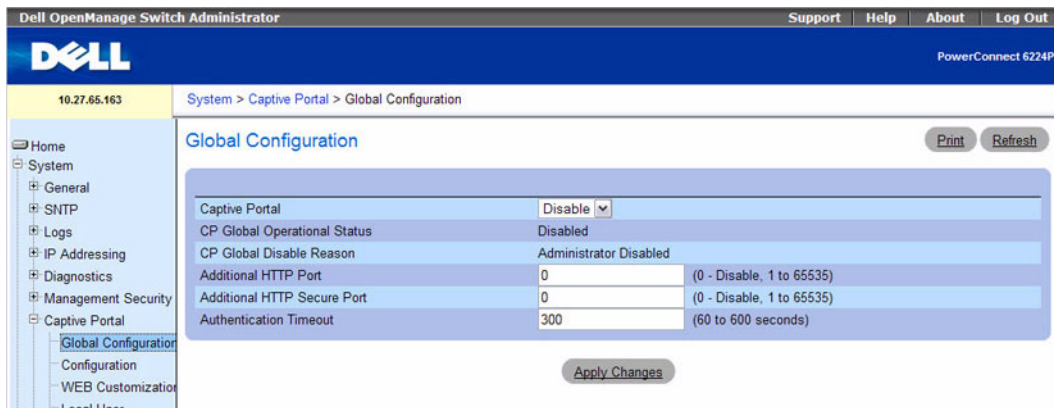

The **CP Global Configuration** page contains the following fields:

- **Captive Portal** — Enable or disable the CP feature on the switch.
- **CP Global Operational Status** — Shows whether the CP feature is enabled.
- **CP Global Disable Reason** — If CP is disabled, this field displays the reason, which can be one of the following:
 - None
 - Administrator Disabled

- No IPv4 Address
- Routing Enabled, but no IPv4 routing interface
- **Additional HTTP Port** — HTTP traffic uses port 80, but you can configure an additional port for HTTP traffic. Enter a port number between 0-65535 (excluding ports 80, 443, and the configured switch management port).
- **Additional HTTP Secure Port** — HTTP traffic over SSL (HTTPS) uses port 443, but you can configure an additional port for HTTPS traffic. Enter a port number between 0-65535 (excluding ports 80, 443, and the configured switch management port).
- **Authentication Timeout** — To access the network through a portal, the client must first enter authentication information on an authentication Web page. Enter the number of seconds to keep the authentication session open with the client. When the timeout expires, the switch disconnects any active TCP or SSL connection with the client.

CP Configuration

From the **CP Configuration** page, you can view summary information about captive portals on the system, add a captive portal, and configure existing captive portals.

The switch supports 10 CP configurations. CP configuration 1 is created by default and can not be deleted. Each captive portal configuration can have unique guest or group access modes and a customized acceptance use policy that displays when the client connects.

To view summary information about existing captive portals, or to add or delete a captive portal, click **System →Captive Portal →Configuration**.

Figure 6-66. CP Configuration

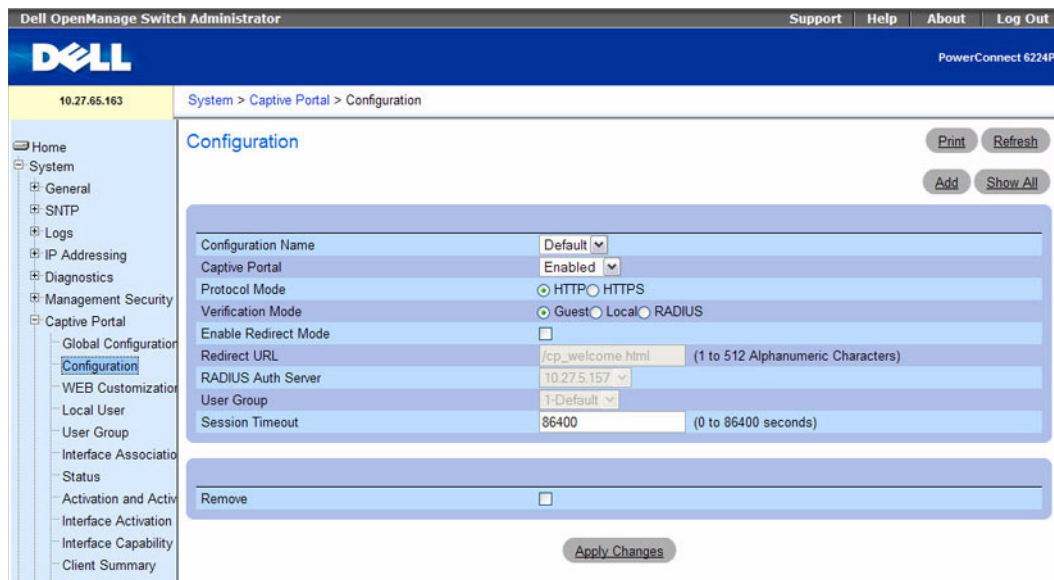

The CP Configuration page contains the following fields:

- **Configuration Name** — If multiple CP configurations exist on the system, select the CP configuration to view or configure. Use the **Add** button to add a new CP configuration to the switch.
- **Captive Portal** — Use this field to enable or disable the selected CP configuration.
- **Protocol Mode** — Choose whether to use HTTP or HTTPS as the protocol for the portal to use during the verification process.
 - **HTTP** — Does not use encryption during verification
 - **HTTPS** — Uses the Secure Sockets Layer (SSL), which requires a certificate to provide encryption. The certificate is presented to the user at connection time.
- **Verification Mode** — Select the mode for the CP to use to verify clients:
 - **Guest** — The user does not need to be authenticated by a database.
 - **Local** — The switch uses a local database to authenticated users.
 - **RADIUS** — The switch uses a database on a remote RADIUS server to authenticate users.



NOTE: To configure authorized users on the local or remote RADIUS database, see "Local User" on page 203.

- **Enable Redirect Mode** — Select this option to specify that the CP should redirect the newly authenticated client to the configured URL. If this option is clear, the user sees the welcome page after a successful verification.
- **Redirect URL** — Specify the URL to which the newly authenticated client is redirected if the URL Redirect Mode is enabled.

- **RADIUS Auth Server** — If the verification mode is RADIUS, click the drop-down menu and select the name of the RADIUS server used for client authentications. The switch acts as the RADIUS client and performs all RADIUS transactions on behalf of the clients. To configure RADIUS server information, go to the **Management Security** → **RADIUS Server Configuration** page.
- **User Group** — If the Verification Mode is Local or RADIUS, assign an existing User Group to the captive portal or create a new group. All users who belong to the group are permitted to access the network through this portal. The User Group list is the same for all CP configurations on the switch.
- **Session Timeout** — Enter the number of seconds to wait before terminating a session. A user is logged out once the session timeout is reached. If the value is set to 0 then the timeout is not enforced. The default value is 0. The range is 0 to 86400 seconds.

Removing a Captive Portal Configuration

1. To remove a CP configuration, select the CP configuration to remove from the Configuration Name menu.
2. Select the **Remove** option at the bottom of the page.
3. Click **Apply Changes**.

Adding a Captive Portal Configuration

1. Open the **Captive Portal Configuration** page.
2. Click **Add**.

The Add CP Configuration page displays:

Figure 6-67. Add CP Configuration

3. Enter a name for the new CP configuration.
4. Click **Apply Changes**.
The CP configuration is added, and the device is updated.

Displaying the CP Configuration Summary

1. Open the **Captive Portal Configuration** page.
2. Click **Show All**.

The **CP Summary** page displays:

Figure 6-68. CP Summary

Summary Print Refresh

Configuration	Mode	Protocol	Verification	Remove
Default	Enabled	HTTP	Guest	<input type="checkbox"/>

Apply Changes Back

3. To remove a CP configuration, select the **Remove** option in the CP configuration row and click **Apply Changes**.

CP Web Customization

When a client connects to the access point, the user sees a Web page. The **CP Web Customization** page allows you to customize the appearance of that page with specific text and images. To display the **CP Web Customization** page, click **System** → **Captive Portal** → **Web Customization**.

To configure the portal users in a remote RADIUS server, see "Configuring Users in a Remote RADIUS Server" on page 205.

Figure 6-69. CP Web Customization

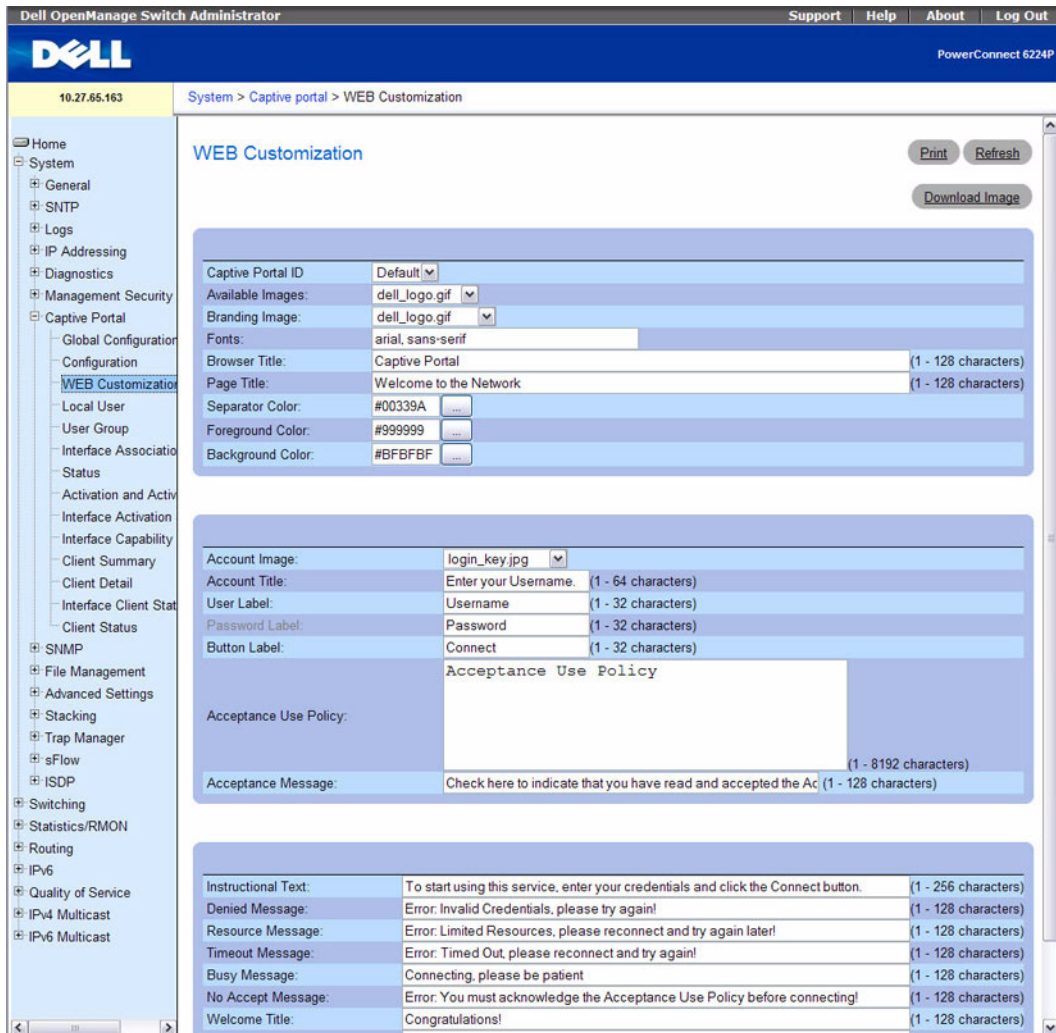

The CP Web Customization page contains the following fields:

- **Captive Portal ID** — The drop-down menu lists each CP configured on the switch. To view information about the clients connected to the CP, select it from the list.
- **Branding Image** — Select the name of the image file to display on the top left corner of the page. This image is used for branding purposes, such as the company logo.
- **Fonts** — Enter the name of the font to use for all text on the CP page.
- **Browser Title** — Enter the text to display on the client’s Web browser title bar or tab.

- **Page Title** — Enter the text to use as the page title. This is the text that identifies the page.
- **Separator Color** — Enter the hexadecimal color code to use as the separator above and below the login area and acceptance use policy. Press the ... button for a color pick list. The sample account information is updated with the colors you choose.
- **Foreground Color**— Enter the hexadecimal color code to use as the foreground color in the login area. Press the ... button for a color pick list. The sample account information is updated with the colors you choose.
- **Background Color** — Enter the hexadecimal color code to as the background color in the login area. Press the ... button for a color pick list. The sample account information is updated with the colors you choose.
- **Account Image** — Select the image that will display on the Captive Portal page above the login field. The image display area is 55H X 310W pixels. Your image will be resized to fit the display area. Click **Download Image**, then browse to and select an image on your local system (or accessible from your local system) to download to the switch.
- **Account Title** — Enter the summary text to display that instructs users to authenticate.
- **User Label** — Enter the text to display next to the field where the user enters the username.
- **Password Label** — Enter the text to display next to the field where the user enters the password.
- **Button Label** — Enter the text to display on the button the user clicks to connect to the network.
- **Acceptance Use Policy** — Enter the text to display in the Acceptance Use Policy field. The acceptance use policy instructs users about the conditions under which they are allowed to access the network. The policy can contain up to 128 characters.
- **Acceptance Message** — Enter the text to display next to the box that the user must select to indicate that he or she accepts the terms of use.
- **Instructional Text** — Enter the detailed text to display that instructs users to authenticate. This text appears under the button.
- **Denied Message** — Enter the text to display when the user does not provide valid authentication information. This message displays after the user clicks the button to connect to the network.
- **Resource Message** — Enter the text to display when the system has rejected authentication due to system resource limitations. This message displays after the user clicks the button to connect to the network.
- **Timeout Message** — Enter the text to display when the system has rejected authentication because the authentication transaction took too long. This could be due to user input time, or a timeout due to the overall transaction.
- **Busy Message** — Enter the text to display when the user does not provide valid authentication information. This message displays after the user clicks the button to connect to the network.
- **No Accept Message** — Enter the text to display when the user did not accept the acceptance use policy. This message displays after the user clicks the button to connect to the network.

- **Welcome Title** — Enter the title to display to greet the user after he or she successfully connects to the network.
- **Welcome Text** — Enter the optional text to display to further identify the network to be access by the CP user. This message displays under the Welcome Title.

Previewing and Resetting the CP Web Page

To preview the custom CP Web page, click **Preview**.

To reset the CP Web page to the default settings, click **Clear**.

Local User

You can configure a portal to accommodate guest users and authorized users. Guest users do not have assigned user names and passwords. Authorized users provide a valid user name and password that must first be validated against a local database or RADIUS server. Authorized users can gain network access once the switch confirms the user’s credentials.

The **Local User** page allows you to add authorized users to the local database, which can contain up to 1024 user entries. You can also add and delete users from the local database from the Local User page.

To view and configure CP users in the local database, click **System** → **Captive Portal** → **Local User**.

The following figure shows the **Local User** page after a user has been added. If no users have been added to the switch, many of the fields do not display on the screen.

Figure 6-70. Local User Configuration

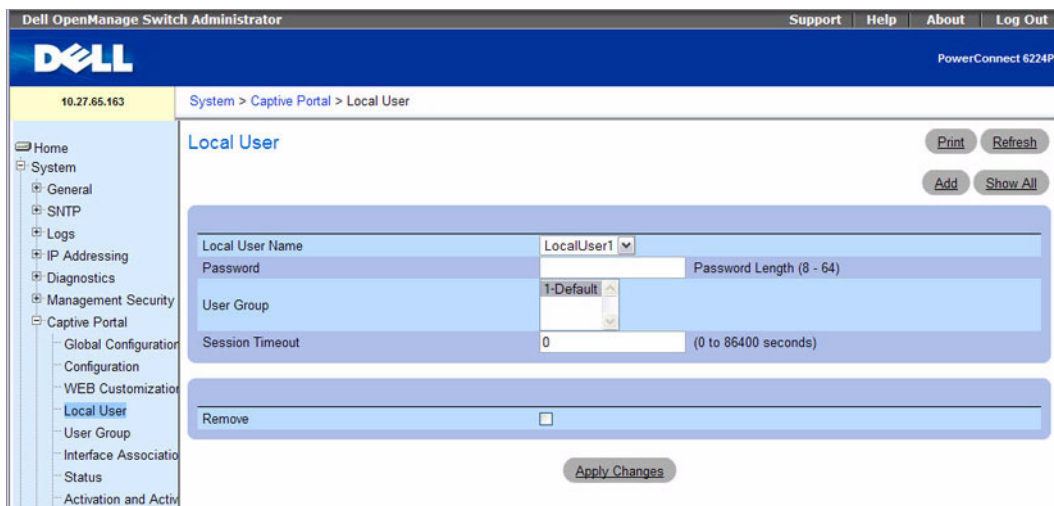

The **Local User** page contains the following fields:

- **Local User Name** — Enter the name of the user.

- **Password** — Enter a password for the user. The password length can be from 8 to 64 characters.
- **User Group** — Assign the user to at least one User Group. New users are assigned to the 1-Default user group by default.
- **Session Timeout** — Enter the number of seconds a user is permitted to remain connected to the network. Once the Session Timeout value is reached, the user is logged out automatically. A value of 0 means that the user does not have a Session Timeout limit.

Removing a Local User

1. Select the user from the **Local User Name** field.
2. Select the **Remove** option at the bottom of the page.
3. Click **Apply Changes** to remove the user.

Adding a Local User

1. Open the **Local User** page.
2. Click **Add**.

The **Add Local User** page displays:

Figure 6-71. Add Local User

3. Enter a name for the new user. The name is 1 to 31 alphanumeric characters.
4. Enter a password for the new user. The password is 8-64 characters in length.
5. Click **Apply Changes**.

The local user is added, and the device is updated.

If no user is added, a **No User Exists** message is shown in the web page instead of the empty controls.

Displaying the Local User Summary Page

1. Open the **Local User** page.
2. Click **Show All**.

The **CP Local User Summary** page displays:

Figure 6-72. CP Local User Summary

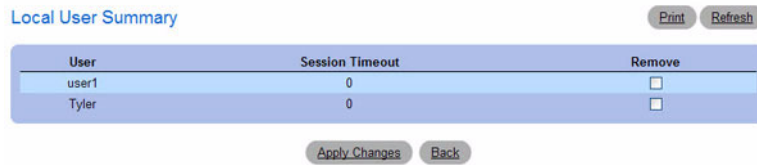

- To remove a configured user, select the **Remove** option in the appropriate row, and then click **Apply Changes**.

Configuring Users in a Remote RADIUS Server

You can use a remote RADIUS server client authorization. You must add all users to the RADIUS server. The local database does not share any information with the remote RADIUS database.

The following table indicates the RADIUS attributes you use to configure authorized captive portal clients. The table indicates both RADIUS attributes and vendor-specific attributes (VSA). VSAs are denoted in the Attribute column and are comma delimited (vendor id, attribute id).

Table 6-38. Captive Portal User RADIUS Attributes

Attribute	Number	Description	Range	Usage	Default
User-Name	1	User name to be authorized	1-32 characters	Required	None
User-Password	2	User password	8-64 characters	Required	None
Session-Timeout	27	Logout once session timeout is reached (seconds). If the attribute is 0 or not present then use the value configured for the captive portal.	Integer (seconds)	Optional	0
Idle-Timeout	28	Logout once idle timeout is reached (seconds). If the attribute is 0 or not present then use the value configured for the captive portal.	Integer (seconds)	Optional	0

User Group

You can assign Local Users to User Groups that you create. If the Verification Mode is Local or RADIUS, you assign a User Group to a CP Configuration. All users who belong to the group are permitted to access the network through this portal. The User Group list is the same for all CP configurations on the switch.

To view and configure User Groups, click **System** → **Captive Portal** → **User Group**.

Figure 6-73. User Group

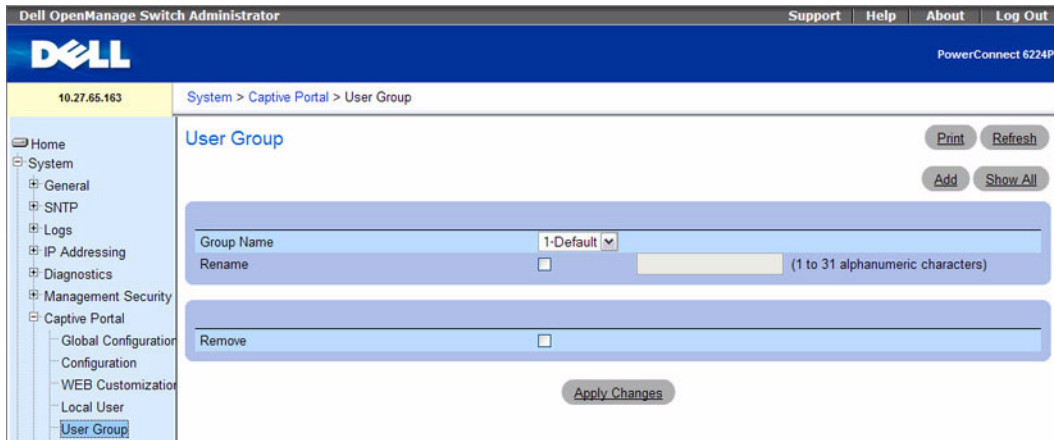

The **User Group** page contains the following fields:

- **Group Name** — The menu contains the name of all of the groups configured on the system. The Default user group is configured by default. New users are assigned to the 1-Default user group by default. To delete a user group, select the name of the group from the Group Name menu, select the **Remove** option, and then click **Apply Changes**.
- **Rename** — To rename a Group Name, click the check box, type a new group name from 1 to 31 alphanumeric characters in the **Rename** field, then click **Apply Changes**.

Adding a User Group

1. Open the **User Group** page.
2. Click **Add**.

The **Add Local User** page displays:

Figure 6-74. Add User Group



3. Enter a name for the new group.
4. Click **Apply Changes**.
The group is added, and the device is updated.

Displaying the User Group Page

1. Open the User Group page.
2. Click Show All.

The User Group Summary page displays:

Figure 6-75. CP User Group Summary

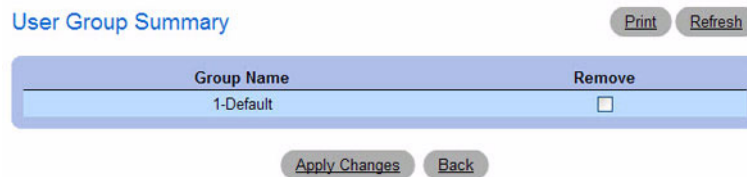

3. To remove a configured group, select the **Remove** option in the appropriate row, and then click **Apply Changes**.

Interface Association

From the **Interface Association** page, you can associate a configured captive portal with specific interfaces. The captive portal feature only runs on the interfaces that you specify. A captive portal can have multiple interfaces associated with it, but an interface can be associated to only one CP at a time. To view the **Interface Association** page, click **System** → **Captive Portal** → **Interface Association**.

Figure 6-76. CP Interface Association

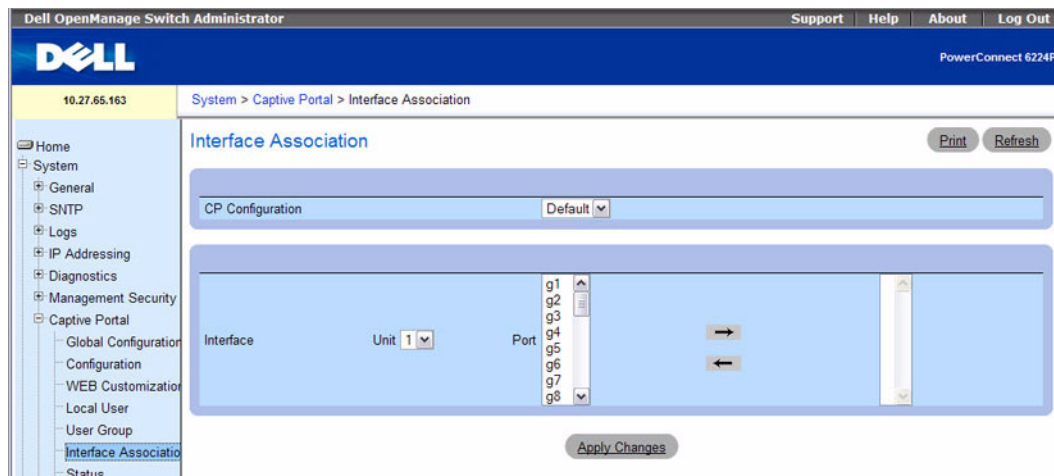

The **Interface Association** page contains the following fields:

- **CP Configuration** — Lists the captive portals configured on the switch by number and name.
- **Interface List** — Lists the interfaces available on the switch that are not currently associated with a captive portal.

Use the following steps to associate one or more interfaces with a captive portal:

1. Select the desired captive portal from the **CP Configuration** list.
2. Select the interface or interfaces from the Interface list. To select more than one interface, hold **CTRL** and click multiple interfaces.
3. Click **Apply Changes**.



NOTE: When you associate an interface with a captive portal, the interface is removed from the Interface List. Each interface can be associated with only one captive portal at a time.

Use the following steps to remove an interface from the Associated Interfaces list for a captive portal:

1. Select the desired captive portal from the **CP Configuration** list.
2. In the Associated Interfaces field, select the interface or interfaces to remove. To select more than one interface, hold **CTRL** and click multiple interfaces.
3. Click **Delete**.
4. The interface is removed from the Associated Interface list and appears in the Interface List.

CP Status

The **CP Status** page contains a variety of information about the CP feature. From the **CP Status** page, you can access information about the CP activity and interfaces.

To view captive portal status information, click **System** → **Captive Portal** → **Status**.

Figure 6-77. CP Status

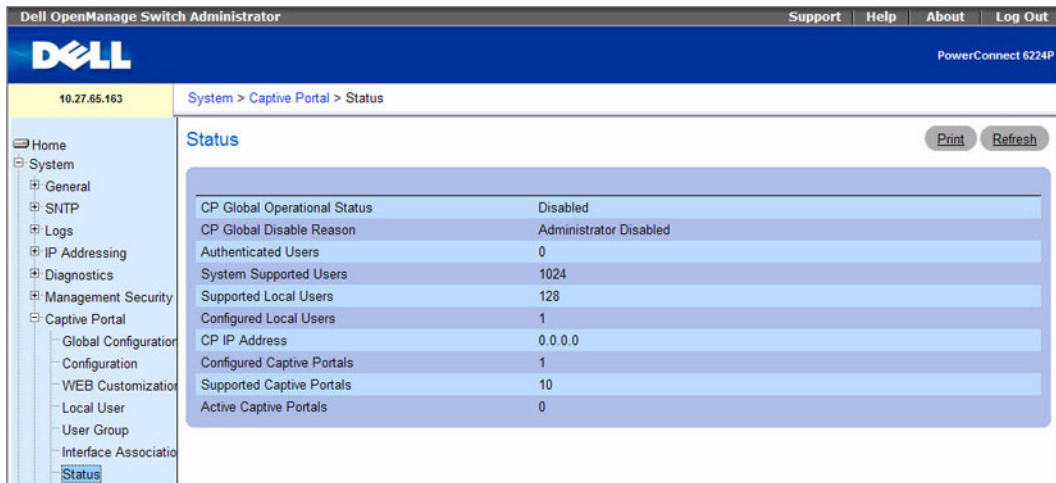

The CP Status page contains the following fields:

- **CP Global Operational Status** — Shows whether the CP feature is enabled.
- **CP Global Disable Reason** — Indicates the reason for the CP to be disabled, which can be one of the following:
 - None
 - Administratively Disabled
 - No IPv4 Address
 - Routing Enabled, but no IPv4 routing interface
- **Authenticated Users** — Shows the number of users currently authenticated to all captive portal instances on this switch.
- **System Supported Users** — Shows the number of authenticated users that the system can support.
- **Supported Local Users** — Shows the number of entries that the Local User database supports.
- **Configured Local Users** — Shows the number of entries configured as local Users.
- **CP IP Address** — Shows the captive portal IP address
- **Configured Captive Portals** — Shows the number of captive portals configured on the switch.
- **Supported Captive Portals** — Shows the number of supported captive portals in the system.
- **Active Captive Portals** — Shows the number of captive portal instances that are operationally enabled.

CP Activation and Activity Status

The CP Activation and Activity Status page provides information about each CP configured on the switch.

The CP Activation and Activity Status page has a drop-down menu that contains all captive portals configured on the switch. When you select a captive portal, the activation and activity status for that portal displays.

To view activation and activity information, click **System** → **Captive Portal** → **Activation and Activity Status**.

Figure 6-78. CP Activation and Activity Status

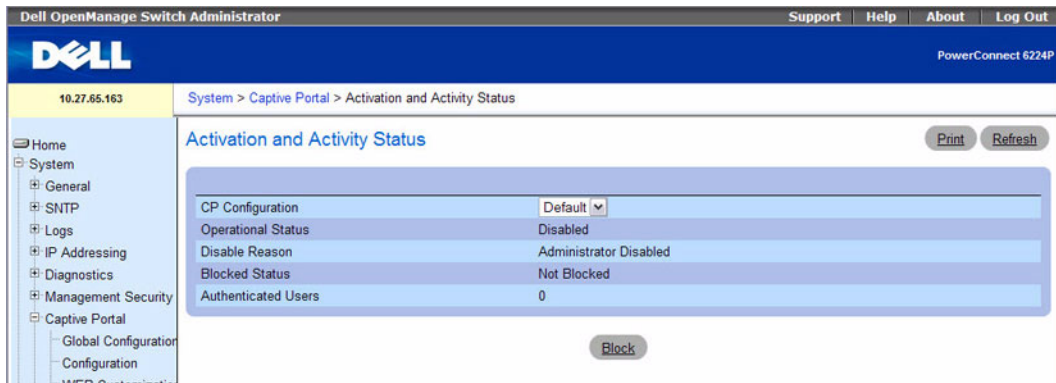

The CP Activation and Activity Status page contains the following fields:

- **CP Configuration** — Select the CP configuration with the information to view.
- **Operational Status** — Indicates whether the captive portal is enabled or disabled.
- **Disable Reason** — If the captive portal is disabled, then this field indicates the reason. The portal instance may be disabled for the following reasons:
 - None — CP is enabled.
 - Administrator Disabled
 - RADIUS Authentication mode enabled, but RADIUS server is not defined.
 - Not associated with any interfaces.
 - The associated interfaces do not exist or do not support the CP capability.
- **Blocked Status** — Indicates whether authentication attempts to the captive portal are currently blocked.

Use the Block and Unblock buttons to control the blocked status. If the CP is blocked, users cannot gain access to the network through the CP. Use this function to temporarily protect the network during unexpected events, such as denial of service attacks.

- **Authenticated Users** — Shows the number of users that successfully authenticated to this captive portal and are currently using the portal.

The following buttons are available on the CP Activation and Activity page:

- **Block**—Click Block to prevent users from gaining access to the network through the selected captive portal.
- **Unblock**—If the Blocked Status of the selected captive portal is Blocked, click Unblock to allow access to the network through the captive portal.

Interface Activation Status

The **Interface Activation Status** page shows information for every interface assigned to a captive portal instance.

To view interface activation status information, click **System** → **Captive Portal** → **Interface Activation Status**.

Figure 6-79. Interface Activation Status

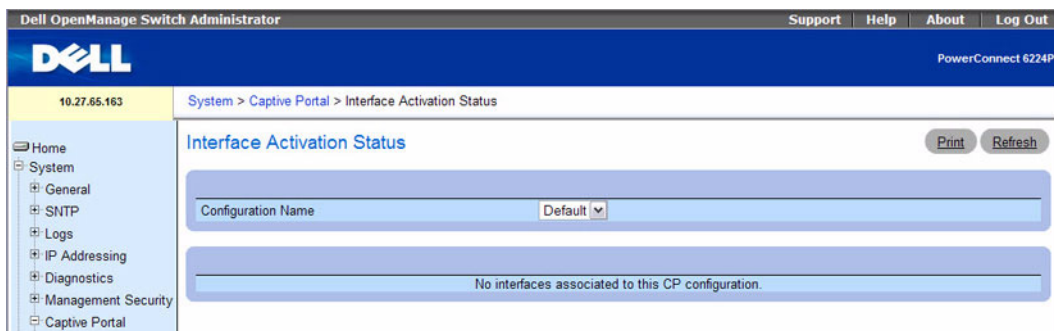

The **Interface Activation Status** page contains the following fields:

- **Configuration Name** — Select the CP configuration with the information to view.
- **Operational Status** — Shows whether the portal is active on the specified interface.
- **Disable Reason** — If the selected CP is disabled on this interface, this field indicates the reason, which can be one of the following:
 - Interface Not Attached
 - Disabled by Administrator
- **Blocked Status** — Indicates whether the captive portal is temporarily blocked for authentications.
- **Authenticated Users** — Displays the number of authenticated users using the captive portal instance on this interface.

Interface Capability Status

The **Interface Capability Status** page contains information about interfaces that can have CPs associated with them. The page also contains status information for various capabilities. Specifically, this page indicates what services are provided through the CP to clients connected on this interface. The list of services is determined by the interface capabilities.

To view interface activation status information, click **System** → **Captive Portal** → **Interface Capability Status**.

Figure 6-80. Interface Capability Status

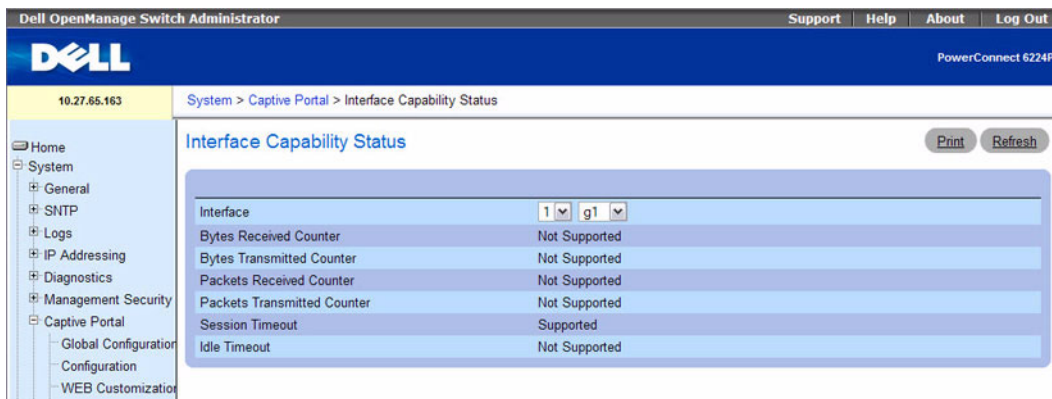

The **Interface Capability Status** page contains the following fields:

- **Interface** — Select the interface with the information to view.
- **Bytes Received Counter** — Shows whether the interface supports displaying the number of bytes received from each client.
- **Bytes Transmitted Counter** — Shows whether the interface supports displaying the number of bytes transmitted to each client.
- **Packets Received Counter** — Shows whether the interface supports displaying the number of packets received from each client.
- **Packets Transmitted Counter** — Shows whether the interface supports displaying the number of packets transmitted to each client.
- **Session Timeout** — Shows whether the interface supports client session timeout. This attribute is supported on all interfaces.
- **Idle Timeout** — Shows whether the interface supports a timeout when the user does not send or receive any traffic.

Client Summary

Use the **Client Summary** page to view summary information about all authenticated clients that are connected through the captive portal. From this page, you can manually force the captive portal to disconnect one or more authenticated clients. The list of clients is sorted by client MAC address.

To view information about the clients connected to the switch through the captive portal, click **System** → **Captive Portal** → **Client Connection Status**.

Figure 6-81. Client Summary

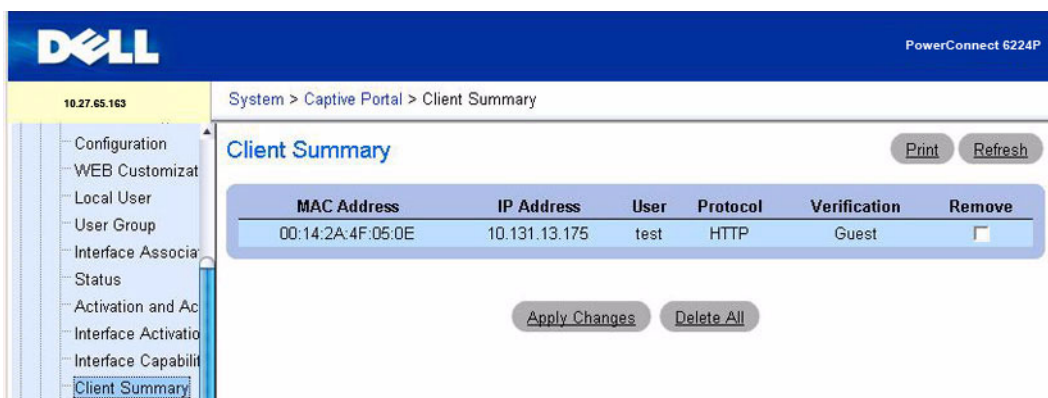

The **Client Summary** page contains the following fields:

- **MAC Address** — Identifies the MAC address of the client (if applicable).
- **IP Address** — Identifies the IP address of the client (if applicable).
- **User** — Displays the user name (or Guest ID) of the connected client.
- **Protocol** — Shows the current connection protocol, which is either HTTP or HTTPS.
- **Verification** — Shows the current account type, which is Guest, Local, or RADIUS.

To force the captive portal to disconnect an authenticated client, select the **Remove** check box next to the client MAC address and click **Apply Changes**. To disconnect all clients from all captive portals, click **Delete All**.

Client Detail

The **Client Detail** page shows detailed information about each client connected to the network through a captive portal.

To view detailed information about the clients connected to the switch through the captive portal, click **System** → **Captive Portal** → **Client Detail**.

Figure 6-82. Client Detail

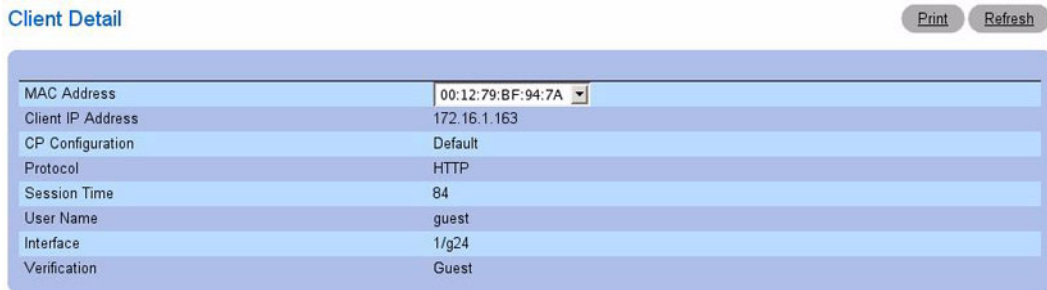

The screenshot shows a web interface titled "Client Detail" with "Print" and "Refresh" buttons. Below the title is a table with the following data:

MAC Address	00:12:79:BF:94:7A
Client IP Address	172.16.1.163
CP Configuration	Default
Protocol	HTTP
Session Time	84
User Name	guest
Interface	1/g24
Verification	Guest

The **Client Detail** page contains the following fields:

- **MAC Address** — The menu lists each associated client by MAC address. To view status information for a different client, select its MAC address from the list.
- **Client IP Address** — Identifies the IP address of the client (if applicable).
- **CP Configuration** — Identifies the CP configuration the client is using.
- **Protocol** — Shows the current connection protocol, which is either HTTP or HTTPS.
- **Session Time** — Shows the amount of time that has passed since the client was authorized.
- **User Name** — Displays the user name (or Guest ID) of the connected client.
- **Interface** — Identifies the interface the client is using.
- **Verification** — Shows the current account type, which is Guest, Local, or RADIUS.

CP Interface Client Status

Use the **Interface Client Status** page to view clients that are authenticated to a specific interface. To view statistical information for clients connected to the switch through the captive portal, click **System** → **Captive Portal** → **Interface Client Status**.

Figure 6-83. Interface - Client Status

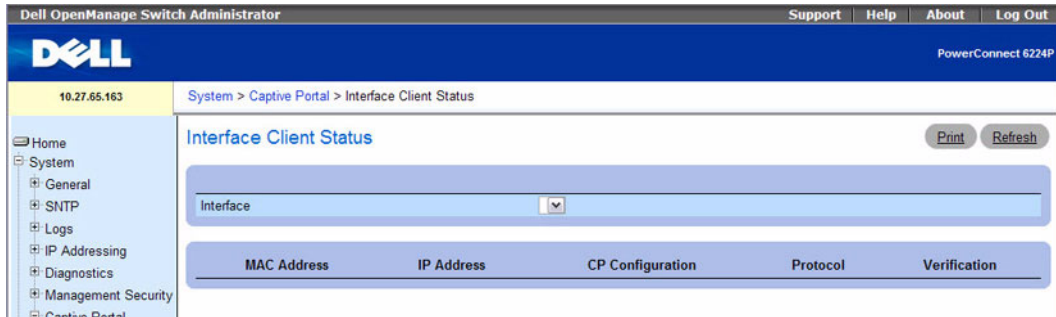

The **Interface Client Status** page contains the following fields:

- **Interface** — The drop-down menu lists each interface on the switch. To view information about the clients connected to a CP on this interface, select it from the list.
- **MAC Address** — Identifies the MAC address of the client.
- **IP Address** — Identifies the IP address of the client.
- **CP Configuration** — Identifies the captive portal the client used to access the network.
- **Protocol** — Shows the current connection protocol, which is either HTTP or HTTPS.
- **Verification** — Shows the current account type, which is Guest, Local, or RADIUS.

CP Client Status

Use the **Client Status** page to view clients that are authenticated to a specific CP configuration.

To view information about clients connected to the switch through the a specific captive portal, click **System** → **Captive Portal** → **Client Status**.

Figure 6-84. CP - Client Status

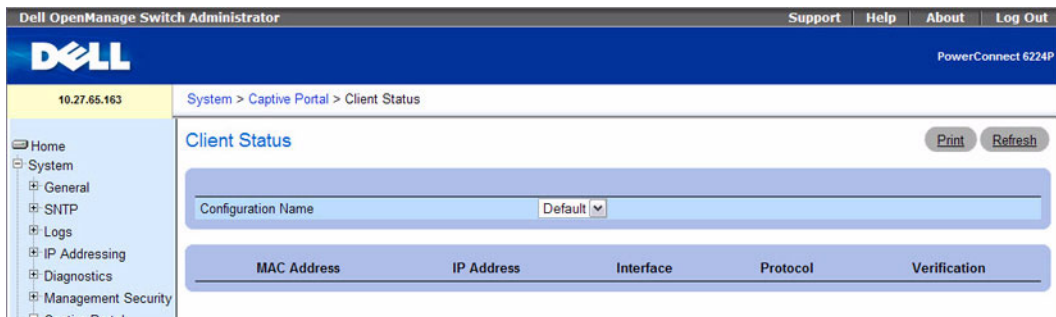

The **CP - Client Status** page contains the following fields:

- **Configuration Name** — The drop-down menu lists each CP configured on the switch. To view information about the clients connected to the CP configuration, select the CP configuration name from the list.
- **MAC Address** — Identifies the MAC address of the client.
- **IP Address** — Identifies the IP address of the client.
- **Interface** — Identifies the interface the client used to access the network.
- **Protocol** — Shows the current connection protocol, which is either HTTP or HTTPS.
- **Verification** — Shows the current account type, which is Guest, Local, or RADIUS.

Configuring Captive Portal Settings Using CLI Commands

For information about the CLI commands that perform this function, see the Captive Portal Commands chapter in the *CLI Reference Guide*. The following table summarizes the equivalent CLI commands you use to configure Captive Portal.

Table 6-39. Captive Portal Configuration Commands

CLI Command	Description
authentication timeout	Configures the authentication timeout.
captive-portal	Enables the captive portal configuration mode.
http port	Configures an additional HTTP port for captive portal to monitor.
https port	Configures an additional HTTPS port for captive portal to monitor.
show captive-portal	Displays the status of captive portal.
show captive-portal status	Reports the status of all captive portal instances in the system.
block	Blocks all traffic for a captive portal configuration.
configuration	Enables the captive portal instance mode.
enable	Globally enables captive portal.
group	Configures the group number for a captive portal configuration.
interface	Associates an interface with a captive portal configuration.
locale	Associates an interface with a captive portal configuration.
name	Configures the name for a captive portal configuration.
protocol	Configures the protocol mode for a captive portal configuration.
redirect	Enables the redirect mode for a captive portal configuration.
redirect-url	Configures the redirect URL for a captive portal configuration.
session-timeout	Configures the session timeout for a captive portal configuration.
verification	Configures the verification mode for a captive portal configuration.

Table 6-39. Captive Portal Configuration Commands (continued)

CLI Command	Description
captive-portal client deauthenticate	Deauthenticates a specific captive portal client.
show captive-portal client status	Displays client connection details or a connection summary for connected captive portal users.
show captive-portal configuration client status	Displays the clients authenticated to all captive portal configurations or a to specific configuration.
show captive-portal interface client status	Displays information about clients authenticated on all interfaces or a specific interface.
show captive-portal interface configuration status	Displays the clients authenticated to all captive portal configurations or a to specific configuration.
clear captive-portal users	Deletes all captive portal user entries.
no user	Deletes a user from the local user database.
show captive-portal user	Displays all configured users or a specific user in the captive portal local user database.
user idle-timeout	Sets the session idle timeout value for a captive portal user.
user name	Modifies the user name for a local captive portal user.

Defining SNMP Parameters

Simple Network Management Protocol (SNMP) provides a method for managing network devices. The device supports SNMP version 1, SNMP version 2, and SNMP version 3.

 **NOTE:** By default, SNMPv2 is automatically enabled on the device. To enable SNMPv3, a local engine ID must be defined for the device. The local engineID is by default set to the switch MAC address, however when the switch operates in a stacking mode, it is important to manually configure the local engineID for the stack. This local engineID must be defined so that it is unique within the network. It is important to do this because the default engineID in a stack is the MAC address of the master unit, which may change if the master unit fails and another unit takes over the stack. For information on how to configure the local engine ID, see "SNMP Global Parameters."

SNMP v1 and v2

The SNMP agent maintains a list of variables, which are used to manage the device. The variables are defined in the Management Information Base (MIB). The MIB presents the variables controlled by the agent. The SNMP agent defines the MIB specification format, as well as the format used to access the information over the network. Access rights to the SNMP agent are controlled by access strings.

SNMP v3

SNMP v3 also applies access control and a new traps mechanism to SNMPv1 and SNMPv2 PDUs. In addition, the User Security Model (USM) is defined for SNMPv3 and includes:

- **Authentication** — Provides data integrity and data origin authentication.
- **Privacy** — Protects against disclosure of message content. Cipher-Block-Chaining (CBC) is used for encryption. Either authentication is enabled on an SNMP message, or both authentication and privacy are enabled on an SNMP message. However privacy cannot be enabled without authentication.
- **Timeliness** — Protects against message delay or message redundancy. The SNMP agent compares incoming message to the message time information.
- **Key Management** — Defines key generation, key updates, and key use.

The device supports SNMP notification filters based on Object IDs (OID). OIDs are used by the system to manage device features. SNMP v3 supports the following features:

- Security
- Feature Access Control
- Traps

Authentication or Privacy Keys are modified in the SNMPv3 User Security Model (USM).

Use the **SNMP** page to define SNMP parameters. To display the **SNMP** page, click **System** → **SNMP** in the tree view.

SNMP Global Parameters

Use the **Global Parameters** page to enable SNMP and Authentication notifications.

To display the Global Parameters page, click System →SNMP →Global Parameters in the tree view.

Figure 6-85. Global Parameters

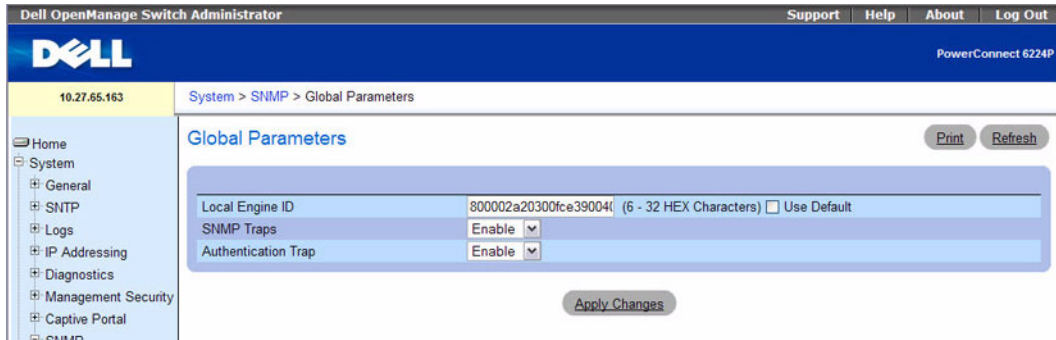

The Global Parameters page contains the following parameters:

- **Local Engine ID (6 – 32 hexadecimal characters)** — Sets local SNMP engine ID.
- **Use Default** — Configures the device to use the default SNMP EngineID.
- **SNMP Traps** — Enables or disables the device sending SNMP notifications.
- **Authentication Trap** — Enables or disables the device sending SNMP traps when authentication fails.

Setting Local SNMP Engine ID

1. Open the Global Parameters page.
2. Type desired hexadecimal ID into the Local Engine ID field.
3. Click Apply Changes.

The new Local Engine ID is set, and the device is updated.

Using Default SNMP Engine ID

1. Open the Global Parameters page.
2. Click the Use Default check box.
3. Click Apply Changes.

The default SNMP engine ID, based on the MAC address, is created and the device is updated.

Enabling SNMP Traps

1. Open the Global Parameters page.
2. Select Enable in the SNMP Traps field.
3. Click Apply Changes.

SNMP notifications are enabled, and the device is updated.

Enabling Authentication Trap

1. Open the **Global Parameters** page.
2. Select **Enable** in the **Authentication trap** field.
3. Click **Apply Changes**.

Authentication notifications are enabled, and the device is updated.

Enabling SNMP Notifications Using CLI Commands

For information about the CLI commands that perform this function, see the SNMP Commands chapter in the *CLI Reference Guide*. The following table summarizes the equivalent CLI commands you use to enable SNMP notifications.

Table 6-40. SNMP Notifications Commands

CLI Command	Description
show snmp engineID	Displays the SNMP engine ID.
show snmp engineid	Displays the SNMP engine ID.
show trapflags	Shows the status of the configurable SNMP traps.
snmp-server enable traps	Enables SNMP traps globally or enables specific SNMP traps.
snmp-server engineID local	Specifies the Simple Network Management Protocol (SNMP) engine ID on the local switch.

SNMP View Settings

Use this page to create views that define which features of the device are accessible, and which are blocked. You can create a view that includes or excludes OIDs corresponding to interfaces.

Use the **SNMP View Settings** page to define SNMP views.

To display the **SNMP View Settings** page, click **System** → **SNMP** → **View Settings** in the tree view.

Figure 6-86. SNMP View Settings

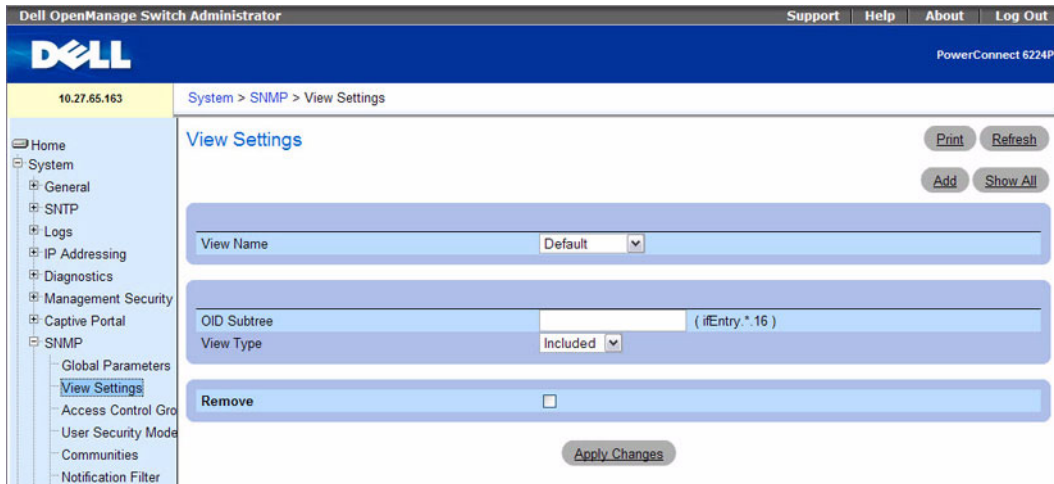

The SNMP View Settings page contains the following fields:

- **View Name** — Contains a list of user-defined views. A view name can contain a maximum of 30 alphanumeric characters.
- **OID Subtree** — Specifies a valid SNMP OID string that can include meta characters like *.
- **View Type** — Specifies whether the objectIDs in the view are included or excluded.
- **Remove** — Check to remove displayed view type.

Adding a View

1. Open the SNMP View Settings page.
2. Click Add.

The Add View page displays:

Figure 6-87. Add View

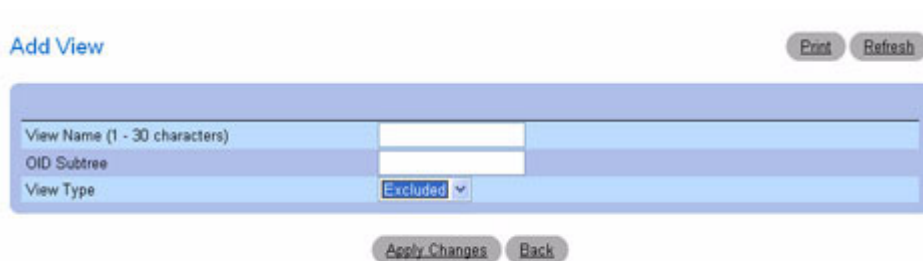

3. Define the relevant fields.
4. Click **Apply Changes**.
The SNMP view is added, and the device is updated.

Displaying the View Table

1. Open the **SNMP View Settings** page.
2. Click **Show All**.

The **View Table** page displays:

Figure 6-88. View Table

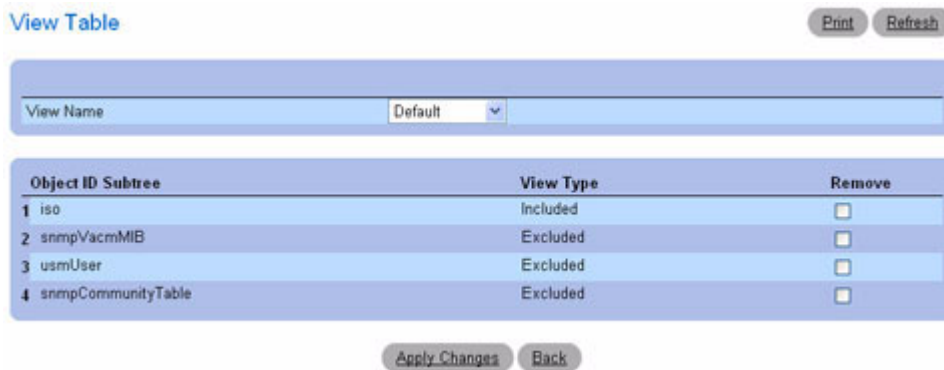

Removing SNMP Views

1. Open the **SNMP View Settings** page.
2. Click **Show All**.
The **View Table** page displays.
3. Select an SNMP view.
4. Check the **Remove** check box.
5. Click **Apply Changes**.
The SNMP view is removed, and the device is updated.

Defining SNMP Views Using CLI Commands

For information about the CLI commands that perform this function, see the **SNMP Commands** chapter in the *CLI Reference Guide*. The following table summarizes the equivalent CLI commands you use to define SNMP views.

Table 6-41. SNMP Views Commands

CLI Command	Description
show snmp views	Displays the configuration of views.
snmp-server view	Creates or updates an SNMP server view entry.

Access Control Group

Use the **Access Control Group** page to view information for creating SNMP groups, and to assign SNMP access privileges. Groups allow network managers to assign access rights to specific device features or features aspects.

To display the **Access Control Group** page, click **System** → **SNMP** → **Access Control** in the tree view.

Figure 6-89. Access Control Group

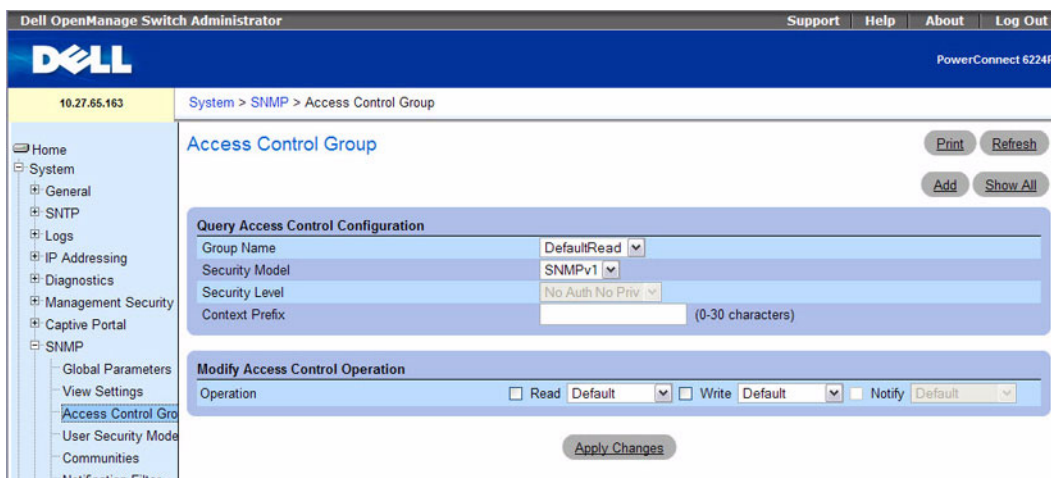

The **Access Control Group** page contains the following fields:

- **Group Name** — Contains a list of user-defined groups to which access control rules are applied. A group name can contain a maximum of 30 alphanumeric characters.
- **Security Model** — Defines the SNMP version attached to the group. The possible field values are:
 - **SNMPv1** — SNMPv1 is defined for the group.
 - **SNMPv2** — SNMPv2 is defined for the group.
 - **SNMPv3** — SNMPv3 User Security Model (USM) is defined for the group.
- **Security Level** — The security level attached to the group. Security levels apply to SNMPv3 groups only. The possible field values are:
 - **noauth no priv** — Neither Authentication nor Privacy security levels are assigned to the group.

- **auth nopriv** — Authenticates SNMP messages without encrypting them.
- **auth priv** — Authenticates SNMP messages and encrypts them.
- **Context Prefix (1-30)** — This field permits the user to specify the context name by entering the first 1 to 30 characters of the context name.
- **Operation** — Defines group access rights. The possible field values are:
 - **Read** — Select a view that restricts management access to viewing the contents of the agent. If no view is selected, all objects except the community-table, SNMPv3 user and access tables can be viewed.
 - **Write** — Select a view that permits management read-write access to the contents of the agent.
 - **Notify** — Select a view that permits sending SNMP traps or informs.

Adding SNMP Groups

1. Open the Access Control Configuration page.
2. Click Add.

The Add an Access Control Configuration page displays:

Figure 6-90. Add an Access Control Configuration

3. Define the fields as needed.
4. Click **Apply Changes**.
The group is added, and the device is updated.

Displaying the Access Table

1. Open the Access Control Configuration page.
2. Click Show All.

The Access Table page displays:

Figure 6-91. Access Table

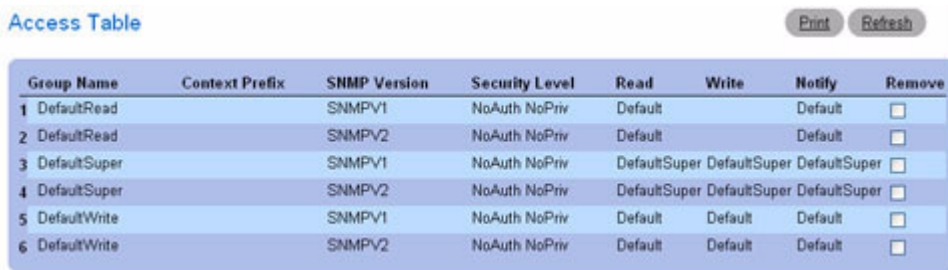

Group Name	Context Prefix	SNMP Version	Security Level	Read	Write	Notify	Remove
1 DefaultRead		SNMPV1	NoAuth NoPriv	Default		Default	<input type="checkbox"/>
2 DefaultRead		SNMPV2	NoAuth NoPriv	Default		Default	<input type="checkbox"/>
3 DefaultSuper		SNMPV1	NoAuth NoPriv	DefaultSuper	DefaultSuper	DefaultSuper	<input type="checkbox"/>
4 DefaultSuper		SNMPV2	NoAuth NoPriv	DefaultSuper	DefaultSuper	DefaultSuper	<input type="checkbox"/>
5 DefaultWrite		SNMPV1	NoAuth NoPriv	Default	Default	Default	<input type="checkbox"/>
6 DefaultWrite		SNMPV2	NoAuth NoPriv	Default	Default	Default	<input type="checkbox"/>

Removing a Group

1. Open the Access Control Configuration page.
2. Click Show All.
The Access Table opens.
3. Select a group.
4. Check Remove.
5. Click Apply Changes.

The group is removed, and the device is updated.

Defining SNMP Access Control Using CLI Commands

For information about the CLI commands that perform this function, see the SNMP Commands chapter in the *CLI Reference Guide*. The following table summarizes the equivalent CLI commands you use to define SNMP Access Control.

Table 6-42. SNMP Access Control Commands

CLI Command	Description
snmp-server group	Configures a new SNMP group or a table that maps SNMP users to SNMP views.
snmp-server community-group	Maps SNMP v1 and v2 security models to the group name.
show snmp groups	Displays the configuration of groups.

SNMPv3 User Security Model (USM)

Use the SNMPv3 User Security Model (USM) page to assign system users to SNMP groups and to define the user authentication method.

To display the SNMPv3 User Security Model (USM) page, click System →SNMP →User Security Model in the tree view.

Figure 6-92. SNMPv3 User Security Model (USM)

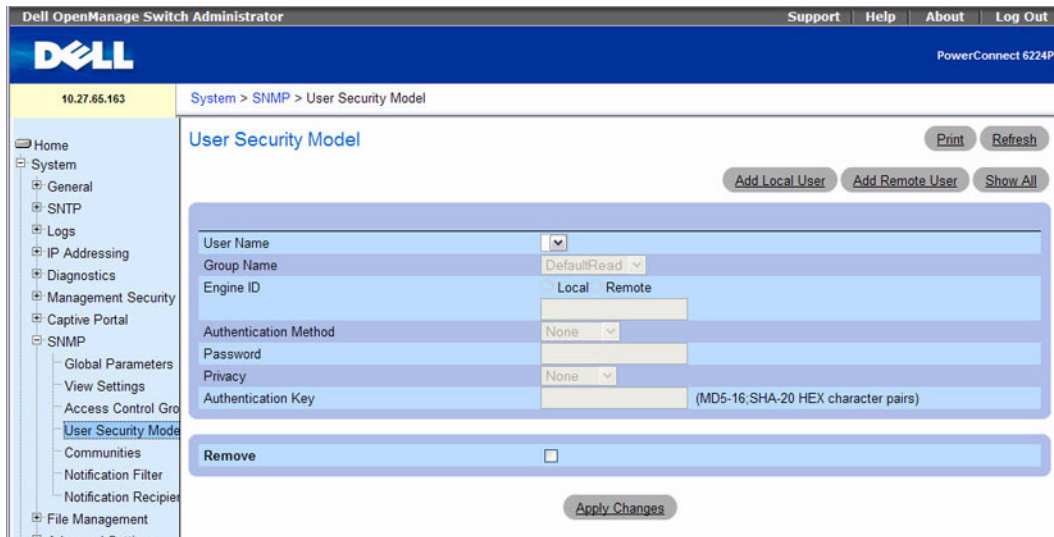

The SNMPv3 User Security Model (USM) page contains the following fields:

- **User Name** — Contains a list of user-defined user names.
- **Group Name** — Contains a list of user-defined SNMP groups. SNMP groups are defined in the **Access Control Group** page.
- **Engine ID** — Selects whether the selected user is associated to a local or to a specified remote SNMPv3 enabled device.
 - **Remote Engine ID** — Indicates that the user is configured on a remote SNMPv3 enabled device.
- **Authentication Method** — Specifies the authentication method used to authenticate users. The possible field values are:
 - **None** — No user authentication is used.
 - **MD5** — Users are authenticated using the HMAC-MD5-96 authentication level. The user should specify a password.
 - **SHA** — Users are authenticated using the HMAC-SHA-96 authentication level. The user should enter a password.
- **Password** — Modifies the user defined password for the group. Passwords can contain a maximum of 32 characters. Passwords are defined only if the authentication method is MD5 or SHA Password. You define the password on the **Add Local User** page.
- **Privacy** — Specifies whether or not the authentication key is to be used. Choose one of the following values:
 - **None** — Do not use an authentication key.

- **des** — Use a CBC-DES Symmetric Encryption Password for the authentication key.
- **des-key** — Use an HMAC-MD5-96 Authentication Pre-generated key.
- **Authentication Key(MD5-16; SHA-20 HEX character pairs)** — Specify the authentication key. An authentication key is defined only if the authentication method is MD5 or SHA.
- **Remove** — Removes the specified user from the specified group when checked.

Adding SNMPv3 Local Users to a Group

1. Open the SNMPv3 User Security Model page.
2. Click Add Local User.

The Add Local User page displays:

Figure 6-93. Add Local User

LocalEngineId	800002a20300fce3900145
User Name (1 - 32 characters)	<input type="text"/>
Group Name	DefaultRead
Authentication Method	None
Password (1-32 characters)	<input type="text"/>
Privacy	None
Authentication Key (MD5-16,SHA-20 HEX character pairs)	<input type="text"/>

3. Define the relevant fields.
4. Click Apply Changes.
5. The user is added to the group, and the device is updated.

Adding SNMPv3 Remote Users to a Group

1. Open the SNMPv3 User Security Model page.
2. Click Add Remote User.

The Add Remote User page displays:

Figure 6-94. Add Remote User

Add Remote User Print Refresh

Remote Engine ID (6 - 32 HEX Characters)	<input type="text"/>
User Name (1-32 characters)	<input type="text"/>
Group Name	DefaultRead <input type="button" value="v"/>
Authentication Method	None <input type="button" value="v"/>
Password (1-32 characters)	<input type="text"/>
Privacy	None <input type="button" value="v"/>
Authentication Key (MD5-16,SHA-20 HEX character pairs)	<input type="text"/>

Apply Changes Back

3. Define the relevant fields.
4. Click **Apply Changes**.
5. The user is added to the group, and the device is updated.

Viewing the User Security Model Table

1. Open the SNMPv3 User Security Model (USM) page.
2. Click **Show All**.

The User Security Model Table displays:

Figure 6-95. User Security Model Table

User Security Model Table Print Refresh

User Name	Group Name	Remote Engine ID	Authentication	Remove
1 Admin	DefaultRead	800002a20300fce3900145	NONE	<input type="checkbox"/>
2 pippin	DefaultRead	800002a20300fce3900145	NONE	<input type="checkbox"/>
3 gandalf	DefaultRead	800002a20300fce3900145	NONE	<input type="checkbox"/>

Apply Changes Back

Removing a User Security Model Table Entry

1. Open the User Security Model page.
2. Click **Show All**.
The User Security Model Table page displays.
3. Select an entry.

4. Check the **Remove** check box.
5. Click **Apply Changes**.

The entry is removed, and the device is updated.

Defining SNMP Users Using CLI Commands

For information about the CLI commands that perform this function, see the SNMP Commands chapter in the *CLI Reference Guide*. The following table summarizes the equivalent CLI commands you use to define SNMP users.

Table 6-43. SNMP Users Commands

CLI Command	Description
show snmp users	Displays the configuration of users.
snmp-server user	Configures a new SNMP Version 3 user.

Communities

Access rights are managed by defining communities on the **SNMPv1, 2 Community** page. When the community names are changed, access rights are also changed. SNMP Communities are defined only for SNMP v1 and SNMP v2.

To display the **SNMPv1, 2 Community** page, click **System** → **SNMP** → **Communities** in the tree view.

Figure 6-96. SNMPv1, 2 Community

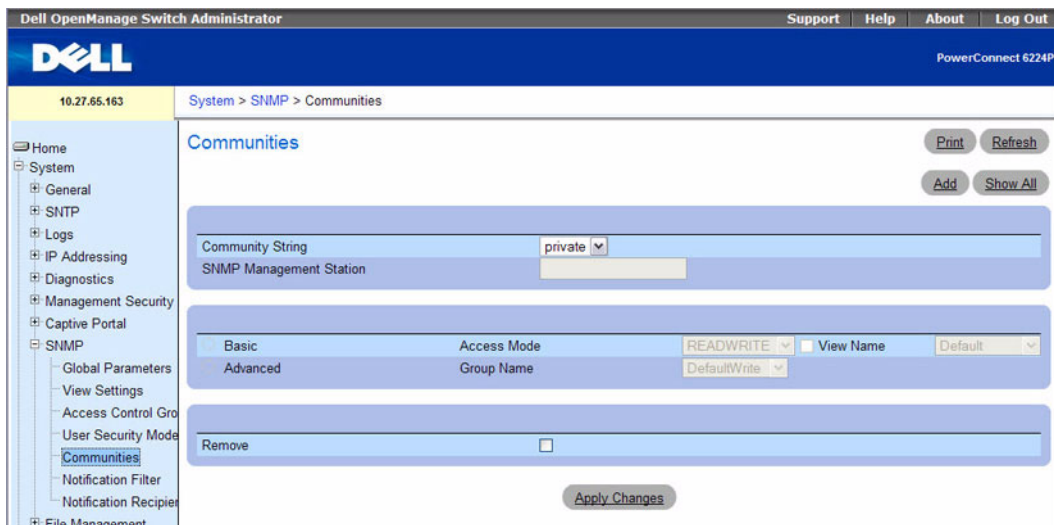

The **SNMPv1, 2 Community** page contains the following fields:

- **Community String** — Contains a list of user-defined community strings that act as a password and are used to authenticate the SNMP management station to the device. A community string can contain a maximum of 20 characters.
- **SNMP Management Station** — Contains a list of management station IP address for which community strings have been defined.
- **Basic** — Enables SNMP Basic mode for the selected community. The possible field values are:
 - **Access Mode** — Defines the access rights of the community. The possible field values are:
 - **Read-Only** — Community has read only access to the MIB objects configured in the view.
 - **Read-Write** — Community has read/modify access to the MIB objects configured in the view.
 - **Super User** — Community has read/modify access to all MIB objects.
 - **View Name** — Contains a list of user-defined SNMP views.
- **Advanced** — Contains a list of user-defined groups. When SNMP Advanced mode is selected, the SNMP access control rules comprising the group are enabled for the selected community. The Advanced mode also enables SNMP groups for specific SNMP communities. The SNMP Advanced mode is defined only with SNMPv3.
- **Remove** — When checked, removes a community.

Adding a New Community

1. Open the SNMPv1, 2 Community page.
2. Click Add.

The Add SNMPv1,2 Community page displays:

Figure 6-97. Add SNMPv1,2 Community

3. Complete the relevant fields.

In addition to the fields in the **SNMPv1, 2 Community** page, the **Add SNMPv1,2 Community** page contains the **All (0.0.0.0)** field, which indicates that the community can be used from any management station.

4. Click **Apply Changes**.

The new community is saved, and the device is updated.

Displaying Communities

1. Open the **SNMPv1, 2 Community** page.
2. Click **Show All**.

The **Basic and Advanced Table** page displays.

Figure 6-98. Basic and Advanced Table

The screenshot shows two tables on a web interface. The top table is titled "Basic Table" and has columns for Management Station, Community String, Access Mode, View Mode, and Remove. The bottom table is titled "Advanced Table" and has columns for Community String, Management Station, and Group Name. Both tables have two rows of data. The "Basic Table" has a "Remove" column with checkboxes. The "Advanced Table" has an "Apply Changes" button and a "Back" button below it.

Basic Table				
Management Station	Community String	Access Mode	View Mode	Remove
1 All	private	Read Only	Default	<input type="checkbox"/>
2 All	public	Read Write	Default	<input type="checkbox"/>

Advanced Table		
Community String	Management Station	Group Name
1 private	All	DefaultRead
2 public	All	DefaultWrite

Removing Communities

1. Open the **SNMPv1, 2 Community** page.
2. Click **Show All**.
3. Select a community and check the **Remove** check box.
4. Click **Apply Changes**.

The community entry is removed, and the device is updated.

Configuring Communities Using CLI Commands

For information about the CLI commands that perform this function, see the SNMP Commands chapter in the *CLI Reference Guide*. The following table summarizes the equivalent CLI commands you use to configure SNMP communities.

Table 6-44. SNMP Communities Commands

CLI Command	Description
show snmp	Displays the SNMP status.
snmp-server community	Sets up the community access string to permit access to SNMP protocol.
snmp-server community-group	Maps SNMP v1 and v2 security models to the group name.

Notification Filter

Use the **Notification Filter** page to set filtering traps based on OIDs. Each OID is linked to a device feature or a feature aspect. The **Notification Filter** page also allows you to filter notifications.

To display the **Notification Filter** page, click **System** → **SNMP** → **Notification Filters** in the tree view.

Figure 6-99. Notification Filter

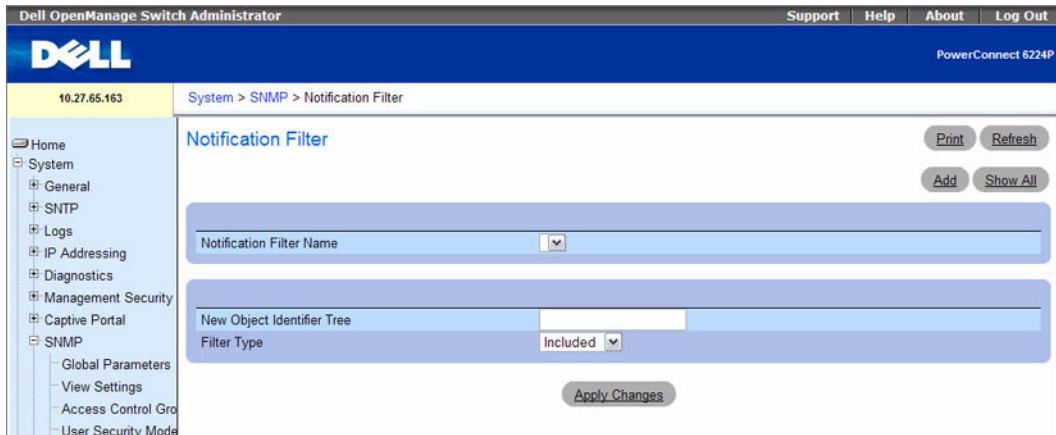

The **Notification Filter** page contains the following fields:

- **Notification Filter Name** — Contains a list of user-defined notification filters. A notification filter name can contain a maximum of 30 characters.
- **New Object Identifier Tree** — Displays the OID configured for the selected filter. This field can be edited.
- **Filter Type** — Indicates whether informs or traps are sent regarding the OID to the trap recipients.

- **Excluded** — Restricts sending OID traps or informs.
- **Included** — Sends OID traps or informs.

Adding SNMP Filters

1. Open the **Notification Filter** page.
2. Click **Add**.

The **Add Filter** page displays:

Figure 6-100. Add Filter

Filter Name (1 - 30 characters)	UserFilter1
New Object Identifier Tree	1.3.6.1.2.1.1.7
Filter Type	Included

3. Define the relevant fields.
4. Click **Apply Changes**.

The new filter is added, and the device is updated.

Displaying the Filter Table

1. Open the **Notification Filter** page.
2. Click **Show All**.

The **Filter Table** page appears, which displays all of the filters configured for the selected filter name:

Figure 6-101. Show Notification

Object ID Subtree	Filter Type	Remove
-------------------	-------------	--------

Removing a Filter

1. Open the **Notification Filter** page.

2. Click **Show All**.

The **Show Notification** page displays.

3. Select the **Filter Table** entry.

4. Check **Remove**.

The filter entry is removed, and the device is updated.

Configuring Notification Filters Using CLI Commands

For information about the CLI commands that perform this function, see the **SNMP Commands** chapter in the *CLI Reference Guide*. The following table summarizes the equivalent CLI commands you use to configure notification filters.

Table 6-45. Notification Filters Configuration Commands

CLI Command	Description
show snmp filters	Displays the configuration of filters.
snmp-server filter	Creates or updates an SNMP server filter entry.

Notification Recipients

Use the **Notification Recipients** page to view information for defining filters that determine whether traps are sent to specific users, and the trap type sent. SNMP notification filters provide the following services:

- Identifying Management Trap Targets
- Trap Filtering
- Selecting Trap Generation Parameters
- Providing Access Control Checks

To display the **Notification Recipients** page, click **System** → **SNMP** → **Notification Recipient** in the tree view.

Figure 6-102. Notification Recipients

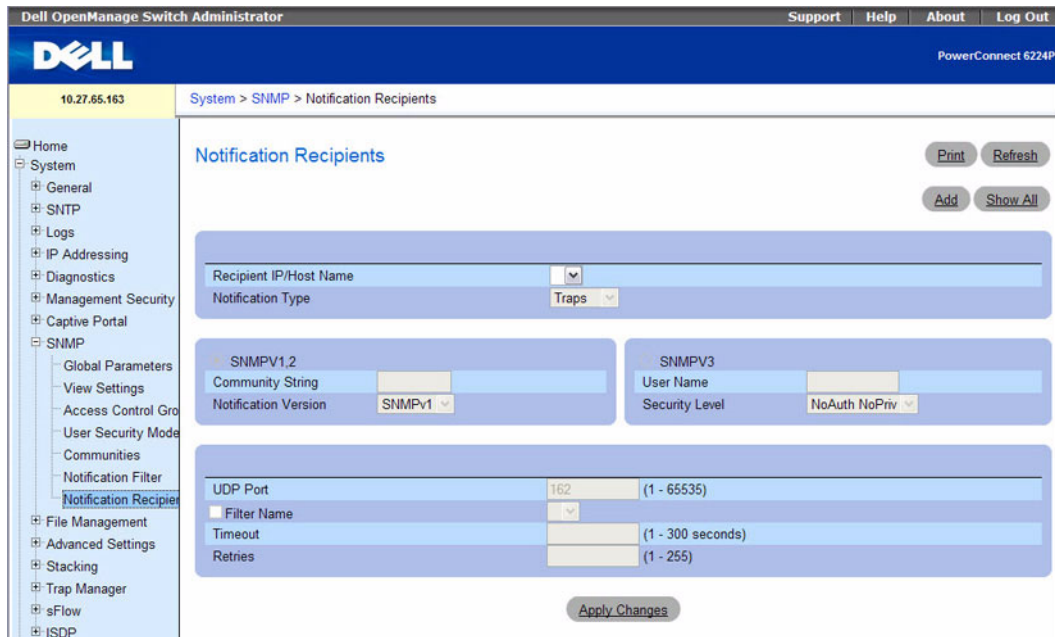

The Notification Recipients page contains the following fields:

- **Recipient IP** — Contains a user-defined list of notification recipients IP addresses.
- **Notification Type** — The type of notification sent. The possible field values are:
 - **Trap** — Traps are sent.
 - **Inform** — Informs are sent.
- **SNMPv1,2** — SNMP versions 1 or 2 are enabled for the selected recipient. The possible field values are:
 - **Community String** — Displays the community string to be sent with the notification.
 - **Notification Version** — Determines the notification version. The possible field values are:
 - **SNMP V1** — SNMP version 1 traps are sent. If Inform is selected as the Notification Type, SNMPv1 cannot be selected.
 - **SNMP V2** — SNMP version 2 traps or informs are sent.
- **SNMPv3** — SNMP version 3 is enabled for the selected recipient. The possible field values are:
 - **User Name** — Select the existing user to generate notifications.
 - **Security Level** — The security level attached to notifications. The possible field values are:
 - **NoAu NoPriv** — The packet is neither authenticated nor encrypted.

- **Auth NoPriv** — The packet is authenticated.
- **Auth Priv** — The packet is both authenticated and encrypted.
- **UDP Port (1–65535)** — UDP port used to send notifications. The default is 162.
- **Filter Name** — Check this check box to apply a user-defined SNMP filter (selected from the drop-down menu) to notifications.
- **Timeout (1–300)** — Amount of time (seconds) the device waits before resending informs. The default is 15 seconds.
- **Retries (1–255)** — Maximum number of times the device resends an inform request. The default is 3.

Adding a New Notification Recipient

1. Open the **Notification Recipients** page.
2. Click **Add**.

The **Notification Recipients** page displays:

Figure 6-103. Add Notification Recipient

Add Notification Recipient Print Refresh

Recipient IP/Host Name

Notification Type Traps

SNMPV1,2

Community String

Notification Version SNMPV1

SNMPV3

User Name

Security Level NoAuth NoPriv

UDP Port (1 - 65535)

Filter Name LVL7RTP

Timeout (1 - 300) (sec)

Retries (1 - 255)

Apply Changes Back

3. Define the relevant fields.
4. Click **Apply Changes**.

The notification recipient is added, and the device is updated.

Displaying the Notification Recipients Tables

1. Open Notification Recipients page.
2. Click Show All.

The Notification Recipient Tables page opens:

Figure 6-104. Notification Recipient Tables

The screenshot shows a web interface for managing notification recipients. At the top, there is a header "Notification Recipients Tables" with "Print" and "Refresh" buttons. Below this, there are two sections:

SNMPV1,2 Notification Recipients

Recipients IP/Host Name	Notification Type	Community String	Notification Version	UDP Port	Filter Name	Timeout	Retries	Remove
----------------------------	----------------------	---------------------	-------------------------	-------------	----------------	---------	---------	--------

SNMPV3 Notification Recipients

Recipients IP/Host Name	Notification Type	User Name	Security Level	UDP Port	Filter Name	Timeout	Retries	Remove
----------------------------	----------------------	--------------	-------------------	-------------	----------------	---------	---------	--------

At the bottom of the page, there are "Apply Changes" and "Back" buttons.

Removing Notification Recipients

1. Open the Notification Recipients page.
2. Click Show All.

The Notification Recipient Tables page open.

3. Select the **Remove** check box for one or more notification recipients in the **SNMPV1,2 Notification Recipient** and/or **SNMPv3 Notification Recipient Tables**.
4. Click **Apply Changes**.

The recipients are removed, and the device is updated.

Defining SNMP Notification Recipients Using CLI Commands

For information about the CLI commands that perform this function, see the SNMP Commands chapter in the *CLI Reference Guide*. The following table summarizes the equivalent CLI commands you use to define SNMP notification recipients.

Table 6-46. SNMP Notification Recipients Commands

CLI Command	Description
show snmp	Displays the SNMP status.
snmp-server host	Specifies the recipient of SNMP notifications.
snmp-server v3-host	Specifies the recipient of SNMPv3 notifications.

File Management

Use the **File Management** menu page to manage device software, the image file, and the configuration files. In addition to a TFTP server, the file management feature has been enhanced to allow file uploads and downloads by using an HTTP session (in other words, by using your web browser).

Configuration file transfers are also permitted by using Secure Copy (SCP) and SSH File Transfer Protocol (SFTP).

The system handles two versions of the software image. The system running an older software version will ignore (not load) a configuration file created by the newer software version. When a configuration file created by the newer software version is discovered by the system running an older version of the software, the system will display an appropriate warning to the user.

File System

Use the **File System** page to view a list of the files on the device.

To display the **File System** page, click **System** → **File Management** → **File System** in the tree view.

Figure 6-105. File System

The screenshot shows the Dell OpenManage Switch Administrator interface. The breadcrumb navigation is System > File Management > File System. The left sidebar shows the navigation tree with 'File System' selected under 'File Management'. The main content area displays a table of files in the file system and flash memory details.

File Name	Image Description (0-255 characters)	Size	Remove
1 image1	default image	10199312	<input type="checkbox"/>
2 image2		9532876	<input type="checkbox"/>
3 backup-config		2819	<input type="checkbox"/>
4 startup-config		2819	<input type="checkbox"/>

Flash Memory Details		
	Total Bytes	Free Bytes
1	2097152	4277326622

The **File System** page contains the following fields:

- **File Name** — A text field listing the names of the files on the file system.
- **Image Description** — A field 0-128 characters in length that displays an image description of the file.
- **Size** — Displays the size of the specified file in bytes.
- **Remove** — Select to remove the specified file.
- **Flash Memory Details** — Displays Flash Memory availability details, in terms of total bytes of memory used, and memory (in bytes) available.

Displaying the File System Using CLI Commands

For information about the CLI command that performs this function, see the Configuration and Image File Commands chapter in the *CLI Reference Guide*. The following table displays the equivalent CLI command you use to display system files.

Table 6-47. File System Command

CLI Command	Description
filedescr	Adds a description to a file.
show bootvar	Displays the active system image file that the switch loads at startup.
show dir	Lists all the files available on the flash file system.

Active Images

Use the **Active Images** page to set the boot image.

To display the **File System** page, click **System** → **File Management** → **Active Images** in the tree view.

Figure 6-106. Active Images

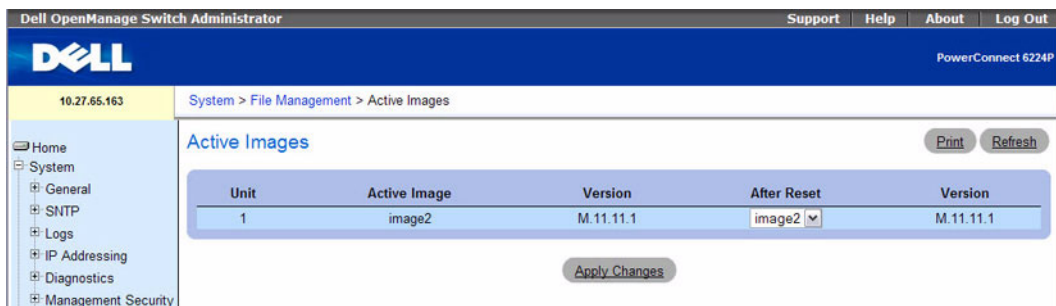

The **Active Images** page contains the following fields:

- **Unit** — The unit on which the active image is running.
- **Active Image** — The name of the current active image.

- **Version** — The version of the current active image.
- **After Reset** — From the menu, select the image that should be active after the next reset.
- **Version** — Displays the version of the image after reset.

Setting the Boot Image Using CLI Commands

For information about the CLI command that performs this function, see the Configuration and Image File Commands chapter in the *CLI Reference Guide*. The following table shows the equivalent CLI command you use to configure the boot image.

Table 6-48. Set Boot Image Command

CLI Command	Description
boot system	Specifies the system image that the switch loads at startup.

File Download

Use the **File Download** page to download image (binary) files, SSH and SSL certificates, and configuration (ASCII), files from the server to the device.

To display the **File Download** page, click **System** → **File Management** → **File Download** in the tree view.

Figure 6-107. File Download

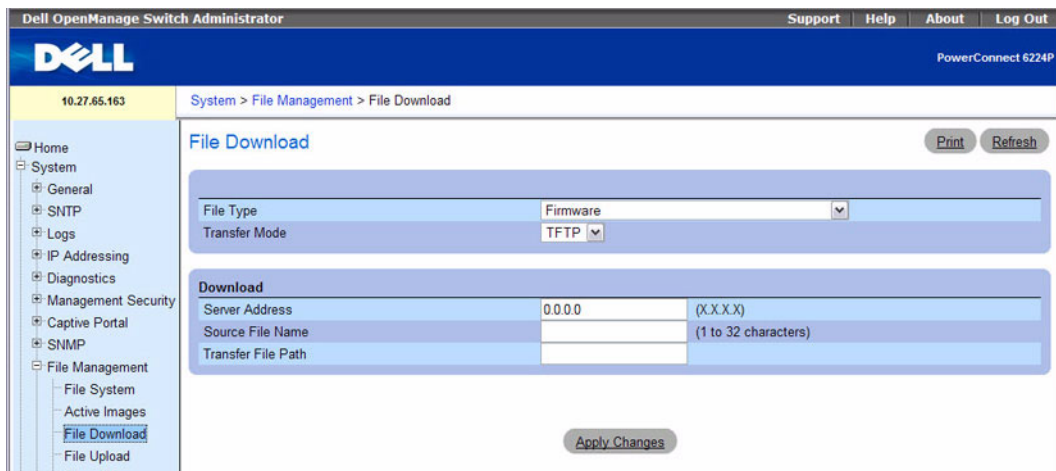

The **File Download** page contains the following fields:

File Type — Select the type of file to be downloaded. Possible filetypes are:

- **Firmware** — Downloads the active image.

- **SSH-1 RSA Key File** — SSH-1 Rivest-Shamir-Adleman (RSA) Key File
- **SSH-2 RSA Key PEM File** — SSH-2 Rivest-Shamir-Adleman (RSA) Key File (PEM Encoded)
- **SSH-2 DSA Key PEM File** — SSH-2 Digital Signature Algorithm (DSA) Key File (PEM Encoded)
-  **NOTE:** To download SSH key files, SSH must be administratively disabled and there can be no active SSH sessions.
- **SSL Trusted Root Certificate PEM File** — SSL Trusted Root Certificate File (PEM Encoded)
- **SSL Server Certificate PEM File** — SSL Server Certificate File (PEM Encoded)
- **SSL DH Weak Encryption Parameter PEM File** — SSL Diffie-Hellman Weak Encryption Parameter File (PEM Encoded)
- **SSL DH Strong Encryption Parameter PEM File** — SSL Diffie-Hellman Strong Encryption Parameter File (PEM Encoded)
- **Configuration** — Choose this option to update the switch's configuration. If the file has errors the update will be stopped. If **File Type - Configuration** and **Transfer Mode - HTTP** are selected, the **Destination File Name** field is also displayed.
- **Transfer Mode** — Select the file transfer mode for the configuration to download. The options are:
 - **TFTP** — Trivial File Transfer Protocol
 - **SFTP** — SSH File Transfer Protocol
 - **SCP** — Secure Copy
 - **HTTP** — Download files of various types to the switch using an HTTP session (in other words, by using your web browser).
- **Server Address** — Specify the TFTP/SFTP/SCP server IP address from which the configuration files are downloaded.
- **Source File Name** — Name of the file on the TFTP/SFTP/SCP server. The name can be from 1 to 32 characters.
- **Transfer File Path** — Specify the path of the file to be downloaded from the TFTP/SFTP/SCP server.
- **User Name** — Name of the user on the server. Used for authentication in case of SFTP/SCP server.
- **Password** — Password of the user on the server. Used for authentication in case of SFTP/SCP server.
- **Destination File Name** — The destination file to which to the configuration file is downloaded. Possible values are:
 - **Startup Configuration** — Downloads the startup configuration files.
 - **Backup Configuration** — Downloads the backup configuration files.
- **Select File** — Used in case of HTTP download. Enter the path and filename or browse for the file you want to download. You may enter up to 80 characters.

Click **Apply Changes** to initiate the file download.

 **NOTE:** HTTP File Download is not available by using the CLI.

Downloading Files

1. Open the **File Download From Server** page.
2. Verify the IP address of the server and ensure that the software image or boot file to be downloaded is available on the server.
3. Complete the **Server Address** and **Source File Name** (full path without server IP address) fields.
4. If you are downloading a configuration file, select the **Destination File Name**.
5. Click **Apply Changes**.



NOTE: After you start a file download, the page refreshes and a transfer status field appears to indicate the number of bytes transferred. The Web interface is blocked until the file download is complete.

6. The software is downloaded to the device.

Downloading Files Using CLI Commands

For information about the CLI commands that perform this function, see the Configuration and Image Files Commands chapter in the *CLI Reference Guide*. The following table summarizes the equivalent CLI commands you use to download files.

Table 6-49. Downloading Files Commands

CLI Command	Description
copy	Copies files from a source to a destination.

File Upload

Use the **File Upload to Server** page to upload configuration (ASCII), image (binary), operational log, and startup log files from the device to the server.

To display the **File Upload to Server** page, click **System** → **File Management** → **File Upload** in the tree view.

Figure 6-108. File Upload to Server

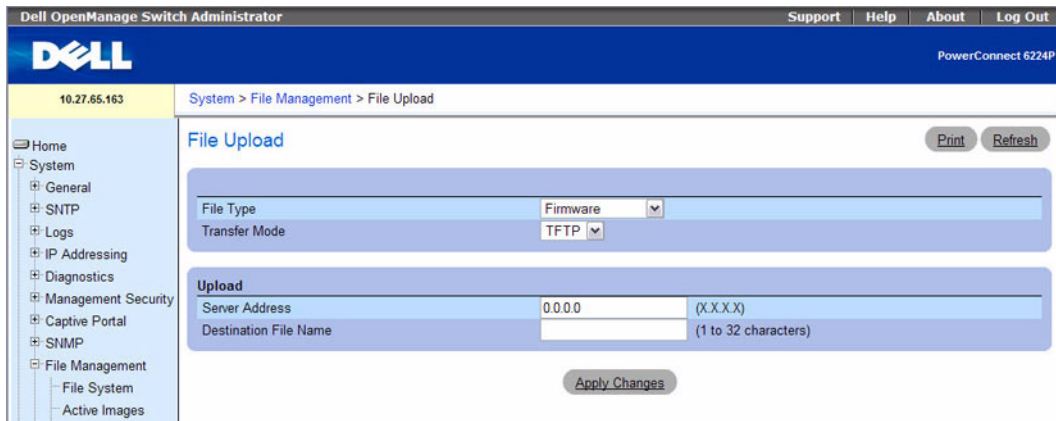

The **File Upload to Server** page contains the following fields:

- **File Type** — Select the type of file to be uploaded. Possible filetypes are:
 - **Firmware** — Uploads the active image.
 - **Configuration** — Uploads the configuration file. If **File Type - Configuration** is selected, the **Transfer File Name** field is also displayed.
 - **Startup Log** — Uploads the startup log file.
 - **Operational Log** — Uploads the operational log.
- **Transfer Mode** — Select the transfer mode to upload the file to the server. The options are:
 - **TFTP** — Trivial File Transfer Protocol
 - **SFTP** — SSH File Transfer Protocol
 - **SCP** — Secure Copy
 - **HTTP** — Hypertext Transfer Protocol

Upload

Upload contains the following fields:

- **Server Address** — The server IP address to which the selected file is uploaded.
- **Destination File Name** — The name which the file will have after it is uploaded. The name can be 1 – 32 characters.
- **User Name** — Name of the user on the server. Used for authentication in case of SFTP/SCP server.
- **Password** — Password of the user on the server. Used for authentication in case of SFTP/SCP server.
- **Transfer File Name** — Select the source configuration file to upload. Valid field values are:

- **Running Configuration** — Uploads the running configuration file.
- **Startup Configuration** — Uploads the startup configuration files.
- **Backup Configuration** — Uploads the backup configuration files.

Uploading Files

1. Open the **File Upload to Server** page.
2. Define the applicable fields in the page.
3. Click **Apply Changes**.



NOTE: After you start a file upload, the page refreshes and a transfer status field appears to indicate the number of bytes transferred. The Web interface is blocked until the file upload is complete.

4. The software is uploaded to the server.

Uploading Files Using CLI Commands

For information about the CLI commands that perform this function, see the Configuration and Image Files Commands chapter in the *CLI Reference Guide*. The following table summarizes the equivalent CLI commands you use to upload files.

Table 6-50. Uploading Files Commands

CLI Command	Description
copy	Copies files from a source to a destination.

Copy Files

The Copy Files page not only provides a method for copying files within the file system, but also to and from remote servers. You can also backup images to local or remote systems or restore images from local or remote systems.

To display the Copy Files page, click **System** → **File Management** → **Copy Files** in the tree view.

Figure 6-109. Copy Files

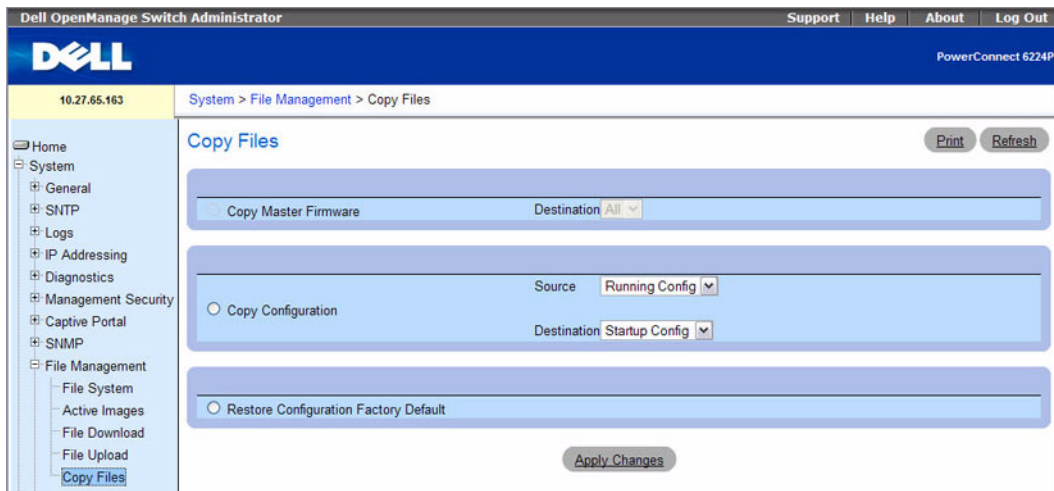

The Copy Files page contains the following fields:

- **Copy Master Firmware** — Specifies that a software image file should be copied.
- **Destination** — The destination unit(s) (within the stack) to which the file is copied. Select from the menu one of the following values:
 - **All** — All units in the stack.
 - **Unit** — Specified unit within the stack, unit 1 for example.
- **Copy Configuration** — Specifies that a configuration file should be copied.
- **Source** — The configuration source file from which the file is copied. Select from the menu one of the following possible values:
 - **Running Config** — Uploads the running configuration file.
 - **Startup Config** — Uploads the startup configuration file.
 - **Backup Config** — Uploads the backup configuration file.
- **Destination** — The destination configuration file to which the file is copied. Select from the menu one of the following:
 - **Startup Config** — The startup configuration file.
 - **Backup Config** — The backup configuration file.
- **Restore Configuration Factory Default** — Select the radio button and click **Apply Changes** to restore all configuration structures to the defaults.

Copy Files Using CLI Commands

For information about the CLI command that perform this function, see the Configuration and Image Files Commands chapter in the *CLI Reference Guide*. The following table summarizes the equivalent CLI command you use to copy files from one location to another.

Table 6-51. Copy Command

CLI Command	Description
copy	Copies files from a source to a destination.

Defining Advanced Settings

Use Advanced Settings to set miscellaneous global attributes of the device. The changes to these attributes are applied only after the device is reset. Click **System** → **Advanced Settings** in the tree view to display the **Advanced Settings** page.

The **Advanced Settings** page contains a link for configuring Auto Configuration.

Auto Configuration

The Auto Configuration feature enables the configuration of a switch automatically when the device is turned on and, during the boot process, no configuration file is found in device storage. By communicating with a DHCP server, obtains an IP address for the switch and an IP address for a TFTP server. Auto Configuration attempts to download a configuration file from the TFTP server and install it on the switch.

The DHCP server that the switch communicates with must provide the following information:

- The IP address and subnet mask (option 1) to be assigned to the switch.
- The IP address of a default gateway (option 3), if needed for IP communication.
- The identification of the TFTP server from which to obtain the boot file. This is given by any of the following fields, in the priority shown (highest to lowest):
 - The sname field of the DHCP reply.
 - The hostname of the TFTP server (option 66). Either the TFTP address or name is specified—not both—in most network configurations. If a TFTP hostname is given, a DNS server is required to translate the name to an IP address.
 - The IP address of the TFTP server (option 150).
 - The address of the TFTP server supplied in the siaddr field.
 - The name of the configuration file (boot file or option 67) to be downloaded from the TFTP server. The boot file name must have a file type of *.cfg.

- The IP addresses of DNS name servers (option 6). The IP addresses of DNS name servers should be returned from the DHCP server only if the DNS server is in the same LAN as the switch performing Auto Configuration. A DNS server is needed to resolve the IP address of the TFTP server if only the “sname” or option 66 values are returned to the switch.

After obtaining IP addresses for both the switch and the TFTP server, the Auto Configuration feature attempts to download a host-specific configuration file using the boot file name specified by the DHCP server. If the switch fails to obtain the file, it will retry indefinitely.

Use the **Auto Configuration** page to enable the switch to be automatically configured when it is initialized and cannot find a configuration file. With Auto Configuration enabled, the switch obtains an IP address and downloads a configuration file from a TFTP server.

 **NOTE:** The Auto Configuration process requires the DHCP client on the switch to be enabled by default. The Auto Configuration feature also depends upon the configuration of other devices in the network, including a DHCP or BOOTP server, a TFTP server and, if necessary, a DNS server.

To display the **Auto Configuration** page, click **System** → **Advanced Settings** → **Auto Configuration** in the tree view.

Figure 6-110. Auto Configuration

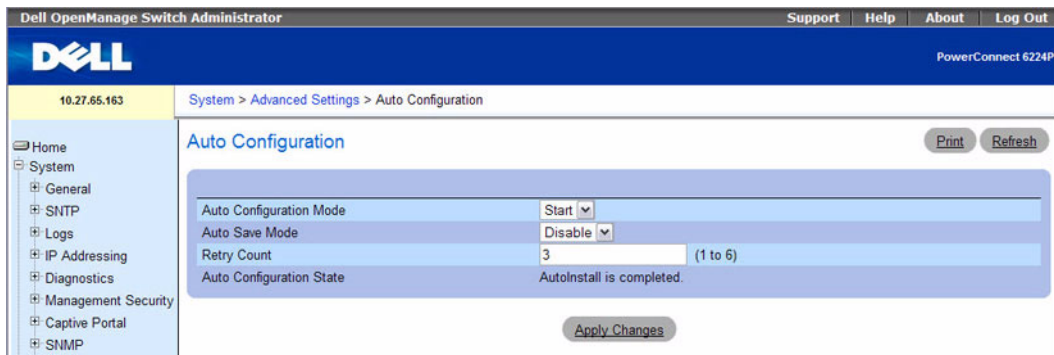

The **Auto Configuration** page contains the following fields:

- **Auto Configuration Mode** — Enables (Start) or disables (Stop) the Auto Configuration feature on the switch. Select Start to initiate sending a request to a DHCP server to obtain an IP address of a server and the configuration file name. If it obtains the server address, Auto Configuration proceeds to search for and download a configuration file from the server. If successful, it applies the configuration file to the switch. After starting the Auto Configuration process, you can monitor the status of the process by the messages in the Auto Configuration State and Retry Count fields.
- **Auto Save Mode** — Specifies whether to save the automatically downloaded configuration file to the startup configuration.
 - **Enable** — Automatically saves the configuration file to the startup configuration.

- **Disable** — Uses the configuration file as the running configuration only. When the switch reboots, it will load the configuration from the startup configuration file.
- **Retry Count** — Indicates the number of times to attempt the auto configuration process during boot up. The number of times the switch has attempted to contact the TFTP server during the current Auto Configuration session.
- **Auto Configuration State** — Shows the current state of the Auto Configuration process.

Configuring Auto Configuration Using CLI Commands

For information about the CLI commands that perform this function, see the Utility Commands - Auto Config chapter in the *CLI Reference Guide*. The following table summarizes the equivalent CLI commands you use to configure Auto Configuring.

Table 6-52. Auto Configuration Commands

CLI Command	Description
boot host auto-save	Enables/disables automatically saving the downloaded configuration on the switch.
boot host dhcp	Enables/disables Auto Config on the switch.
boot host retry-count	Set the number of attempts to download a configuration.
show boot	Displays the current status of the Auto Config process.

Defining Stacking

Overview

A stack is created by daisy-chaining stacking links on adjacent units. A stack of units is manageable as a single entity when the units are connected together. If a unit cannot detect a stacking partner on a port enabled for stacking, the unit automatically operates as a standalone unit. If a stacking partner is detected, the switch always operates in stacking mode. One unit in the stack is designated as the Master unit. The Master manages all the units in the stack. A second switch is designated as the Standby unit, which becomes the Master if the Master unit is unavailable. The Standby unit can either be user-configurable or automatically selected by the software.



NOTE: The terms "Master" and "Manager/Management Unit" are used interchangeably in this section.

When units are in a stack, the following activities occur:

- All units are checked for software version consistency.
- The switch Control Plane is only active on the Master.
- The switch Data Plane is active on all units in the stack, including the Master.
- The Master and Standby switches keep the running configuration in synchronization while the stack operates.

Synchronizing the Running Configuration between the Master and Standby Units

The Master unit synchronizes its running configuration with the Standby unit every two minutes (120 seconds) when a standby unit is configured in the stack. This enables the Standby unit to take over the stack operation with minimal interruption if the Master unit becomes unavailable.

The running-config synchronization also occurs when the administrator saves the running configuration to the startup configuration on the Master unit and when the administrator designates a new switch as the Master either by using the Web interface or the movemanagement CLI command.

If a Master unit failure is detected in the stack, the following activities occur:

- The Standby unit initializes the control plane and enables all other stack units with the current running configuration.
- During failover all the ports are brought down and brought up to avoid possible loops and get new master software applications to a consistent state.
- A log entry and a trap are generated when the stack failover is detected.

The stack comes up with the default configuration in the following cases:

- When the stack is cold started (powered ON).
- When the administrator selects a new Master unit and that unit was not previously configured or automatically selected as the Standby unit.

Configuring Stacking

Use the Stacking menu to set the stacking characteristics of the device. The changes to these attributes are applied only after the device is reset. Click **System** → **Stacking** in the tree view to display the **Stacking** page. Use this page to go to the following features:

- Stacking Standby
- Unit Configuration
- Stack Summary
- Supported Switches
- Stack Port Summary
- Stack Port Counters
- Stack Port Diagnostics
- Nonstop Forwarding
- Checkpoint Statistics

Stacking Standby

You can now select a unit in the stack to be the Standby switch. The unit configured as the Standby switch becomes the stack manager if the current manager fails. To remove the selected unit as the Standby switch, click **Delete**.

Unit Configuration

Use the **Unit Configuration** page to define general device parameters.

To display the **Unit Configuration** page, click **System** → **Stacking** → **Unit Configuration** in the tree view.

Figure 6-111. Unit Configuration

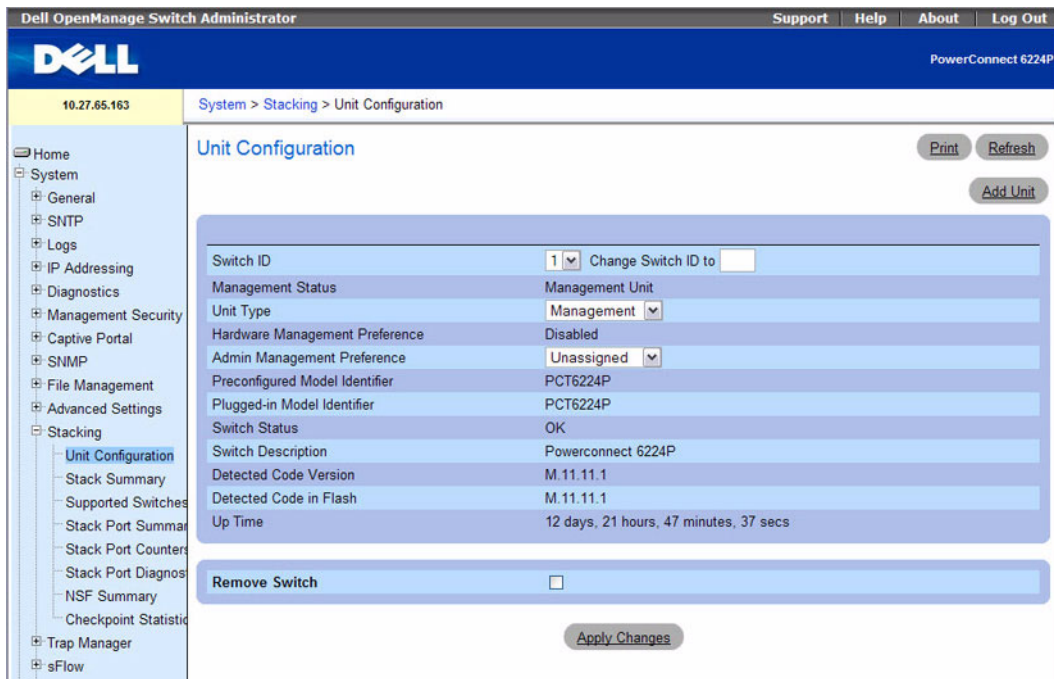

The Unit Configuration page contains the following fields:

- **Switch ID** — Specifies unit to be configured.
- **Change Switch ID to** — Changes the unit number of the selected unit.
- **Management Status** — Shows whether the selected unit is a Management Unit or a Stack Member.
- **Unit Type** — Specify whether the select unit is the Management Unit (Stack Master), a Stack Member, or the Standby Switch.
- **Hardware Management Preference** — Management preference by hardware configuration to be considered for selection as Management unit.
- **Admin Management Preference** — Determines whether this unit is capable of becoming the master switch. Values range from **Disable** (the unit cannot support Master Switch function) to **Preference 15**. The higher value means that the unit is more desirable than another unit with lower value for running the management function. An additional value is **Unassigned**, which means that preference is not configured, and election of the Master is left to the stack units.
- **Preconfigured Model Identifier** — A 16-byte character string to identify the pre-configured model of the selected unit.

- **Plugged-in Model Identifier** — A 16-byte character string to identify the plugged-in model of the selected unit.
- **Switch Status** — Displays the status of the selected unit. The possible values are:
 - **OK** — The unit is in place and functioning.
 - **Unsupported** — The unit is in place, but can not function as a member of the stack.
 - **Code Mismatch** — The software of the switch does not match the master unit software.
 - **Config Mismatch** — The configuration of the switch does not match the master unit configuration.
 - **Not Present** — The selected unit is not present.
- **Switch Description** — 80-byte data field used to identify the device.

Expected Code Type — Displays the expected code identifier.

- **Detected Code Version** — Running code version release number and version number.
- **Detected Code in Flash** — Release number and version number of the code detected in flash.
- **Up Time** — Displays how long the unit has been running since its last reset.
- **Remove Switch** — Select this option to remove switch from the stack.

Stack Summary

Use the **Stack Summary** page to view a summary of switches participating in the stack.

To display the **Stack Summary** page, click **System** → **Stacking** → **Stack Summary** in the tree view.

Figure 6-112. Stack Summary

Switch ID	Management Status	Standby Status	Preconfigured Model Identifier	Plugged-in Model Identifier	Switch Status	Firmware Version
1	Management Unit		PCT6224P	PCT6224P	OK	M.11.11.1

The **Stacking Summary** page contains the following fields:

- **Switch ID** — ID of the unit. The maximum number of units allowed in the stack is 12.
- **Management Status** — This field indicates whether the switch is currently operating as the management switch, the standby switch, or a stack member.

- **Standby Status** — This field identifies the switch that is configured as the Standby Unit. Possible values are:
 - OPR Standby — Indicates that this unit is operating as the Standby Unit and the configured Standby Unit is not part of the stack.
 - CFG Standby — Indicates that the unit is configured as the Standby Unit. The unit configured as the Standby switch becomes the stack manager if the current manager fails.
 - Blank — Indicates that the switch is not configured as the Standby Unit.
- **Unit Type**— This field indicates whether the switch is configured as the management switch, the standby switch, or a stack member.
- **Pre-configured Model Identifier** — This field displays the 16-character field assigned by the device manufacturer to identify the pre-configured device.
- **Plugged-in Model Identifier** — This field displays the 16-character field assigned by the device manufacturer to identify the plugged-in device.
- **Switch Status** — Indicates the unit status. There are five possible state values:
 - OK — The unit is in place and functioning properly.
 - Unsupported — The unit is not allowed to stack.
 - Code Mismatch — The software image in this unit does not match that being used in the master switch of the stack.
 - Config Mismatch — The configuration file in this unit does not match that being used in the master switch of the stack.
 - Not Present — The unit is not there.
- **Firmware Version** — Indicates the detected version of code on this unit.

Viewing Stack Summary Using CLI Commands

For information about the CLI commands that perform this function, see the System Management Commands chapter in the CLI Reference Guide. The following table summarizes the equivalent CLI commands you use to view Stack Summary information.

Table 6-53. Stack Summary Commands

CLI Command	Description
show switch	Displays information about all units in the stack.
switch priority	Configures the ability of the switch to become the Management Switch.
switch renumber	Changes the identifier for a switch in the stack.
member	Configures the switch as a member of a stack.
movemanagement	Moves the Management Switch functionality from one switch to another.
standby	Configures the standby in the stack.

Supported Switches

Use the **Supported Switches** page to view information regarding each type of supported switch for stacking, and information regarding the supported switches.

To display the **Supported Switches** page, click **System** → **Stacking** → **Supported Switches** in the tree view.

Figure 6-113. Supported Switches

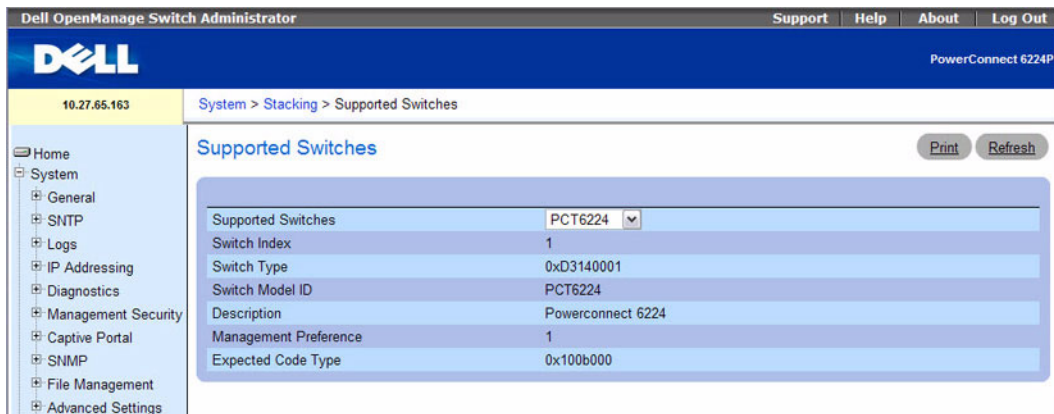

The **Supported Switches** page contains the following fields:

- **Supported Switches** — Drop-down list permits selection of switches supported.
- **Switch Index** — Specifies the index into the database of the supported switch types.
- **Switch Type** — Hardware ID given to the switch.
- **Switch Model ID** — Displays a 16-byte character string to identify the model of the supported switch.
- **Description** — Displays a 256-byte data field used to identify the device.

- **Management Preference** — Determines whether this unit is capable of becoming the master switch. If the value is set to zero then the unit cannot support Master Switch function. The higher value means that the unit is more desirable than another unit with lower value for running the management function. The device manufacturer sets the initial value of this field.
- **Expected Code Type** — Displays the release number and version number of the code expected.

Viewing Supported Switch Characteristics

1. Open the Supported Switches page.
2. Select desired switch from the Supported Switch drop-down list.

Viewing Supported Switches Using CLI Commands

For information about the CLI commands that perform this function, see the System Management Commands chapter in the CLI Reference Guide. The following table summarizes the equivalent CLI commands you use to view supported switches information.

Table 6-54. Viewing Supported Switches Commands

CLI Command	Description
show supported switchtype	Displays information about all supported switch types.

Stack Port Summary

Use the **Stack Port Summary** page to view the stackable ports present. This screen displays the unit, the stackable interface, the configured mode of the interface, the running mode as well as the link status and link speed of the stackable port.

To display the **Stack Port Summary** page, click **System** → **Stacking** → **Stack Port Summary** in the tree view.

Figure 6-114. Stack Port Summary

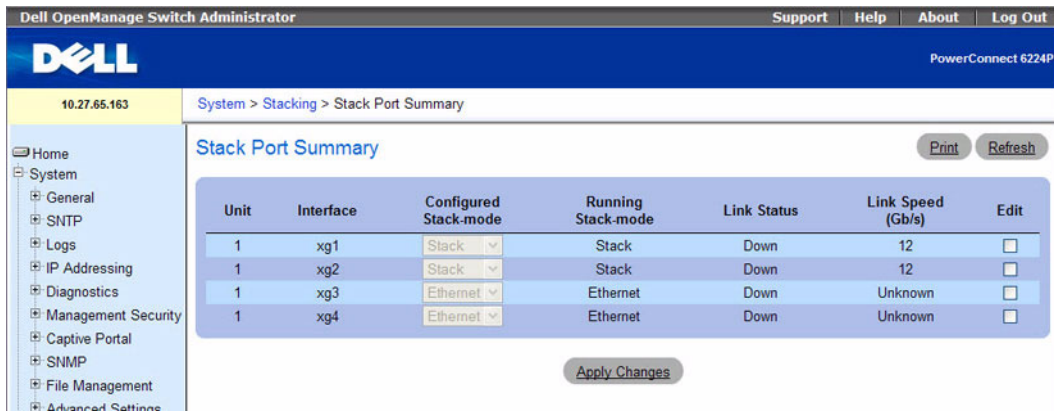

The Stack Port Summary page contains the following fields:

- **Unit** — ID number of the unit.
- **Interface** — Identifies the stack interface assigned to the unit.
- **Configured Stack Mode** — Indicates whether or not each unit is able to participate in the stack.
- **Running Stack Mode** — Indicates whether or not each unit is actually participating in the stack.
- **Link Status** — Indicates whether or not the stack interface for each unit is operating.
- **Link Speed (Gb/s)** — Indicates the nominal speed of each unit’s link.

Viewing Stack Port Summary Using CLI Commands

For information about the CLI commands that perform this function, see the System Management Commands chapter in the CLI Reference Guide. The following table summarizes the equivalent CLI commands you use to view Stack Port information.

Table 6-55. Stack Port Commands

CLI Command	Description
stack-port	Configures ports as either stack ports, or as Ethernet ports.
show stack-port	Displays summary stack-port information for all interfaces.

Stack Port Counters

Use the Stack Port Counters page to view the transmitted and received statistics, including data rate and error rate.

To display the Stack Port Counters page, click System →Stacking →Stack Point Counters in the tree view.

Figure 6-115. Stack Port Counters

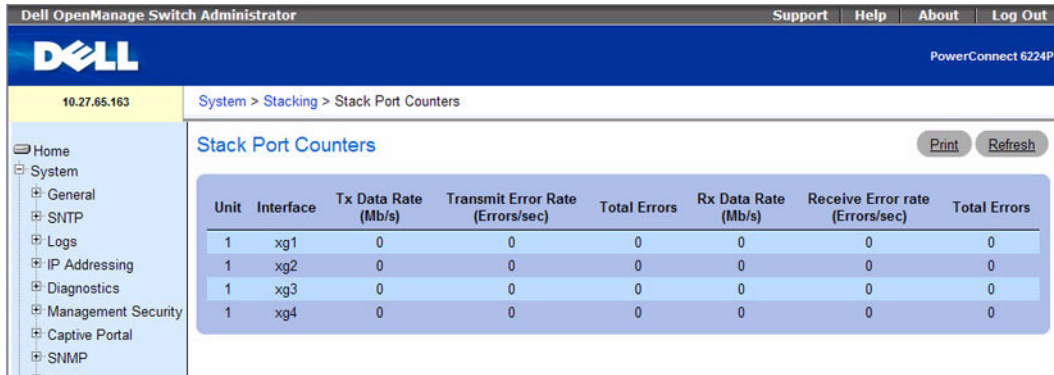

The Stack Port Counters page contains the following fields:

- **Unit** — Indicates the subordinate switch being viewed.
- **Interface** — Indicates the name of the interface.
- **Data Rate (Mb/s)** — Indicates the speed at which the data is transmitted.
- **Transmit Error Rate (Errors/sec)** — Indicates the number of errors transmitted per second.
- **Total Errors** — Total number of errors transmitted.
- **Data Rate (Mb/s)** — Indicates the speed at which the data is received.
- **Receive Error Rate (Errors/sec)** — Indicates the number of errors received per second.
- **Total Errors** — Total number of errors received.

Viewing Stack Port Counters

1. Open the Stack Port Counters page.

Viewing Stack Port Counters Using CLI Commands

For information about the CLI commands that perform this function, see the System Management Commands chapter in the CLI Reference Guide. The following table summarizes the equivalent CLI commands you use to view Stack Port Counters information.

Table 6-56. Stack Port Counters Command

CLI Command	Description
show stack-port counters	Displays summary data counter information for all interfaces.

Stack Port Diagnostics

The **Stack Port Diagnostics** page is intended for Field Application Engineers (FAEs) and developers only.

Nonstop Forwarding

Overview

When switches are members of a stack, packet forwarding rules, protocol configurations, and state information are controlled by a designated stack management unit. Typically, when the management unit fails due to a power failure, hardware failure, or software fault, neighbor routers detect that the management unit is down or restarting. Neighbor routers may recalculate route topology to avoid the restarting router, which can result in instability and degrade performance in the network.

The Nonstop Forwarding (NSF) feature enables stacked switches to continue to forward packets along known routes during a management unit restart. A designated backup management unit assumes control.

When NSF is enabled, the management and backup units perform data “checkpointing”, whereby the management unit communicates routing information for neighbors and clients to the backup unit. This enables the backup unit to assume control of forwarding policy on the stack using the same protocols and data that the management unit used. The OSPFv2 and OSPFv3 protocols can be enabled to participate in the checkpointing service so that current routing information is available to the backup unit (see "Nonstop Forwarding OSPF Graceful Restart" on page 551 and "Nonstop Forwarding OSPFv3 Graceful Restart" on page 671).

Enabling and Disabling NSF

You can use the NSF Summary page to enable nonstop forwarding feature on the stack, view operational status information, and to initiate a warm restart of the management unit.

When nonstop forwarding is enabled, if the management unit of a stack fails, the backup unit takes over as the master without clearing the hardware tables of any of the surviving units. Data traffic continues to be forwarded in hardware while the management functions initialize on the backup unit.

NSF is enabled by default on platforms that support it. The administrator may wish to disable NSF in order to redirect the CPU resources consumed by data checkpointing.

To display this page, click **System** → **Stacking** → **NSF** → **NSF Summary** in the navigation menu.

Figure 6-116. NSF Summary

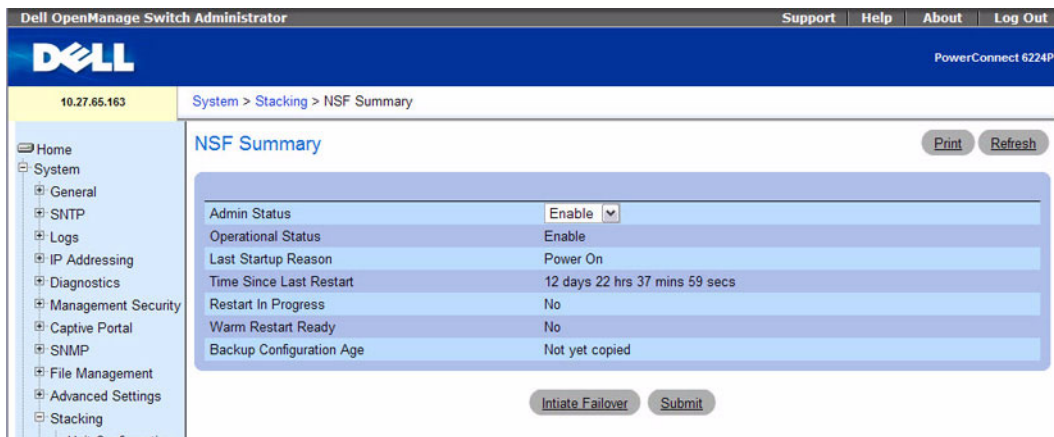

- Admin Status — Select the administrative mode for the interface. When enabled, the stack selects a backup unit to receive checkpointed data from applications on the management unit.
- Operation Status — Indicates whether NSF is operational on the stack, which may differ from the Admin Status setting. If a unit that does not support NSF is connected to the stack, then NSF is disabled on all stack members. When a unit that does not support NSF is disconnected from the stack and all other units support NSF, and NSF is administratively enabled, then NSF operation resumes.
- Last Startup Reason — The type of activation that caused the software to start the last time. The possible values are:
 - Power-On — The switch re-booted. This could have been caused by a power cycle or an administrative "Reload" command.
 - Administrative Move — The administrator issued a command for the stand-by manager to take over.
 - Warm-Auto-Restart — The primary management card restarted due to a failure, and the system executed a nonstop forwarding failover.
 - Cold-Auto-Restart — The system switched from the active manager to the backup manager and was unable to maintain user data traffic. This is usually caused by multiple failures occurring close together.
- Time Since Last Restart — Time since the current management card became the active management card. For the backup management unit, the value is set to 0d 00:00:00.
- Restart In Progress — Indicates whether a restart is in progress. A restart is not considered complete until all hardware tables have been fully reconciled.
- Warm Restart Ready — Indicates whether the initial full checkpoint has finished.

- **Backup Configuration Age** — Indicates the time since the running configuration was last copied to the backup unit.

Click **Initiate Failover** to start a warm restart. On a warm restart, the backup unit becomes the management unit without clearing its hardware tables (on a cold restart, hardware tables are cleared). Applications apply checkpointed data from the former management unit to the backup unit as the original management unit reboots.

If the system is not ready for a warm restart, for example because no backup unit has been elected or one or more members of the stack do not support nonstop forwarding, the command fails with a warning message.

Click **Submit** if you have updated the NSF Admin Status. If you want the switch to retain the new setting across a power cycle, you must perform a save.

Click **Refresh** to redisplay the page with the latest status values from the switch.

Configure Nonstop Forwarding Using CLI Commands

For information about the CLI commands that perform this function, see the System Management Commands chapter in the *CLI Reference Guide*. The following table summarizes the equivalent CLI commands you use to configure NSF.

Table 6-57. Nonstop Forwarding Commands

CLI Command	Description
[no] nsf	Enables or disables NSF on the stack.
show nsf	Displays global and per-unit information on NSF configuration on the stack.
initiate failover	Forces the backup unit to take over as the management unit and performs a “warm restart” of the stack.

Checkpoint Statistics

Use the Checkpoint Statistics page to display information about the protocol and routing data that the management unit shares with the backup unit. To display this page, click **System** → **Stacking** → **NSF** → **Checkpoint Statistics**.

Figure 6-117. Checkpoint Statistics

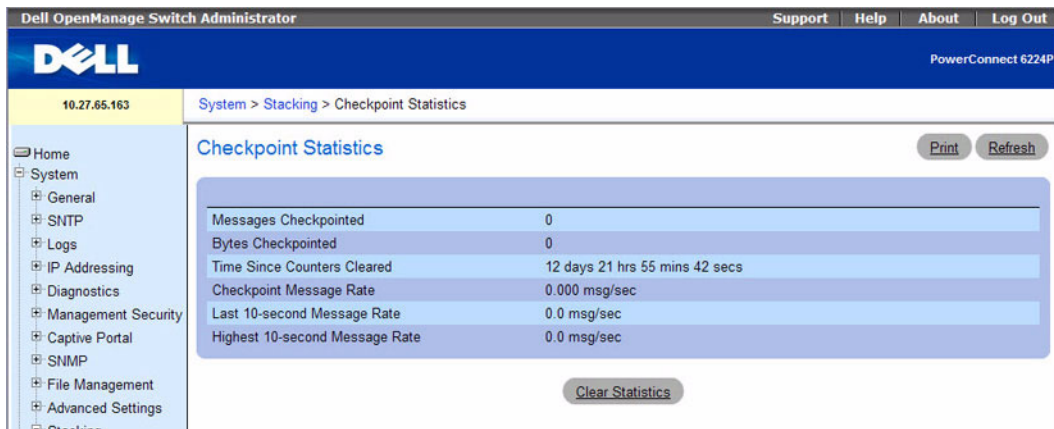

- Messages Checkpointed — The number of messages sent from master unit to backup unit.
- Bytes Checkpointed — How much data has been sent from master unit to the backup unit.
- Time Since Counters Cleared — The amount of time since the counters have been reset.
- Message Rate Interval — The number of seconds between measurements.
- Message Rate — The number of messages sent in the last measurement interval.
- Highest Message Rate — The highest number of messages that have been sent in a measurement interval.

Click **Clear Statistics** to reset all statistics to their default values.

Viewing Checkpoint Statistics Using CLI Commands

For information about the CLI commands that perform this function, see the System Management Commands chapter in the *CLI Reference Guide*. The following table summarizes the equivalent CLI commands you use to view checkpoint statistics.

Table 6-58. Checkpoint Statistics Commands

CLI Command	Description
show checkpoint statistics	Displays general information about the checkpoint service operation.
clear checkpoint statistics	Clears all checkpoint statistics to their initial values.

Trap Manager

Use the **Trap Manager** menus to configure traps flags and view the trap log. Click **System** → **Trap Manager** in the tree view to display the **Trap Manager** page. Use this page to go to the following features:

- Trap Flags
- OSPFv2 Trap Flags
- OSPFv3 Trap Flags
- Trap Log

Trap Flags

The **Trap Flags** page is used to specify which traps you want to enable or disable. When the condition identified by an active trap is encountered by the switch, a trap message is sent to any enabled SNMP Trap Receivers, and a message is written to the trap log.

To access the **Trap Flags** page, click **System** → **Trap Manager** → **Trap Flags** in the navigation tree.

Figure 6-118. Trap Flags

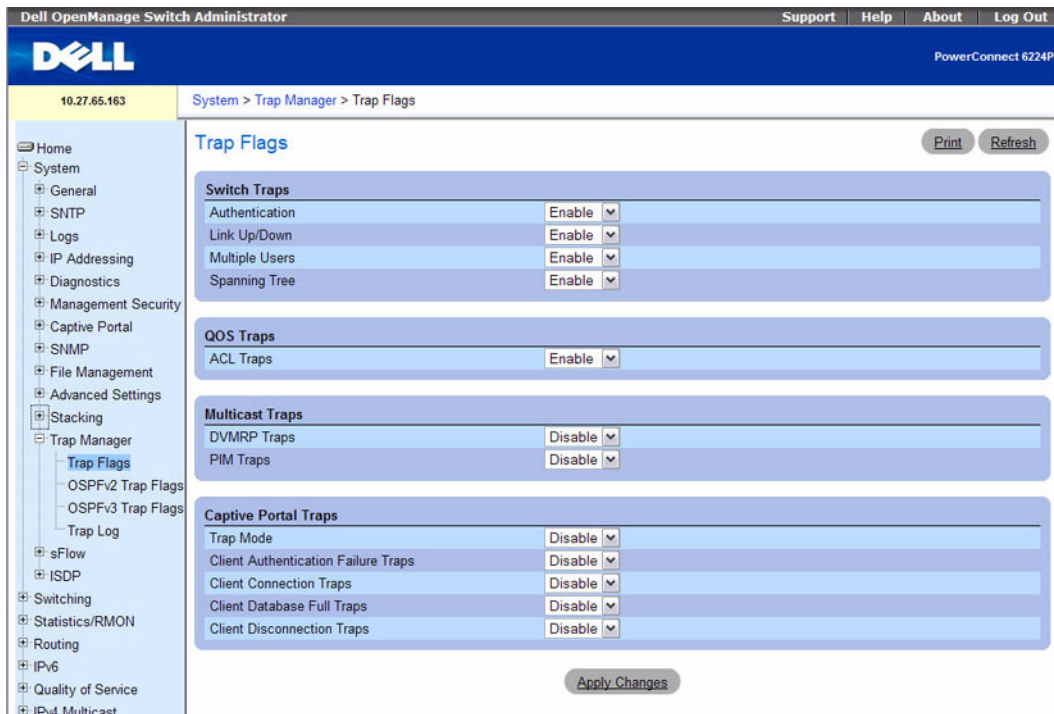

The **Trap Flags** page contains the following fields:

- **Switch Traps**
 - **Authentication** — Enable or disable activation of authentication failure traps by selecting the corresponding line on the pull-down entry field. The factory default is enabled.
 - **Link Up/Down** — Enable or disable activation of link status traps by selecting the corresponding line on the pull-down entry field. The factory default is enabled.
 - **Multiple Users** — Enable or disable activation of multiple user traps by selecting the corresponding line on the pull-down entry field. The factory default is enabled. This trap is triggered when the same user ID is logged into the switch more than once at the same time (either via telnet or the serial port).
 - **Spanning Tree** — Enable or disable activation of spanning tree traps by selecting the corresponding line on the pull-down entry field. The factory default is enabled.
- **QOS Traps**
 - **ACL Traps** — Enable or disable activation of ACL traps by selecting the corresponding line on the pull-down entry field. The factory default is enabled.
- **Multicast Traps**
 - **DVMRP Traps** — Enable or disable activation of DVMRP traps by selecting the corresponding line on the pull-down entry field. The factory default is disabled.
 - **PIM Traps** — Enable or disable activation of PIM traps by selecting the corresponding line on the pull-down entry field. The factory default is disabled.
- **Captive Portal Traps**
 - **Captive Portal Trap Mode** — Displays the captive portal trap mode status. Enable or disable by selecting the corresponding line on the pull-down entry field. The factory default is disabled.
 - **Client Authentication Failure Traps** — When enabled, the SNMP agent sends a trap when a client unsuccessfully attempts to authenticate with a captive portal.
 - **Client Connection Traps** — When enabled, the SNMP agent sends a trap when a client authenticates with and connects to a captive portal.
 - **Client Database Full Traps** — When enabled, the SNMP agent sends a trap each time an entry cannot be added to the client database because it is full.
 - **Client Disconnection Traps** — When enabled, the SNMP agent sends a trap when a client disconnects from a captive portal.

Configure Trap Flags Using CLI Commands

For information about the CLI commands that perform this function, see the SNMP Commands chapter in the *CLI Reference Guide*. The following table summarizes the equivalent CLI commands you use to configure trap flags.

Table 6-59. Trap Flag Commands

CLI Command	Description
snmp-server enable traps	Enables SNMP traps globally or enables specific SNMP traps.
show trapflags	Shows the status of the configurable SNMP traps.
show trapflags captive-portal	Shows the status of captive portal trapflags.

OSPFv2 Trap Flags

The **OSPFv2 Trap Flags** page is used to specify which OSPFv2 traps you want to enable or disable. When the condition identified by an active trap is encountered by the switch, a trap message is sent to any enabled SNMP Trap Receivers, and a message is written to the trap log.

To access the **OSPFv2 Trap Flags** page, click **System** → **Trap Manager** → **OSPFv2 Trap Flags** in the navigation tree.

Figure 6-119. OSPFv2 Trap Flags

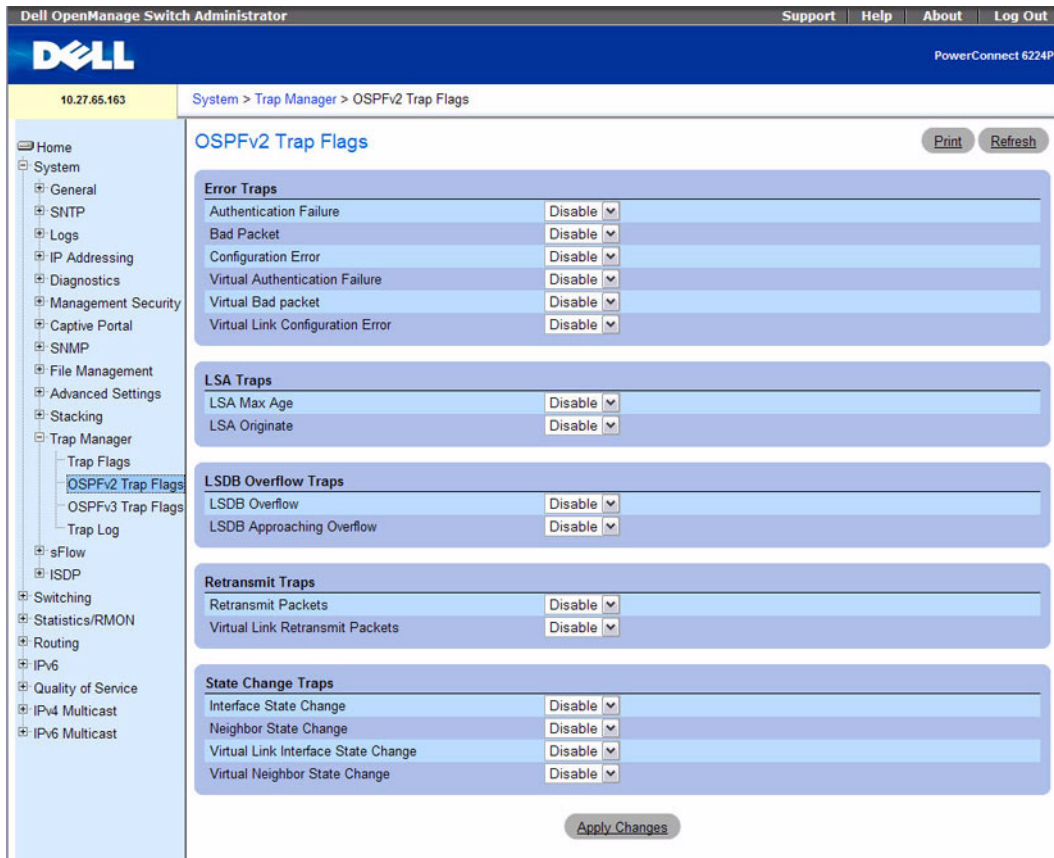

The OSPFv2 Trap Flags page contains the following fields:

- **Error Traps**
 - **Authentication Failure** — Signifies that a packet has been received on a non-virtual interface from a router with an authentication key or authentication type that conflicts with this router's authentication key or authentication type. The factory default is disabled.
 - **Bad Packet** — Signifies that an OSPF packet has been received on a non-virtual interface that cannot be parsed. The factory default is disabled.
 - **Configuration Error** — Signifies that a packet has been received on a non-virtual interface from a router with configuration parameters that conflict with this router's configuration parameters. The factory default is disabled.

- **Virtual Authentication Failure** — Signifies that a packet has been received on a virtual interface from a router with an authentication key or authentication type that conflicts with this router's authentication key or authentication type. The factory default is disabled.
- **Virtual Bad packet** — Signifies that an OSPF packet has been received on a virtual interface that cannot be parsed. The factory default is disabled.
- **Virtual Link Configuration Error** — Signifies that a packet has been received on a virtual interface from a router with configuration parameters that conflict with this router's configuration parameters. The factory default is disabled.
- **LSA Traps**
 - **LSA Max Age** — Signifies that one of the LSA in the router link-state database has aged to MaxAge. The factory default is disabled.
 - **LSA Originate** — Signifies that a new LSA has been originated by this router. This trap should not be invoked for simple refreshes of LSAs (every 30 minutes), but only when an LSA is (re)originated due to a topology change. This trap does not include LSAs that are being flushed because they have reached MaxAge. The factory default is disabled.
- **LSDB Overflow Traps**
 - **LSDB Overflow** — Signifies that the number of LSAs in the router link-state database has exceeded OSPF External LSDB Limit. The factory default is disabled.
 - **LSDB Approaching Overflow** — Signifies that the number of LSAs in the router link-state database has exceeded ninety percent of OSPF External LSDB Limit. The factory default is disabled.
- **Retransmit Traps**
 - **Retransmit Packets** — Signifies that an OSPF packet has been retransmitted on a non- virtual interface. All packets that may be retransmitted are associated with an LSDB entry. The LS type, LS ID, and Router ID are used to identify the LSDB entry. The factory default is disabled.
 - **Virtual Link Retransmit Packets** — Signifies that an OSPF packet has been retransmitted on a virtual interface. All packets that may be retransmitted are associated with an LSDB entry. The LS type, LS ID, and Router ID are used to identify the LSDB entry. The factory default is disabled.
- **State Change Traps**
 - **Interface State Change** — Signifies that there has been a change in the state of a non-virtual OSPF interface. This trap should be generated when the interface state regresses (e.g., goes from Dr to Down) or progresses to a terminal state (i.e., Point-to-Point, DR Other, Dr, or Backup). The factory default is disabled.
 - **Neighbor State Change** — Signifies that there has been a change in the state of a non-virtual OSPF neighbor. This trap should be generated when the neighbor state regresses (e.g., goes from Attempt or Full to 1-Way or Down) or progresses to a terminal state (e.g., 2-Way or Full). When a neighbor transitions from or to Full on non-broadcast multi-access and broadcast networks, the trap should be generated by the designated router. A designated router transitioning to Down will be noted by OSPF Interface State Change. The factory default is disabled.

- **Virtual Link Interface State Change** — Signifies that there has been a change in the state of an OSPF virtual interface. This trap should be generated when the interface state regresses (e.g., goes from Point-to-Point to Down) or progresses to a terminal state (i.e., Point-to-Point). The factory default is disabled.
- **Virtual Neighbor State Change** — Signifies that there has been a change in the state of an OSPF virtual neighbor. This trap should be generated when the neighbor state regresses (e.g., goes from Attempt or Full to 1-Way or Down) or progresses to a terminal state (e.g., Full). The factory default is disabled.

Configuring OSPFv2 Traps Using CLI Commands

For information about the CLI command that performs this function, see the SNMP Commands chapter in the *CLI Reference Guide*. The following table shows the equivalent CLI command you use to configure OSPFv2 traps.

Table 6-60. OSPFv2 Trap Command

CLI Command	Description
snmp-server enable traps ospf	Enables OSPF traps.

OSPFv3 Trap Flags

The **OSPFv3 Trap Flags** page is used to specify which OSPFv3 traps you want to enable or disable. When the condition identified by an active trap is encountered by the switch, a trap message is sent to any enabled SNMP Trap Receivers, and a message is written to the trap log.

To access the **OSPFv3 Trap Flags** page, click **System** → **Trap Manager** → **OSPFv3 Trap Flags** in the navigation tree.

Figure 6-120. OSPFv3 Trap Flags

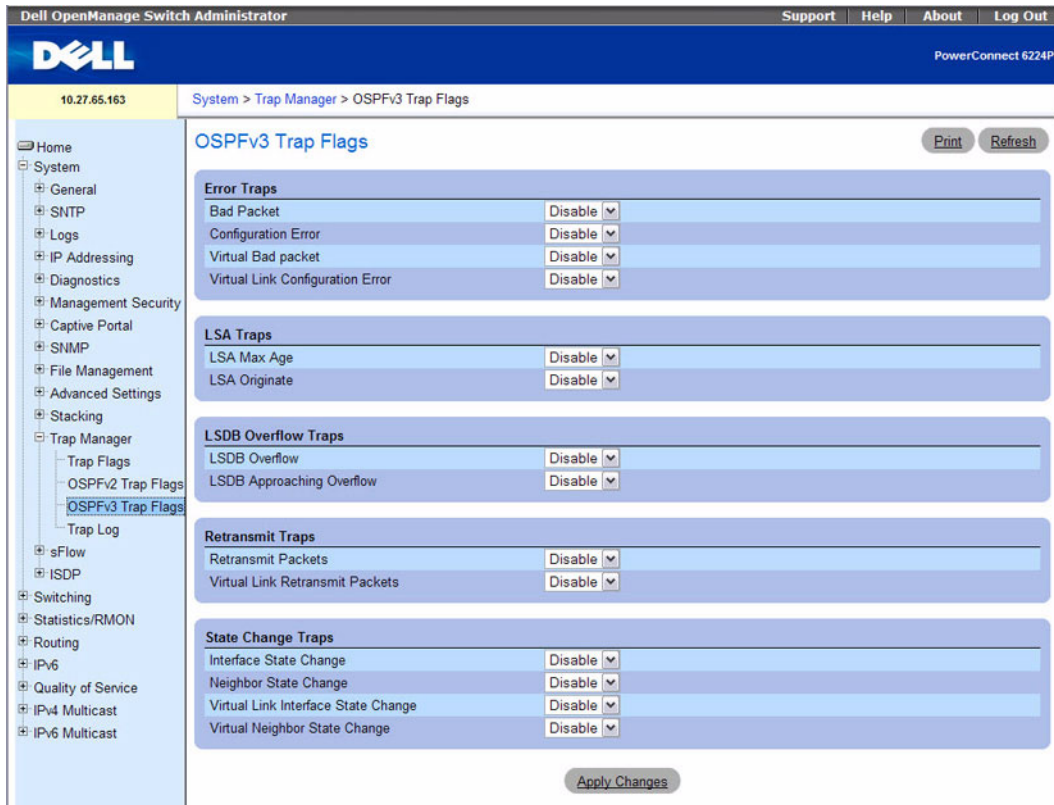

The OSPFv3 Trap Flags page contains the following fields:

- **Error Traps**
 - **Bad Packet** — Signifies that an OSPF packet has been received on a non-virtual interface that cannot be parsed. The factory default is disabled.
 - **Configuration Error** — Signifies that a packet has been received on a non-virtual interface from a router with configuration parameters that conflict with this router's configuration parameters. The factory default is disabled.
 - **Virtual Bad packet** — Signifies that an OSPF packet has been received on a virtual interface that cannot be parsed. The factory default is disabled.
 - **Virtual Link Configuration Error** — Signifies that a packet has been received on a virtual interface from a router with configuration parameters that conflict with this router's configuration parameters. The factory default is disabled.
- **LSA Traps**

- **LSA Max Age** — Signifies that one of the LSA in the router link-state database has aged to MaxAge. The factory default is disabled.
- **LSA Originate** — Signifies that a new LSA has been originated by this router. This trap should not be invoked for simple refreshes of LSAs (every 30 minutes), but only when an LSA is (re)originated due to a topology change. This trap does not include LSAs that are being flushed because they have reached MaxAge. The factory default is disabled.
- **LSDB Overflow Traps**
 - **LSDB Overflow** — Signifies that the number of LSAs in the router link-state database has exceeded OSPF External LSDB Limit. The factory default is disabled.
 - **LSDB Approaching Overflow** — Signifies that the number of LSAs in the router link-state database has exceeded ninety percent of OSPF External LSDB Limit. The factory default is disabled.
- **Retransmit Traps**
 - **Retransmit Packets** — Signifies that an OSPF packet has been retransmitted on a non- virtual interface. All packets that may be retransmitted are associated with an LSDB entry. The LS type, LS ID, and Router ID are used to identify the LSDB entry. The factory default is disabled.
 - **Virtual Link Retransmit Packets** — Signifies that an OSPF packet has been retransmitted on a virtual interface. All packets that may be retransmitted are associated with an LSDB entry. The LS type, LS ID, and Router ID are used to identify the LSDB entry. The factory default is disabled.
- **State Change Traps**
 - **Interface State Change** — Signifies that there has been a change in the state of a non-virtual OSPF interface. This trap should be generated when the interface state regresses (e.g., goes from Dr to Down) or progresses to a terminal state (i.e., Point-to-Point, DR Other, Dr, or Backup). The factory default is disabled.
 - **Neighbor State Change** — Signifies that there has been a change in the state of a non-virtual OSPF neighbor. This trap should be generated when the neighbor state regresses (e.g., goes from Attempt or Full to 1-Way or Down) or progresses to a terminal state (e.g., 2-Way or Full). When a neighbor transitions from or to Full on non-broadcast multi-access and broadcast networks, the trap should be generated by the designated router. A designated router transitioning to Down will be noted by OSPF Interface State Change. The factory default is disabled.
 - **Virtual Link Interface State Change** — Signifies that there has been a change in the state of an OSPF virtual interface. This trap should be generated when the interface state regresses (e.g., goes from Point- to-Point to Down) or progresses to a terminal state (i.e., Point-to-Point). The factory default is disabled.
 - **Virtual Neighbor State Change** — Signifies that there has been a change in the state of an OSPF virtual neighbor. This trap should be generated when the neighbor state regresses (e.g., goes from Attempt or Full to 1-Way or Down) or progresses to a terminal state (e.g., Full). The factory default is disabled.

Configuring OSPFv3 Traps Using CLI Commands

For information about the CLI command that performs this function, see the SNMP Commands chapter in the *CLI Reference Guide*. The following table shows the equivalent CLI command you use to configure OSPFv3 traps.

Table 6-61. OSPFv3 Trap Command

CLI Command	Description
snmp-server enable traps ospfv3	Enables OSPFv3 traps.

Trap Log

The **Trap Log** page is used to view entries that have been written to the trap log.

To access the **Trap Log** page, click **System** → **Trap Manager** → **Trap Log** in the navigation tree.

Figure 6-121. Trap Logs

The screenshot shows the Dell OpenManage Switch Administrator interface. The breadcrumb navigation is System > Trap Manager > Trap Log. The page title is "Trap Log". There are "Print" and "Refresh" buttons. Summary statistics are shown in a table:

Number of Traps Since Last Reset	67
Trap Log Capacity	256
Number of Traps Since Log Last Viewed	67

Below the summary is a table of trap log entries:

Log	System Up Time	Trap
0	0 days 01:16:36	Unit 1 has finished the copy operation successfully
1	0 days 00:01:34	1/0/5 status is authorized
2	0 days 00:01:34	1/0/5 status is Unauthorized
3	0 days 00:01:34	Link Up: 1/0/5
4	0 days 00:01:34	Entity Database: Configuration Changed
5	0 days 00:01:34	Link Up: 1/0/23
6	0 days 00:01:34	1/0/23 status is authorized
7	0 days 00:01:34	1/0/23 status is authorized
8	0 days 00:01:34	Power On Start has completed on unit 1.
9	0 days 00:01:34	1/0/28 status is Unauthorized
10	0 days 00:01:34	1/0/27 status is Unauthorized
11	0 days 00:01:34	1/0/26 status is Unauthorized
12	0 days 00:01:34	1/0/25 status is Unauthorized
13	0 days 00:01:34	1/0/24 status is Unauthorized
14	0 days 00:01:34	1/0/23 status is Unauthorized

The **Trap Log** page contains the following fields:

- **Number of Traps Since Last Reset** — The number of traps generated since the trap log entries were last cleared.

- **Trap Log Capacity** — The maximum number of traps stored in the log. If the number of traps exceeds the capacity, the entries will overwrite the oldest entries.
- **Number of Traps Since Log Last Viewed** — The number of traps that have occurred since the traps were last displayed. Displaying the traps by any method (terminal interface display, Web display etc.) will cause this counter to be cleared to 0.
- **Log** — The sequence number of this trap.
- **System Up Time** — The time at which this trap occurred, expressed in days, hours, minutes and seconds since the last reboot of the switch.
- **Trap** — Information associated with the trap.

View the Trap Log Using CLI Commands

For information about the CLI commands that perform this function, see the Syslog Commands chapter in the *CLI Reference Guide*. The following table shows the equivalent CLI command you use to show trap logs.

Table 6-62. Trap Log Commands

CLI Command	Description
show logging	Displays the state of logging and the syslog messages stored in the internal buffer.

sFlow

sFlow[®] is the standard for monitoring high-speed switched and routed networks. sFlow technology is built into network equipment and gives complete visibility into network activity, enabling effective management and control of network resources.

The sFlow monitoring system consists of an sFlow Agent (embedded in a switch or router or in a standalone probe) and a central sFlow Collector. The sFlow Agent uses sampling technology to capture traffic statistics from the device it is monitoring. sFlow datagrams are used to immediately forward the sampled traffic statistics to an sFlow Collector for analysis.

The sFlow Agent uses two forms of sampling: statistical packet-based sampling of switched or routed Packet Flows, and time-based sampling of counters.

Advantages of using sFlow include the following:

- It is possible to monitor all ports of the switch continuously with no impact on the distributed switching performance.
- Very little memory/CPU is required. Samples are not aggregated into a flow-table on the switch; they are forwarded immediately over the network to the sFlow collector.
- The system is tolerant to packet loss in the network (statistical model means loss is equivalent to slight change in sampling rate).

- The sFlow collector can receive data from multiple switches, providing a real-time synchronized view of the whole network.
- The collector can analyze traffic patterns for whatever protocols are found in the headers (e.g. TCP/IP, IPX, Ethernet, AppleTalk...), which means there is no need for a layer 2 switch to decode and understand all protocols.

sFlow Agent Summary

Packet Flow Sampling and Counter Sampling are performed by sFlow Instances associated with individual data sources within the sFlow Agent. Packet Flow Sampling and Counter Sampling are designed as part of an integrated system. Both types of samples are combined in sFlow datagrams. Packet Flow Sampling will cause a steady, but random, stream of sFlow datagrams to be sent to the sFlow Collector. Counter samples may be taken opportunistically in order to fill these datagrams.

In order to perform Packet Flow Sampling, an sFlow Sampler Instance is configured with a Sampling Rate. The Packet Flow sampling process results in the generation of Packet Flow Records. In order to perform Counter Sampling, the sFlow Poller Instance is configured with a Polling Interval. The Counter Sampling process results in the generation of Counter Records. The sFlow Agent collects Counter Records and Packet Flow Records and sends them in the form of sFlow datagrams to sFlow Collectors.

To access the sFlow Agent Summary page, click **System** → **sFlow** → **Agent Summary** in the navigation tree.

Figure 6-122. sFlow Agent Summary

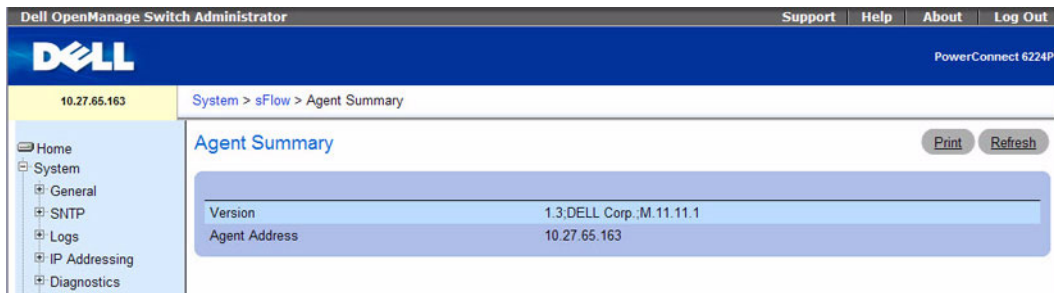

The sFlow Agent Summary page contains the following fields:

- **Version** — Uniquely identifies the version and implementation of this MIB. The version string must have the following structure: MIB Version; Organization; Software Revision where:
 - MIB Version — 1.3, the version of this MIB.
 - Organization — Dell Corp.
 - Revision — 1.0
- **Agent Address** — The IP address associated with this agent.

Configuring and Viewing sFlow Settings Using CLI Commands

For information about the CLI commands that perform this function, see the Flow Commands chapter in the *CLI Reference Guide*. The following table summarizes the equivalent CLI commands you use to configure and view sFlow settings.

Table 6-63. sFlow Settings Commands

CLI Command	Description
show sflow agent	Displays the sflow agent information.

sFlow Receiver Configuration

Use the sFlow Receiver Configuration page to configure the sFlow Receiver.

To access the sFlow Receiver Configuration page, click System → sFlow → Receiver Configuration in the navigation tree.

Figure 6-123. sFlow Receiver Configuration

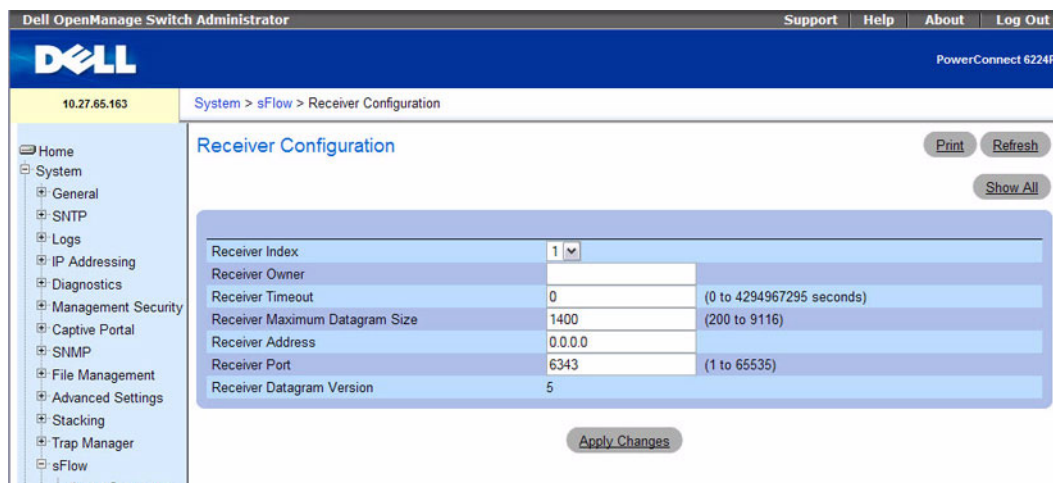

The sFlow Receiver Configuration page contains the following fields:

- **Receiver Index** — Selects the receiver for which data is to be displayed or configured. The allowed range is 1 to 8.

- **Receiver Owner String** — The entity making use of this sFlowRcvrTable entry. The empty string indicates that the entry is currently unclaimed and the receiver configuration is reset to the default values. An entity wishing to claim an sFlowRcvrTable entry must ensure that the entry is unclaimed before trying to claim it. The entry is claimed by setting the owner string. The entry must be claimed before any changes can be made to other sampler objects.
- **Receiver Timeout** — The time (in seconds) remaining before the sampler is released and stops sampling. A management entity wanting to maintain control of the sampler is responsible for setting a new value before the old one expires. The allowed range is 0 to 4294967295 seconds. A value of zero sets the selected receiver configuration to its default values.
- **Receiver Maximum Datagram Size** — The maximum number of data bytes that can be sent in a single sample datagram. The manager should set this value to avoid fragmentation of the sFlow datagrams. The default value is 1400. The allowed range is 200 to 9116.)
- **Receiver Address** — The IP address of the sFlow collector. If set to 0.0.0.0 no sFlow datagrams will be sent.
- **Receiver Port** — The destination port for sFlow datagrams. The allowed range is 1 to 65535).
- **Receiver Datagram Version** — The version of sFlow datagrams that should be sent.

Displaying the sFlow Receiver Summary Table

1. Open the sFlow Receiver Configuration page.
2. Click Show All.

The sFlow Receiver Summary page displays:

Figure 6-124. sFlow Receiver Summary

The screenshot shows a web interface titled "sFlow Receiver Summary" with "Print" and "Refresh" buttons. Below the title is a table with 7 columns: Receiver Index, Receiver Owner, Timeout, Maximum Datagram Size, Address, Port, and Datagram Version. The table contains 8 rows of data, all with identical values: Receiver Index 1-8, Receiver Owner (empty), Timeout 0, Maximum Datagram Size 1400, Address 0.0.0.0, Port 6343, and Datagram Version 5. A "Back" button is located below the table.

Receiver Index	Receiver Owner	Timeout	Maximum Datagram Size	Address	Port	Datagram Version
1		0	1400	0.0.0.0	6343	5
2		0	1400	0.0.0.0	6343	5
3		0	1400	0.0.0.0	6343	5
4		0	1400	0.0.0.0	6343	5
5		0	1400	0.0.0.0	6343	5
6		0	1400	0.0.0.0	6343	5
7		0	1400	0.0.0.0	6343	5
8		0	1400	0.0.0.0	6343	5

Viewing sFlow Receiver Information Using CLI Commands

For information about the CLI commands that perform this function, see the sFlow Commands chapter in the *CLI Reference Guide*. The following table summarizes the equivalent CLI commands you use to configure and view sFlow settings.

Table 6-64. sFlow Receiver Commands

CLI Command	Description
sflow destination	Configures sFlow collector parameters (owner string, receiver timeout, ip address, and port).

sFlow Sampler Configuration

The sFlow Agent collects a statistical packet-based sampling of the switched flows and sends them to the configured receivers. A data source configured to collect flow samples is called a sampler.

Packet Flow Sampling

The Packet Flow Sampling mechanism carried out by each sFlow instance ensures that any packet observed at a Data Source has an equal chance of being sampled, irrespective of the Packet Flow(s) to which it belongs.

Packet Flow Sampling is accomplished as follows:

- When a packet arrives on an interface, the Network Device makes a filtering decision to determine whether the packet should be dropped.
- If the packet is not filtered (dropped), a destination interface is assigned by the switching/routing function.
- At this point, a decision is made on whether or not to sample the packet. The mechanism involves a counter that is decremented with each packet. When the counter reaches zero, a sample is taken. When a sample is taken, the counter that indicates how many packets to skip before taking the next sample is reset. The value of the counter is set to a random integer where the sequence of random integers used over time is the Sampling Rate.

To access the sFlow Sampler Configuration page, click **System** → **sFlow** → **Sampler Configuration** in the navigation tree.

Figure 6-125. sFlow Sampler Configuration

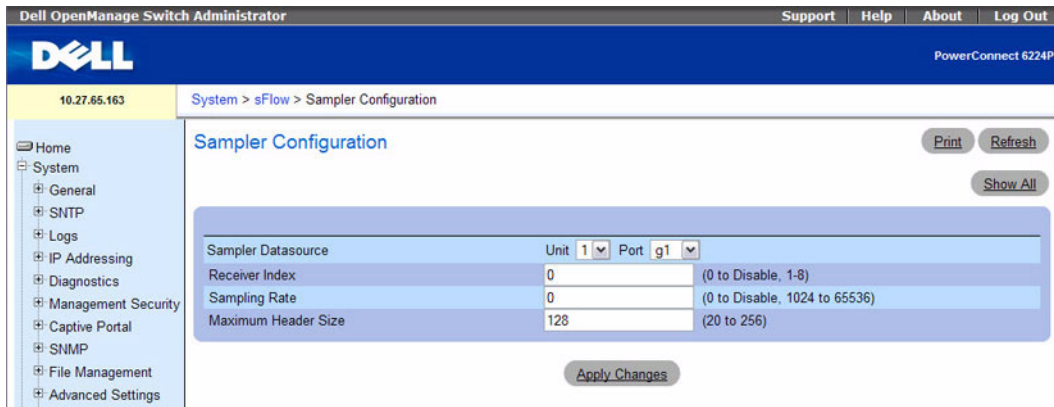

The sFlow Sampler Configuration page contains the following fields:

- **Sampler DataSource**— The sFlow data source for this sFlow sampler. This Agent supports physical ports only.
- **Receiver Index** — The sFlow Receiver for this sFlow sampler. If set to zero, no packets will be sampled. Only active receivers can be set. If a receiver expires, then all samplers associated with the receiver will also expire. The allowed range is 1 to 8.
- **Sampling Rate** — The statistical sampling rate for packet sampling from this source. A sampling rate of zero (0) disables sampling. The allowed range is 1024 to 65536.
- **Maximum Header Size** — The maximum number of bytes that should be copied from a sampled packet. The allowed range is 20 to 256.

Displaying the sFlow Sampler Summary Table

1. Open the sFlow Sampler Configuration page.
2. Click Show All.

The sFlow Sampler Summary page displays:

Figure 6-126. sFlow Sampler Summary

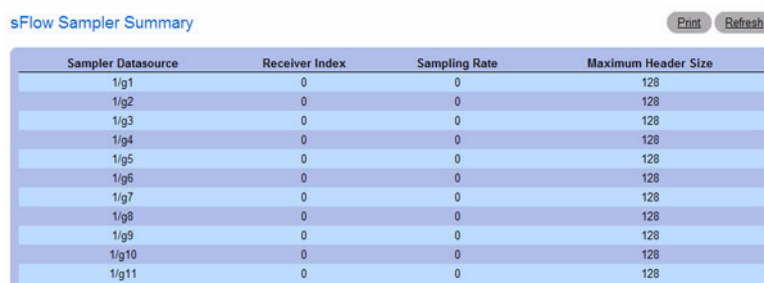

The screenshot shows a table titled "sFlow Sampler Summary" with two buttons "Print" and "Refresh" in the top right corner. The table has four columns: "Sampler Datasource", "Receiver Index", "Sampling Rate", and "Maximum Header Size". It lists 11 data sources from 1/g1 to 1/g11, all with a Receiver Index of 0, a Sampling Rate of 0, and a Maximum Header Size of 128.

Sampler Datasource	Receiver Index	Sampling Rate	Maximum Header Size
1/g1	0	0	128
1/g2	0	0	128
1/g3	0	0	128
1/g4	0	0	128
1/g5	0	0	128
1/g6	0	0	128
1/g7	0	0	128
1/g8	0	0	128
1/g9	0	0	128
1/g10	0	0	128
1/g11	0	0	128

Configuring and Viewing sFlow Settings Using CLI Commands

For information about the CLI commands that perform this function, see the sFlow Commands chapter in the *CLI Reference Guide*. The following table summarizes the equivalent CLI commands you use to configure and view sFlow settings.

Table 6-65. sFlow Settings Commands

CLI Command	Description
sflow sampling	Enables a new sflow sampler instance for this data source if rcvr_idx is valid.
show sflow sampling	Displays the sFlow sampling instances created on the switch.
show sflow polling	Displays the sFlow polling instances created on the switch.

sFlow Poll Configuration

The sFlow agent collects time-based sampling of network interface statistics and sends them to the configured sFlow receivers. A data source configured to collect counter samples is called a poller.

Counter Sampling

The primary objective of Counter Sampling is to efficiently, periodically export counters associated with Data Sources. A maximum Sampling Interval is assigned to each sFlow instance associated with a Data Source.

Counter Sampling is accomplished as follows:

The sFlow Agent keeps a list of counter sources being sampled. When a Packet Flow Sample is generated, the sFlow Agent examines the list and adds counters to the sample datagram, least recently sampled first. Counters are only added to the datagram if the sources are within a short period, i.e. five seconds, of failing to meet the required Sampling Interval. Periodically, i.e. every second, the sFlow Agent examines the list of counter sources and sends any counters that need to be sent to meet the sampling interval requirement.

To access the sFlow Poll Configuration page, click System → sFlow → Poll Configuration in the navigation tree.

Figure 6-127. sFlow Poll Configuration

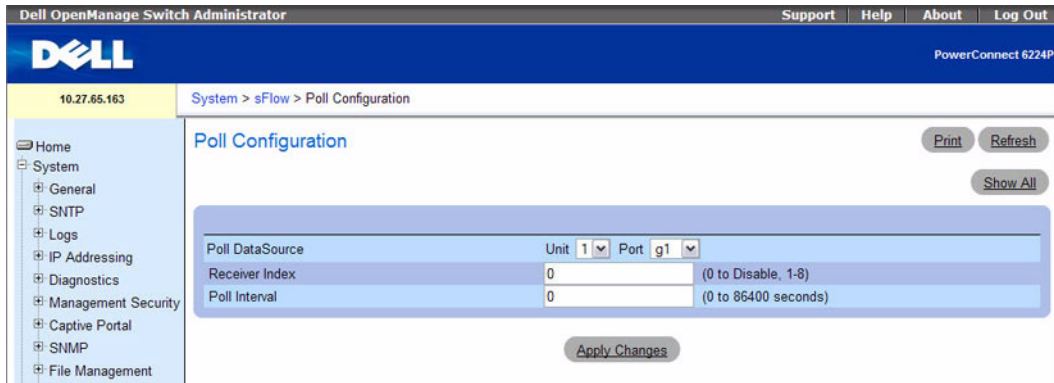

The sFlow Poll Configuration page contains the following fields:

- **Poll DataSource** — The sFlow Sampler data source for this flow sampler. This Agent supports physical ports only.
- **Receiver Index** — The sFlowReceiver for this sFlow Counter Poller. If set to zero, the poller configuration is set to the default and the poller is deleted. Only active receivers can be set. If a receiver expires, then all pollers associated with the receiver will also expire. The allowed range is 1 to 8.
- **Poll Interval** — The maximum number of seconds between successive samples of the counters associated with this data source. The range is 0 to 86400 seconds.

Displaying the sFlow Poller Summary Table

1. Open the sFlow Poll Configuration page.
2. Click Show All.

The sFlow Poll Summary page displays:

Figure 6-128. sFlow Poll Summary

Poll DataSource	Receiver Index	Poll Interval
1/g1	0	0
1/g2	0	0
1/g3	0	0

Configuring and Viewing sFlow Settings Using CLI Commands

For information about the CLI commands that perform this function, see the sFlow Commands chapter in the *CLI Reference Guide*. The following table summarizes the equivalent CLI commands you use to configure and view sFlow settings.

Table 6-66. sFlow Poll Configuration Commands

CLI Command	Description
sflow polling	Enables a new sflow poller instance for the data source if rcvr_idx is valid.
sflow polling (Interface Mode)	Enable a new sflow poller instance for this data source if rcvr_idx is valid.

Industry Standard Discovery Protocol

The Industry Standard Discovery Protocol (ISDP) is a proprietary Layer 2 network protocol that inter-operates with Cisco→devices running the Cisco Discovery Protocol (CDP). ISDP is used to share information between neighboring devices. The switch software participates in the CDP protocol and is able to both discover and be discovered by other CDP-supporting devices.

The ISDP menu contains links to the following pages:

- ISDP Global Configuration
- Cache Table
- Interface Configuration
- ISDP Statistics

ISDP Global Configuration

From the **ISDP Global Configuration** page, you can configure the ISDP settings for the switch, such as the administrative mode.

To access the **ISDP Global Configuration** page, click **System →ISDP →Global Configuration** in the navigation tree.

Figure 6-129. ISDP Global Configuration

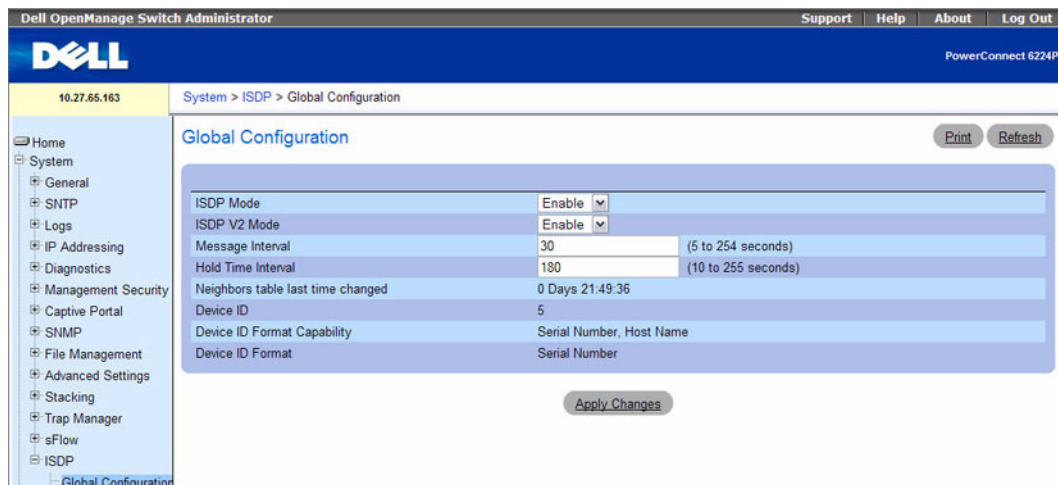

The ISDP Global Configuration page contain the following fields:

- **ISDP Mode** — Use this field to enable or disable the Industry Standard Discovery Protocol on the switch.
- **ISDP V2 Mode** — Use this field to enable or disable the Industry Standard Discovery Protocol v2 on the switch.
- **Message Interval** — Specifies the ISDP transmit interval. The range is (5–254). Default value is 30 seconds.
- **Hold Time Interval** — The receiving device holds ISDP message during this time period. The range is (10–255). Default value is 180 seconds.
- **Neighbors Table Last Time Changed** — Indicates when the Neighbors table entry was last modified.
- **Device ID** — The Device ID advertised by this device. The format of this Device ID is characterized by the value of Device ID Format object.
- **Device ID Format Capability** — Indicates the Device ID format capability of the device.
 - **serialNumber** — Indicates that the device uses serial number as the format for its Device ID.
 - **macAddress** — Indicates that the device uses layer 2 MAC address as the format for its Device ID.
 - **other** — Indicates that the device uses its platform specific format as the format for its Device ID.
- **Device ID Format** — Indicates the Device ID format of the device.
 - **serialNumber** — Indicates that the value is in the form of an ASCII string containing the device serial number.
 - **macAddress** — Indicates that the value is in the form of Layer 2 MAC address.

- **other** — Indicates that the value is in the form of a platform specific ASCII string containing info that identifies the device. For example: ASCII string contains serialNumber appended/prepended with system name.

Configuring ISDP Using CLI Commands

For information about the CLI commands that perform this function, see the CDP Interoperability Commands chapter in the *CLI Reference Guide*. The following table summarizes the equivalent CLI commands you use to configure ISDP.

Table 6-67. ISDP Commands

CLI Command	Description
isdp advertise-v2	Enables the sending of ISDP version 2 packets from the device.
isdp enable	Enables ISDP on the switch.
isdp holdtime	Configures the hold time for ISDP packets that the switch transmits.
isdp timer	Sets period of time between sending new ISDP packets.
show isdp	Displays global ISDP settings.

Cache Table

From the ISDP Cache Table page, you can view information about other devices the switch has discovered through the ISDP.

To access the ISDP Cache Table page, click **System** → **ISDP** → **Cache Table** in the navigation tree.

Figure 6-130. ISDP Cache Table

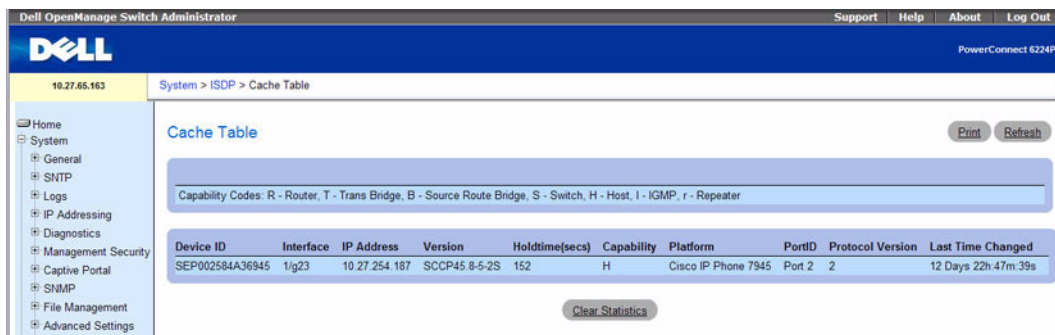

The ISDP Cache Table page contain the following fields:

- **Device ID** — Displays the string with Device ID which is reported in the most recent ISDP message.
- **Interface** — Displays the interface that this neighbor is attached to.

- **IP Address** — The (first) network-layer address that is reported in the Address TLV of the most recently received ISDP message.
- **Version** — Displays the Version string for the neighbor.
- **Holdtime** — Displays the ISDP holdtime for the neighbor.
- **Capability** — Displays the ISDP Functional Capabilities for the neighbor.
- **Platform** — Displays the ISDP Hardware Platform for the neighbor.
- **Port ID** — Displays the ISDP port ID string for the neighbor.
- **Protocol Version** — Displays the ISDP Protocol Version for the neighbor.
- **Last Time Changed** — Displays when entry was last modified.

Viewing ISDP Cache Table Information CLI Commands

For information about the CLI commands that perform this function, see the CDP Interoperability Commands chapter in the *CLI Reference Guide*. The following table summarizes the equivalent CLI commands you use to view and configure ISDP.

Table 6-68. ISDP Cache Commands

CLI Command	Description
clear isdp table	Clears entries in the ISDP table.
show isdp entry	Displays ISDP entries.
show isdp neighbors	Displays the list of neighboring devices.

Interface Configuration

From the **ISDP Interface Configuration** page, you can configure the ISDP settings for each interface.

If ISDP is enabled on an interface, it must also be enabled globally in order for the interface to transmit ISDP packets. If the ISDP mode on the ISDP Global Configuration page is disabled, the interface will not transmit ISDP packets, regardless of the mode configured on the interface.

To access the **ISDP Interface Configuration** page, click **System** → **ISDP** → **Interface Configuration** in the navigation tree.

Figure 6-131. ISDP Interface Configuration

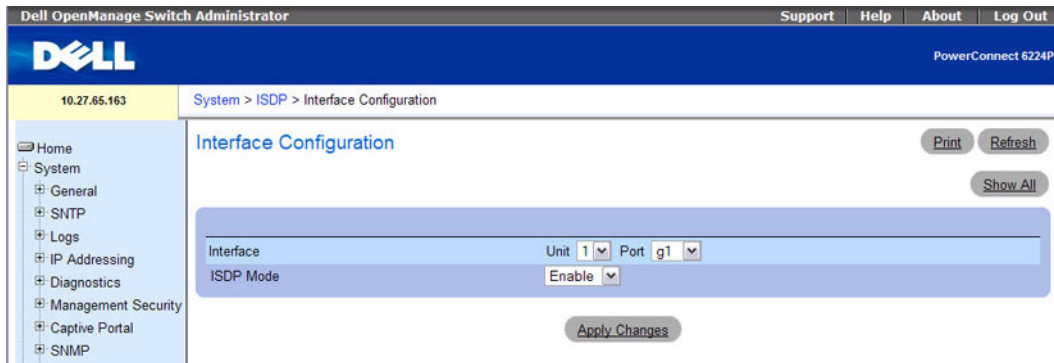

The ISDP Interface Configuration page contains the following fields:

- **Interface** — Select the interface with the ISDP mode status to configure or view.
- **ISDP Mode** — Use this field to enable or disable the Industry Standard Discovery Protocol on the selected interface.

Displaying the ISDP Interface Summary Table

1. Open the ISDP Interface Configuration page.
2. Click Show All.

The ISDP Interface Summary page displays:

Figure 6-132. ISDP Interface Summary

Interface	ISDP Mode
1/g1	Enable
1/g2	Enable
1/g3	Enable
1/g4	Enable
1/g5	Enable
1/g6	Enable
1/g7	Enable
1/g8	Enable
1/g9	Enable

Configuring and Viewing ISDP Interfaces Using CLI Commands

For information about the CLI commands that perform this function, see the CDP Interoperability Commands chapter in the *CLI Reference Guide*. The following table summarizes the equivalent CLI commands you use to configure ISDP.

Table 6-69. ISDP Interface Commands

CLI Command	Description
isdpr enable (Interface Mode)	Enables ISDP on an interface.
show isdpr interface	Displays ISDP settings for the specified interface.

ISDP Statistics

From the **ISDP Statistics** page, you can view information about the ISDP packets sent and received by the switch.

To access the **ISDP Statistics** page, click **System** → **ISDP** → **Statistics** in the navigation tree.

Figure 6-133. ISDP Statistics

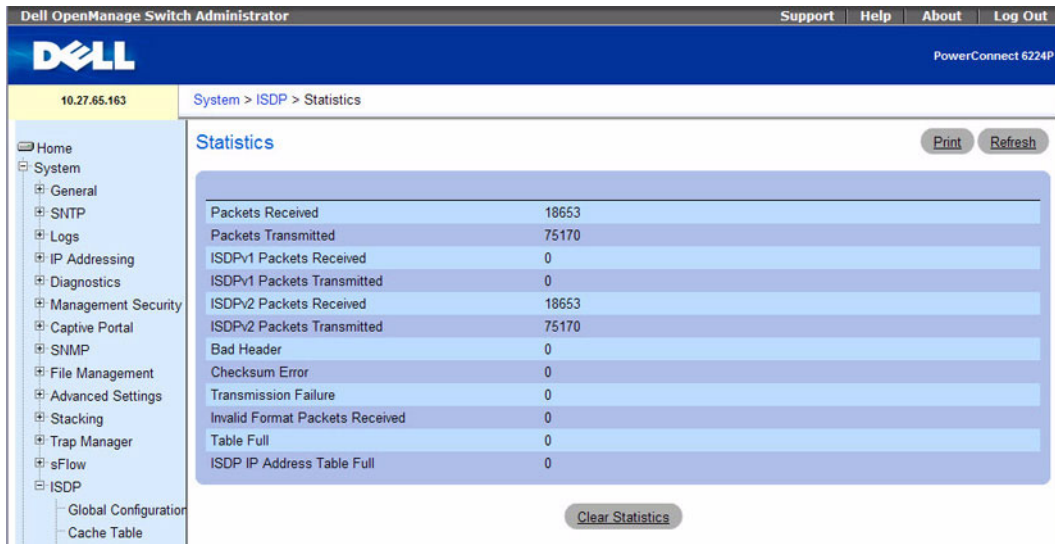

The ISDP Statistics page contain the following fields:

- **Packets Received** — Displays the number of all ISDP protocol data units (PDUs) received.
- **Packets Transmitted** — Displays the number of all ISDP PDUs transmitted.
- **ISDPv1 Packets Received** — Displays the number of v1 ISDP PDUs received.
- **ISDPv1 Packets Transmitted** — Displays the number of v1 ISDP PDUs transmitted.
- **ISDPv2 Packets Received** — Displays the number of v2 ISDP PDUs received.
- **ISDPv2 Packets Transmitted** — Displays the number of v2 ISDP PDUs transmitted.
- **Bad Header** — Displays the number of ISDP PDUs that were received with bad headers.
- **Checksum Error** — Displays the number of ISDP PDUs that were received with checksum errors.
- **Transmission Failure** — Displays the number of ISDP PDUs transmission failures.
- **Invalid Format Packets Received** — Displays the number of ISDP PDUs that were received with an invalid format.
- **Table Full** — Displays the number of times the system tried to add an entry to the ISDP table but was unsuccessful because the table was full.
- **ISDP IP Address Table Full** — Displays the number of times the system tried to add an entry to the ISDP IP Address table but was unsuccessful because the table was full.

Displaying ISDP Statistics Using CLI Commands

For information about the CLI commands that perform this function, see the CDP Interoperability Commands chapter in the *CLI Reference Guide*. The following table summarizes the equivalent CLI commands you use to view ISDP.

Table 6-70. ISDP Statistics Commands

CLI Command	Description
clear isdp counters	Clears the ISDP counters.
show isdp traffic	Displays ISDP statistics.

iSCSI Optimization

The Internet Small Computer System Interface (iSCSI) Optimization feature enables the switch to detect the presence of EqualLogic (EQL) storage arrays on the network and automatically configure the software to enhance the flow of storage traffic to the iSCSI device.

iSCSI optimization uses LLDP snooping to detect the presence and the removal of EQL arrays on the network. In LLDP advertisements, these devices are distinguished by a 29-byte System Description TLV that contains the value "Dell Equallogic Storage Array".

When the iSCSI optimization feature is enabled, the switch takes the following actions:

- Flow control is globally enabled (if it is not already enabled).
- Jumbo frames are globally enabled on all ports and port-channels (the MTU is globally set to 9216).

When an EQL device is identified, the software performs the following EQL-specific logic:

- Spanning Tree Port Fast mode is enabled on the interface identified by LLDP. In Port Fast mode, the port is automatically placed in the "Forwarding" state when the port link is up, without waiting for Spanning Tree convergence to complete.
- Unicast storm control is disabled on the interface identified by LLDP.
- RSTP is globally enabled.

By default, iSCSI Optimization is globally disabled and Flow Control is globally enabled.

iSCSI Optimization Global Configuration

Use the iSCSI Optimizations-Global Parameters page to enable and disable the feature.

To access the iSCSI Optimization Global Configuration page, click **System** → **iSCSI** → **Global Configuration** in the navigation tree.

Figure 6-134. iSCSI Sessions

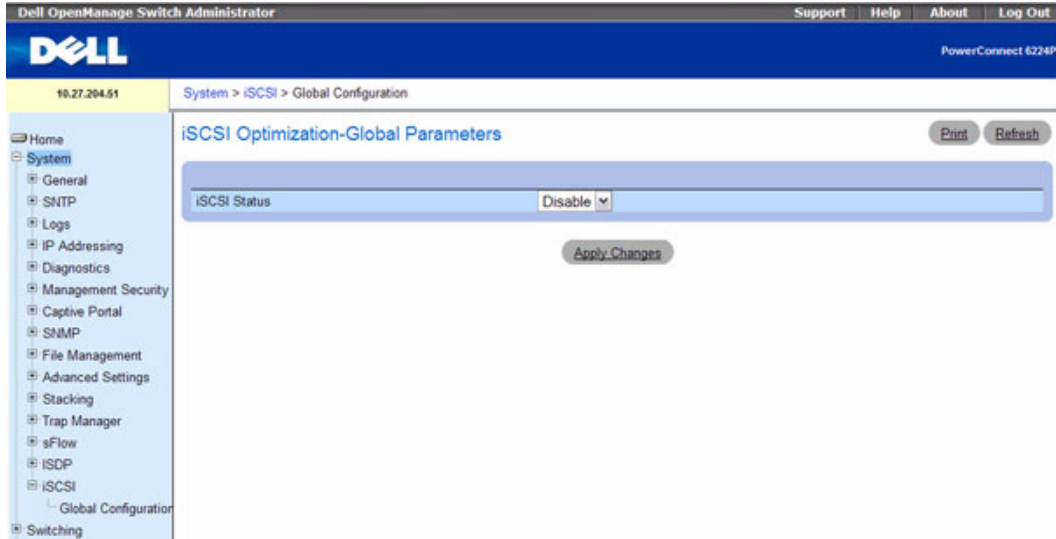

When you change the status to Enable, the following message displays:

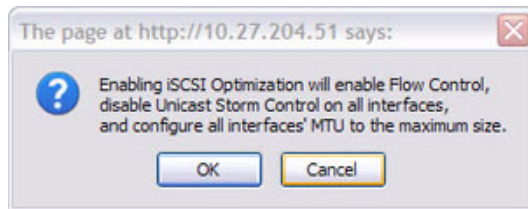

Configuring iSCSI Optimization Using CLI Commands

For information about the CLI commands that perform this function, see the iSCSI Commands chapter in the *CLI Reference Guide*:

The following table summarizes the equivalent CLI commands you use to configure iSCSI Optimization.

Table 6-71. iSCSI Optimization Commands

CLI Command	Description
iscsi enable	Globally enables iSCSI awareness.
show iscsi	Displays whether iSCSI is enabled or disabled.

Configuring Switching Information

Overview

This section provides all system operations and general information for network security, ports, address tables, GARP, VLANs, Spanning Tree, Port Aggregation, and Multicast Support. The topics covered in this section include:

- Configuring Network Security
- Configuring Ports
- Configuring Traffic Mirroring
- Configuring Address Tables
- Configuring GARP
- Configuring the Spanning Tree Protocol
- Configuring VLANs
- Configuring Voice VLAN
- Aggregating Ports
- Managing Multicast Support
- IGMP Snooping
- MRouter Status
- MLD Snooping
- Configuring the Link Layer Discovery Protocol (LLDP)
- Creating Link Dependencies
- Dynamic ARP Inspection
- DHCP Snooping
- DHCP Relay

Configuring Network Security

Use the **Network Security** menu page to set network security through port-based authentication, locked ports, DHCP Filtering configuration, and access control lists.

To display the **Network Security** page, click **Switching** → **Network Security** in the tree view.

The **Network Security** menu page contains links to the following features:

- **Dot1x Authentication**
- **Authenticated Users**
- **Port Security**
- **IP ACL Configuration**
- **MAC ACL Configuration**
- **IPv6 Access Control Lists**
- **ACL Bind Configuration**

Dot1x Authentication

IEEE 802.1X port-based network access control configuration is performed on the **Dot1x Authentication** page. MAC-based authentication allows multiple supplicants connected to the same port to each authenticate individually. For example, a system attached to the port might be required to authenticate in order to gain access to the network, while a VoIP phone might not need to authenticate in order to send voice traffic through the port.

The 802.1X network has three components:

- **Authenticators** — Specifies the port that is authenticated before permitting system access.
- **Supplicants** — Specifies host connected to the authenticated port requesting access to the system services.
- **Authentication Server** — Specifies the external server, for example, the RADIUS server that performs the authentication on behalf of the authenticator, and indicates whether the user is authorized to access system services.

Use the **Dot1x Authentication** page to configure the 802.1X administrative mode on the switch and to configure general 802.1X parameters for a port.

To display the **Dot1x Authentication** page, click **Switching** → **Network Security** → **Dot1x Authentication** in the tree view.

Figure 7-1. Dot1x Authentication

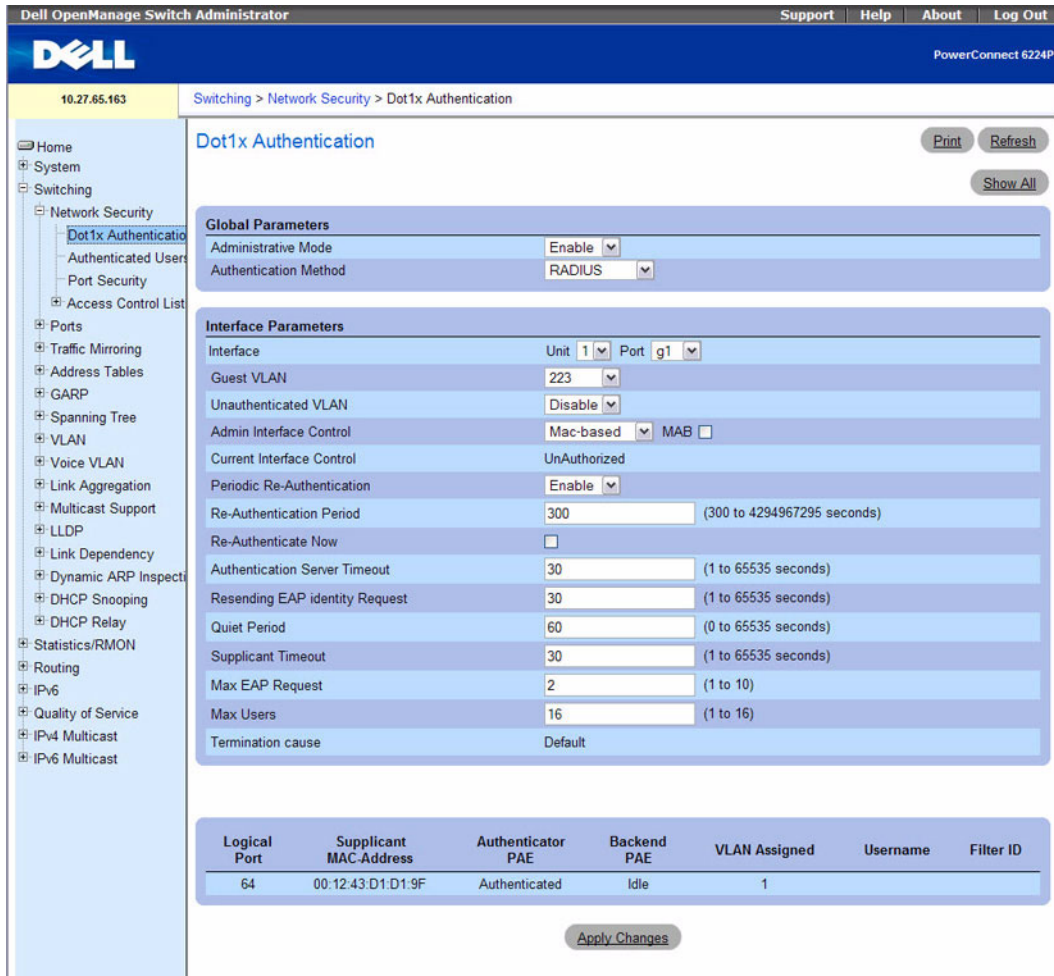

The Dot1x Authentication page contains the following fields:

Global Parameters

- **Administrative Mode**— Permits 802.1X port-based authentication on the switch. The possible field values are:
 - **Enable** — Enables 802.1X authentication on the switch.
 - **Disable** — Disables 802.1X authentication on the switch.
- **Authentication Method** — Selects the Authentication method used. The possible field values are:
 - **Unconfigured** — Indicates that an authentication method has not been selected.

- **None** — Indicates that no authentication method is used.
- **RADIUS** — Indicates that authentication occurs at the RADIUS server.

Interface Parameters

- **Interface** — Selects the Unit and Port to be affected.
- **Guest VLAN** — Enables or disables the guest VLAN mode on this interface. To enable the guest VLAN, select the VLAN ID to use as the guest VLAN. All VLANs configured on the system are included in the menu.
- **Unauthenticated VLAN** — Allows or prohibits unauthenticated traffic on the port. To allow unauthenticated traffic on the port, select the ID of the VLAN to assign to supplicants that fail 802.1X authentication.
- **Admin Interface Control** — Defines the port authorization state. The possible field values are:
 - **Automode** — Automatically detects the mode of the interface.
 - **Authorized** — Places the interface into an authorized state without being authenticated. The interface sends and receives normal traffic without client port-based authentication.
 - **Unauthorized** — Denies the selected interface system access by moving the interface into unauthorized state. The switch cannot provide authentication services to the client through the interface.
 - **MAC-based** — Allows multiple hosts to authenticate on the interface. The hosts are distinguished by their MAC addresses.
- **Current Interface Control** — Displays the current port authorization state.
- **Periodic Re-Authentication** — Reauthenticates the selected port periodically, when enabled.
- **Re-Authentication Period** — Indicates the time span in which the selected port is reauthenticated. The possible field range is 300–4294967295 seconds. The field default is 3600 seconds.
- **Re-Authenticate Now** — Forces immediate port reauthentication, when selected.
- **Authentication Server Timeout** — Defines the amount of time that lapses before the switch resends a request to the authentication server. The possible field range is 1–65535 seconds. The field default is 30 seconds.
- **Resending EAP Identity Request** — Defines the amount of time that lapses before EAP requests are resent. The possible field range is 1–65535 seconds. The field default is 30 seconds.
- **Quiet Period** — Defines the amount of time that the switch remains in the quiet state following a failed authentication exchange. The possible field range is 0–65535 seconds. The field default is 60 seconds.
- **Supplicant Timeout** — Defines the amount of time that lapses before EAP requests are resent to the user. The possible field range is 1–65535 seconds. The field default is 30 seconds.
- **Max EAP Requests** — Defines the maximum number of times the switch can send an EAP request before restarting the authentication process if it does not receive a response. The possible field range is 1–10. The field default is 2 retries.

- **Max Users** — Set the maximum number of clients supported on the port when MAC-based 802.1X authentication is enabled on the port. The number of users allowed to authenticate per port ranges from 1 to 16.
- **Termination Cause** — Displays the reason for termination.
- **MAC Authentication Bypass** — Enable this feature to provide 802.1x unaware clients controlled access to the network using the MAC address of the device as an identifier. The known and allowable MAC address and corresponding access rights must be configured in the authentication server. MAC Authentication Bypass only works when the port control mode of the port is MAC based.
- When supplicants connect to the port, information about that supplicant is displayed in a table below the configuration fields. The supplicant table contains the following information:
 - **Logical Port** — The port to which the supplicant is connected.
 - **Supplicant MAC Address** — The MAC-address of the supplicant
 - **Authenticator PAE** — Current state of the authenticator PAE state machine. Possible values are Initialize, Disconnected, Connecting, Authenticating, Authenticated, Aborting, Held, ForceAuthorized, and ForceUnauthorized.
 - **Backend PAE** — Current state of the backend authentication state machine. Possible values are Request, Response, Success, Fail, Timeout, Idle, and Initialize.
 - **VLAN Assigned** — The VLAN assigned to the client by the RADIUS server. When VLAN assignments are disabled, the RADIUS server does not assign any VLAN to the port, and this field is set to 0.
 - **VLAN Name** — This feature is an extension of the Dot1x Option 81 feature added in PowerConnect Release 2.1. A VLAN name is accepted as an alternative to a number when RADIUS indicates the Tunnel-Private-Group-ID for a supplicant. Because this option is a text string, it can also be used for a VLAN name. To support this feature, ensure that VLAN names are unique.
 - **Username** — The username representing the identity of the Supplicant. This field shows the username when the Admin Interface Control is Automode or MAC-based. If the port is Authorized, it shows the username of the current user. If the port is unauthorized it shows the last user that was authenticated successfully.
 - **Filter ID** — The Filter Id assigned to the client by the RADIUS server. This field is not applicable when the Filter-Id feature is disabled on the RADIUS server and client.

Displaying the Dot1x Authentication Table

1. Open the **Dot1x Authentication** page.
2. Click **Show All**.

The **Dot1x Authentication Table** page opens, displaying the left side of the table:

Figure 7-2. Dot1x Authentication Table

Ports	Admin Port Control	Current Port Control	Max Users	Periodic Re-Authentication	Re-Authenticate Now	Quiet Period	Resending EAP	Max EAP Requests	Supplicant Timeout	Server Timeout	Termination Cause	Edit
1 S/sg1	Authorized	Authorized	15	Enabled	3600	00	30	2	30	30		
2 S/sg2	Authorized	Authorized	15	Enabled	3600	00	30	2	30	30		
3 S/sg3	Authorized	Authorized	15	Enabled	3600	00	30	2	30	30		
4 S/sg4	Authorized	Authorized	15	Enabled	3600	00	30	2	30	30		
5 S/sg5	Authorized	NA	15	Enabled	3600	00	30	2	30	30		
6 S/sg6	Authorized	Authorized	15	Enabled	3600	00	30	2	30	30		
7 S/sg7	Authorized	Authorized	15	Enabled	3600	00	30	2	30	30		
8 S/sg8	Authorized	Authorized	15	Enabled	3600	00	30	2	30	30		
9 S/sg9	Authorized	Authorized	15	Enabled	3600	00	30	2	30	30		
10 S/sg10	Authorized	Authorized	15	Enabled	3600	00	30	2	30	30		
11 S/sg11	Authorized	Authorized	15	Enabled	3600	00	30	2	30	30		
12 S/sg12	Authorized	Authorized	15	Enabled	3600	00	30	2	30	30		

3. Use the horizontal scroll bar or click the right arrow at the bottom of the screen to display the right side of the table.
4. Use the **Unit** drop-down menu to view the **Dot1x Authentication Table** for other units in the stack, if they exist.

Re-Authenticating One Port

1. Open the **Dot1x Authentication** page.
2. Click **Show All**.
The **Dot1x Authentication Table** displays.
3. Check **Edit** to select the **Unit/Port** to re-authenticate.
4. Check **Reauthenticate Now**.
5. Click **Apply Changes**.
The specified port is re-authenticated, and the device is updated.

Re-Authenticating Multiple Ports in the Dot1x Authentication Table

1. Open the **Dot1x Authentication** page.
2. Click **Show All**.
The **Dot1x Authentication Table** displays.
3. Check **Edit** to select the **Units/Ports** to re-authenticate.
4. To re-authenticate on a periodic basis, set **Periodic Re-Authentication** to **Enable**, and specify a **Re-Authentication Period** for all desired ports.
5. To re-authenticate immediately, check **Reauthenticate Now** for all ports to be re-authenticated.
6. Click **Apply Changes**.
Specified ports are re-authenticated (either immediately or periodically), and the device is updated.

Changing Administrative Port Control

1. Open the **Dot1x Authentication** page.
2. Click **Show All**.

The **Dot1x Authentication Table** displays.

3. Scroll to the right side of the table and select the **Edit** check box for each port to configure. Change **Admin Port Control** to **Authorized**, **Unauthorized**, or **Automode** as needed for chosen ports. Only **MAC-Based** and **Automode** actually uses dot1x to authenticate. **Authorized** and **Unauthorized** are manual overrides.
4. Click **Apply Changes**.

Admin Port Control is updated for the specified ports, and the device is updated.

Enabling Dot1x Authentication Using CLI Commands

For information about the CLI commands that perform this function, see the following chapter in the *CLI Reference Guide*:

- 802.1X Commands

The following table summarizes the equivalent CLI commands you use to enable dot1x authentication.

Table 7-1. 802.1x Authentication Commands

CLI Command	Description
dot1x mac-auth-bypass	Enables MAB on an interface.
dot1x max-req	Sets the maximum number of times the switch sends an EAP-request frame to the client before restarting the authentication process.
dot1x max-users	Sets the maximum number of clients supported on the port when MAC-based 802.1X authentication is enabled on the port.
dot1x port-control	Enables manual control of the authorization state of the port.
dot1x re-authenticate	Manually initiates a re-authentication of all 802.1x-enabled ports or a specified 802.1X enabled port.
dot1x re-authentication	Enables periodic re-authentication of the client.
dot1x system-auth-control	Enables 802.1X globally.
dot1x timeout quiet-period	Sets the number of seconds the switch remains in the quiet state following a failed authentication attempt
dot1x timeout re-authperiod	Sets the number of seconds between re-authentication attempts.
dot1x timeout server-timeout	Sets the number of seconds the switch waits for a response from the authentication server before resending the request.
dot1x timeout supp-timeout	Sets the number of seconds the switch waits for a response to an EAP-request frame from the client before retransmitting the request.
dot1x timeout tx-period	Sets the number of seconds the switch waits for a response to an EAP-request/identify frame from the client before resending the request.
show dot1x	Displays 802.1X status for the switch or the specified interface.
show dot1x ethemet	Shows the status of MAC Authentication Bypass.
dot1x guest-vlan	Sets the guest VLAN on a port.
dot1x unauth-vlan	Specifies the unauthenticated VLAN on a port.

Authenticated Users

The **Authenticated Users** page is used to display lists of ports that have authenticated users.

To display the **Authenticated Users** page, click **Switching** → **Network Security** → **Authenticated Users** in the tree view.

Figure 7-3. Network Security Authenticated Users

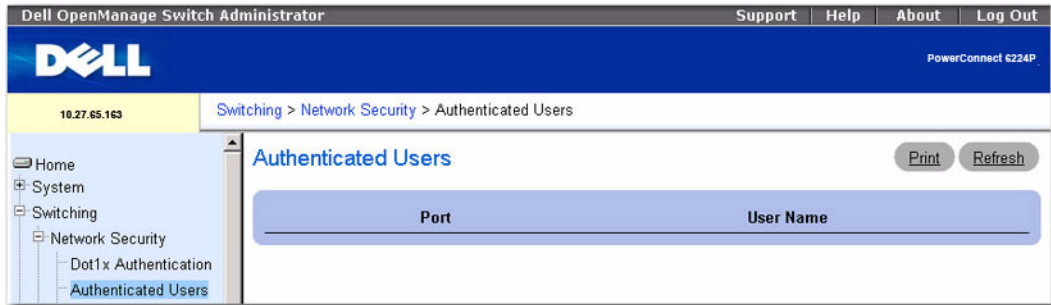

The **Authenticated Users** page contains the following fields:

- **Port** — Displays the port used for authentication.
- **User Name** — Specifies a user from the list of users authorized via the RADIUS Server.

Displaying Authenticated Users Using CLI Commands

For information about the CLI commands that perform this function, see the following chapter in the *CLI Reference Guide*:

- 802.1X Commands

Table 7-2. 802.1x Authenticated Users Commands

CLI Command	Description
show dot1x clients	Displays detailed information about the users who have successfully authenticated on the system or on a specified port.
show dot1x users	Displays active 802.1X authenticated users for the switch.

Port Security

The **Port Security** page is used to enable security on a per-port basis. When a port is locked, only packets with allowable source MAC addresses can be forwarded. All other packets are discarded. A MAC address can be defined as allowable by one of two methods: dynamically or statically.

To display the **Port Security** page, click **Switching** → **Network Security** → **Port Security** in the tree view.

Figure 7-4. Network Security Port Security

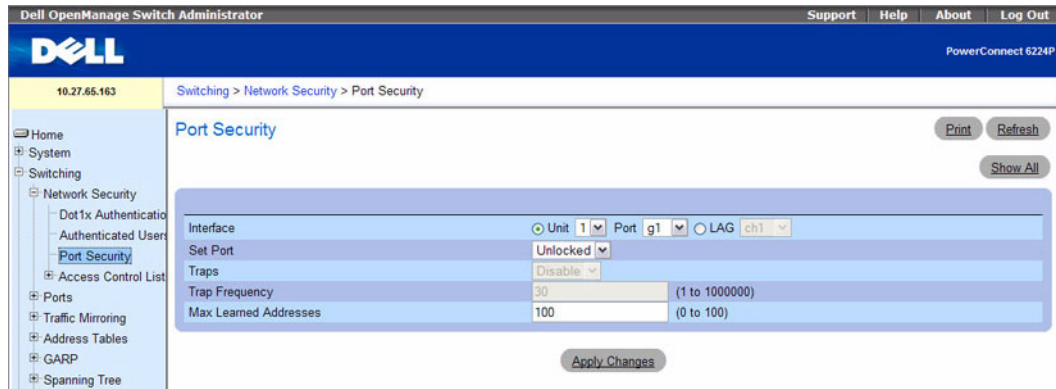

The **Port Security** page contains the following fields:

- **Interface** — Displays the unit and port or the LAG on which the locked port security is enabled.
- **Set Port** — Enables locking the port or LAG. When a port is locked, all the current addresses that had been dynamically learned by the switch on that port are removed from the list. When the port is unlocked, they are removed from the static list.
- **Traps** — Enables or disables sending a trap when a packet is received on a locked port or LAG.
- **Trap Frequency** — Specifies the time interval in seconds between successive traps. The valid range is 1 to 1000000 seconds.
- **Max Learned Addresses** — Specifies the Max Learned Addresses count. Valid range is 0 to 100.

Defining a Locked Port

1. Open the **Port Security** page.
2. Select an interface type and number.
3. Select **Locked** on the **Set Port** drop-down menu.
4. Complete the remaining fields.
5. Click **Apply Changes**.

The locked port/LAG is added to the Port Security table, and the device is updated.

Viewing the Port Security Table

1. Open the **Port Security** page.
2. Click **Show All**.

The **Port Security Table** displays.

Figure 7-5. Port Security Table

Ports	Current Port Control	Set Port	Set Post,Action	Trap	Trap Frequency	Edit
1 1/xg1	Link Up	Unlock ▼	Discard ▼	Disable ▼	30	<input checked="" type="checkbox"/>
2 1/xg2	Link Down	Unlock ▼	Discard ▼	Disable ▼	30	<input type="checkbox"/>
3 1/xg3	Link Up	Unlock ▼	Discard ▼	Disable ▼	30	<input type="checkbox"/>

3. Use the **Unit** drop-down menu to view the **Port Security Table** for other units in the stack, if they exist.

Defining Multiple Locked Ports

1. Open the **Port Security** page.
2. Click **Show All**.

The **Port Security Table** displays.

3. Click **Edit** for each port whose parameters are to be changed.
4. Fields can now be edited as needed for these ports.
5. Click **Apply Changes**.

The changes are made to the Port Security table, and the device is updated.

Configuring Port Security with CLI Commands

For information about the CLI commands that perform this function, see the following chapter in the *CLI Reference Guide*:

- Address Table Commands

The following table summarizes the equivalent CLI commands you use to configure port security.

Table 7-3. Port Security Commands

CLI Command	Description
port security (no port security)	Disables the learning of new addresses on an interface. To enable new address learning, use the no form of the port security command.
port security max	Configures the maximum addresses that can be learned on the port while the port is in port security mode.
show ports security	Displays the port-lock status.

IP ACL Configuration

Access control lists (ACL) allow network managers to define classification actions and rules for specific ingress ports. Your switch supports up to 100 ACLs. However, the hardware resources are limited and may not be able to fully support 100 completely populated ACLs.

Packets can be filtered on ingress or egress. If the filter rules match, then some actions can be taken, including dropping the packet or disabling the port. For example, a network administrator defines an ACL rule that says port number 20 can receive TCP packets. However, if a UDP packet is received the packet is dropped.

ACLs are composed of access control entries (ACE), or rules, that consist of the filters that determine traffic classifications. The total number of rules that can be defined for each ACL is 127.

Use the **IP ACL Configuration** page to add or remove IP-based ACLs.

To display the **IP ACL Configuration** page, click **Switching** → **Network Security** → **Access Control Lists** → **IP Access Control Lists** → **Configuration** in the tree view.

Figure 7-6. IP ACL Configuration

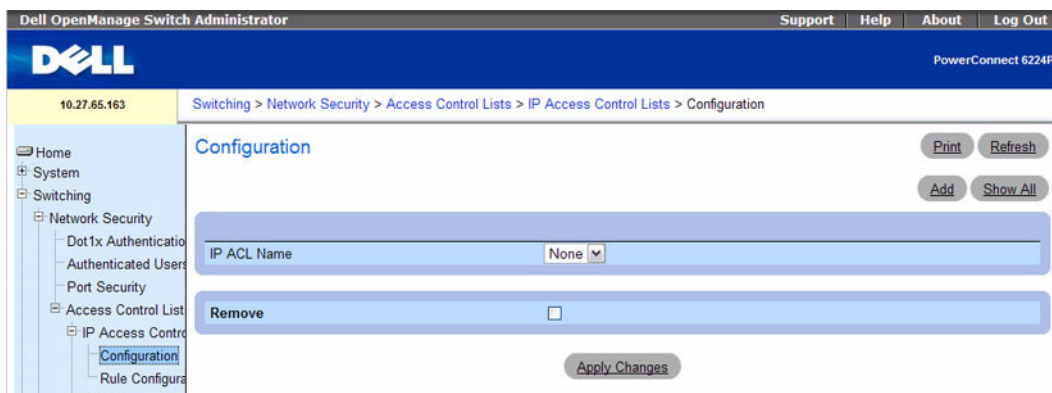

The **IP ACL Configuration** page contains the following fields:

- **IP ACL Name** — Specifies user-defined name for the ACL.
- **Remove** — Removes the IP ACL selected in the IP ACL field.

Adding an IP-based ACL

1. Open the **IP ACL Configuration** page.
2. Click **Add**.

The **Add IP ACL** page displays.

Figure 7-7. Add IP ACL

Add IP ACL Print Refresh

IP ACL Name (1 - 31 alphanumeric characters)

Apply Changes Back

3. Enter the desired **ACL Name** in the related entry field.
4. Click **Apply Changes**.
The IP-based ACL is added, and the device is updated.

Removing an IP-based ACL

1. Open the **IP ACL Configuration** page, and select the ACL to be deleted from the **IP ACL** drop-down menu.
2. Check the **Remove ACL** check box.
3. Click **Apply Changes**.
The IP-based ACL is removed, and the device is updated.

Displaying IP ACLs

1. Open the **IP ACL Configuration** page.
2. Click **Show All**.
All IP ACLs and their related data display in the **IP ACL Table**.

Figure 7-8. IP ACL Table

IP ACL Table Print Refresh

	IP ACL Name	Rules	Direction	Interface	VLAN
1	ALC1	1	NONE	NONE	
2	ACL2	1	NONE	NONE	

Back

Adding an IP-based ACL Using CLI Commands

For information about the CLI commands that perform this function, see the following chapter in the *CLI Reference Guide*:

- ACL Commands

The following table summarizes the equivalent CLI commands you use to configure an IP-based ACL.

Table 7-4. IP ACL Commands

CLI Command	Description
access-list	Creates an Access Control List
show ip access-lists	Displays access lists applied on interfaces and all rules that are defined for the access lists.

IP ACL Rule Configuration

Use the **IP ACL Rule Configuration** page to define rules for IP-based ACLs. The access list definition includes rules that specify whether traffic matching the criteria is forwarded normally or discarded. Additionally, you can specify to assign traffic to a particular queue, filter on some traffic, change VLAN tag, shut down a port, and/or redirect the traffic to a particular port.

 **NOTE:** There is an implicit "deny all" rule at the end of an ACL list. This means that if an ACL is applied to a packet and if none of the explicit rules match, then the final implicit "deny all" rule applies and the packet is dropped.

To display the **IP ACL Rule Configuration** page, click **Switching** → **Network Security** → **Access Control Lists** → **IP Access Control Lists** → **Rule Configuration** in the tree view.

Figure 7-9. IP ACL - Rule Configuration (Standard)

The screenshot displays the Dell OpenManage Switch Administrator interface for configuring an IP ACL rule. The breadcrumb trail indicates the path: Switching > Network Security > Access Control Lists > IP Access Control Lists > Rule Configuration. The main configuration area is titled "Rule Configuration" and includes the following fields:

- IP ACL Name:** A dropdown menu set to "IPACL1".
- Rule ID:** A dropdown menu set to "Create New Rule" and a text input field containing "(1-127)".
- Action:** A dropdown menu set to "Deny".
- Assign Queue ID:** A checkbox (unchecked) and a text input field with "(0 to 6)".
- Redirect Interface:** Radio buttons for "Unit" (set to "1") and "Port" (set to "g1").
- Mirror Interface:** Radio buttons for "Unit" (set to "1") and "Port" (set to "g1").
- Logging:** A checkbox (unchecked).
- Match Every:** A checked checkbox.
- Protocol:** Radio buttons for "Select From List" (set to "IP") and "Match to Value" (set to "(1 to 255)").
- Source IP Address:** A text input field with "(X.X.X.X)" and a "Wild Card Mask" field with "(X.X.X.X)".
- Source L4 Port:** Radio buttons for "Select From List" and "Match to Port" (set to "(0 to 65535)").
- Destination IP Address:** A text input field with "(X.X.X.X)" and a "Wild Card Mask" field with "(X.X.X.X)".
- Destination L4 Port:** Radio buttons for "Select From List" and "Match to Port" (set to "(0 to 65535)").
- Service Type:**
 - IP DSCP:** Radio buttons for "Select From List" and "Match to Value" (set to "(0 to 63)").
 - IP Precedence:** A text input field with "(0 to 7)".
 - IP TOS Bits:** Radio buttons for "Match to Value" (set to "(00 to FF)") and "IP TOS Mask" (set to "(00 to FF)").

An "Apply Changes" button is located at the bottom of the configuration area.

The IP ACL Rule Configuration page contains the following fields:

- **IP ACL Name** — Specifies an existing IP ACL. To set up a new IP ACL use the "IP ACL Configuration" page.
- **Rule ID** — Selects or creates user-defined ACLs. Enter an existing Rule ID, or create a new one by selecting Create from the drop-down menu and entering the desired new Rule ID in the field next to it. The new ID is created once Apply Changes is clicked. Up to 127 rules can be created for each ACL.
- **Action** — Selects the ACL forwarding action. Choose from the drop-down menu options to apply a forwarding action. Possible values are:
 - **Permit** — Forwards packets which meet the ACL criteria.
 - **Deny** — Drops packets which meet the ACL criteria.
- **Assign Queue ID** — Click the check box to apply this criteria, then enter an identifying number from 0 to 6.

- **Redirect Interface** — Select from the drop-down list of interfaces one that packets meeting this rule can be redirected to.
- **Mirror Interface** — Select from the drop-down list of interfaces one that packets meeting this rule can be mirrored to.
- **Logging** — Enables logging for a particular ACL when the check box is selected. Logging is supported for Deny action only.
- **Match Every** — Requires a packet to match the criteria of this ACL. Click the check box to apply this criteria. Match Every is exclusive to the other filtering rules, so if checked, the other rules on the screen aren't accessible.
- **Protocol** — Requires a packet's protocol to match the protocol listed here. Click the check box to apply this criteria, then select one of the following:
 - **Select from List** — Select from the drop-down list of protocols on which the rule can be based.
 - **Match to Value** — Click to add a user-defined Protocol ID used to match packets to the rule.
- **Source IP Address** — Requires a packet's source port IP address to match the address listed here. Click the check box and enter an address to apply this criteria.
- **Wild Card Mask** — Specifies the source IP address wildcard mask. Wild card masks determines which bits are used and which bits are ignored. A wild card mask of 255.255.255.255 indicates that no bit is important. A wildcard of 0.0.0.0 indicates that all of the bits are important. This field is required when **Source IP Address** is checked.
- **Source L4 Port** — Requires a packet's TCP/UDP source port to match the port listed here. Click the check box to apply this criteria, then select one of the following from the drop-down menu:
 - **Select From List** — Click to select from a list of source ports on which the rule can be based.
 - **Match to Port** — Click to add a user-defined Port ID by which packets are matched to the rule.
- **Destination IP Address** — Requires a packet's destination port IP address to match the address listed here. Click the check box and enter an address to apply this criteria.
- **Wild Card Mask** — Specifies the Destination IP address wildcard mask. This field is required when **Destination IP Address** is checked.
- **Destination L4 Port** — Requires a packet's TCP/UDP destination port to match the port listed here. Click the check box to apply this criteria, then select one of the following:
 - **Select From List** — Select from a list of destination ports on which the rule can be based.
 - **Match to Port** — Click to add a user-defined Port ID by which packets are matched to the rule.

Service Type Fields

Select one of the following three Match fields to use in matching packets to ACLs:

- **IP DSCP** — Matches the packet DSCP value to the rule. Either the DSCP value or the IP Precedence value is used to match packets to ACLs.
 - **Select From List** — Select from a list of DSCP keyword values.

- **Match to Port** — Click to add a user-defined Port ID.
- **IP Precedence** — Matches the packet IP Precedence value to the rule when checked. Enter the IP Precedence value to match. Either the DSCP value or the IP Precedence value is used to match packets to ACLs.
- **IP TOS Bits** — Matches on the Type of Service bits in the IP header when checked.
 - **TOS Bits** — Requires the bits in a packet’s TOS field to match the two-digit hexadecimal number entered here.
 - **TOS Mask** — Specifies the bit positions used for comparison against the IP TOS field in a packet.
- **Remove** — Removes a Rule ID when **Remove** is checked and **Apply Changes** is clicked.

Modifying an IP-based Rule



NOTE: Rules can be modified only when the ACL to which they belong is not bound to an interface.

1. Open the **IP ACL Rule Configuration** page.
2. Select the desired ACL from the **IP ACL** drop-down menu.
3. Select the desired rule from the **Rule ID** drop-down menu.
4. Modify the remaining fields as needed.
5. Click **Apply Changes**.

The IP-based rule is modified, and the device is updated.

Adding a New Rule to an IP-based ACL

1. Open the **IP ACL Rule Configuration** page.
2. Select the desired ACL from the **IP ACL** drop-down menu.
3. Select **Create Rule** from the **Rule ID** drop-down menu and enter a new ID number.
4. Define the remaining fields as needed.
5. Click **Apply Changes**.

The new rule is assigned to the specified IP-based ACL.

Defining an IP-based ACL Rule Using CLI Commands

For information about the CLI commands that perform this function, see the following chapter in the *CLI Reference Guide*:

- ACL Commands

The following table summarizes the equivalent CLI commands you use to configure an IP-based ACL rule.

Table 7-5. IP Access Rule Command

CLI Command	Description
access-list	Use this command to specify rules for the IP access list.
show ip access-lists	Displays an Access Control List (ACL) and all of the rules that are defined for the ACL.

MAC ACL Configuration

The **MAC ACL Configuration** page allows network administrators to define a MAC-based ACL. For an explanation of ACLs, see "IP ACL Configuration."

To display the **MAC ACL Configuration** page, click **Switching** → **Network Security** → **Access Control Lists** → **MAC Access Control Lists** → **Configuration** in the tree view.

Figure 7-10. MAC ACL Configuration

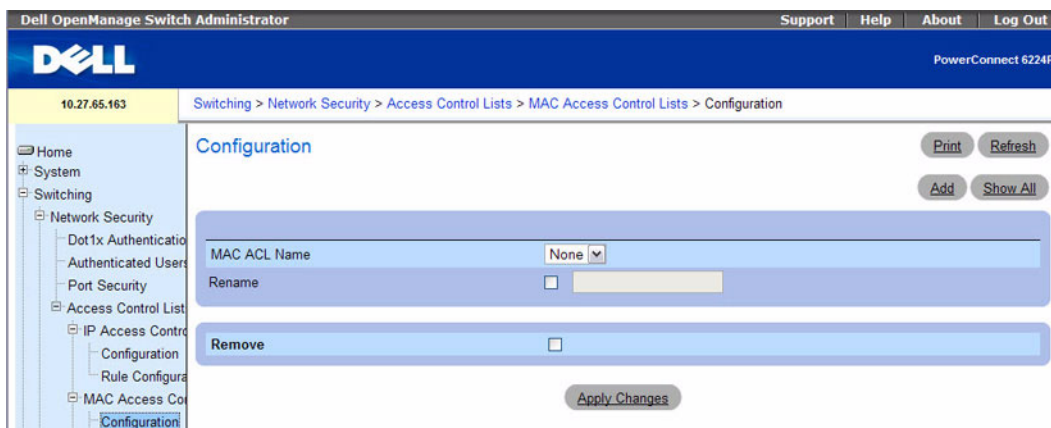

The **MAC ACL Configuration** page contains the following fields:

- **MAC ACL Name** — User-defined ACL name.
- **Rename MAC ACL** — To rename the MAC ACL, select the check box and enter a new MAC ACL name in the field.
- **Remove** — Click this field, then click the **Apply Changes** button to delete the MAC ACL listed in the MAC ACL field.

Adding a MAC-based ACL

1. Open the **MAC ACL Configuration** page.
2. Click **Add** to display the **Add MAC ACL** page.

Figure 7-11. Add MAC ACL

Add MAC ACL

MAC ACL Name (1 - 31 alphanumeric characters)

Apply Changes Back

3. Enter the desired MAC ACL Name in the entry field.
4. Click **Apply Changes**.
The MAC-based ACL is added, and the device is updated.

Removing a MAC-based ACL

1. Open the MAC ACL Configuration page, and select the ACL to be removed from the MAC ACL drop-down menu.
2. Select the **Remove** check box.
3. Click **Apply Changes**.
The MAC-based ACL is removed, and the device is updated.

Displaying MAC ACLs

1. Open the MAC ACL Configuration page.
2. Click **Show All**.
All MAC ACLs and their related data are displayed on screen.

Figure 7-12. MAC ACL Table

MAC ACL Table

MAC ACL Name	Rules	Direction	Interface	VLAN
1	big_mac	1	NONE	NONE

Back

Configuring MAC-based ACLs Using CLI Commands

For information about the CLI commands that perform this function, see the following chapter in the *CLI Reference Guide*:

- ACL Commands

The following table summarizes the equivalent CLI commands you use to define a MAC ACL.

Table 7-6. MAC ACL Commands

CLI Command	Description
mac access-list	Configures conditions required to allow traffic based on MAC addresses.
show mac access-lists	Displays a MAC access list and all of the rules that are defined for the ACL.

MAC ACL Rule Configuration

Use the **MAC ACL Rule Configuration** page to define rules for MAC-based ACLs. The access list definition includes rules that specify whether traffic matching the criteria is forwarded normally or discarded. A default 'deny all' rule is the last rule of every list.

To display the **MAC ACL Rule Configuration** page, click **Switching** → **Network Security** → **Access Control Lists** → **MAC Access Control Lists** → **Rule Configuration** in the tree view.

Figure 7-13. MAC ACL - Rule Configuration

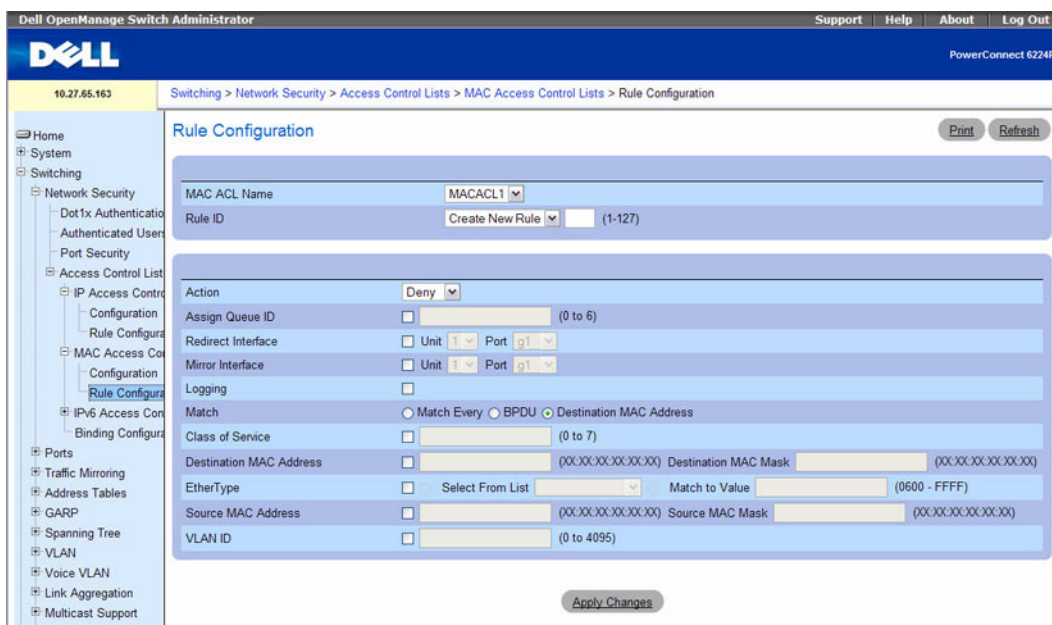

The **MAC ACL Rule Configuration** page contains the following fields:

- **MAC ACL Name** — Specifies an existing MAC ACL. To set up a new MAC ACL use the **MAC ACL Configuration** page.

- **Rule Id** — Selects or creates a user-defined ACLs. Enter an existing Rule ID, or create a new one by selecting Create from the drop-down menu and entering the desired new Rule ID in the field next to it. The new ID is created once Apply Changes is clicked.
- **Action** — Selects the ACL forwarding action, which can be one of the following values:
 - **Permit** — Forwards packets which meet the ACL criteria.
 - **Deny** — Drops packets which meet the ACL criteria.
- **Assign Queue ID** — Click the check box to apply this criteria, then enter an identifying number from 0 to 6.
- **Redirect Interface** — Select from the drop-down list of interfaces one that packets meeting this rule can be redirected to.
- **Mirror Interface** — Select from the drop-down list an interface that packets meeting this rule can be mirrored to.
- **Logging** — Click the check box to enable logging for this ACL. This feature is supported for the Deny action only.
- **Match Every** — Requires a packet to match the criteria of this ACL. Click the check box to apply this criteria.
- **Class of Service** — Requires a packet's CoS to match the CoS value listed here. Click the check box and enter a CoS value between 0 and 7 to apply this criteria.
- **Secondary CoS** — Requires a packet's secondary CoS to match the CoS value listed here. Click the check box and enter a CoS value between 0 and 7 to apply this criteria.
- **Destination MAC Address** — Requires a packet's destination port MAC address to match the address listed here. Click the check box and enter an address to apply this criteria.
- **Destination MAC Mask** — Enter the MAC Mask associated with the Destination MAC to match.
- **EtherType** — Requires a packet's EtherType to match the EtherType listed here. Click the check box and select from a list or enter the EtherType ID:
 - **Select from List** — Select desired EtherType from the drop-down menu.
 - **Match to Value** — Enter the desired port number to match.
- **Source MAC Address** — Requires a packet's source port MAC address to match the address listed here. Click the check box and enter an address to apply this criteria.
- **Source MAC Mask** — If desired, enter the MAC mask for the source MAC address to match.
- **Vlan Id** — Requires a packet's VLAN ID to match the ID listed here. Click the check box and enter the VLAN ID to apply this criteria. Possible field values are 1–4095.
- **Remove** — Removes the MAC ACL Rule when **Remove** is checked and **Apply Changes** is clicked.

Modifying a MAC-based Rule



NOTE: Rules can be modified only when the ACL to which they belong is not bound to an interface.

1. Open the **MAC ACL Rule Configuration** page.
2. Select the desired ACL from the **MAC ACL** drop-down menu.
3. Select the desired rule from the **Rule ID** drop-down menu.
4. Modify the remaining fields as needed.
5. Click **Apply Changes**.

The MAC-based rule is modified, and the device is updated.

Adding a New Rule to a MAC-based ACL

1. Open the **MAC ACL Rule Configuration** page.
2. Select the desired ACL from the **MAC ACL** drop-down menu.
3. Specify **Create New Rule** for **Rule ID**.
4. Enter a new ID number.
5. Define the remaining fields as needed.
6. Click **Apply Changes**.

The new rule is assigned to the specified MAC-based ACL.

Removing a Rule From a MAC-based ACL

1. Select an ACL.
2. Select a rule from the **Rule ID** drop-down menu.
3. Check the **Remove** check box.
4. Click **Apply Changes**.

The MAC-based ACL is removed, and the device is updated.

Configuring MAC-based ACLs Rules Using CLI Commands

For information about the CLI commands that perform this function, see the following chapter in the *CLI Reference Guide*:

- ACL Commands

The following table summarizes the equivalent CLI commands you use to define a MAC ACL.

Table 7-7. MAC ACL Commands

CLI Command	Description
deny permit	Use the deny command to deny traffic if the conditions defined in the deny statement are matched. Use the permit command in Mac-Access-List Configuration mode to allow traffic if the conditions defined in the permit statement are matched.
show mac access-list	Displays a MAC access list and all of the rules that are defined for the ACL.

IPv6 Access Control Lists

An IPv6 ACL consists of a set of rules which are matched sequentially against a packet. When a packet meets the match criteria of a rule, the specified rule action (Permit/Deny) is taken and the additional rules are not checked for a match. On this menu the interfaces to which an IPv6 ACL applies must be specified, as well as whether it applies to inbound or outbound traffic. Rules for the IPv6 ACL are specified/created using the IPv6 ACL Rule Configuration menu.

First, you use the **IPv6 ACL Configuration** page to define the IP ACL type and assign an ID to it. Then, you use the IPv6 ACL Rule Configuration page to create rules for the ACL. Finally, you use the ACL Interface Configuration and/or ACL Interface/VLAN Summary pages to assign the ACL by its ID number to a port or VLAN. You can use the **IPv6 ACL Table** page to view the configurations. See "Displaying IPv6 ACLs" on page 313.

IPv6 ACL Configuration

Use the **IPv6 ACL Configuration** page to add or remove IP-based ACLs. To display the IP ACL Configuration page, click **Switching** → **Network Security** → **Access Control Lists** → **IPv6 Access Control Lists** → **IPv6 ACL Configuration** in the tree view.

Figure 7-14. IPv6 ACL Configuration

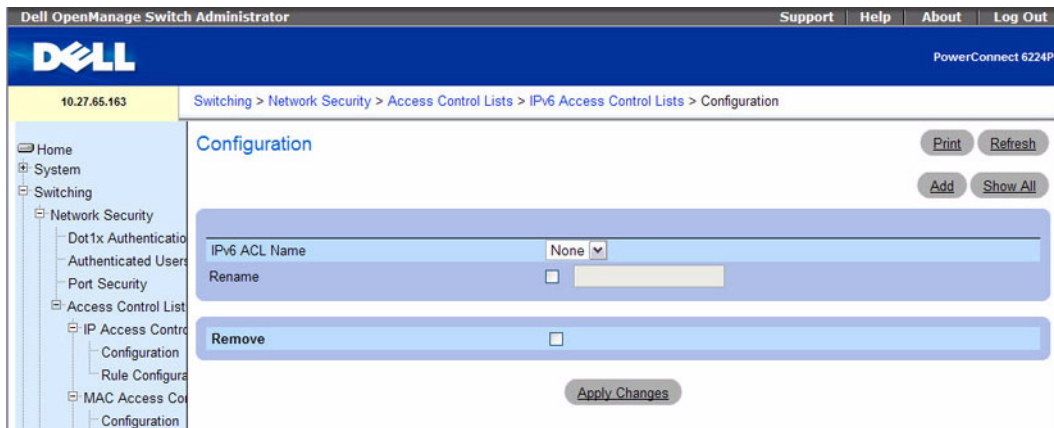

The IPv6 ACL Configuration page contains the following fields:

- **IPv6 ACL Name** — Specify an IPv6 ACL name string which includes alphanumeric characters only. The name must start with an alphabetic character. This field displays the name of the currently selected IPv6 ACL if any ACLs have already been created.
- **Rename** — To rename an existing IPv6 ACL, select this option, enter a new name in the text field, and click **Apply Changes**. The changes are applied to the ACL that is selected in the IPv6 ACL Name field.
- **Remove** — To remove an existing IPv6 ACL, select the ACL from the IPv6 ACL Name menu, select the remove option, and click **Apply Changes**.

Adding an IPv6-based ACL

1. Open the IPv6 ACL Configuration page.
2. Click **Add**.

The Add IPv6 ACL page displays.

Figure 7-15. Add IPv6 ACL



3. Enter a name for the IPv6 ACL.
4. Click **Apply Changes**.

Displaying IPv6 ACLs

1. Open the IPv6 ACL Configuration page.
2. Click Show All.
All IP ACLs and their related data display in the IPv6 ACL Table.

Figure 7-16. IPv6 ACL Table

	IPv6 ACL Name	Rules	Direction	Interface	VLAN
1	ACLV6	0	In Bound		

The Summary page has the following fields:

- **IPv6 ACL Name** — Describes the number ranges for IPv4 ACL standard versus extended. The range for a standard IP ACL is 1-99. For an extended IP ACL, the ID range is 101-199.
- **Rules** — Shows the number of rules currently configured for the IP ACL.
- **Direction** — Shows the direction of packet traffic affected by the IP ACL, which can be Inbound or blank.
- **Interface** — Shows the interfaces to which the IP ACL applies.
- **VLAN ID** — The VLAN(s) to which the IPv6 ACL applies.

Configuring an IPv6 ACL by Using CLI Commands

For information about the CLI commands that perform this function, see the following chapter in the *CLI Reference Guide*:

- ACL Commands

The following table summarizes the equivalent CLI commands you use to configure an IPv6 ACL.

Table 7-8. IPv6 ACL Commands

CLI Command	Description
ipv6 access-list	Creates an IPv6 Access Control List (ACL) consisting of classification fields defined for the IP header of an IPv6 frame.
show ipv6 access-lists	Displays an IPv6 access list (and the rules defined for it).

IPv6 ACL Rule Configuration

Use the IPv6 ACL Rule Configuration page to define rules for IPv6-based ACLs. The access list definition includes rules that specify whether traffic matching the criteria is forwarded normally or discarded. Additionally, you can specify to assign traffic to a particular queue, filter on some traffic, change VLAN tag, shut down a port, and/or redirect the traffic to a particular port. By default, no specific value is in effect for any of the IPv6 ACL rules.

There is an implicit “deny all” rule at the end of an ACL list. This means that if an ACL is applied to a packet and if none of the explicit rules match, then the final implicit “deny all” rule applies and the packet is dropped.

To display the IPv6 ACL Rule Configuration page, click **Switching** → **Network Security** → **Access Control Lists** → **IPv6 Access Control Lists** → **Rule Configuration** in the navigation menu.

Figure 7-17. IPv6 ACL - Rule Configuration

The screenshot shows the Dell OpenManage Switch Administrator interface. The breadcrumb navigation is: Switching > Network Security > Access Control Lists > IPv6 Access Control Lists > Rule Configuration. The page title is "Rule Configuration".

Fields and options visible in the configuration form:

- IPv6 ACL Name: V6ACL1
- Rule ID: Create New Rule (1-127)
- Action: Deny
- Assign Queue ID: (0 to 6)
- Redirect Interface: Unit 1, Port g1
- Mirror Interface: Unit 1, Port g1
- Logging: (checkbox)
- Match Every: (checkbox, checked)
- Protocol: Select From List (IPv6), Match to Value (1 to 255)
- Source Prefix: (input), Source Prefix Length (input)
- Source L4 Port: Select From List, Match to Port (0 to 65535)
- Destination Prefix: (input), Destination Prefix Length (input)
- Destination L4 Port: Select From List, Match to Port (0 to 65535)
- Flow Label: (input), (0 to 1048575)
- IP DSCP Service: Select From List, Match to Value (0 to 63)

An "Apply Changes" button is located at the bottom of the form.

The IPv6 ACL Configuration page contains the following fields:

- IPv6 ACL Name — Select the ACL you want to configure.

- **Rule ID** — Select an existing Rule ID to modify or select Create Rule to configure a new ACL Rule. To create a new rule, enter a rule ID from 1–127 in the available field. New rules cannot be created if the maximum number of rules has been reached. For each rule, a packet must match all the specified criteria in order to be true against that rule and for the specified rule action (Permit/Deny) to take place.
- **Action** — Specify what action should be taken if a packet matches the rule’s criteria. The choices are Permit or Deny.
- **Assign Queue ID** — Specifies the hardware egress queue identifier used to handle all packets matching this IPv6 ACL rule. Valid range of Queue IDs is 0 to 6.
- **Redirect Interface** — Specifies the egress interface where the matching traffic stream is forced, bypassing any forwarding decision normally performed by the device. This field cannot be set if a Mirror Interface is already configured for the ACL rule.
- **Mirror Interface** — Specifies the egress interface where the matching traffic stream is copied, in addition to it being forwarded normally by the device. This field cannot be set if a Redirect Interface is already configured for the ACL rule.
- **Logging** — When set to True, logging is enabled for this ACL rule (subject to resource availability in the device). If the Access List Trap Flag is also enabled, this will cause periodic traps to be generated indicating the number of times this rule was activated during the current report interval. A fixed 5 minute report interval is used for the entire system. A trap is not issued if the ACL rule hit count is zero for the current interval. This field is visible for a Deny action.
- **Match Every** — Select True or False from the menu.
- True signifies that all packets will match the selected IPv6 ACL and rule and will be either permitted or denied. In this case, since all packets match the rule, the option of configuring other match criteria will not be offered. To configure specific match criteria for the rule, remove the rule and re-create it, or re-configure 'Match Every' to 'False' for the other match criteria to be visible.
- **Protocol** — There are two ways to configure IPv6 protocol.
 - Specify an integer ranging from 1 to 255 after selecting protocol keyword “other”. This number represents the IP protocol.
 - Select name of a protocol from the existing list of Internet Protocol (IP), Transmission Control Protocol (TCP), User Datagram Protocol (UDP), Internet Control Message Protocol (ICMP) and Internet Group Management Protocol (IGMP).
- **Source Prefix/PrefixLength** — Specify IPv6 Prefix combined with IPv6 Prefix length of the network or host from which the packet is being sent. Prefix length can be in the range (0 to 128).
- **Source L4 Port** — Specify a packet's source layer 4 port as a match condition for the selected IPv6 ACL rule. Source port information is optional. Source port information can be specified in two ways:
 - Select keyword “other” from the drop down menu and specify the number of the port in the range from 0 to 65535.

- Select one of the keyword from the list: DOMAIN, ECHO, FTP, FTPDATA, HTTP, SMTP, SNMP, TELNET, TFTP, and WWW. Each of these values translates into its equivalent port number, which is used as both the start and end of the port range.
- **Destination Prefix/Prefix Length** — Enter up to a 128-bit prefix combined with the prefix length to be compared to a packet's destination IP address as a match criteria for the selected IPv6 ACL rule. The prefix length can be in the range 0 to 128.
- **Destination L4 Port Number** — Specify a packet's destination layer 4 port number match condition for the selected IPv6 ACL rule. This is an optional configuration.
- **Destination L4 Port Keyword** — Specify the destination layer 4 port match conditions for the selected IPv6 ACL rule. The possible values are DOMAIN, ECHO, FTP, FTPDATA, HTTP, SMTP, SNMP, TELNET, TFTP, and WWW. Each of these values translates into its equivalent port number, which is used as both the start and end of the port range. This is an optional configuration.
- **Flow Label** — A 20-bit number that is unique to an IPv6 packet that is used by end stations to signify QoS handling in routers. The flow label can specified within the range 0 to 1048575.
- **IPv6 DSCP Service** — Specify the IP DiffServ Code Point (DSCP) value, which is defined as the high-order six bits of the Service Type octet in the IPv6 header. This is an optional configuration. Enter an integer from 0 to 63. The IPv6 DSCP can be selected from one of the DSCP keywords in the menu. To specify a DSCP by its numeric value, select the Other option in the menu, and a text box displays for entering the numeric value.

Configuring an IPv6 ACL Rule by Using CLI Commands

For information about the CLI commands that perform this function, see the following chapter in the *CLI Reference Guide*:

- ACL Commands

The following table summarizes the equivalent CLI commands you use to configure IPv6 ACL rules.

Table 7-9. IPv6 ACL Rule Command

CLI Command	Description
ipv6 access-list	Creates an IPv6 Access Control List (ACL) consisting of classification fields defined for the IP header of an IPv6 frame.
show ipv6 access-lists	Displays an IPv6 access list (and the rules defined for it).

ACL Bind Configuration

When an ACL is bound to an interface, all the rules that have been defined are applied to the selected interface. Use the **ACL Bind Configuration** page to assign ACL lists to ACL Priorities and Interfaces.

From the Web interface, you can configure the ACL rule in the ingress or egress direction so that the ACLs implement security rules for packets entering or exiting the port. You can apply ACLs to any physical (including 10 Gb) interface, LAG, or routing port.

 **NOTE:** Binding an ACL in the egress direction is not supported by the PowerConnect 6200 Series switches. IP ACLs may be bound to an Ethernet interface in the egress direction.

To display the ACL Bind Configuration page, click **Switching** → **Network Security** → **Access Control Lists** → **Binding Configuration** in the tree view.

Figure 7-18. ACL Bind Configuration

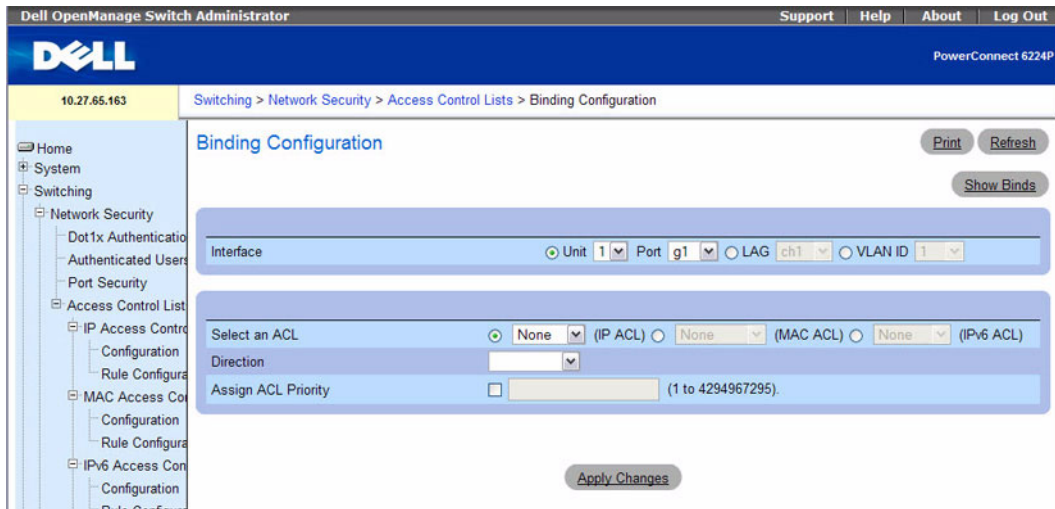

The ACL Bind Configuration page contains the following fields:

- **Interface** — Radio buttons permit selection of interface by Unit/port, LAG, or VLAN.
- **Select an ACL** — Selects the ACL type to which incoming packets are matched. Packets can be matched to IP-based, MAC-based, or IPv6-based ACLs. Valid combinations of ACLs that can be bound to any interface or VLAN are:
 - IP and MAC ACLs can be bound together to an interface or VLAN but not to IPv6 ACLs.
- **Direction** — Specifies the packet filtering direction for ACL. Binding ACL for Interface and LAGs are:
 - IPv4 ACLs can be bound in both inbound and outbound.
 - MAC and IPv6 ACLs can be bound only in the inbound direction on the PowerConnect 6200 Series switches.
 - VLANs — IPv4, MAC, and IPv6 ACLs can only be bound in the inbound direction on the PowerConnect 6200 Series switches.
 - Assign ACL Priority — Assigns the priority of this ACL. If more than one ACL is applied to an interface, then the match criteria for the highest priority ACLs are checked first.

Assigning an ACL to an Interface

1. Open the **ACL Bind Configuration** page.
2. In the **Interface** field, specify the Unit and Port, LAG, or VLAN to configure.
3. Select the IP, IPv6, or MAC ACL in the **Select an ACL** field.
 **NOTE:** Whenever an ACL is assigned on a port, LAG, or VLAN, flows from that ingress interface that do not match the ACL are matched to the default rule, which is Drop unmatched packets.
4. Specify the priority in **Assign ACL Priority**.
5. Click **Apply Changes**.
The ACL is attached to the specified interface(s).

Removing an Interface from an ACL

1. Open the **ACL Bind Configuration** page.
2. Click **Show All**.
3. In the **Interface** field, specify the Unit and Port, LAG, or VLAN to view the ACL bindings for that interface.
4. Select the **Remove** check box for one or more ACLs to remove.
5. Click **Apply Changes**.
The specified ACL(s) are removed from the interface.

Assigning ACL Membership Using CLI Commands

For information about the CLI commands that perform this function, see the following chapter in the *CLI Reference Guide*:

- ACL Commands

The following table summarizes the equivalent CLI commands you use to bind an IPv6 ACL to an interface or VLAN ID.

Table 7-10. IPv6 ACL Bind Configuration Commands

CLI Command	Description
ipv6 traffic-filter	This command either attaches a specific IPv6 Access Control List (ACL) to an interface or associates it with a VLAN ID in a given direction.
ip access-group	Applies an IP based egress ACL on an Ethernet interface or a group of interfaces.

Configuring Ports

The **Ports** menu page provides links for configuring port functionality, including advanced features such as storm control and port mirroring, and for performing virtual port tests.

To display the page, click **Switching** → **Ports** in the tree view. The **Ports** menu page contains links to the following features:

- Global Parameters
- Port Configuration
- Protected Port Configuration
- LAG Configuration
- Storm Control

Global Parameters

Use the Global Parameters to configure Flow Control. Flow Control allows traffic from one switch to be throttled for a specified period of time, and is defined for switches that are directly connected. Flow Control can only be set for ports configured as full-duplex mode of operation. Since ports set to auto negotiate may not be added as LAG members, LAG member ports cannot have flow control configured to auto.

 **NOTE:** Flow Control is incompatible with head of line blocking prevention mode. The switch can operate in either mode, but not at the same time.

To display the **Global Parameters** page, click **Switching** → **Ports** → **Global Parameters** in the tree view.

Figure 7-19. Global Port Parameters

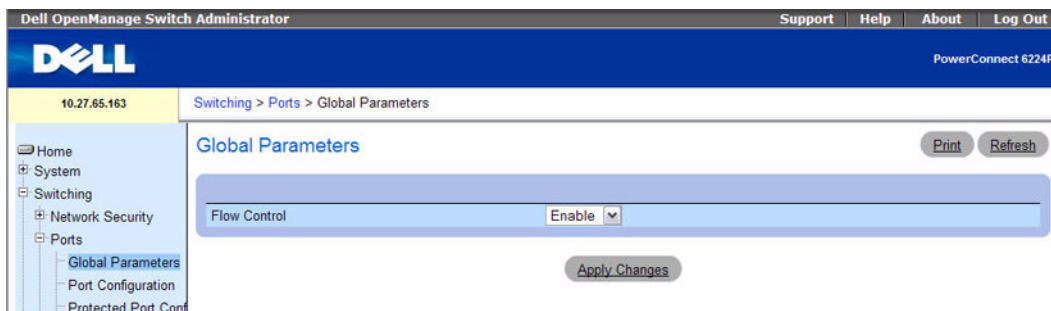

The **Global Parameters** page contains the following field:

- **Flow Control** — Select enabled or disabled from the drop-down menu. This command affects all ports in the stack. The default value is enabled.
 - **Enable** — Turns on the ingress back pressure mechanism of the switch.
 - **Disable** — Restores the switch operation to head of line blocking prevention.

Enabling Ingress Backpressure

1. Open the **Ports Global Parameters** page.
2. Select **Enable** from the drop-down menu in the **Flow Control** field.
3. Click **Apply Changes**.
4. Ingress backpressure is now enabled.

Configuring Flow Control Using CLI Commands

For information about the CLI commands that perform this function, see the following chapter in the *CLI Reference Guide*:

- Ethernet Configuration Commands

The following table summarizes the equivalent CLI commands for this feature.

Table 7-11. Port Configuration Commands

CLI Command	Description
flowcontrol	Enables flow control.
show interfaces configuration	Displays the configuration for all configured interfaces.

Port Configuration

Use the Port Configuration page to define port parameters.

To display the Port Configuration page, click **Switching** → **Ports** → **Port Configuration** in the tree view.

Figure 7-20. Port Configuration

The screenshot shows the Dell OpenManage Switch Administrator interface. The top navigation bar includes 'Support', 'Help', 'About', and 'Log Out'. The breadcrumb trail is 'Switching > Ports > Port Configuration'. The left sidebar shows a tree view with 'Port Configuration' selected. The main content area is titled 'Port Configuration' and contains the following fields:

Port	Unit 1 Port g1
Description	(0 to 64 characters)
Admin Status	Enable
Current Port Status	Link Down
Current Port Speed	Unknown
Admin Port Speed	10
Maximum Frame Size	1518 (1518 to 9216)
Admin Duplex	Half
Current Duplex Mode	N/A
Auto Negotiation	Enable
Current Auto Negotiation	Enable
Admin Advertisement	<input checked="" type="checkbox"/> Max Capacity <input type="checkbox"/> 10 Full <input type="checkbox"/> 10 Half <input type="checkbox"/> 100 Half <input type="checkbox"/> 100 Full <input type="checkbox"/> 1000 Full
LAG	not a lag member
Transceiver firmware part number	
Transceiver firmware revision	
Current Flow Control	Inactive

Buttons: Print, Refresh, Show All, Apply Changes

The Port Configuration page contains the following fields:

- **Port** — Specifies the Unit and Port for which port parameters are defined.
- **Description (0–64 Characters)** — Provides a brief interface description, such as Ethernet.
- **Admin Status** — Enables (Up) or disables (Down) traffic forwarding through the port.
- **Current Port Status** — Specifies whether the port is currently operational or non-operational.
- **Current Port Speed** — Displays the actual synchronized port speed (bps).
- **Admin Port Speed** — Forces the port speed to the selected 10M 100M value.
- **Maximum Frame Size (1518–9216)**— Specifies the threshold beyond which packets exceeding this size are dropped. Default is 1518.

- **Admin Duplex** — Specifies the port duplex mode.
 - **Full** — Indicates that the interface supports transmission between the switch and the client in both directions simultaneously.
 - **Half** — Indicates that the interface supports transmission between the switch and the client in only one direction at a time.
- **Current Duplex Mode** — Displays the synchronized port duplex mode.
- **Auto Negotiation** — Enables Auto Negotiation on the port. Auto Negotiation is a protocol between two link partners that enables a port to advertise its transmission rate, duplex mode, and flow control abilities to its partner.
- **Current Auto Negotiation** — Displays the current Auto Negotiation setting.
 - **1000 Full** — Indicates that the port is advertising a 1000 mbps speed and full-duplex mode setting.
 - **10000 Full** — Indicates that the port is advertising a 10000 mbps speed and full-duplex mode setting.
- **LAG** — Displays LAG number if this port is a member of a LAG.
- **Current Flow Control** — Indicates the current Flow Control settings. Possible field values are:
 - **Active** — Flow Control is active.
 - **Inactive** — Flow Control is inactive.
- **Transceiver Firmware Version** — Displays firmware part number of port transceiver, if available. Valid only for SFX7101 transceivers on 10GBase-T non-stacking ports.
- **Image Firmware Version** — Displays the version of the image on the firmware.
- **Firmware Update Status** — Indicates the statue of the firmware on the switch:
 - **Up-to-date** — The firmware status is current.
 - **Outdated** — The firmware status is not current.
- **Max. Cable Length**— Displays the maximum cable length determined by current power backoff level.

Defining Port Parameters

1. Open the **Port Configuration** page.
2. Select a unit and port in the **Unit** and **Port** fields.
3. Define the available fields on the screen.
4. Click **Apply Changes**.

The port parameters are saved to the switch.

Displaying the Port Table

1. Open the **Port Configuration** page.

2. Click Show All.

The **Port Configuration Table** displays.

Figure 7-21. Port Configuration Table

Port	Port Status	Port Speed	Max Frame Size	Duplex Mode	Auto Negotiation	Flow Control	MDI/MDIX	Copy To	Edit
1 1/xg1	Up	1000	1518	Full	Disable	Disable	Auto	<input type="checkbox"/>	<input checked="" type="checkbox"/>
2 1/xg2	Up	10	1518	Full	Disable	Disable	Auto	<input type="checkbox"/>	<input type="checkbox"/>

3. Use the **Unit** drop-down menu to view the **Port Configuration Table** for other units in the stack, if they exist.

Copying Port Configuration Settings

1. Open the **Port Configuration** page.
2. Click Show All.
The **Port Configuration Table** displays.
3. Specify the Unit and Port you are copying from in **Copy Parameters From**.
4. Click **Copy To** for each Port to receive these parameters.
5. Click **Apply Changes**.
The Port Configuration settings are copied, and the device is updated.

Modifying Port Configuration Settings for Multiple Ports

1. Open the **Port Configuration** page.
2. Click Show All.
The **Port Configuration Table** displays.
3. Click **Edit** for each Port to modify.
4. Edit the Port Configuration fields as needed.
5. Click **Apply Changes**.
The Port Configuration settings are modified, and the device is updated.

Configuring Ports with CLI Commands

For information about the CLI commands that perform this function, see the following chapter in the *CLI Reference Guide*:

- Ethernet Configuration Commands

The following table summarizes the equivalent CLI commands for this feature.

Table 7-12. Port Configuration Commands

CLI Command	Description
description	Adds a description to an interface.
duplex	Configures the full/half-duplex operation of a given Ethernet interface when not using auto-negotiation.
interface ethernet	Enters the interface configuration mode to configure an Ethernet type interface.
interface range ethernet	Enters the interface configuration mode to configure multiple Ethernet type interfaces.
mtu	Enables jumbo frames on an interface by adjusting the maximum size of a packet or maximum transmission unit (MTU).
negotiation	Enables auto-negotiation operation for the duplex parameters of a given interface.
speed	Configures the speed of a given Ethernet interface when not using auto-negotiation.
show interfaces advertise	Displays information about auto negotiation advertisement.
show interfaces configuration	Displays the configuration for all configured interfaces.
show interfaces description	Displays the description for all configured interfaces.
show interfaces detail	Displays the detail for all configured interfaces.
show interfaces status	Displays the status for all configured interfaces.
shutdown	Disables interfaces.

Protected Port Configuration

Use the **Protected Port Configuration** page to specify a Layer 2 security feature, Private VLAN Edge (PVE) ports, that provides port-based security between ports that are members of the same VLAN. Traffic from protected ports is sent only to the uplink ports and cannot be sent to other ports within the VLAN.

To display the **Port Configuration** page, click **Switching** → **Ports** → **Protected Port Configuration** in the tree view.

Figure 7-22. Protected Port Configuration

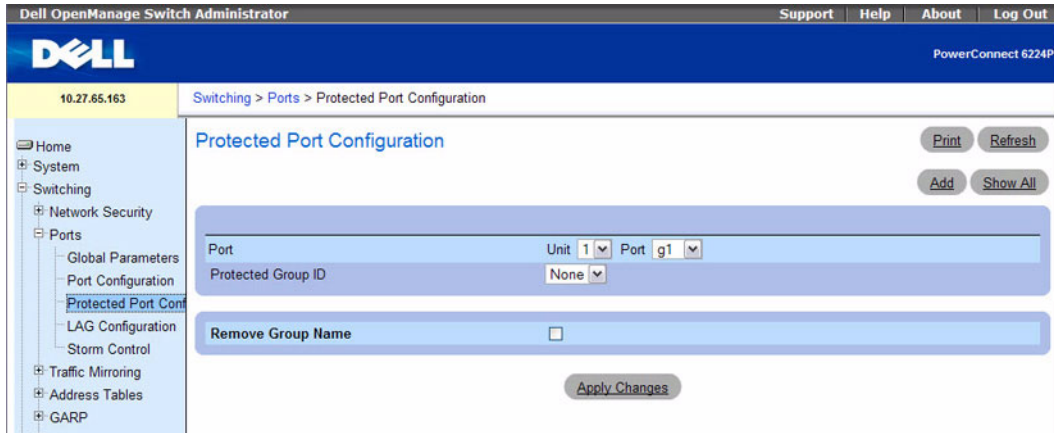

The Protected Port Configuration page contains the following fields:

- **Port** — Specifies the Unit and Port for which port parameters are defined.
- **Protected Group ID** — Drop-down menu used to assign a port to Group 0, 1, or 2.
- **Remove Group Name** — Check this box to disassociate the selected port from the protected group.

Displaying the Protected Port Table

1. Open the Protected Port Configuration page.
2. Click Show All.

The Protected Ports Summary table displays.

Figure 7-23. Protected Port Summary Table

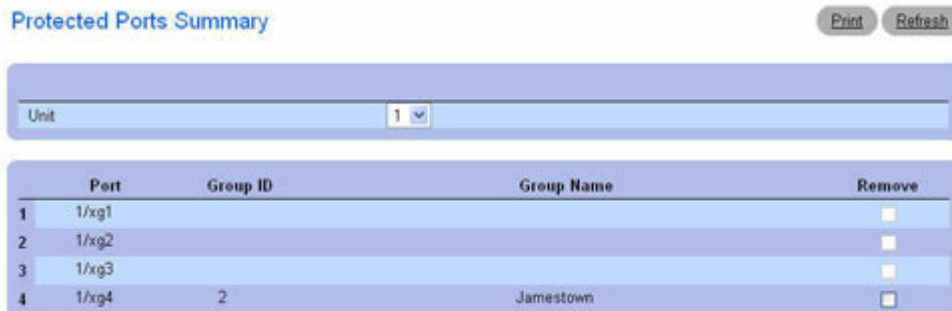

3. Select the Remove check box and click Apply Changes to disassociate a port from a protected group.

- Use the **Unit** drop-down menu to view the **Protected Port Summary** table for other units in the stack, if they exist.

Adding Protected Port Groups

- Open the **Protected Port Configuration** page.
- Click **Add**.

The **Add Protected Group** displays.

Figure 7-24. Add Protected Port

- Use the drop-down menu to assign the numeric designation 0, 1, or 2 to the **Protected Group ID**.
- Enter a **Protected Group Name (1–32 characters)**.
- Click **Apply Changes**.

The Protected Group settings are copied, and the device is updated.

Configuring Protected Ports With CLI Commands

For information about the CLI commands that perform this function, see the following chapter in the *CLI Reference Guide*:

- Switchport Protected Commands

The following table summarizes the equivalent CLI commands for this feature.

Table 7-13. Protected Port Commands

CLI Command	Description
show switchport protected	Displays protected group/port information.
switchport protected	Configure a protected port.
switchport protected name	Configures a name for a protected group

LAG Configuration

Link Aggregation allows one or more full-duplex Ethernet links to be aggregated together to form a Link Aggregation Group (LAG). The switch can treat LAG as if it were a single link.

To display the LAG Configuration page, click Switching → Ports → LAG Configuration in the tree view.

Figure 7-25. LAG Configuration

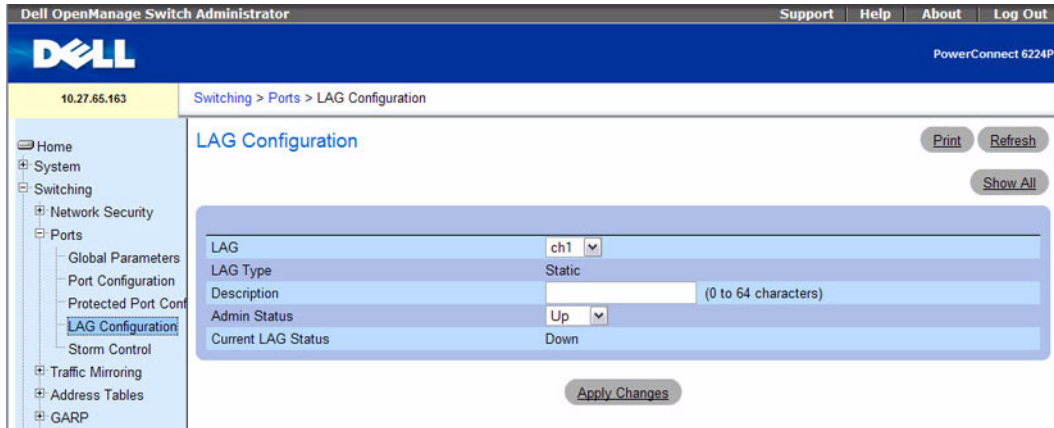

The LAG Configuration page contains the following fields:

- **LAG** — Contains a list of LAG numbers.
- **LAG Type** — The port types that comprise the LAG.
- **Description (0–64 Characters)** — Description of the port.
- **Admin Status** — Enables or disables traffic forwarding through the selected LAG.
- **Current LAG Status** — Indicates whether the selected LAG is Up or Down.

Defining LAG Parameters

1. Open the LAG Configuration page.
2. Select a LAG in the LAG field.
3. Define the available fields on the screen.
4. Click Apply Changes.
The LAG parameters are saved to the switch.

Displaying the LAG Configuration Table

1. Open the LAG Configuration page.
2. Click Show All.
3. The LAG Configuration Table displays.

Figure 7-26. LAG Configuration Table

	LAG	Description	LAG Type	Admin Status	Current Flow Control	Edit
1	lag1		Link Aggregation	Up ▼	Disable ▼	<input type="checkbox"/>
2	lag2		Link Aggregation	Up ▼	Disable ▼	<input type="checkbox"/>
3	lag3		Link Aggregation	Up ▼	Disable ▼	<input type="checkbox"/>
4	lag4		Link Aggregation	Up ▼	Disable ▼	<input type="checkbox"/>
5	lag5		Link Aggregation	Up ▼	Disable ▼	<input type="checkbox"/>
6	lag6		Link Aggregation	Up ▼	Disable ▼	<input type="checkbox"/>
7	lag7		Link Aggregation	Up ▼	Disable ▼	<input type="checkbox"/>
8	lag8		Link Aggregation	Up ▼	Disable ▼	<input type="checkbox"/>

Editing LAG Parameters

1. Open the LAG Configuration page.
2. Click Show All.
3. The LAG Configuration Table displays.
4. Check Edit for all LAGs to be modified.
5. Admin Status and Description can now be edited as needed.
6. Click Apply Changes.

The LAG parameters are saved to the switch.

Configuring LAGs with CLI Commands

For information about the CLI commands that perform this function, see the following chapter in the *CLI Reference Guide*:

- Port Channel Commands

The following table summarizes the equivalent CLI commands for this feature.

Table 7-14. LAG Commands

CLI Command	Description
channel-group	Configure a port-to-port channel.
description	Adds a description to a LAG .
hashing-mode	Sets the hashing algorithm on trunk ports.
interface port-channel	Configure a port-channel type and enters port-channel configuration mode.
interface range port-channel	Use this command in Global Configuration mode to execute a command on multiple port channels at the same time.
show interfaces port-channel	Shows port-channel information.
shutdown	Disables an LAG.

Storm Control

A broadcast storm is the result of an excessive number of broadcast messages simultaneously transmitted across a network by a single port. Forwarded message responses can overload network resources and/or cause the network to time out.

Your switch measures the incoming broadcast/multicast/unknown unicast packet rate per port and discards packets when the rate exceeds the defined value. Storm control is enabled per interface, by defining the packet type and the rate at which the packets are transmitted.

Use the **Storm Control** page to enable and configure storm control.

To display the **Storm Control** interface, click **Switching** → **Ports** → **Storm Control** in the tree view.

Figure 7-27. Storm Control

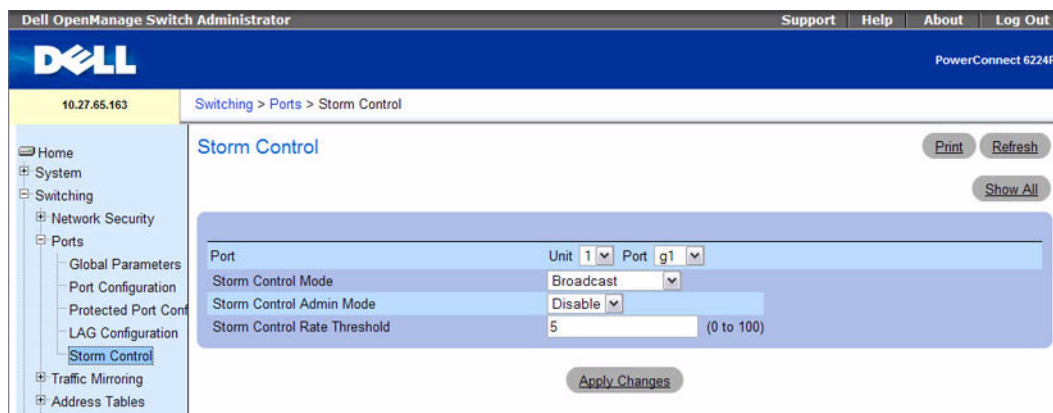

The **Storm Control** page contains the following fields:

- **Port** — Specifies the **Unit** and **Port** for which storm control is enabled.
- **Storm Control Mode** — Specifies the mode of broadcast affected by storm control.
 - **Broadcast** — If the rate of L2 broadcast traffic ingressing on an interface increases beyond the configured threshold, the traffic will be dropped.
 - **Multicast** — If the rate of L2 multicast traffic ingressing on an interface increases beyond the configured threshold, the traffic will be dropped.
 - **Unknown Unicast** — If the rate of unknown L2 unicast (destination lookup failure) traffic ingressing on an interface increases beyond the configured threshold, the traffic will be dropped.
- **Storm Control Admin Mode** — Enables or Disables Storm Control.
- **Storm Control Rate Threshold (0–100%)** — Specifies the maximum rate at which unknown packets are forwarded. The range is a percent of the total threshold.

Defining Storm Control Port Parameters

1. Open the **Storm Control** interface.
2. Edit the fields on the screen.
3. Click **Apply Changes**.

The storm control port parameters are saved to the switch.

Displaying the Storm Control Settings Table

1. Open the **Storm Control** interface.
2. Click **Show All**.

The **Storm Control Settings Table** displays.

Figure 7-28. Storm Control Settings Table

Unit	Broadcast Control Mode	Broadcast Rate Threshold	Multicast Control Mode	Multicast Rate Threshold	Unicast Control Mode	Unicast Rate Threshold	Edit
1 1/xg1	Disable	5	Disable	5	Disable	5	<input checked="" type="checkbox"/>
2 1/xg2	Disable	5	Disable	5	Disable	5	<input type="checkbox"/>
3 1/xg3	Disable	5	Disable	5	Disable	5	<input type="checkbox"/>

3. Use the **Unit** drop-down menu to view the **Storm Control Settings Table** for other units in the stack, if they exist.

Modifying Broadcast Control

1. Open the Storm Control interface.
2. Click Show All.
The Storm Control Settings Table displays.
3. Check Edit for each port that Broadcast Control is to be modified.
4. Edit Broadcast Control as needed.
5. Click Apply Changes.

The storm control port parameters are saved to the switch.

Configuring Storm Control with CLI Commands

For information about the CLI commands that perform this function, see the following chapter in the *CLI Reference Guide*:

- Ethernet Configuration Commands

The following table summarizes the equivalent CLI commands for this feature.

Table 7-15. Storm Control Commands

CLI Command	Description
storm-control broadcast	Enables broadcast storm recovery mode for a specific interface.
storm-control multicast	Enables multicast storm recovery mode for an interface.
storm-control unicast	Enables unknown unicast storm control for an interface.
show storm-control	Display the configuration of storm control.

Configuring Traffic Mirroring

Traffic mirroring allows the user to configure the switch to send copies of packets on a port that is being mirrored to the mirroring port. The mirroring can be port-based or flow-based.

Use the **Traffic Mirroring** menu page to define port mirroring sessions and configure flow-based mirroring.

To display this page, click **Switching** → **Traffic Mirroring** in the tree view. The **Traffic Mirroring** menu page contains links to the following features:

- Port Mirroring
- Flow Based Mirroring

Port Mirroring

Port mirroring selects the network traffic for analysis by a network analyzer. This is done for specific ports of the switch. As such, many switch ports are configured as source ports and one switch port is configured as a destination port. You have the ability to configure how traffic is mirrored on a source port. Packets that are received on the source port, that are transmitted on a port, or are both received and transmitted, can be mirrored to the destination port.

The packet that is copied to the destination port is in the same format as the original packet on the wire. This means that if the mirror is copying a received packet, the copied packet is VLAN tagged or untagged as it was received on the source port. If the mirror is copying a transmitted packet, the copied packet is VLAN tagged or untagged as it is being transmitted on the source port.

To display the **Port Mirroring** page, click **Switching** → **Traffic Mirroring** → **Port Mirroring** in the tree view.

Figure 7-29. Port Mirroring

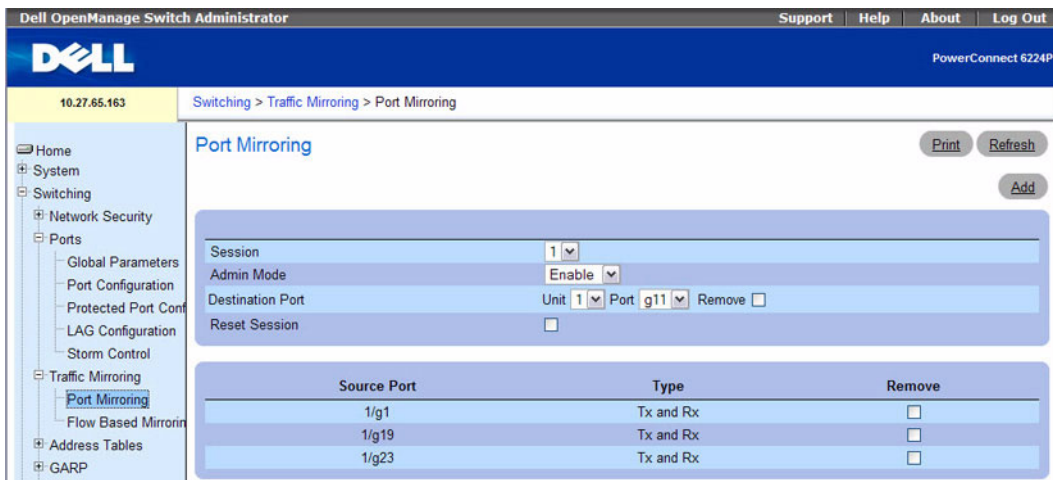

The **Port Mirroring** page contains the following fields:

- **Session** — Specifies the monitoring session.
- **Admin Mode** — Enables or Disables the port mirroring.
- **Destination Port** — Select the port to which port traffic may be copied.
- **Reset Session** — Allows you to reset the port monitoring session.
- **Source Port** — Lists the source ports that have been added from the Add Source Port page.
- **Type** — Shows the type traffic monitored on the source port.

Adding a Port Mirroring Session

 **NOTE:** A Port will be removed from a VLAN or LAG when it becomes a destination mirror.

1. Open the **Port Mirroring** page.
2. Click **Add** to display the **Add Source Port** page.

Figure 7-30. Add Source Port



3. Configure the following fields:

Session — Select the session to monitor.

Source Port — Select the unit and port from which traffic is mirrored. Up to four source ports can be mirrored to a destination port.

Type — Specifies the type of traffic monitored. Possible field values are:

TX — Monitors transmitted packets only.

RX — Monitors received packets only.

TX and RX — Monitors transmitted and received packets.

4. Click **Apply Changes**.

The new port mirroring session is enabled for the unit and port, and the device is updated. The source port appears in the Source Port table on the Port Mirroring page.

Modifying a Port Mirroring Session

1. Open the **Port Mirroring** page.
2. Modify the fields.
3. Click **Apply Changes**.

The port mirroring session fields are modified, and the device is updated.

Removing a Port Mirroring Session

1. Open the **Port Mirroring** page.
2. Select the **Reset Session** check box.
3. Click **Apply Changes**.

The port mirroring session is removed, and the device is updated.

Configuring a Port Mirroring Session Using CLI Commands

For information about the CLI commands that perform this function, see the following chapter in the *CLI Reference Guide*:

- Port Monitor Commands

The following table summarizes the equivalent CLI commands for this feature.

Table 7-16. Port Monitor Commands

CLI Command	Description
monitor session	Configure a probe port and a monitored port for monitor session (port monitoring).
show monitor session	Displays status of port monitoring.

Flow Based Mirroring

The flow based mirroring feature builds upon the DiffServ component in QoS. In QoS, the user creates traffic classes to define match criteria, then policies to define the action to be taken on that traffic class.

Flow based mirroring allows the user to copy certain types of traffic to a single destination port. This provides flexibility—instead of mirroring all ingress or egress traffic on a port, the switch can mirror a subset of that traffic. You can configure the switch to mirror flows based on Layer 2, Layer 3, and Layer 4 information.

Use the **Flow Based Mirroring** page to specify flow-based mirroring ports.

To display the **Flow Based Mirroring** page, click **Switching** → **Traffic Mirroring** → **Flow Based Mirroring** in the tree view.

Figure 7-31. Flow Based Mirroring

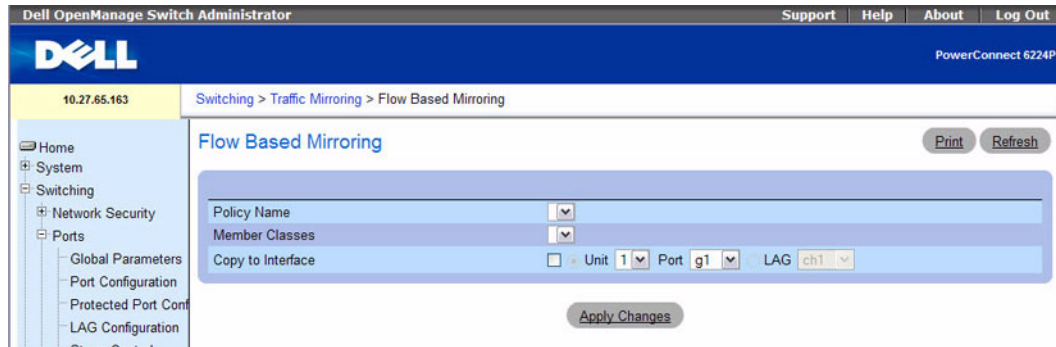

The **Flow Based Mirroring** page contains the following fields:

- **Policy Name** — Selects policy to associate with a traffic class. Policy Name is defined using the DiffServ "Policy Configuration" web page.
- **Member Classes** — Selects the traffic class associated with this policy. Member Class is defined using the DiffServ "Class Configuration" web page.
- **Copy to Interface** — When checked, this feature permits packets to be copied to either a unit/port or LAG.

Mirroring to a Destination Port

1. Open the **Flow Based Mirroring** page.
2. Specify **Policy Name** and **Member Class**, and select the destination unit and port to be affected in **Copy to Interface**.
3. Click **Apply Changes**.

The flow-based mirroring details are copied to the specified port, and the device is updated.

Configuring Flow-based Mirroring Using CLI Commands

For information about the CLI commands that perform this function, see the following chapter in the *CLI Reference Guide*:

- **QOS Commands**

The following table summarizes the equivalent CLI commands for this feature.

Table 7-17. Flow-based Mirroring Commands

CLI Command	Description
diffserv	Sets the DiffServ operational mode to active.
policy-map	Establishes a new DiffServ policy
mirror	Mirrors all the data that matches a policy to the specified destination port.

Configuring Address Tables

MAC addresses are stored in either the static or dynamic address table. Static addresses are defined by you. Dynamic addresses are learned by the system, and are erased after a time-out. A packet addressed to a destination stored in one of the tables is forwarded immediately to the ports. The static and dynamic address tables can be sorted by Interface, VLAN ID, or VLAN Name. In addition, addresses can be added to the static and dynamic address tables.

To display the **Address Tables** menu page, click **Switching** → **Address Tables** in the tree view. The **Address Tables** menu page contains links to the following features:

- **Static Address Table**
- **Dynamic Address Table**

Static Address Table

The **Static Address Table** page contains a list of static MAC addresses. A static address can be added and removed from the Static MAC Address Table.

To display the **Static Address** page, click **Switching** → **Address Tables** → **Static Address Table** in the tree view.

Figure 7-32. Static MAC Address

The **Static MAC Address** page contains the following fields:

- **Interface** — Specifies the Unit and Port or LAG to which the static MAC address is applied. To view addresses for a different Unit/Port or LAG, change the Interface listed here.
- **VLAN ID - MAC Address** — Specifies VLAN ID attached to the MAC Address and the MAC address(es) included in the current static address list.



NOTE: Only MAC addresses assigned to the specified interface and VLAN are displayed.

- **Status** — Specifies status of the MAC address. Possible values are:
 - **Permanent** — The MAC address is permanent.
 - **Secure** — Guarantees that a locked port MAC address is not deleted.
 - **Delete on Reset** — The MAC address is deleted when the switch is reset.

- **Delete on Timeout** — The MAC address is deleted when a timeout occurs.

Adding a Static MAC Address

1. Open the Static MAC Address page.
2. Click Add.

The Add Static MAC Address page displays.

Figure 7-33. Adding Static MAC Address

The screenshot shows a web-based configuration interface for adding a static MAC address. The main heading is "Add Static MAC Address" with "Print" and "Refresh" buttons to the right. Below this is a "New Entry" form with the following fields:

Interface	<input checked="" type="radio"/> Unit 1 <input type="radio"/> Port xg5 <input type="radio"/> LAG ch1
MAC Address	08:00:69:02:01:FC
<input checked="" type="radio"/> VLAN ID	2
<input type="radio"/> VLAN Name	Default
Status	Permanent

At the bottom of the form are "Apply Changes" and "Back" buttons.

3. Complete the fields as needed.
4. Click Apply Changes.

The new static address is added to the **Static MAC Address Table**, and the device is updated.

Modifying a Static Address in the Static MAC Address Table

1. Open the Static MAC Address page.
2. Modify the fields.
3. Click Apply Changes.

The static MAC address is modified, and the device is updated.

Displaying the Static MAC Address Table

1. Open the Static MAC Address page.
2. Click Show All.

The **Static MAC Address Table** displays all existing static MAC addresses.

Figure 7-34. Static MAC Address Table

	MAC	VLAN ID	Interface	Status	Remove
1	08:00:69:02:01:FC	1	1/xg1	Permanent	<input type="checkbox"/>
2	08:A6:69:02:01:28	2	1/xg5	Permanent	<input type="checkbox"/>

Removing a Static Address from the Static Address Table

1. Open the **Static MAC Address** page.
2. Click **Show All** to display the **Static MAC Address Table**.
3. Check the **Remove** check box for the address to be removed.
4. Click **Apply Changes**.

The static address is deleted, and the device is updated.

Configuring Static Address Parameters Using CLI Commands

For information about the CLI commands that perform this function, see the following chapter in the *CLI Reference Guide*:

- Address Table Commands

The following table summarizes the equivalent CLI commands for this feature.

Table 7-18. Static Address Table Commands

CLI Command	Description
bridge address	Adds a static MAC-layer station source address to the bridge table.
show bridge address-table static	Displays static entries in the bridge-forwarding database.

Dynamic Address Table

The **Dynamic Address Table** page contains fields for querying information in the dynamic address table, including the interface type, MAC addresses, VLAN, and table sorting key. Packets forwarded to an address stored in the address table are forwarded directly to those ports.

The **Dynamic Address Table** also contains information about the aging time before a dynamic MAC address is removed from the table.

To display the **Dynamic Address Table**, click **Switching** → **Address Tables** → **Dynamic Address Table** in the tree view.

Figure 7-35. Dynamic Address Table

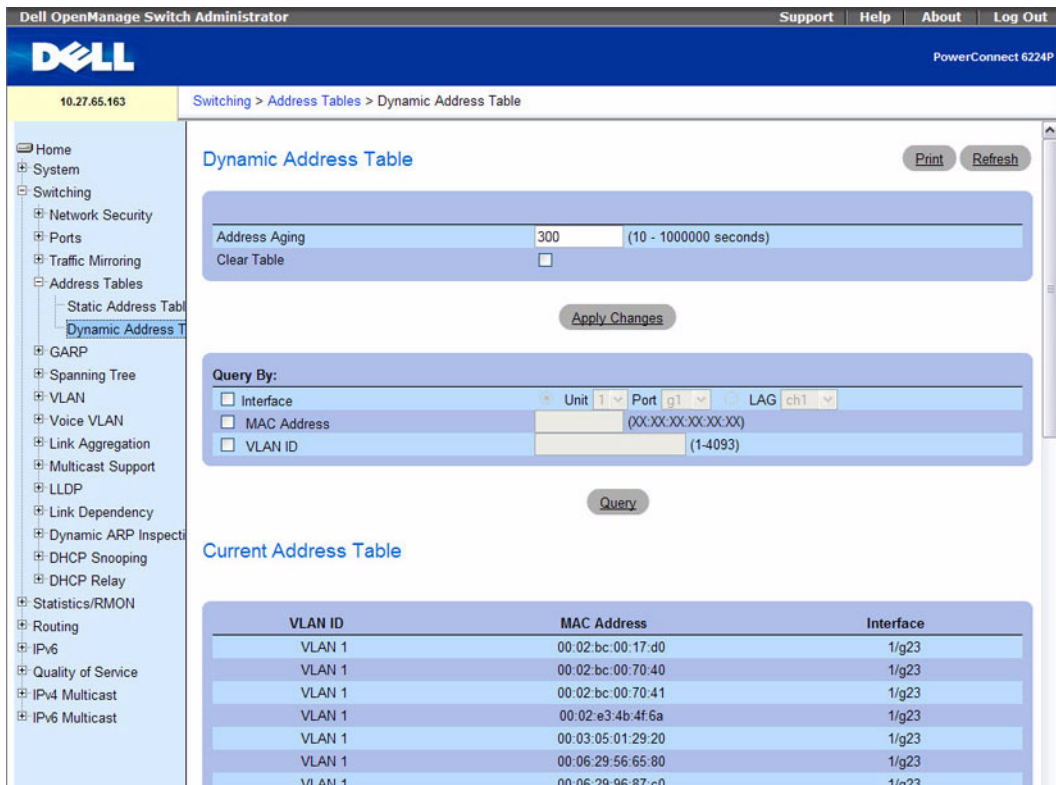

The Dynamic Address Table contains the following fields:

- **Address Aging (10–1000000)** — Specifies aging time in seconds before a dynamic MAC address is erased. The default value is 300 seconds.
- **Clear Table** — Clears all dynamic MAC address data from the table when checked and **Apply Changes** is clicked.
- **The Dynamic Address Table can be queried by:**
 - **Interface** — Specifies Unit and Port queried for an address.
 - **LAG** — Specifies the LAG queried for an address.
 - **MAC Address** — Specifies the MAC address queried for an address.
 - **VLAN ID** — Specifies the VLAN number (to which the MAC address is attached) that is queried for an address.
- **The Current Address Table** contains dynamic address parameters by which packets are directly forwarded to the ports. The **Current Address Table** contains the following fields:

- **VLAN ID** — Displays the VLAN Tag value.
- **MAC Address**— Displays the MAC address.
- **Interface** — Displays the port number.

Defining the Aging Time

1. Open the **Dynamic Address Table** page.
2. Define the **Address Aging** field.
3. Click **Apply Changes**.
The aging time is modified, and the device is updated.

Querying the Dynamic Address Table

1. Open the **Dynamic Address Table** page.
2. Define the parameter by which to query the **Dynamic Address Table**.
Entries can be queried by **Interface**, **LAG**, **MAC Address**, or **VLAN ID**.
3. Click **Query** to query the Dynamic Address Table.

Removing Data From the Dynamic Address Table

1. Open the **Dynamic Address Table** page.
2. Check **Clear Table**.
3. Click **Apply Changes**.
The Dynamic Address Table is cleared of all data.

Querying and Sorting Dynamic Addresses Using CLI Commands

For information about the CLI commands that perform this function, see the following chapter in the *CLI Reference Guide*:

- **Address Table Commands**

The following table summarizes the equivalent CLI commands for this feature.

Table 7-19. Dynamic Address Table Commands

CLI Command	Description
show bridge address-table	Displays dynamically created entries in the bridge forwarding database.
bridge aging-time	Sets the aging time of the address.
clear bridge	Removes any learned entries from the forwarding database.

Configuring GARP

Generic Attribute Registration Protocol (GARP) is a general-purpose protocol that registers any network connectivity or membership-style information. GARP defines a set of switches interested in a given network attribute, such as VLAN or multicast address. The **GARP Timers** page is accessible from the **GARP** menu page.

To display the **GARP** menu page, click **Switching** → **GARP** in the tree view.

GARP Timers

The **GARP Timers** page contains fields for enabling GARP on the switch.

To display the **GARP Timers** page, click **Switching** → **GARP** → **GARP Timers** in the tree view.

Figure 7-36. GARP Timers

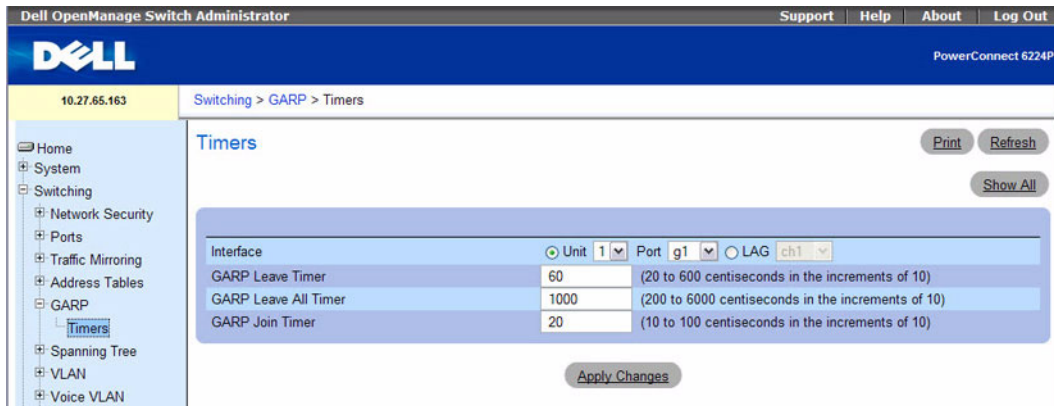

The **GARP Timers** page contains the following fields:

- **Interface** — Specifies the Unit and Port or LAG on which the GARP timer is enabled.
- **GARP Join Timer (10–100)** — Displays time, in centiseconds, that PDUs are transmitted. The possible field value is 10-100. The default value is 100 centiseconds.
- **GARP Leave Timer (30–600)** — Displays time lapse, in centiseconds, that the switch waits before leaving its GARP state. Leave time is activated by a Leave All Time message sent/received, and cancelled by the Join message received. Leave time must be greater than or equal to three times the join time. The possible field value is 30–600. The default value is 60 centiseconds.
- **GARP Leave All Timer (200–6000)** — Displays time lapse, in centiseconds, that all switches wait before leaving the GARP state. The leave all time must be greater than the leave time. The possible field value is 200–6000. The default value is 1000 centiseconds.

Defining GARP Timers

1. Open the GARP Timers page.
2. Complete the fields.
3. Click **Apply Changes**.

The parameters are copied to the selected ports or LAGs in the GARP Timers Table, and the device is updated.

Displaying Parameters in the GARP Timers Table

1. Open the GARP Timers page.
2. Click **Show All**.

The GARP Timers Table displays.

Figure 7-37. GARP Timers Table

GARP Timers Table Print Refresh

Unit: 1

Copy Parameters From: Unit: 1, Port: xg1, LAG: ch1

	Interface	GARP Join Timer	GARP Leave Timer	GARP Leave All Timer	Copy To	Edit
1	1/xg1	20	60	1000	<input type="checkbox"/>	<input type="checkbox"/>
2	1/xg2	20	60	1000	<input type="checkbox"/>	<input type="checkbox"/>
3	1/xg3	20	60	1000	<input type="checkbox"/>	<input type="checkbox"/>

3. Use the **Unit** drop-down menu to view the **GARP Timers Table** for other units in the stack, if they exist.

Copying GARP Timers Settings

1. Open the GARP Timers page.
2. Click **Show All**.
The GARP Timers Table displays.
3. Specify the Unit and Port you are copying from in **Copy Parameters From**.
4. Click **Copy To** for each Interface to receive these parameters.
5. Click **Apply Changes**.

The GARP Timers settings are copied, and the device is updated.

Modifying GARP Timers Settings for Multiple Ports

1. Open the GARP Timers page.
2. Click Show All.
The GARP Timers Table displays.
3. Click Edit for each Interface to modify.
4. Edit the GARP Timers fields as needed.
5. Click Apply Changes.

The GARP Timers settings are modified, and the device is updated.

Defining GARP Timers Using CLI Commands

For information about the CLI commands that perform this function, see the following chapter in the *CLI Reference Guide*:

- GVRP Commands

The following table summarizes the equivalent CLI commands for this feature.

Table 7-20. GARP Timer Commands

CLI Command	Description
garp timer	Adjusts the GARP application join, leave, and leaveall GARP timer values.
show gvrp configuration	Displays GVRP configuration information, including timer values, whether GVRP and dynamic VLAN creation is enabled, and which ports are running GVRP.

Configuring the Spanning Tree Protocol

The Spanning Tree Protocol (STP) provides a tree topology for any arrangement of bridges. STP also provides one path between end stations on a network, eliminating loops. Spanning tree versions supported include Classic STP, Multiple STP, and Rapid STP.

Classic STP provides a single path between end stations, avoiding and eliminating loops. For information on configuring Classic STP, see "STP Global Settings."

Multiple Spanning Tree Protocol (MSTP) supports multiple instances of Spanning Tree to efficiently channel VLAN traffic over different interfaces. Each instance of the Spanning Tree behaves in the manner specified in IEEE 802.1w, Rapid Spanning Tree (RSTP), with slight modifications in the working but not the end effect (chief among the effects, is the rapid transitioning of the port to 'Forwarding'). The difference between the RSTP and the traditional STP (IEEE 802.1d) is the ability to configure and recognize full-duplex connectivity and ports which are connected to end stations, resulting in rapid transitioning of the port to 'Forwarding' state and the suppression of Topology Change Notification. These features are represented by the parameters 'pointtopoint' and 'edgeport'. MSTP is compatible to both RSTP and STP. It behaves appropriately to STP and RSTP bridges. A MSTP bridge can be configured to behave entirely as a RSTP bridge or a STP bridge.

To display the **Spanning Tree** menu page, click **Switching** → **Spanning Tree** in the tree view. This **Spanning Tree** page contains links to the following STP procedures:

- STP Global Settings
- STP Port Settings
- STP LAG Settings
- Rapid Spanning Tree
- MSTP Settings
- MSTP Interface Settings

STP Global Settings

The **STP Global Settings** page contains fields for enabling STP on the switch.

To display the **STP Global Settings** page, click **Switching** → **Spanning Tree** → **Global Settings** in the tree view.

Figure 7-38. Spanning Tree Global Settings

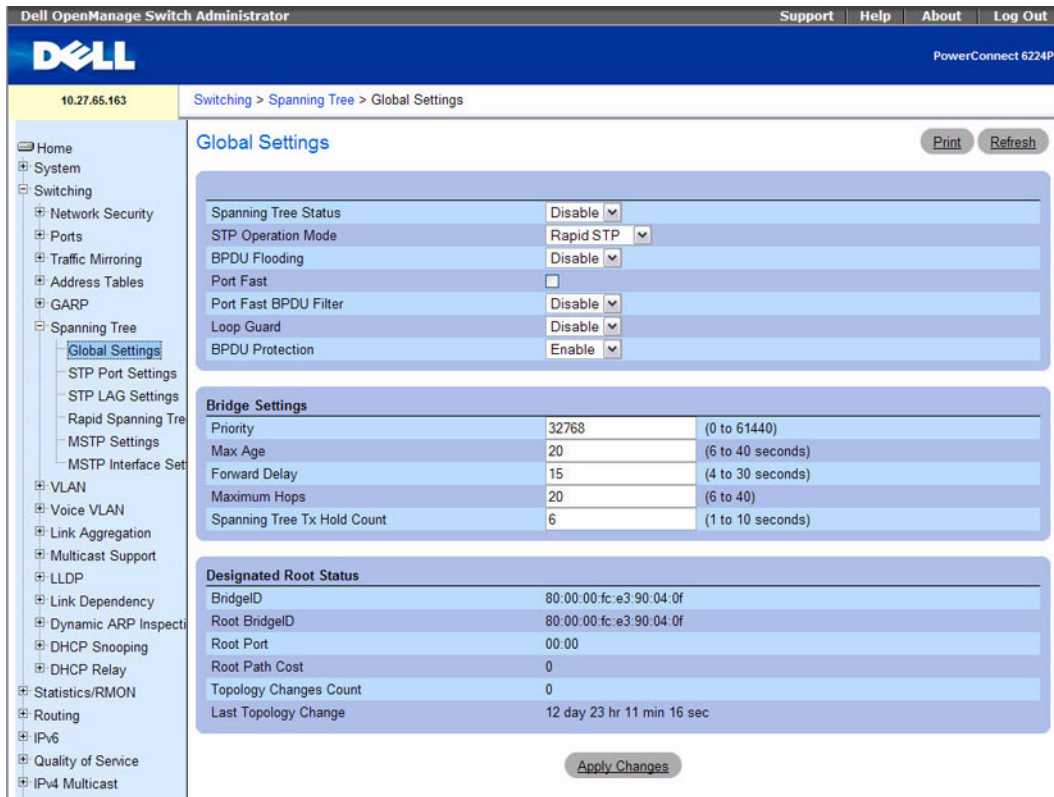

The STP Global Settings page contains the following fields:

- **Spanning Tree Status** — Enables or disables RSTP, STP, or MSTP on the switch.
- **STP Operation Mode** — Specifies the STP mode by which STP is enabled on the switch. Possible field values are: **Classic STP**, **Rapid STP**, and **Multiple STP**.
- **BPDU Flooding** — Specifies Bridge Protocol Data Unit (BPDU) packet handling when the spanning tree is disabled on an interface. The possible field values are **Enable** or **Disable**. The default value is **Disable**.
- **Port Fast** — Enables Port Fast mode for all ports on the switch when checked. If Port Fast mode is enabled for a port, the Port State is automatically placed in the Forwarding state when the port link is up. Port Fast mode optimizes the time it takes for the STP protocol to converge. STP convergence can take 30-60 seconds in large networks.
- **Port Fast BPDU Filter** — Specifies BPDU Filter Mode on all ports which are enabled for Port Fast Mode. Possible values are **Enable** and **Disable**. The default value is **Disable**.
- **Loop Guard** — Enables or disables Loop Guard on all the ports.

- **BPDU Protection** — Disables a port in case a new switch tries to enter the already existing topology of STP. This keeps switches not originally part of an STP from influencing the STP topology.
If set to Enable, when a BPDU is received on an edge port, that port is disabled. Once the port has been disabled it requires manual-intervention to be re-enabled.

Bridge Settings

- **Priority** — Specifies the bridge priority value. When switches or bridges are running STP, each are assigned a priority. After exchanging BPDUs, the switch with the lowest priority value becomes the root bridge. Valid values are from 0–61440. The default value is 32768.
- **Max Age** — Specifies the switch maximum age time, which indicates the amount of time in seconds a bridge waits before implementing a topological change. Valid values are from 6 to 40 seconds. The default value is 20 seconds.
- **Forward Delay** — Specifies the switch forward delay time, which indicates the amount of time in seconds a bridge remains in a listening and learning state before forwarding packets. Valid values are from 4 to 30 seconds. The default value is 15 seconds.
- **Maximum Hops** — Configure the maximum number of hops for the spanning tree. Valid values are from 6 to 40. The default value is 20.
- **Spanning Tree Tx Hold Count** — Configure the Bridge Tx Hold Count parameter for the spanning tree. Valid values are from 1 to 10 seconds. The default value is 6 seconds.

Designated Root Status

- **Bridge ID** — Displays the bridge ID.
- **Root Bridge ID** — Specifies the root bridge ID.
- **Root Port** — Displays port number that offers the lowest-cost path from this bridge to the root bridge. It is significant when the bridge is not the root. The default is zero.
- **Root Path Cost** — Displays the cost of the path from this bridge to the root.
- **Topology Changes Counts** — Displays the total amount of STP state changes that have occurred.
- **Last Topology Change** — Displays the total amount of time since the last topographic change. The time is displayed in day/hour/minute/second format, for example, 5 hours 10 minutes and 4 seconds.

Configuring Spanning Tree Global Settings Using CLI Commands

For information about the CLI commands that perform this function, see the following chapter in the *CLI Reference Guide*:

- Spanning Tree Commands

The following table summarizes the equivalent CLI commands for this feature.

Table 7-21. Spanning Tree Global Commands

CLI Command	Description
spanning-tree	Enables spanning-tree functionality.
spanning-tree bpdu flooding	Allows flooding of BPDUs received on nonspanning-tree ports to all other non-spanning-tree ports.
spanning-tree bpdu-protection	Enables BPDU protection on a switch.
spanning-tree forward-time	Configures the spanning-tree bridge forward time, which is the amount of time a port remains in the listening and learning states before entering the forwarding state.
spanning-tree loopguard	Enables loop guard on all ports.
spanning-tree max-age	Configures the spanning-tree bridge maximum age.
spanning-tree max-hops	Sets the MSTP Max Hops parameter to a new value for the common and internal spanning tree.
spanning-tree mode	Configures the spanning-tree protocol type.
spanning-tree portfast bpdudfilter default	Discards BPDUs received on spanningtree ports in portfast mode.
spanning-tree portfast default	Enables Portfast mode on all ports.
spanning-tree priority	Configures the spanning-tree priority.
spanning-tree transmit hold-count	Set the maximum number of BPDUs that a bridge is allowed to send within a hello time window (2 seconds).
show spanning-tree	Display the spanning-tree configuration.
show spanning-tree summary	Display spanning tree settings and parameters for the switch.

STP Port Settings

Use the STP Port Settings page to assign STP properties to individual ports.

To display the STP Port Settings page, click **Switching** → **Spanning Tree** → **STP Port Settings** in the tree view.

Figure 7-39. STP Port Settings

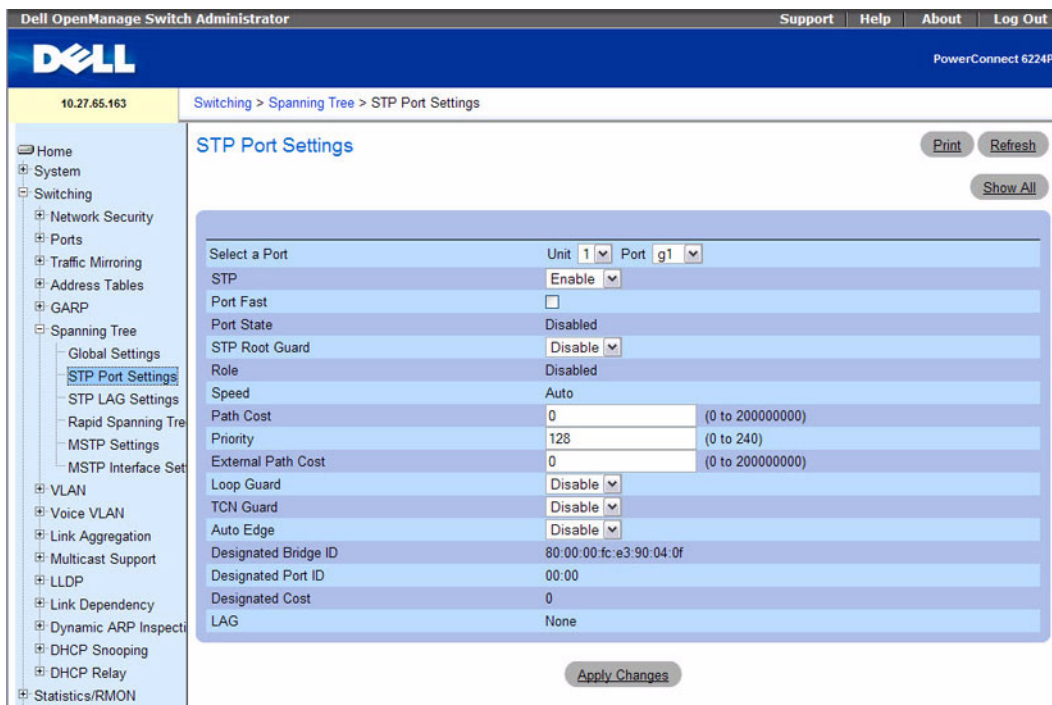

The STP Port Settings page contains the following fields:

- **Select a Port** — Specifies the Unit and Port on which STP is enabled.
- **STP** — Enables or disables STP on the port.
- **Port Fast** — Enables Port Fast mode for the port when checked. If Port Fast mode is enabled for a port, the **Port State** is automatically placed in the **Forwarding** state when the port link is up. STP convergence can take 30–60 seconds in large networks.
- **Port State**—Indicates the current STP state of a port. If enabled, the port state determines what forwarding action is taken on traffic. Possible port states are:
 - **Disabled** — STP is currently disabled on the port. The port forwards traffic while learning MAC addresses.

- **Blocking** — The port is currently blocked and cannot be used to forward traffic or learn MAC addresses.
- **Listening** — The port is currently in the listening mode. The port cannot forward traffic nor can it learn MAC addresses.
- **Learning** — The port is currently in the learning mode. The port cannot forward traffic, however, it can learn new MAC addresses.
- **Forwarding** — The port is currently in the forwarding mode. The port can forward traffic and learn new MAC addresses.
- **STP Root Guard** — Prevents the root of a Spanning Tree instance from changing unexpectedly. When a root bridge has root guard enabled and a superior BPDU arrives, that port is moved to a root-inconsistent state, which equates to the listening state. The root bridge is enforced.
- **Role** — Displays the role this port has in the STP topology. The port role will be one of the following values: Root Port, Designated Port, Alternate Port, Backup Port, Master Port or Disabled Port.
- **Speed** — Displays speed at which the port is operating.
- **Path Cost** — Specifies the port contribution to the root path cost. The path cost is adjusted to a higher or lower value, and is used to forward traffic when a path is being rerouted. A value of zero means the path cost is set according to the port's speed. The possible values are 0 to 200000000. The default value is 0.
- **Priority** — Specifies priority value of the port. The priority value influences the port choice when a bridge has two ports connected in a loop. The possible values are 0 to 240. The default value is 128.
- **External Path Cost** — Specifies the External Path Cost to a new value for the specified port in the spanning tree. Enter 0 to set the external path cost value automatically on the basis of Link Speed. The possible values are 0 to 200000000. The default value is 0.
- **Loop Guard** — Prevents a port from erroneously transitioning from blocking state to forwarding when the port stops receiving BPDUs. The port is marked as being in loop-inconsistent state. In this state, the port does not forward packets. The possible values are **Enable** or **Disable**.
- **TCN Guard** — Enabling the TCN Guard feature restricts the port from propagating any topology change information received through that port. This means that even if a port receives a BPDU with the topology change flag set to true, the port will not flush its MAC address table and send out a BPDU with a topology change flag set to true.
- **Auto Edge** — Enabling the Auto Edge feature allows the port to become an edge port if it does not see BPDUs for some duration.
- **Designated Bridge ID** — Displays the ID of the designated bridge.
- **Designated Port ID** — Displays the ID of the selected port.
- **Designated Cost** — Displays cost of the port participating in the STP topology. Ports with a lower cost are less likely to be blocked if STP detects loops.
- **LAG** — Displays LAG to which the port is attached.

Displaying the STP Port Table and Configuring STP Port Settings

1. Open the STP Port Settings page.
2. Click Show All.

The STP Port Table displays.

Figure 7-40. STP Port Table

Port	STP	Port Fast	STP Root Guard	State	Role	Path Cost	Priority	External Path Cost	Loop Guard	TCN Guard	Auto Edge	Designated Bridge
1 1/g1	Enable	<input type="checkbox"/>	Disable	Forwarding	Root	200000	128	200000	Disable	Disable	Disable	82:34:00:16:9c:e1:d
2 1/g2	Enable	<input type="checkbox"/>	Disable	Disabled	Disabled	0	128	0	Disable	Disable	Disable	80:00:00:ff:f2:a3:88
3 1/g3	Enable	<input type="checkbox"/>	Disable	Disabled	Disabled	0	128	0	Disable	Disable	Disable	80:00:00:ff:f2:a3:88

3. Use the **Unit** drop-down menu to view the **STP Port Table** for other units in the stack, if they exist.
4. To change the STP settings for one or more ports, select the Edit option for the port(s), configure the desired settings, and then click **Apply Changes**.

Configuring Spanning Tree Port Settings Using CLI Commands

For information about the CLI commands that perform this function, see the following chapter in the *CLI Reference Guide*:

- Spanning Tree Commands

The following table summarizes the equivalent CLI commands for this feature.

Table 7-22. Spanning Tree Port Commands

CLI Command	Description
spanning-tree cost	Configures the spanning-tree path cost for a port.
spanning-tree disable	Disables spanningtree on a specific port.
spanning-tree guard	Selects whether loop guard or root guard is enabled on an interface.
spanning-tree auto-portfast	Sets the port to auto portfast mode.
spanning-tree portfast	Enables spanning-tree portfast mode
spanning-tree port-priority	Configures port priority.
spanning-tree tenguard	Prevent a port from propagating topology change notifications.

STP LAG Settings

Use the STP LAG Settings page to assign STP aggregating ports parameters.

To display the STP LAG Settings page, click **Switching** → **Spanning Tree** → **STP LAG Settings** in the tree view.

Figure 7-41. STP LAG Settings

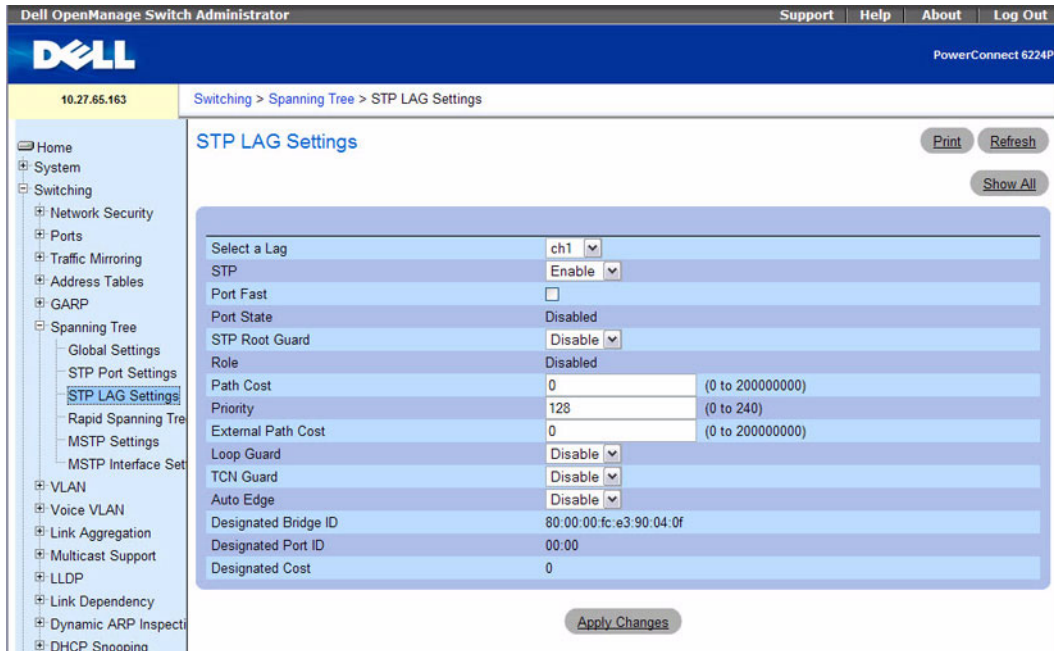

The **STP LAG Settings** page contains the following fields:

- **Select a LAG** — Specifies the LAG number for which you want to modify STP settings.
- **STP** — Enables or disables STP on the LAG. Default is enable.
- **Port Fast** — Enables Port Fast mode for the LAG. If Port Fast mode is enabled for a LAG, the **Port State** is automatically placed in the **Forwarding** state when the LAG is up. Port Fast mode optimizes the time it takes for the STP protocol to converge. STP convergence can take 30–60 seconds in large networks.
- **Port State** — Displays current STP state of a LAG. If enabled, the LAG state determines what forwarding action is taken on traffic. If the bridge discovers a malfunctioning LAG, the LAG is placed in the **Broken** state. Possible LAG states are:
 - **Disabled** — STP is currently disabled on the LAG. The LAG forwards traffic while learning MAC addresses.
 - **Blocking** — The LAG is blocked and cannot be used to forward traffic or learn MAC addresses.
 - **Listening** — The LAG is in the listening mode and cannot forward traffic or learn MAC addresses.

- **Learning** — The LAG is in the learning mode and cannot forward traffic, but it can learn new MAC addresses.
- **Forwarding** — The LAG is currently in the forwarding mode, and it can forward traffic and learn new MAC addresses.
- **Broken** — The LAG is currently malfunctioning and cannot be used for forwarding traffic.
- **STP Root Guard** — Enables or disables STP Root Guard. The default is disable.
- **Role** — Displays the role this port has in the STP topology.
- **Path Cost** — Specifies amount the LAG contributes to the root path cost. The path cost is adjusted to a higher or lower value, and is used to forward traffic when a path is being rerouted. The range is 0–200000000. The default is 0.
- **Priority** — Specifies priority value of the LAG. The priority value influences the LAG choice when a bridge has two looped ports. The priority value is between 0–240. The default value is 128.
- **External Path Cost** — Specifies the External Path Cost to a new value for the specified port in the spanning tree. Enter 0 to set the external path cost value automatically on the basis of Link Speed. The default value is 0.
- **Loop Guard** — Prevents a LAG from erroneously transitioning from blocking state to forwarding when the LAG stops receiving BPDUs. The LAG is marked as being in loop-inconsistent state. In this state, the LAG does not forward packets. The possible values are Enable or Disable.
- **TCN Guard** — Enabling the TCN Guard feature restricts the LAG from propagating any topology change information received through that LAG. This means that even if a LAG receives a BPDU with the topology change flag set to true, the port will not flush its MAC address table and send out a BPDU with a topology change flag set to true.
- **Auto Edge** — Enabling the Auto Edge feature allows the LAG to become an edge port if it does not see BPDUs for some duration.
- **Designated Bridge ID** — Displays designated bridge ID.
- **Designated Port ID** — Displays designated port ID.
- **Designated Cost** — Displays cost of the port participating in the STP topology. Ports with a lower cost are less likely to be blocked if STP detects loops.

Displaying the STP LAG Table and Configuring STP LAG Settings

1. Open the STP LAG Settings page.
2. Click Show All.

The STP LAG Table displays.

Figure 7-42. STP LAG Table

STP LAG Table

Port	STP	Port Fast	STP Root Guard	State	Role	Path Cost	Priority	External Path Cost	Loop Guard	TCN Guard	Auto Edge	Designated Bridge ID
ch1	Enable	<input type="checkbox"/>	Disable	Disabled	Disabled	0	128	0	Disable	Disable	Disable	80.00.00.#f2.a3.88.88
ch2	Enable	<input type="checkbox"/>	Disable	Disabled	Disabled	0	128	0	Disable	Disable	Disable	80.00.00.#f2.a3.88.88
ch3	Enable	<input type="checkbox"/>	Disable	Disabled	Disabled	0	128	0	Disable	Disable	Disable	80.00.00.#f2.a3.88.88

- To change the STP settings for one or more LAGs, select the Edit option for the LAG(s), configure the desired settings, and then click **Apply Changes**.

Defining STP LAG Settings Using CLI Commands

See "Configuring Spanning Tree Port Settings Using CLI Commands" on page 350.

Rapid Spanning Tree

Rapid Spanning Tree Protocol (RSTP) detects and uses network topologies that allow a faster convergence of the spanning tree without creating forwarding loops.

To display the Rapid Spanning Tree page, click **Switching** → **Spanning Tree** → **Rapid Spanning Tree** in the tree view.

Figure 7-43. Rapid Spanning Tree



The **Rapid Spanning Tree** page contains the following fields:

- Interface** — Determines if RSTP is enabled on a Unit/Port or on a LAG. Click Unit/Port or LAG to specify the type of interface, then select the Unit/Port or LAG to configure from the drop-down menu.
- State** — Displays the spanning tree state for the port.
- Role** — Displays the spanning tree role for the port in the STP topology.

- **Mode** — Displays the administrative mode and if its enabled or disabled.
- **Fast Link Operational Status** — Indicates if Fast Link is enabled or disabled for the port or LAG. If Fast Link is enabled for a port, the port is automatically placed in the forwarding state. This setting can be changed from the "STP Port Settings" or "STP LAG Settings" page.
- **Point to Point Operational Status** — Displays the Point-to-Point operating state.

To establish communications over a point-to-point link, the originating PPP first sends Link Control Protocol (LCP) packets to configure and test the data link. After a link is established and optional facilities are negotiated as needed by the LCP, the originating PPP sends Network Control Protocols (NCP) packets to select and configure one or more network layer protocols. When each of the chosen network layer protocols has been configured, packets from each network layer protocol can be sent over the link. The link remains configured for communications until explicit LCP or NCP packets close the link, or until some external event occurs. This is the actual switch port link type.

Displaying the Rapid Spanning Tree (RSTP) Table

1. Open the Rapid Spanning Tree (RSTP) page.
2. Click Show All.

The Rapid Spanning Tree Table displays.

Figure 7-44. Rapid Spanning Tree Table

Interface	Role	Fast Link Operational Status	Point to Point Operational Status
1 1/xg1	Designated	Disabled	Enable
2 1/xg2	Disabled	Disabled	Disable
3 1/xg3	Designated	Disabled	Enable

3. Use the Unit drop-down menu to view the Rapid Spanning Tree Table for other units in the stack, if they exist.

Configuring RSTP Ports Using CLI Commands

See "Configuring Spanning Tree Port Settings Using CLI Commands" on page 350.

MSTP Settings

The Multiple Spanning Tree Protocol (MSTP) supports multiple instances of Spanning Tree to efficiently channel VLAN traffic over different interfaces. MSTP is compatible with both RSTP and STP; a MSTP bridge can be configured to behave entirely as a RSTP bridge or a STP bridge.

To display the MSTP Settings page, click **Switching** → **Spanning Tree** → **MSTP Settings** in the tree view.

Figure 7-45. MSTP Settings

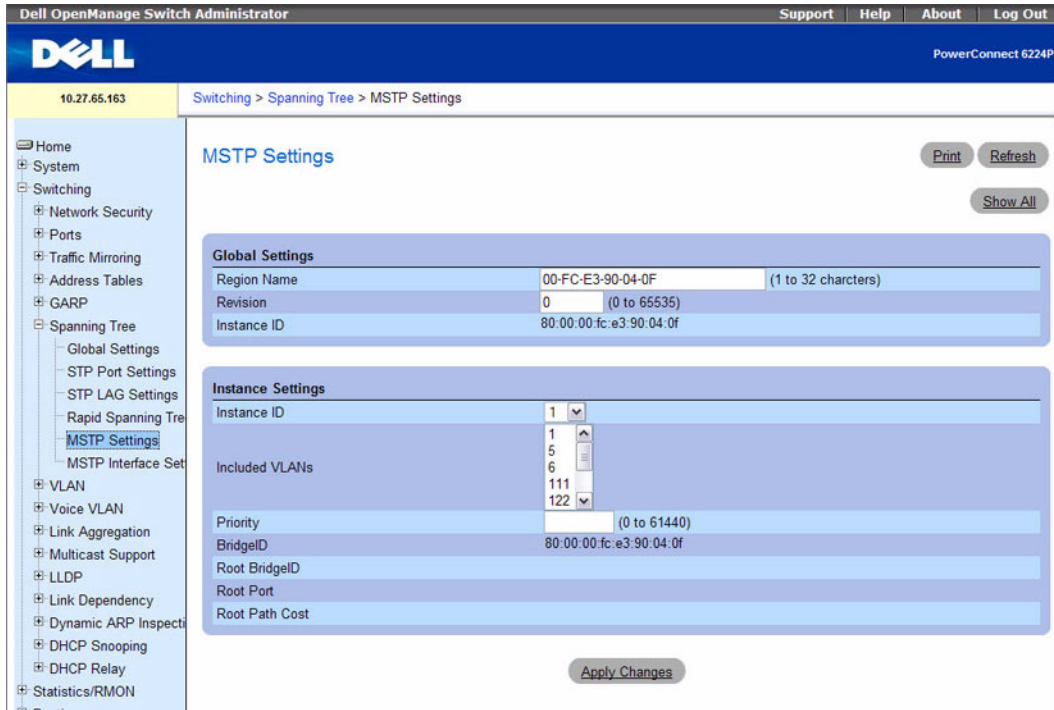

The MSTP Settings page contains the following fields divided into two sections, **Global Settings** and **Instance Settings**:

- **Region Name (1–32 characters)** — Specifies a user-defined MST region name.
- **Revision (0–65535)** — Specifies unsigned 16-bit number that identifies the revision of the current MST configuration. The revision number is required as part of the MST configuration. Default is 0.
- **Max Hops (1–40)** — Specifies the total number of hops that occur in a specific region before the BPDU is discarded. Once the BPDU is discarded, the port information is aged out. Default is 20.
- **Instance ID** — Specifies the ID of the spanning tree instance. The field range is 1–15, and default is 1.
- **Included VLANs** — Maps the selected VLANs to the selected instance. Every VLAN belongs to one instance only.
- **Priority (0–61440)** — Specifies the switch priority for the selected spanning tree instance. The default value is 32768.
- **Bridge ID** — Indicates the bridge ID of the selected instance.

- **Root Bridge ID** of the root bridge which is the one with the lowest path cost.
- **Root Port** — Indicates the root port of the selected instance.
- **Root Path Cost** — Indicates the path cost of the selected instance.

Modifying MSTP Settings:

1. Open the **MSTP Settings** page.
2. Modify the fields in the **Global Settings** and **Instance Settings** sections as needed.
3. Click **Apply Changes**.

The MSTP parameters are modified, and the device is updated.

Displaying the MSTP VLAN to Instance Mapping Table

1. Open the **MSTP Settings** page.
2. Click **Show All**.

The **MSTP Settings Table** displays.

Figure 7-46. MSTP Settings Table

	VLAN	Instance ID (0-15)	Edit
1	1	0	<input type="checkbox"/>
2	3	0	<input type="checkbox"/>
3	5	0	<input type="checkbox"/>
4	7	0	<input type="checkbox"/>
5	888	0	<input type="checkbox"/>
6	2222	0	<input type="checkbox"/>

3. To modify the Instance ID for one or more VLANs, check **Edit** for the desired VLANs.
4. Make needed changes to Instance IDs. Enter a value of 0 to remove the VLAN-to-Instance mapping.
5. Click **Apply Changes**.

The Instance IDs are modified for the selected VLANs, and the device is updated.

Defining MST Instances Using CLI Commands

For information about the CLI commands that perform this function, see the following chapter in the *CLI Reference Guide*:

- **Spanning Tree Commands**

The following table summarizes the equivalent CLI commands for this feature.

Table 7-23. MST

CLI Command	Description
instance	Maps VLANs to an MST instance.
name	Define the configuration name for an MST instance.
revision	Identifies the configuration revision number of an MST instance.
spanning-tree max-hops	Sets the MSTP Max Hops parameter to a new value for the common and internal spanning tree.
spanning-tree mst configuration	Enables configuring an MST region by entering the multiple spanning-tree (MST) mode.
spanning-tree mst priority	Sets the switch priority for the specified spanning-tree instance.

MSTP Interface Settings

Use the MSTP Interface Settings page to assign MSTP settings to specific interfaces.

To display the MSTP Interface Settings page, click **Switching** → **Spanning Tree** → **MSTP Interface Settings** in the tree view.

Figure 7-47. MSTP Interface Settings

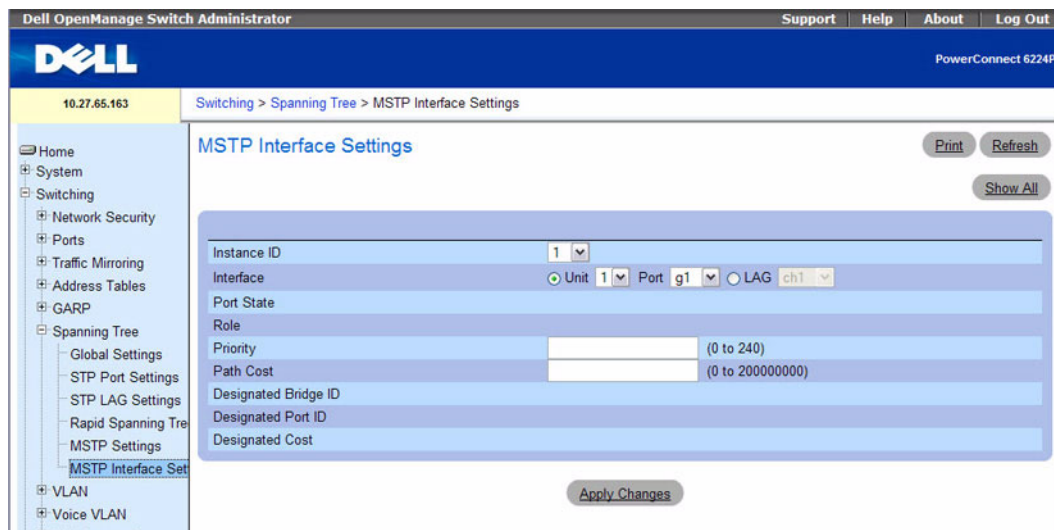

The MSTP Interface Settings page contains the following fields:

- **Instance ID** — Selects the MSTP instances configured on the switch. Possible field range is 1–15.
- **Interface** — Selects either a Unit/Port or LAG for this MSTP instance.

- **Port State** — Indicates whether the port is enabled or disabled in the specific instance.
- **Port Type** — Indicates whether MSTP treats the port as a point-to-point port or a port connected to a hub and whether the port is internal to the MST region or a boundary port. If the port is a boundary port, it also indicates whether the switch on the other side of the link is working in RSTP or STP mode
- **Role** — Indicates the port role assigned by the STP algorithm in order to provide to STP paths. The possible field values are:
 - **Root** — Provides the lowest cost path to forward packets to root switch.
 - **Designated** — Indicates the port or LAG through which the designated switch is attached to the LAN.
 - **Alternate** — Provides an alternate path to the root switch from the interface.
 - **Backup** — Provides a backup path to the designated LAN. Backup ports occur only when two ports are connected in a loop by a point-to-point link. Backup ports also occur when a LAN has two or more connections connected to a shared segment.
 - **Disabled** — Indicates the port is not participating in the Spanning Tree.
- **Priority** — Defines the interface priority for the specified instance. The priority range is 0–240 in steps of 16. The default value is 128.
- **Path Cost (0–200000000)** — Indicates the port contribution to the Spanning Tree instance. The range should always be 0–200,000,000. The default value is determined by the port’s speed. The default value is:
 - Port Channel-20,000
 - 1000 mbps (giga)-20,000
 - 100 mbps-200,000
 - 10 mbps-2,000,000
- **Designated Bridge ID** — Displays the bridge ID number that connects the link or shared LAN to the root.
- **Designated Port ID** — Displays the port ID number on the designated bridge that connects the link or the shared LAN to the root.
- **Designated Cost** — Displays cost of the path from the link or the shared LAN to the root.

Assigning MSTP Interface Settings

1. Open the **MSTP Interface Settings** page.
2. Select an **Instance ID** from the drop-down menu.
3. Specify **Port** or **LAG**, then select the interface from the related drop-down menu.
4. Specify **Interface Priority** and **Path Cost**.
5. Click **Apply Changes**.

The interface settings are saved, and the device is updated.

Displaying the MSTP Interface Settings Table

1. Open the MSTP Settings page.
2. Click Show All.

The MSTP Interface Table displays.

Figure 7-48. MSTP Interface Table

Interface	Role	Port Priority	Path Cost	Port State	Designated Cost	Designated Bridge ID	Designated Port ID	Edit
1 1/xg1	Enabled	128	0	Enabled	0	80:01:00:FC:E3:90:01:45	8001	<input type="checkbox"/>
2 1/xg2	Enabled	128	0	Enabled	0	80:01:00:FC:E3:90:01:45	8002	<input type="checkbox"/>
3 1/xg3	Enabled	128	0	Enabled	0	80:01:00:FC:E3:90:01:45	8003	<input type="checkbox"/>

3. Use the **Unit** drop-down menu to view the **MSTP Interface Table** for other units in the stack, if they exist.
4. To modify the port priority or path cost for one or more interfaces, check **Edit** for the desired interfaces.
5. Make the needed changes to the values in the **Port Priority** or **Path Cost** columns.
6. Click Apply Changes.

The fields are modified for the selected Interfaces, and the device is updated.

Defining MSTP Interfaces Using CLI Commands

For information about the CLI commands that perform this function, see the following chapter in the *CLI Reference Guide*:

- Spanning Tree Commands

Configuring MST Port Settings Using CLI Commands

For information about the CLI commands that perform this function, see the following chapter in the *CLI Reference Guide*:

- Spanning Tree Commands

The following table summarizes the equivalent CLI commands for this feature.

Table 7-24. MST Port Commands

CLI Command	Description
spanning-tree mst 0 external-cost	Sets the external cost for the common spanning tree.
spanning-tree mst cost	Configure the path cost for multiple spanning tree (MST) calculations.
spanning-tree mst port-priority	Configures port priority.

Configuring VLANs

Adding Virtual LAN (VLAN) support to a Layer 2 switch offers some of the benefits of both bridging and routing. Like a bridge, a VLAN switch forwards traffic based on the Layer 2 header, which is fast, and like a router, it partitions the network into logical segments, which provides better administration, security and management of multicast traffic.

A VLAN is a set of end stations and the switch ports that connect them. You may have many reasons for the logical division, such as department or project membership. The only physical requirement is that the end station and the port to which it is connected both belong to the same VLAN.

Each VLAN in a network has an associated VLAN ID, which appears in the IEEE 802.1Q tag in the Layer 2 header of packets transmitted on a VLAN. An end station may omit the tag, or the VLAN portion of the tag, in which case the first switch port to receive the packet may either reject it or insert a tag using its default VLAN ID. A given port may handle traffic for more than one VLAN, but it can only support one default VLAN ID.

To display the **VLAN** menu page, click **Switching** → **VLAN** in the tree view. This **VLAN** page contains links to the following features:

- VLAN Membership
- Double VLAN
- VLAN Port Settings
- VLAN LAG Settings
- Bind MAC to VLAN
- Bind IP Subnet to VLAN
- Protocol Group
- GVRP Parameters

VLAN Membership

Use the **VLAN Membership** page to define VLAN groups stored in the VLAN membership table. Your switch supports up to 4094 VLANs. However, you can actually create only 4092 VLANs because:

- VLAN 1 is the default VLAN of which all ports are members, and
- VLAN 4095 is designated as the "Discard VLAN."

Valid VLANs that can be created are 2–4093. VLAN 4094 is reserved.

To display the **VLAN Membership** page, click **Switching** → **VLAN** → **VLAN Membership** in the tree view.

Figure 7-49. VLAN Membership

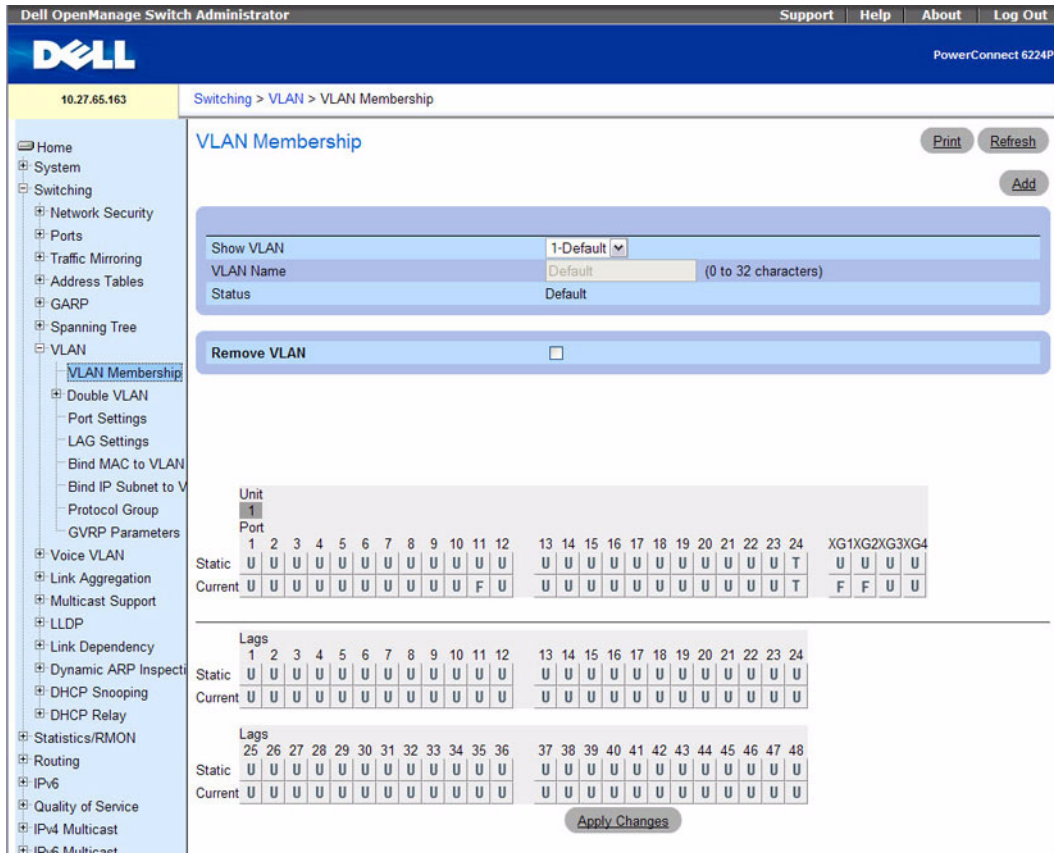

The **VLAN Membership** page is divided into two sections. The top section contains fields that define the entire VLAN’s membership. The bottom section contains tables that define membership settings for specific Ports and LAGs on this VLAN. Following are the **VLAN Membership** fields:

- **Show VLAN** — Selects the VLAN to display. Use either the **VLAN ID** or **VLAN Name** drop-down menu to select the VLAN.
- **VLAN Name (0–32)** — Indicates the user-defined VLAN name. This field is defined using the **Add** button. Valid names can range from 0–32 characters in length.
- **Status**—Indicates the VLAN type. Possible values are:

- **Dynamic** — Indicates the VLAN was dynamically created through GVRP.
- **Static** — Indicates the VLAN is user-defined and may be modified.
- **Default** — Indicates the VLAN is the default VLAN.
- **Remove VLAN** — Removes the displayed VLAN from the VLAN Membership Table when checked.

The **VLAN Membership** tables display which Ports and LAGs are members of the VLAN, and whether they're tagged (T), untagged (U), or forbidden (F). The tables have two rows: **Static** and **Current**. Only the **Static** row is accessible from this page. The **Current** row is updated either dynamically through GVRP or when the **Static** row is changed and **Apply Changes** is clicked.

There are two tables in this section of the page:

- **Ports** — Displays and assigns VLAN membership to ports. To assign membership, click in **Static** for a specific port. Each click toggles between U, T, and blank. See the following table for definitions.
- **LAGs** — Displays and assigns VLAN membership to LAGs. To assign membership, click in **Static** for a specific LAG. Each click toggles between U, T, and blank. See the following table for definitions.

Table 7-25. VLAN Port Membership Definitions

Port Control	Definition
T	Tagged: the interface is a member of a VLAN. All packets forwarded by the interface are tagged. The packets contain VLAN information.
U	Untagged: the interface is a VLAN member. Packets forwarded by the interface are untagged.
F	Forbidden: indicates that the interface is forbidden from becoming a member of the VLAN.
Blank	Blank: the interface is not a VLAN member. Packets associated with the interface are not forwarded.

Adding New VLANs

1. Open the **VLAN Membership** page.
2. Click **Add**.

The **Add VLAN** page displays.

Figure 7-50. Add VLAN

The screenshot shows a web interface for adding a VLAN. At the top left is the title 'Add VLAN'. In the top right corner, there are two buttons: 'Print' and 'Refresh'. The main content area is a light blue box containing two input fields. The first field is labeled 'VLAN ID (2 - 4093)' and the second is labeled 'VLAN Name (0-32 characters)'. Below these fields, there are two buttons: 'Apply Changes' and 'Back'.

3. Enter a new VLAN ID and VLAN Name.
4. Click **Apply Changes**.
The new VLAN is added, and the device is updated.

Assigning VLAN Membership to a Port or LAG

1. Open the **VLAN Membership** page.
2. Select a VLAN from the **VLAN ID** or **VLAN Name** drop-down menu.
3. In the **VLAN Port Membership Table**, assign a value by clicking in the **Static** row for a specific Port/LAG. Each click toggles between U, T, and blank (not a member).
4. Click **Apply Changes**.
The Port or LAG is assigned to the VLAN with the selected designation, the **Current** row is updated with the designation, and the device is updated.

Modifying VLAN Membership Groups

1. Open the **VLAN Membership** page.
2. Select a VLAN from the **VLANID** or **VLAN Name** drop-down menu.
3. Modify the fields as needed.
4. In the **VLAN Port Membership Table**, change a Port or LAG value by clicking in the **Static** row for that Port/LAG. Each click toggles between U, T, and blank (not a member).
5. Click **Apply Changes**.
The VLAN membership information is modified, the **Current** row is updated with any changes in designation, and the device is updated.

Removing a VLAN

1. Open the **VLAN Membership** page.
2. Select a VLAN from the **VLAN ID** or **VLAN Name** drop-down menu.
3. Check the **Remove VLAN** check box.
4. Click **Apply Changes**.

The selected VLAN is removed, and the device is updated.

Configuring VLAN Membership Using CLI Commands

For information about the CLI commands that perform this function, see the following chapter in the *CLI Reference Guide*:

- Virtual LAN Routing Commands

The following table summarizes the equivalent CLI commands for this feature.

Table 7-26. VLAN Membership Commands

CLI Command	Description
name	Configures a name to a VLAN.
show interfaces switchport	Displays switchport configuration.
show vlan	Displays VLAN information.
switchport forbidden vlan	Forbids adding specific VLANs to a port.
switchport general allowed vlan	Adds or removes VLANs from a port in General mode.
switchport trunk allowed vlan	Adds or removes VLANs from a port in general mode.
vlan	Creates a VLAN.
vlan database	Enters the VLAN database configuration mode.
vlan makestatic	Changes a dynamically created VLAN to a static VLAN.

Double VLAN

The Double VLAN feature allows the use of a second tag on network traffic. The additional tag helps differentiate between customers in the Metropolitan Area Networks (MAN) while preserving individual customer's VLAN identification when they enter their own 802.1Q domain.

With the introduction of this second tag, you do not need to divide the 4k VLAN ID space to send traffic on an Ethernet-based MAN.

With Double VLAN Tunneling enabled, every frame that is transmitted from an interface has a DVLAN Tag attached while every packet that is received from an interface has a tag removed (if one or more tags are present).

Use the **Double VLAN Global Configuration** page to specify the Double VLAN configuration for all the ports.

To access the **Double VLAN Global Configuration** page, click **Switching** → **VLAN** → **Double VLAN** → **Global Configuration** from the navigation tree.

Figure 7-51. Double VLAN Global Configuration

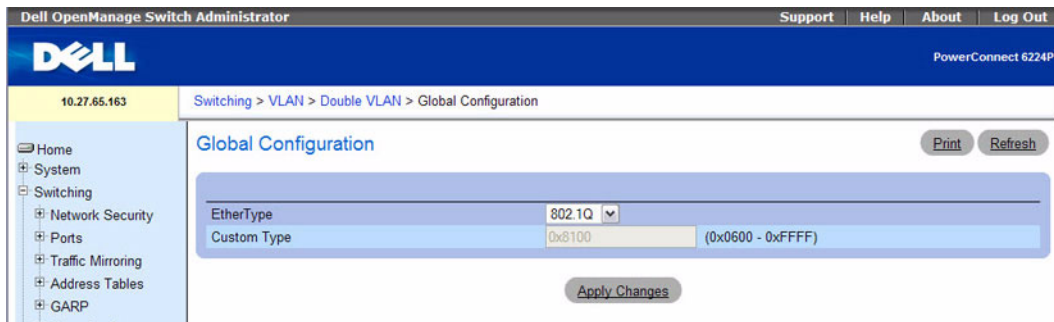

The Double VLAN Global Configuration page contains the following fields:

- **EtherType** — The two-byte hex Ethertype to be used as the first 16 bits of the Double VLAN tag:
 - **802.1Q** — Commonly used tag representing 0x8100. This value is supported by several network equipment manufacturers. If a double-tagged frame with the first Ethertype value set to 802.1Q is forwarded to hardware which does not support Double VLAN (or the corresponding configuration is not set), it will be misinterpreted as a regular, single-tagged frame.
 - **vMAN** — Commonly used tag representing 0x88A8, defined for the Virtual Metropolitan Area Network. This value is often used to indicate double-tagged frames. If a double-tagged frame with an Ethertype value set to vMAN is forwarded to hardware without Double VLAN support (or when Double VLAN is not configured), it will be dropped due to unknown Ethertype. This outcome may be more efficient, and cause less harm than when the 802.1Q Ethertype value is used for double-tagged frames. When presented with a double-tagged frame with an 802.1Q Ethertype value, the switch that does not support double-tagging may attempt to process the double-tagged frame with the incorrect assumption that frame contains only a single VLAN tag.
 - **Custom** — Use this to specify that double-tagged frames will use a custom Ethertype. A custom Ethertype may be used to make the switch interoperable with specific or non-standard equipment that does not support 802.1 or vMAN values of Ethertype in double-tagged frames. For more information, refer to the list of registered Ethertype values for common protocols.
- **Custom Type** — If Custom is selected in the Ethertype field, enter a custom Ethertype value in any range from 0 to 65535.

Use the **Double VLAN Interface Configuration** page to enable or disable Double VLAN mode on a physical port or LAG.

To access the **Double VLAN Interface Configuration** page, click **Switching** → **VLAN** → **Double VLAN Interface Configuration** from the navigation tree.

Figure 7-52. Double VLAN Interface Configuration

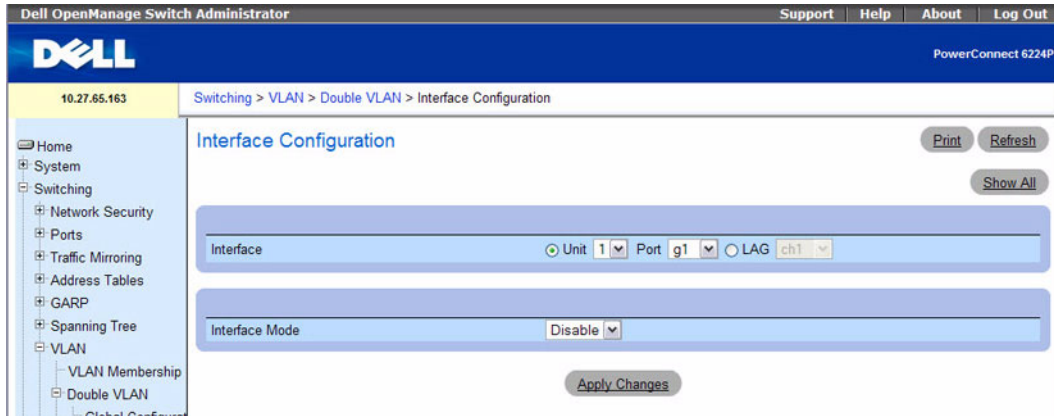

The **Double VLAN Interface Configuration** page contains the following fields:

- **Interface** — Select the port or LAG for which you want to display or configure data.
- **Interface Mode** — Enables or disables double VLAN tagging on the selected interface. The default value is **Disable**.

Assigning Double VLAN Tags

1. Open the **Double VLAN Global Configuration** page.
2. Select the **Ethertype** from the drop-down menu.
3. Click **Apply Changes**.
4. Open the **Double VLAN Interface Configuration** page.
5. Select the port to which you want to assign settings from the **Interface** drop-down menu.
6. Select the **Interface Mode** from the drop-down menu.
7. Click **Apply Changes**.

The Double VLAN settings are defined, and the device is updated.

Displaying the Double VLAN Port Parameters Table

1. Open the **Double VLAN Interface Configuration** page.
2. Click **Show All**.

The **Double VLAN Port Parameters Table** displays.

Figure 7-53. Double VLAN Port Parameters Table

Interface	Interface Mode	Ether Type	Custom Type (0-65535)	Copy To	Edit
1	1/xg1	Disable	802.1Q	0	<input type="checkbox"/>
2	1/xg2	Disable	802.1Q	0	<input type="checkbox"/>
3	1/xg3	Disable	802.1Q	0	<input type="checkbox"/>
4	1/xg4	Disable	802.1Q	0	<input type="checkbox"/>
5	1/xg5	Disable	802.1Q	0	<input type="checkbox"/>
6	1/xg6	Disable	802.1Q	0	<input type="checkbox"/>
7	1/xg7	Enable	802.1Q	0	<input type="checkbox"/>
8	1/xg8	Disable	802.1Q	0	<input type="checkbox"/>

Copying Double VLAN Parameters

1. Open the Double VLAN Interface Configuration page.
2. Click Show All.
The Double VLAN Port Parameters Table displays.
3. Specify the Port you are copying from in Copy Parameters From.
4. Click Copy To for each Interface to receive these parameters.
5. Click Apply Changes.
The Double VLAN port settings are copied, and the device is updated.

Modifying Settings for Multiple Ports

1. Open the Double VLAN Interface Configuration page.
2. Click Show All.
The Double VLAN Port Parameters Table displays.
3. Click Edit for each Port to modify.
4. Edit fields as needed.
5. Click Apply Changes.
The Double VLAN port settings are modified, and the device is updated.

Configuring Double VLAN Tagging Using CLI Commands

For information about the CLI commands that perform this function, see the following chapter in the *CLI Reference Guide*:

- VLAN Commands

The following table summarizes the equivalent CLI commands for this feature.

Table 7-27. Double VLAN Commands

CLI Command	Description
dvlan-tunnel ethertype	Configures the EtherType for the interface.
mode dvlan-tunnel	Enables Double VLAN tunneling on the specified interface
show dvlan-tunnel	Displays all interfaces enabled for Double VLAN Tunneling.
show dvlan-tunnel interface	Displays detailed information about Double VLAN Tunneling for the specified interface.

VLAN Port Settings

In a port-based VLAN, untagged traffic is bridged through specified ports based on the receiving ports PVID. Port-based VLANs can help optimize network traffic patterns because broadcast, multicast, and unknown unicast packets are sent only to ports that are members of the VLAN. Packets that are received with a VLAN tag uses that VLAN ID for the switching process.

Use the **VLAN Port Settings** page to identify a port as part of a VLAN, as well as to define and modify VLAN port parameters.

To display the **VLAN Port Settings** page, click **Switching** → **VLAN** → **Port Settings** in the tree view.

Figure 7-54. VLAN Port Settings

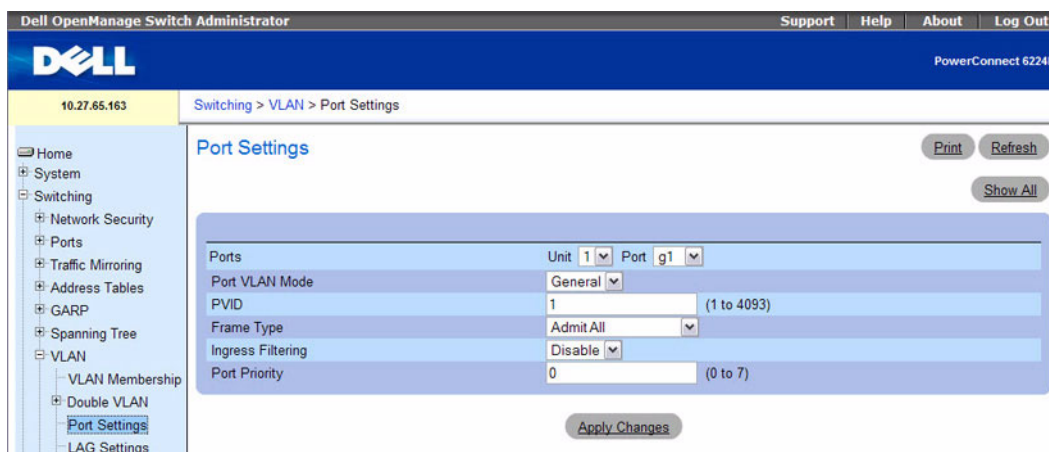

The **VLAN Port Settings** page contains the following fields:

- **Ports** — Specifies the Unit and Port included in the VLAN.
- **Port VLAN Mode** — Indicates the port mode. Possible values are:

- **General** — The port belongs to VLANs, and each VLAN is user-defined as tagged or untagged (full 802.1Q mode).
- **Access** — The port belongs to a single untagged VLAN. When a port is in Access mode, the packet types which are accepted on the port (packet type) cannot be designated. It is also not possible to enable/disable ingress filtering on an access port.
- **Trunk** — The port belongs to more than one VLAN, and all ports are tagged (except for an optional single native VLAN).
- **PVID (1–4093) | 4095** — Assigns a VLAN ID to untagged packets. Possible values are 1–4093 or 4095.
- **Frame Type** — Specifies frame type accepted on the port. Default is **Admit All**. Possible values are:
 - **Admit Tag Only**—Indicates that only tagged frames are accepted on the port.
 - **Admit All**—Indicates that both tagged and untagged frames are accepted on the port.
- **Ingress Filtering** — Enables or disables Ingress filtering on the port. Ingress filtering discards frames where the VLAN tag does not match the port VLAN membership.

Assigning Port Settings

1. Open the **VLAN Port Settings** page.
2. Select the port to which you want to assign settings from the **Unit** and **Port** drop-down menus.
3. Complete the remaining fields on the page.
4. Click **Apply Changes**.

The VLAN port settings are defined, and the device is updated.

Displaying the VLAN Port Table

1. Open the **VLAN Port Settings** page.
2. Click **Show All**.

The **VLAN Port Table** displays.

Figure 7-55. VLAN Port Table

Port	Port VLAN Mode	PVID	Frame Type	Ingress Filtering	Edit
1 1/xg1	Access	1	Admit All	Enable	<input type="checkbox"/>
2 1/xg2	Access	1	Admit All	Enable	<input type="checkbox"/>
3 1/xg3	General	3	Admit All	Enable	<input type="checkbox"/>

 **NOTE:** If an **Access** port is chosen, the packet types that are accepted on the port (packet type) cannot be designated. It is also not possible to enable or disable ingress filtering on an access port.

3. Use the **Unit** drop-down menu to view the **VLAN Port Table** for other units in the stack, if they exist.

Modifying Settings for Multiple Ports

1. Open the **VLAN Port Settings** page.

2. Click **Show All**.

The **VLAN Port Table** displays.

3. Click **Edit** for each Port to modify.

4. Edit fields as needed.

5. Click **Apply Changes**.

The VLAN port settings are modified, and the device is updated.

Configuring VLAN Ports Using CLI Commands

For information about the CLI commands that perform this function, see the following chapter in the *CLI Reference Guide*:

- **VLAN Commands**

The following table summarizes the equivalent CLI commands for this feature.

Table 7-28. VLAN Port Configuration Commands

CLI Command	Description
switchport access vlan	Configures the VLAN ID when the interface is in access mode.
switchport general acceptable-frame-type tagged-only	Discards untagged frames at ingress.
switchport general ingress-filtering disable	Disables port ingress filtering.
switchport general pvid	Configures the PVID when the interface is in general mode.
switchport mode	Configures the VLAN membership mode of a port.

VLAN LAG Settings

Use the **VLAN LAG Settings** page to map a LAG to a VLAN. Untagged packets entering the switch are tagged with the LAGs ID specified by the PVID.

To display the **VLAN LAG Settings** page, click **Switching** → **VLAN** → **LAG Settings** in the tree view.

Figure 7-56. VLAN LAG Settings

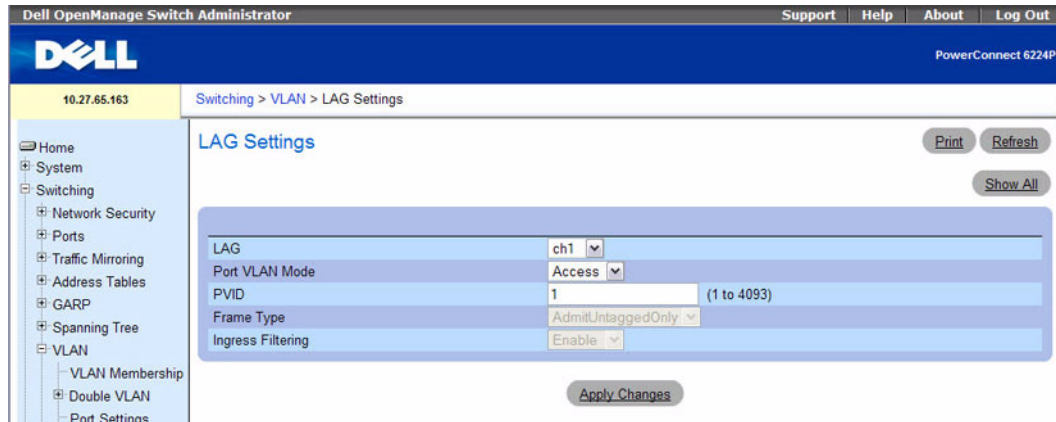

The VLAN LAG Settings page contains the following fields:

- **LAG** — Specifies the LAG number included in the VLAN.
- **Port VLAN Mode** — Indicates the Port VLAN mode for the LAG. Possible values are:
 - **General** — The LAG belongs to VLANs, and each VLAN is user-defined as tagged or untagged (full 802.1Q mode).
 - **Access** — The LAG belongs to a single, untagged VLAN.
- **Trunk** — The LAG belongs to more than one VLAN, and all ports are tagged (except for an optional single native VLAN).
- **PVID (1–4093) | 4095** — Assigns a VLAN ID to untagged packets. The possible field values are 1–4093 or 4095.
- **Frame Type** — Specifies packet type accepted by the LAG. Admit Tag Only is the default. Possible values are:
 - **Admit Tag Only** — The LAG only accepts tagged packets.
 - **Admit All** — Tagged and untagged packets are both accepted by the LAG.
- **Ingress Filtering** — Enables or disables Ingress filtering by the LAG. Ingress filtering discards packets where the VLAN tag does not match the LAG VLAN membership.

Assigning VLAN LAG Settings

1. Open the VLAN LAG Settings page.
2. Select a LAG from the LAG drop-down menu
3. Complete the remaining fields on the page.
4. Click Apply Changes.

The VLAN LAG parameters are defined, and the device is updated.

Displaying the VLAN LAG Table

1. Open the VLAN LAG Settings page.
2. Click Show All.

The VLAN LAG Table displays.

Figure 7-57. VLAN LAG Table

Port	Port VLAN Mode	PVID	Frame Type	Ingress Filtering	Edit
1 ch1	Access	1	Admit All	Enable	<input type="checkbox"/>
2 ch2	Access	1	Admit All	Enable	<input type="checkbox"/>
3 ch3	Access	1	Admit All	Enable	<input type="checkbox"/>
4 ch4	Access	1	Admit All	Enable	<input type="checkbox"/>
5 ch5	Access	1	Admit All	Enable	<input type="checkbox"/>
6 ch6	Access	1	Admit All	Enable	<input type="checkbox"/>
7 ch7	Access	1	Admit All	Enable	<input type="checkbox"/>
8 ch8	Access	1	Admit All	Enable	<input type="checkbox"/>

Modifying Settings for Multiple LAGs

1. Open the VLAN LAG Settings page.
2. Click Show All.

The VLAN LAG Table displays.

3. Click **Edit** for each LAG to modify.
4. Edit fields as needed.
5. Click **Apply Changes**.

The VLAN LAG settings are modified, and the device is updated.

Assigning LAGs to VLAN Groups Using CLI Commands

See "Configuring VLAN Ports Using CLI Commands" on page 370.

Bind MAC to VLAN

Use the Bind MAC to VLAN page to map a MAC entry to the VLAN table. After the source MAC address and the VLAN ID are specified, the MAC to VLAN configurations are shared across all ports of the switch. The MAC to VLAN table supports up to 128 entries.

To display the **Bind MAC to VLAN** page, click **Switching** → **VLAN** → **Bind MAC to VLAN** in the tree view.

Figure 7-58. Bind MAC to VLAN

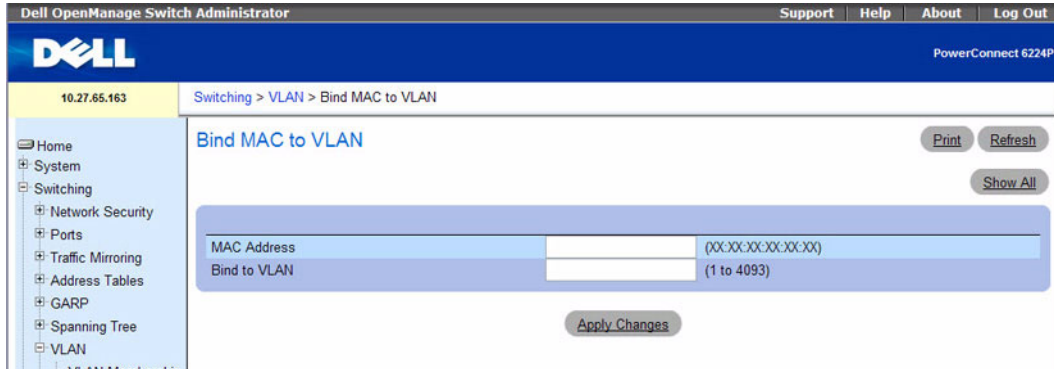

The **Bind MAC to VLAN** page contains the following fields:

- **MAC Address** — Specifies MAC Address for a VLAN.
- **Bind to VLAN (1–4093)** — Specifies VLAN to which the MAC is to be bound.

Assigning Bind MAC to VLAN Settings

1. Open the **Bind MAC to VLAN** page.
2. Enter the MAC Address to bind to the VLAN.
3. Enter the VLAN to which the MAC Address is to be bound.
4. Click **Apply Changes**.

The listed MAC Address and VLAN are now bound, and the device is updated.

Displaying the VLAN LAG Table

1. Open the **Bind MAC to VLAN** page.
2. Click **Show All**.

The **MAC - VLAN Bind Table** displays.

Figure 7-59. MAC - VLAN Bind Table

	MAC Address	Bind to VLAN	Remove	Edit
1	0800.6902.01FC	2	<input type="checkbox"/>	<input type="checkbox"/>
2	08B6.6902.0127	110	<input type="checkbox"/>	<input type="checkbox"/>

Modifying VLAN for Multiple MAC Addresses

1. Open the Bind MAC to VLAN page.
2. Click Show All.
The MAC - VLAN Bind Table displays.
3. Click Edit for each MAC Address with a VLAN to modify.
4. Edit the Bind to VLAN fields.
5. Click Apply Changes.

The MAC to VLAN settings are modified, and the device is updated.

Removing a MAC - VLAN Entry

1. Open the Bind MAC to VLAN page.
2. Click Show All.
The MAC - VLAN Bind Table displays.
3. Check Remove for each entry to remove.
4. Click Apply Changes.

The entry/entries are removed, and the device is updated.

Binding a MAC to a VLAN Using CLI Commands

For information about the CLI commands that perform this function, see the following chapter in the *CLI Reference Guide*:

- VLAN Commands

The following table summarizes the equivalent CLI commands for this feature.

Table 7-29. MAC - VLAN Binding Commands

CLI Command	Description
vlan association mac	Associates a MAC address to a VLAN.
show vlan association mac	Displays the VLAN associated with a specific configured MAC address.

Bind IP Subnet to VLAN

An IP Subnet to VLAN mapping is defined by configuring an entry in the IP Subnet to VLAN table, an entry is specified through a source IP address, network mask, and the desired VLAN ID. The IP Subnet to VLAN configurations are shared across all ports of the switch. There can be up to 64 entries configured in this table.

Use the **Bind IP Subnet to VLAN** page to assign an IP Subnet to a VLAN.

To display the **Bind IP Subnet to VLAN** page, click **Switching** → **VLAN** → **Bind IP Subnet to VLAN** in the tree view.

Figure 7-60. Bind IP Subnet to VLAN

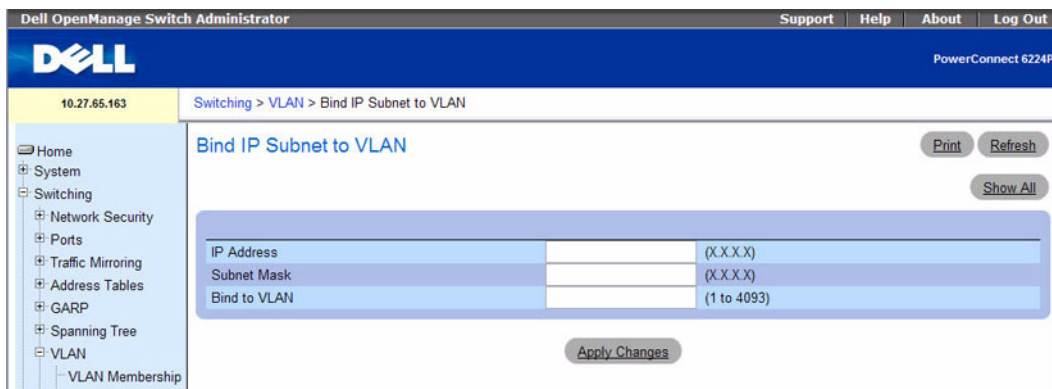

The **Bind IP Subnet to VLAN** page contains the following fields:

- **IP Address** — Specifies packet source IP address.
- **Subnet Mask** — Specifies packet source IP subnet mask.
- **Bind to VLAN (1-4093)** — Specifies VLAN to which the IP Address is assigned.

Binding an IP Subnet to a VLAN

1. Open the **Bind IP Subnet to VLAN** page.
2. Enter the IP Address to bind to the VLAN.
3. Enter the IP Subnet associated with the IP address.

4. Enter the VLAN ID to which the IP address and subnet mask are assigned.
5. Click **Apply Changes**.

The listed VLAN and IP Subnet are now bound, and the device is updated.

Displaying the IP Subnet - VLAN Bind Table

1. Open the **Bind IP Subnet to VLAN** page.
2. Click **Show All**.
3. The **IP Subnet - VLAN Bind Table** displays.

Figure 7-61. IP Subnet - VLAN Bind Table

	IP Address	Subnet Mask	Bind to VLAN	Remove	Edit
1	192.168.12.0	255.255.255.0	110	<input type="checkbox"/>	<input type="checkbox"/>
2	192.168.13.0	255.255.255.0	110	<input type="checkbox"/>	<input type="checkbox"/>
3	192.168.60.0	255.255.255.0	110	<input type="checkbox"/>	<input type="checkbox"/>

Modifying the VLAN Bound to Multiple IP Addresses

1. Open the **Bind IP Subnet to VLAN** page.
 2. Click **Show All**.
- The **IP Subnet - VLAN Bind Table** displays.

3. Click **Edit** for each entry to modify.
4. Edit the fields as needed.
5. Click **Apply Changes**.

The **Bind to VLAN** settings are modified, and the device is updated.

Removing a VLAN - IP Subnet Entry

1. Open the **Bind IP Subnet to VLAN** page.
 2. Click **Show All**.
- The **IP Subnet - VLAN Bind Table** displays.

3. Check **Remove** for each entry to remove.
4. Click **Apply Changes**.

The entry/entries are removed, and the device is updated.

Binding IP Subnets to VLANs Using CLI Commands

For information about the CLI commands that perform this function, see the following chapter in the *CLI Reference Guide*:

- VLAN Commands

The following table summarizes the equivalent CLI commands for this feature.

Table 7-30. IP Subnet - VLAN Binding Commands

CLI Command	Description
vlan association subnet	Associates an IP subnet to a VLAN
show vlan association subnet	Displays the VLAN associated with a specific configured IP subnet.

Protocol Group

In a protocol-based VLAN, traffic is bridged through specified ports based on the VLAN's protocol. User-defined packet filters determine if a particular packet belongs to a particular VLAN. Protocol-based VLANs are most often used in situations where network segments contain hosts running multiple protocols.

Use the **Protocol Group** page to configure which EtherTypes go to which VLANs, and then enable certain ports to use these settings.

To display the **Protocol Group** page, click **Switching** → **VLAN** → **Protocol Group** in the tree view.

Figure 7-62. Protocol Group

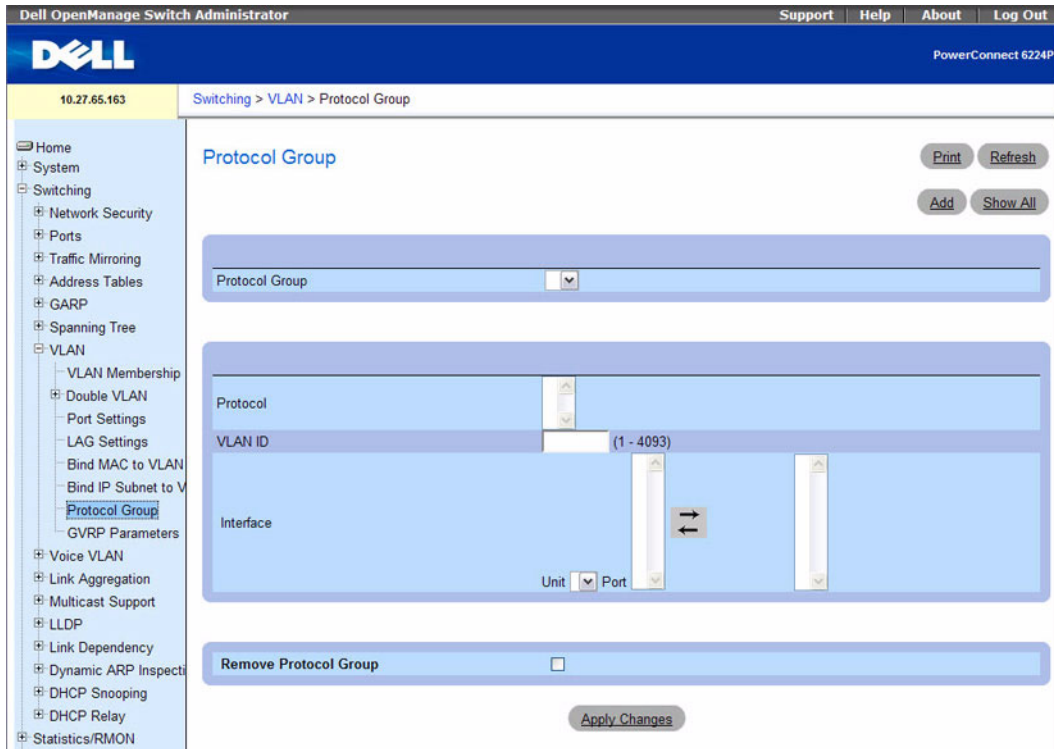

The **Protocol Group** page contains the following fields:

- **Protocol Group** — Displays the name associated with the protocol group ID (up to 16 characters). Create a new group by clicking the **Add** button.
- **Protocol** — Specifies protocols (in hexadecimal format in the range 0x0600 to 0xffff) associated with this group. Enter up to 16 protocols using comma separated list.
- **VLAN ID (1-4093)** — Specifies VLAN ID associated with this group.
- **Interface** — Selects the interface(s) to add or remove from this group. Highlight the interfaces to be in the protocol group and click the right arrow. Interfaces displayed in right-hand column are part of the protocol group.
- **Remove Protocol Group** — Removes the protocol group displayed on screen when checked and **Apply Changes** is clicked. To remove multiple groups at the same time, click **Show All** and use the **Remove** check boxes on the **Protocol Group Table**.

Adding a Protocol Group

1. Open the Protocol Group page.
2. Click Add.

The Add Protocol Group page displays.

Figure 7-63. Add Protocol Group



The screenshot shows a web interface for adding a protocol group. It features a title bar with 'Add Protocol Group' and 'First' and 'Refresh' buttons. Below the title bar is a form with three input fields: 'Group ID' (a dropdown menu showing '2'), 'Group Name' (a text input with a character limit of '(1 - 16 characters)'), and 'VLAN ID' (a text input with a character limit of '(1 to 4093)'). At the bottom of the form are 'Apply Changes' and 'Back' buttons.

3. Enter a new Protocol Group Name and a VLAN ID to associate with this group.
4. Return to the Protocol Group page.
5. Select the Protocol Group that you added, then select the protocol.
6. In the first Interface column, click to highlight the interfaces to be added to the protocol group. (To select multiple interfaces, press <Shift> (to select contiguous interfaces) or <Ctrl> (non-contiguous interfaces) when clicking.)
7. Click the right arrow.
Selected interfaces move to the second column. All interfaces in this column are part of the protocol group.
8. Click **Apply Changes**.
The protocol group is added, and the device is updated.

Modifying VLAN Protocol Group Settings

1. Open the Protocol Group page.
2. Specify the protocol to be modified from the Protocol Group ID drop-down menu.
3. Change Protocol or VLAN ID as needed.
4. To add an Interface to the group, click to highlight the desired interface in the first column. (To select multiple interfaces, press <Shift> (to select contiguous interfaces) or <Ctrl> (non-contiguous interfaces) when clicking.)
5. Click the right arrow.
Selected interface moves to the second column. All interfaces in this column are part of the protocol group.
6. To remove an Interface from the group, click to highlight the desired interface in the second column.
7. Click the left arrow.
Selected interface is removed from the second column.

- Click **Apply Changes**.

The VLAN protocol group parameters are modified, and the device is updated.

Removing Multiple Protocols From the Protocol Group Table

- Open the **Protocol Group** page.
- Click **Show All**.

The **Protocol Group Table** displays.

Figure 7-64. Protocol Group Table

The screenshot shows a web interface titled "Protocol Group Table" with "Print" and "Refresh" buttons in the top right. The table has six columns: Groupid, Group Name, Protocol, VLAN ID, Interface, and Remove. There are two rows of data. The first row has Groupid 1, Group Name 'ravindra', Protocol '0x8167, 0x8168', VLAN ID 1, Interface '1/sg1-1/sg7', and a Remove checkbox with an 'Edit' link. The second row has Groupid 2, Group Name 'delcolumbia', Protocol '0x8192, 0x8193', VLAN ID 2, Interface '1/sg19-1/sg24', and a Remove checkbox with an 'Edit' link. At the bottom of the interface are "Apply Changes" and "Back" buttons.

Groupid	Group Name	Protocol	VLAN ID	Interface	Remove
1	ravindra	0x8167, 0x8168	1	1/sg1-1/sg7	<input type="checkbox"/> Edit
2	delcolumbia	0x8192, 0x8193	2	1/sg19-1/sg24	<input type="checkbox"/> Edit

- Check **Remove** for the protocol groups you want to remove.
- Click **Apply Changes**.

The protocol is removed, and the device is updated.

Configuring VLAN Protocol Groups Using CLI Commands

For information about the CLI commands that perform this function, see the following chapter in the *CLI Reference Guide*:

- VLAN Commands

The following table summarizes the equivalent CLI commands for this feature.

Table 7-31. VLAN Protocol Group Commands

CLI Command	Description
vlan protocol group	Adds protocol-based VLAN groups to the system.
vlan protocol group add protocol	Adds a protocol to a protocol-based VLAN.
vlan protocol group name	Adds a group name to a protocol-based VLAN
vlan protocol group remove	Removes a protocol-base VLAN group.

GVRP Parameters

The GARP VLAN Registration Protocol provides a mechanism that allows networking switches to dynamically register (and de-register) VLAN membership information with the MAC networking switches attached to the same segment, and for that information to be disseminated across all networking switches in the bridged LAN that support GVRP.

The operation of GVRP relies upon the services provided by the Generic Attribute Registration Protocol (GARP). GVRP can create up to 1024 VLANs.

Use the **GVRP Global Parameters** page to enable GVRP globally. You can also enable GVRP on a per-interface basis.

To display the **GVRP Global Parameters** page, click **Switching** → **VLAN** → **GVRP Parameters** in the tree view.

Figure 7-65. GVRP Global Parameters

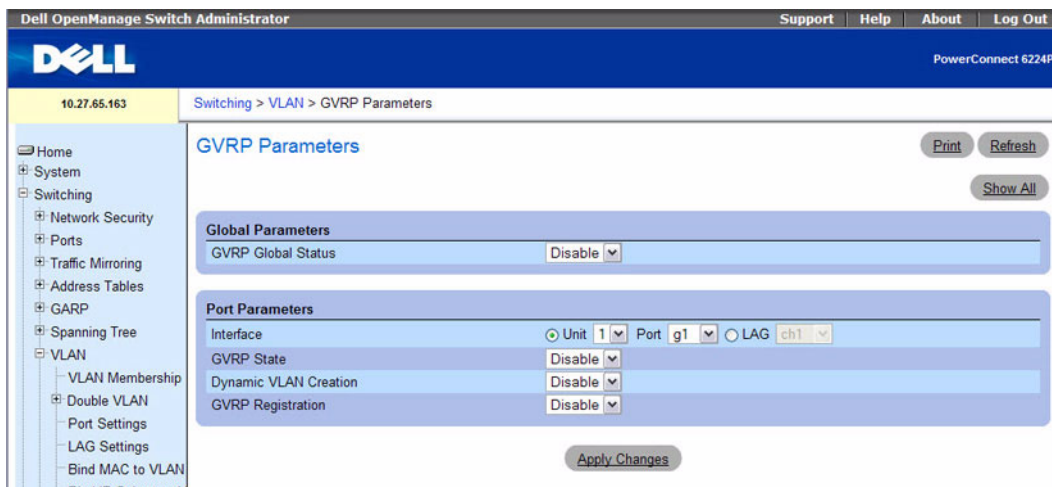

The **GVRP Global Parameters** page contains the following fields:

- **GVRP Global Status** — Enables or disables GVRP on the switch. GVRP is disabled by default.
- **Interface** — Specifies the Unit and Port or LAG for which GVRP is enabled.
- **GVRP State** — Enables or disables GVRP on the specified interface.
- **Dynamic VLAN Creation** — Enables or disables VLAN creation through GVRP.
- **GVRP Registration** — Enables or disables GVRP Registration.

Enabling GVRP On the Switch

1. Open the **GVRP Global Parameters** page.

2. Select **Enable** in the **GVRP Global Status** field.
3. Click **Apply Changes**.

GVRP is enabled on the switch.

Enabling VLAN Registration Through GVRP

1. Open the **GVRP Global Parameters** page.
2. Select **Enable** in the **GVRP Global Status** field for the desired interface.
3. Select **Enable** in the **GVRP Registration** field.
4. Click **Apply Changes**.

GVRP VLAN Registration is enabled on the port, and the device is updated.

Displaying the GVRP Port Parameters Table

1. Open the **GVRP Global Parameters** page.
2. Click **Show All**.

The **GVRP Port Parameters Table** displays.

Figure 7-66. GVRP Port Parameters Table

The screenshot shows the 'GVRP Port Parameters Table' interface. At the top, there is a 'Unit' dropdown menu set to '1' and a 'Copy Parameters From' section with radio buttons for 'Unit 1', 'Port xg1', and 'LAG ch1'. Below this is a table with the following data:

Interface	GVRP State	Dynamic VLAN Creation	GVRP Registration	Copy To	Edit
1 1/xg1	Disable	Disable	Disable	<input type="checkbox"/>	<input checked="" type="checkbox"/>
2 1/xg2	Disable	Disable	Disable	<input type="checkbox"/>	<input type="checkbox"/>
3 1/xg3	Disable	Disable	Disable	<input type="checkbox"/>	<input type="checkbox"/>

3. Use the **Unit** drop-down menu to view the **GVRP Port Parameters Table** for other units in the stack, if they exist.

Copying GVRP Parameters

1. Open the **GVRP Global Parameters** page.
2. Click **Show All**.

The **GVRP Port Parameters Table** displays.

3. Specify the Port or LAG you are copying from in **Copy Parameters From**.
4. Click **Copy To** for each Interface/LAG to receive these parameters.
5. Click **Apply Changes**.

The GVRP Port Parameter settings are copied, and the device is updated.

Modifying GVRP Parameters for Multiple Ports

1. Open the **GVRP Global Parameters** page.
2. Click **Show All**.
The **GVRP Port Parameters Table** displays.
3. Click **Edit** for each Interface/LAG to modify.
4. Edit the GVRP Port Parameter fields as needed.
5. Click **Apply Changes**.

The GVRP Port Parameter settings are modified, and the device is updated.

Configuring GVRP Using CLI Commands

For information about the CLI commands that perform this function, see the following chapter in the *CLI Reference Guide*:

- GVRP Commands

The following table summarizes the equivalent CLI commands for this feature.

Table 7-32. GVRP Commands

CLI Command	Description
clear gvrp statistics	Clears all the GVRP statistics information.
garp timer	Adjusts the GARP application join, leave, and leaveall GARP timer values.
gvrp enable (global)	Enables GVRP globally.
gvrp enable (interface)	Enables GVRP on an interface.
gvrp registration-forbid	De-registers all VLANs, and prevents dynamic VLAN registration on the port.
gvrp vlan-creation-forbid	Enables or disables dynamic VLAN creation.
show gvrp configuration	Displays GVRP configuration information, including timer values, whether GVRP and dynamic VLAN creation is enabled, and which ports are running GVRP
show gvrp error-statistics	Displays GVRP error statistics.
show gvrp statistics	Displays GVRP statistics.

Configuring Voice VLAN

The Voice VLAN feature enables switch ports to carry voice traffic with defined priority. The priority level enables the separation of voice and data traffic coming onto the port. A primary benefit of using Voice VLAN is to ensure that the sound quality of an IP phone is safeguarded from deteriorating when the data traffic on the port is high. The system uses the source MAC address of the traffic traveling through the port to identify the IP phone data flow.

The Voice VLAN feature supports a configurable voice VLAN DSCP parameter. This allows you to set the DSCP value. This value is later retrieved by LLDP when the LLDPDU is transmitted if LLDP has been enabled on the port and the required TLV is configured for the port.

Use the Voice VLAN Configuration page to configure and view voice VLAN settings that apply to the entire system and to specific interfaces.

To display the page, click **Switching** → **Voice VLAN** → **Configuration** in the tree view.

Figure 7-67. Voice VLAN Configuration

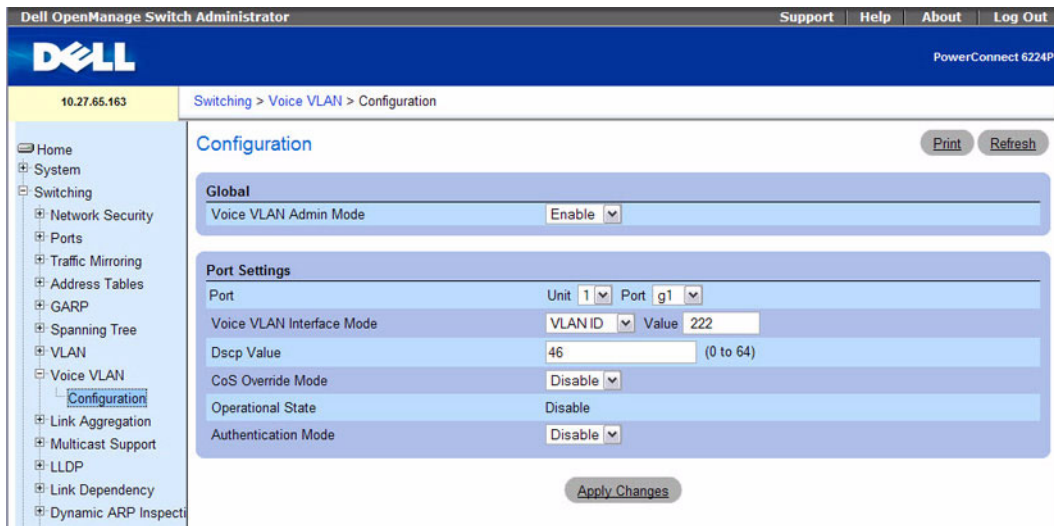

The Voice VLAN Configuration page contains the following fields:

- **Voice VLAN Admin Mode** — Select the administrative mode for Voice VLAN for the switch from the drop-down menu. The default is disable.
- **Port** — Select the interface to view or configure.
- **Voice VLAN Interface Mode** — Select the Voice VLAN mode for selected interface. The default is disable. The mode can be one of the following:
 - **Disable** — Disable voice VLAN on the port.

- **None** — Allow the IP phone to use its own configuration to send untagged voice traffic.
- **VLAN ID** — Configure VLAN tagging for the voice traffic. The VLAN ID range is 1–4093.
- **dot1p** — Configure Voice VLAN 802.1p priority tagging for voice traffic. The priority tag range is 0–7.
- **Untagged** — Configure the phone to send untagged voice traffic.
- **DSCP Value** — Configures the Voice VLAN DSCP value for the port. The default value is 46.
- **CoS Override Mode** — Select the Cos Override mode for selected interface. The default is disable.
- **Operational State** — This is the operational status of the voice VLAN on the given interface.
- **Authentication Mode** — Enable or disable 802.1X authentication on the voice VLAN. When voice VLAN authentication is disabled, VoIP devices may use the voice VLAN without authenticating.



NOTE: IEEE 802.1X must be enabled on the switch before you disable voice VLAN authentication. Voice VLAN authentication can be disabled in order to allow VoIP phones that do not support authentication to send and receive unauthenticated traffic on the Voice VLAN.

Configuring Voice VLAN Settings

1. Open the **Voice VLAN Configuration** page.
2. Configure the settings for the system or for each port.
3. Click **Apply Changes**.

The system parameters are applied, and the device is updated.

Configuring Voice VLAN Using CLI Commands

For information about the CLI commands that perform this function, see the following chapter in the CLI Reference Guide:

- [Voice VLAN Commands](#)

The following table summarizes the equivalent CLI commands for this feature.

Table 7-33. Voice VLAN Commands

CLI Command	Description
voice vlan	Enables the voice VLAN capability on the switch.
voice vlan (interface)	Enables the voice VLAN capability on the interface
show voice vlan	Displays various properties of the voice VLAN.

Aggregating Ports

Link Aggregation allows one or more full-duplex (FDX) Ethernet links to be aggregated together to form a Link Aggregation Group (LAG). This allows the networking switch to treat the LAG as if it is a single link.

Static LAGs are supported. When a port is added to a LAG as a static member, it neither transmits nor receives LACPDU.

To display the **Link Aggregation** menu page, click **Switching** → **Link Aggregation** in the tree view. The **Link Aggregation** page contains links to the following features:

- LACP Parameters
- LAG Membership
- LAG Hash Configuration
- LAG Hash Summary

LACP Parameters

Link Aggregation is initiated and maintained by the periodic exchanges of LACPDUs. Use the **LACP Parameters** page to configure LACP LAGs.

To display the **LACP Parameters** page, click **Switching** → **Link Aggregation** → **LACP Parameters** in the tree view.

Figure 7-68. LACP Parameters

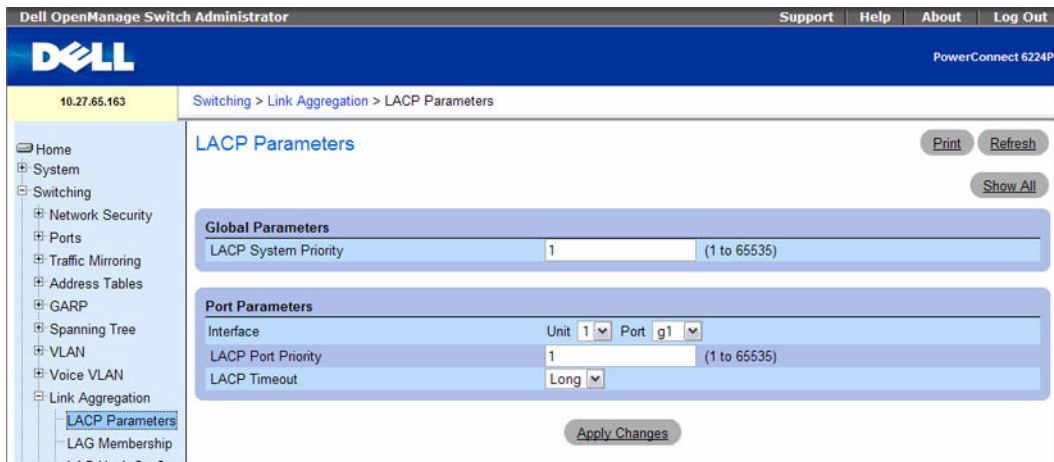

The **LACP Parameters** page is divided into two sections: Global Parameters and Port Parameters. Following are the fields on this page:

Global Parameters

- **LACP System Priority (1–65535)** — Indicates the LACP priority value for global settings. The default value is 1.

Port Parameters

- **Interface**— Specifies the unit and port number to which timeout and priority values are assigned.
- **LACP Port Priority (1–65535)** — Specifies LACP priority value for the specified port. The default value is 1.
- **LACP Timeout** — Specifies Administrative LACP timeout. Possible values are:
 - **Short** — Specifies a short timeout value.
 - **Long** — Specifies a long timeout value. This is the default.

Defining Link Aggregation Parameters

1. Open the **LACP Parameters** page.
2. Complete the fields as needed.
3. Click **Apply Changes**.
The parameters are defined, and the device is updated.

Displaying the LACP Parameters Table

1. Open the **LACP Parameters** page.
2. Click **Show All**.
The **LACP Parameters Table** displays.

Figure 7-69. LACP Parameters Table



LACP Parameters Table

Unit: 1

	Port	Port-Priority	LACP Timeout	Edit
1	1/xg	128	Long	<input checked="" type="checkbox"/>
2	1/xg	128	Long	<input type="checkbox"/>
3	1/xg	128	Long	<input type="checkbox"/>

3. Use the **Unit** drop-down menu to view the **LACP Parameters Table** for other units in the stack, if they exist.

Modifying LACP Parameters for Multiple Ports

1. Open the **LACP Parameters** page.

2. Click **Show All**.

The **LACP Parameters Table** displays.

3. Click **Edit** for each Port to modify.

4. Edit the fields as needed.

5. Click **Apply Changes**.

The LACP Parameter settings are modified, and the device is updated.

Configuring LACP Parameters Using CLI Commands

For information about the CLI commands that perform this function, see the following chapter in the *CLI Reference Guide*:

- LACP Commands

The following table summarizes the equivalent CLI commands for this feature.

Table 7-34. LACP Commands

CLI Command	Description
lacp port-priority	Configures the priority value for physical ports.
lacp system-priority	Configures the system LACP priority.
lacp timeout	Assigns an administrative LACP timeout.
show lacp ethernet	Displays LACP information for Ethernet ports.
show lacp port-channel	Displays LACP information for a port-channel.

LAG Membership

Your switch supports 48 LAGs per system, and eight ports per LAG. Use the **LAG Membership** page to assign ports to LAGs and LACPs.

To display the **LAG Membership** page, click **Switching** → **Link Aggregation** → **LAG Membership** in the tree view.

Figure 7-70. LAG Membership

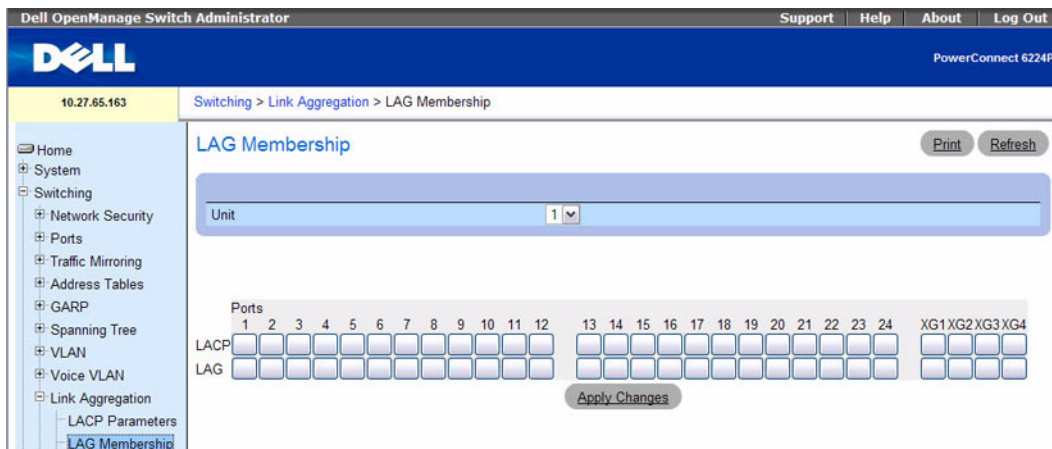

The **LAG Membership** page contains a table with the following fields:

- **LACP** — Aggregates a LAG port to LACP membership. For ports with a number in the LAG row, you can click in the LACP row to toggle LACP "on." Each click toggles between L (LACP) and blank (no LACP).
- **LAG** — Adds a port to a LAG, and indicates the specific LAG to which the port belongs. Each click toggles through the LAG numbers, 1–48, and then back to blank (no LAG assigned).

Adding a Port to a LAG

1. Open the **LAG Membership** page.

2. Click in the **LAG** row to toggle the port to the desired LAG.

The LAG number displays for that port. The LAG number increases each time you click until the number reaches 48 and then returns to blank (no LAG assigned).

3. Click **Apply Changes**.

The port is assigned to the selected LAG, and the device is updated.

Adding a LAG Port to an LACP

1. Open the **LAG Membership** page.

2. Click in the **LACP** row to toggle the desired LAG port to **L**.

 **NOTE:** The port must be assigned to a LAG before it can be aggregated to an LACP.

3. Click **Apply Changes**.

The LAG port is aggregated to the LACP, and the device is updated.

Assigning Ports to LAGs and LACPs Using CLI Commands

For information about the CLI commands that perform this function, see the following chapter in the *CLI Reference Guide*:

- Port Channel Commands

The following table summarizes the equivalent CLI commands for this feature.

Table 7-35. LAG Membership Commands

CLI Command	Description
channel-group	Associates a port with a port-channel.

LAG Hash Configuration

Use the LAG HASH algorithm to set the traffic distribution mode on the aggregator link. You can set the HASH type for each trunk.

To display the LAG Hash Configuration page, click **Switching** → **Link Aggregation** → **LAG Hash Configuration** in the tree view.

Figure 7-71. LAG Hash Configuration

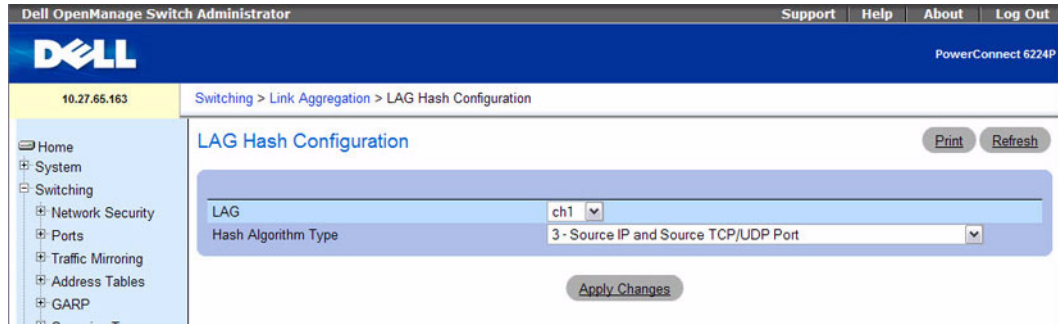

The LAG Hash Configuration page contains the following fields:

- **LAG** — The drop-down menu lists the LAG numbers.
- **Hash Algorithm Type** — The HASH algorithm for unicast traffic flows can be one of the following types:
 - Source MAC, VLAN, EtherType, SourceModule and Port Id
 - Destination MAC, VLAN, EtherType, SourceModule and Port Id
 - Source IP and Source TCP/UDP Port (default)
 - Destination IP and Destination TCP/UDP Port

- Source/Destination MAC, VLAN, EtherType, source MODID/port
- Source/Destination IP and source/destination TCP/UDP port

Configuring the LAG Hash

1. Open the **LAG Hash Configuration** page.
2. Select the LAG to configure and the hash algorithm to assign to the LAG.
3. Click **Apply Changes**.

The parameters are modified, and the device is updated.

Configuring the LAG Hash Using CLI Commands

For information about the CLI commands that perform this function, see the following chapter in the *CLI Reference Guide*:

- Port Channel Commands

The following table summarizes the equivalent CLI commands for this feature.

Table 7-36. LAG Hash Commands

CLI Command	Description
hashing-mode	Sets the hashing algorithm on trunk ports.
no hashing-mode	Sets the hashing algorithm on trunk ports to default (3).

LAG Hash Summary

The **LAG Hash Summary** page lists the channels on the system and their assigned hash algorithm type. To display the **LAG Hash Summary** page, click **Switching** → **Link Aggregation** → **LAG Hash Summary** in the tree view.

Figure 7-72. LAG Hash Summary

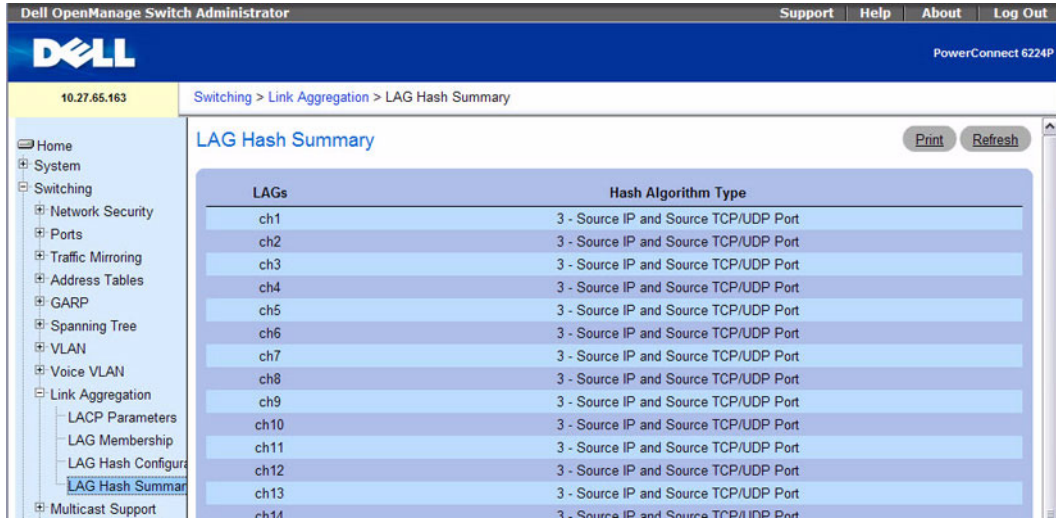

The LAG Hash Summary page contains a table with the following fields:

- **LAGs** — Lists the LAG numbers.
- **Hash Algorithm Type** — Shows the type of HASH algorithm for unicast traffic flows that is associated with the LAG.

Viewing the LAG Hash Algorithm Summary Using CLI Commands

For information about the CLI commands that perform this function, see the following chapter in the *CLI Reference Guide*:

- Port Channel Commands

The following table summarizes the equivalent CLI commands for this feature.

Table 7-37. LAG Hash Summary Command

CLI Command	Description
show interfaces port-channel	Displays port-channel information.

Managing Multicast Support

The Layer 2 Multicast Forwarding Database is used by the switch to make forwarding decisions for packets that arrive with a multicast destination MAC address. By limiting multicasts to only certain ports in the switch, traffic is prevented from going to parts of the network where that traffic is unnecessary.

When a packet enters the switch, the destination MAC address is combined with the VLAN ID and a search is performed in the Layer 2 Forwarding database. If no match is found, then the packet is either flooded to all ports in the VLAN or discarded, depending on the switch configuration. If a match is found, then the packet is forwarded only to the ports that are members of that multicast group.

To display the **Multicast Support** menu page, click **Switching** → **Multicast Support** in the tree view. This **Multicast Support** page contains links to the following features:

- Multicast Global Parameters
- Bridge Multicast Group
- Bridge Multicast Forward
- IGMP Snooping
- MRouter Status
- MLD Snooping

Multicast Global Parameters

Use the **Multicast Global Parameters** page to enable bridge multicast filtering or IGMP Snooping on the switch. Parameters for these features can be modified from the **Bridge Multicast Forward** and **IGMP Snooping** web pages.

To display the **Multicast Global Parameters** page, click **Switching** → **Multicast Support** → **Global Parameters** in the tree view.

Figure 7-73. Multicast Global Parameters

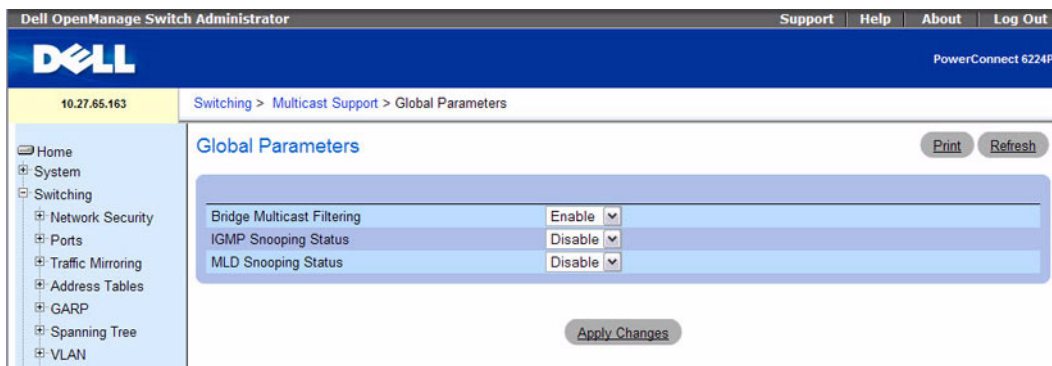

The **Multicast Global Parameters** page contains the following field:

- **Bridge Multicast Filtering** — Enables or disables bridge Multicast filtering. The default value is disabled.
- **IGMP Snooping Status** — Enables or disables IGMP snooping. The default value is disabled.
- **MLD Snooping Status** — Enables or disables MLD snooping. The default value is disabled.

Enabling Bridge Multicast Filtering on the Switch

1. Open the **Multicast Global Parameters** page.
2. Select **Enable** in the **Bridge Multicast Filtering** field.
3. Click **Apply Changes**.

Bridge Multicast is enabled on the switch.

Enabling Multicast Forwarding and/or IGMP Snooping Using CLI Commands

For information about the CLI commands that perform this function, see the following chapter in the *CLI Reference Guide*:

- Multicast Commands

The following table summarizes the equivalent CLI commands for this feature.

Table 7-38. Multicast Commands

CLI Command	Description
bridge multicast filtering	Enables filtering of Multicast addresses.
ip igmp snooping	Enable Internet Group Management Protocol (IGMP) snooping globally or on an interface.
ipv6 mld snooping	Enables MLD Snooping globally or on an interface.
show ip mcast	Displays the system-wide multicast information.
show ip igmp snooping interface	Displays IGMP snooping configuration.

Bridge Multicast Group

Use the **Bridge Multicast Group** page to create new multicast service groups or to modify ports and LAGs assigned to existing multicast service groups. Attached interfaces display in the Port and LAG tables, and reflect the manner in which each is joined to the Multicast group.

To display the **Bridge Multicast Group** page, click **Switching** → **Multicast Support** → **Bridge Multicast Group** in the tree view.

Figure 7-74. Bridge Multicast Group

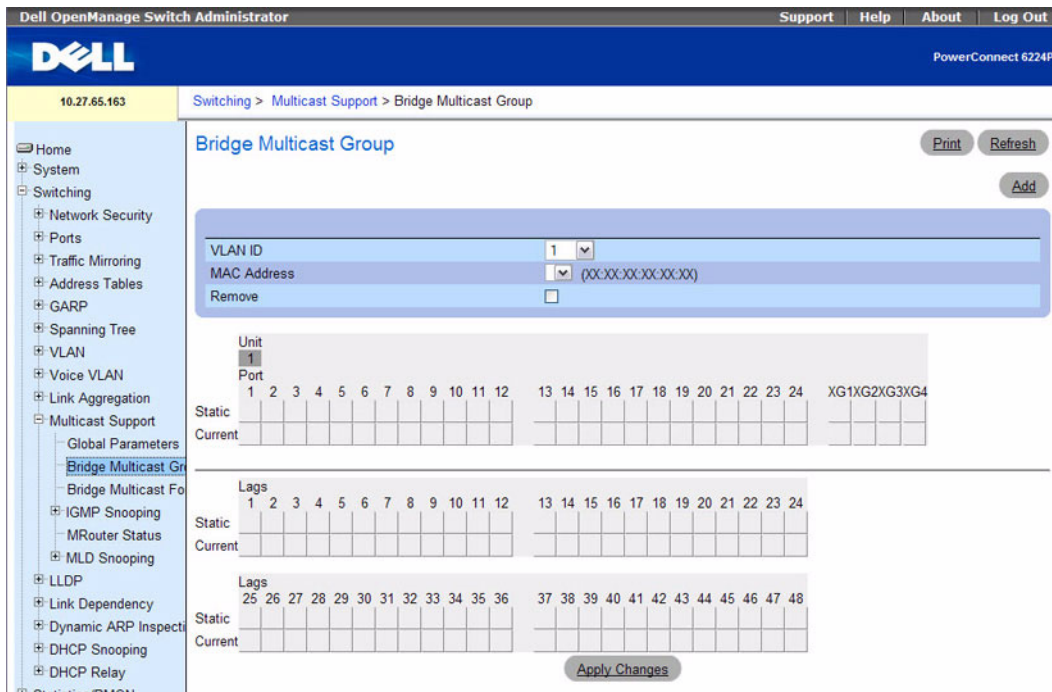

The **Bridge Multicast Group** page contains the following fields:

- **VLAN ID** — Selects the VLAN to add a multicast group to or to modify ports on an existing multicast group.
- **Bridge Multicast Address** — Identifies the multicast group MAC address/IP address associated with the selected VLAN ID. Use the **Add** button to associate a new address with a VLAN ID.
- **Remove** — Removes a Bridge Multicast address when checked.

Port and LAG Member Tables

The **Bridge Multicast Group** tables display which Ports and LAGs are members of the multicast group, and whether they're static (S), dynamic (D), or forbidden (F). The tables have two rows: **Static** and **Current**. Only the **Static** row is accessible from this page. The **Current** row is updated when the **Static** row is changed and **Apply Changes** is clicked.

The **Bridge Multicast Group** page contains two editable tables:

- **Unit and Ports** — Displays and assigns multicast group membership to ports. To assign membership, click in **Static** for a specific port. Each click toggles between S, F, and blank. See the following table for definitions.

- **LAGs** — Displays and assigns multicast group membership to LAGs. To assign membership, click in **Static** for a specific LAG. Each click toggles between S, F, and blank. See the following table for definitions.

The following table contains definitions for port/LAG IGMP management settings.

Table 7-39. Port/LAG IGMP Management Settings

Port Control	Definition
D	Dynamic: Indicates that the port/LAG was dynamically joined to the Multicast group (displays in the <i>Current</i> row).
S	Static: Attaches the port to the Multicast group as a static member in the <i>Static</i> row. Displays in the <i>Current</i> row once Apply Changes is clicked.
F	Forbidden: Indicates that the port/LAG is forbidden entry into the Multicast group in the <i>Static</i> row. Displays in the <i>Current</i> row once Apply Changes is clicked.
Blank	Blank: Indicates that the port is not attached to a Multicast group.

Adding Bridge Multicast Addresses

1. Open the **Bridge Multicast Group** page.
2. Click **Add**.

The **Add Bridge Multicast Group** page displays.

Figure 7-75. Add Bridge Multicast Group

Add Bridge Multicast Group Print Refresh

VLAN ID: 110

Multicast IP Address: 225.0.0.0 (0XXX0)

Multicast MAC Address: 000000000000

Unit: 1

Port: 1 2 3 4 5 6 7 8 9 10 11 12 13 14 15 16 17 18 19 20 21 22 23 24

6 S 7 F 8 F 9 S

Lags: 1 2 3 4 5 6 7 8

Apply Changes Back

3. Select the **VLAN ID** from the drop-down menu.
4. Define the **New Bridge Multicast IP or MAC** address.
5. In the **Bridge Multicast Group** tables, assign a setting by clicking in the **Static** row for a specific port/LAG. Each click toggles between S, F, and blank. (not a member).
6. Click **Apply Changes**.

The bridge multicast address is assigned to the multicast group, ports/LAGs are assigned to the group (with the **Current** rows being updated with the **Static** settings), and the device is updated.

Assigning an Interface to an existing Multicast Group

1. Open the **Bridge Multicast Group** page.
2. Select the **VLAN ID** from the drop-down menu.
The associated **Bridge Multicast Address** displays.
3. In the **Bridge Multicast Group** tables, assign a setting by clicking in the **Static** row for a specific port/LAG. Each click toggles between S, F, and blank (not a member).
4. Click **Apply Changes**.

The interface is assigned to the multicast group, the **Current** row is updated with the **Static** setting, and the device is updated.

Removing a Bridge Multicast Group

1. Open the **Bridge Multicast Group** page.
2. Select the **VLAN ID** associated with the bridge multicast group to be removed from the drop-down menu.
The **Bridge Multicast Address** and the assigned ports/LAGs display.
3. Check the **Remove** check box.
4. Click **Apply Changes**.

The selected bridge multicast group is removed, and the device is updated.

Managing Bridge Multicast Groups Using CLI Commands

For information about the CLI commands that perform this function, see the following chapter in the *CLI Reference Guide*:

- Address Table Commands

The following table summarizes the equivalent CLI commands for this feature.

Table 7-40. Bridge Multicast Groups Commands

CLI Command	Description
bridge multicast address	Register MAC Layer Multicast addresses to the bridge table and adds ports to the group statically.
bridge multicast forbidden address	Forbids adding a specific Multicast address to specific ports.
show bridge multicast address-table	Displays Multicast MAC address table information.

Bridge Multicast Forward

Use the **Bridge Multicast Forward** page to enable attaching ports or LAGs to a switch that is attached to a neighboring Multicast switch. Once IGMP Snooping is enabled, multicast packets are forwarded to the appropriate port or VLAN.

To display the **Bridge Multicast Forward** page, click **Switching** → **Multicast Support** → **Bridge Multicast Forward** in the tree view.

Figure 7-76. Bridge Multicast Forward

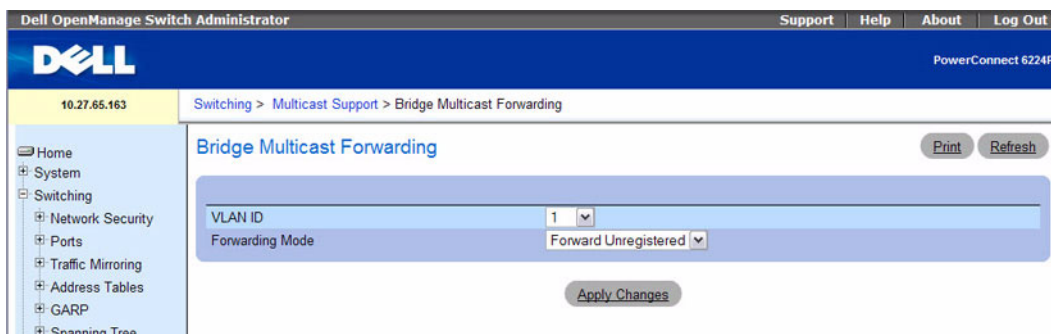

The **Bridge Multicast Forward** page contains the following field and two editable tables:

- **VLAN ID** — Selects the VLAN to be affected.
- **Forwarding Mode** — Specifies the multicast forwarding mode for the selected VLAN. Possible values are:
 - **Forward Unregistered** — Permits the forwarding of IPv4 multicast packets with a destination address that does not match any of the groups announced in earlier IGMP Membership Reports.
 - **Forward All** — Permits registered and unregistered multicast packets to forward.
 - **Filter Unregistered** — Prohibits the forwarding of IPv4 multicast packets with a destination address that does not match any of the groups announced in earlier IGMP Membership Reports.

Changing the Bridge Multicast Forwarding Mode.

1. Open the **Bridge Multicast Forward** page.
2. Select the **VLAN ID** from the drop-down menu.
3. Select the **Forwarding Mode** to assign the VLAN from the drop-down menu.
4. Click **Apply Changes**.

The VLAN is updated with the **Forwarding Mode** setting, and the device is updated.

Configuring Bridge Multicast Forwarding Using CLI Commands

For information about the CLI commands that perform this function, see the following chapter in the *CLI Reference Guide*:

- Address Table Commands

The following table summarizes the equivalent CLI commands for this feature.

Table 7-41. Bridge Multicast Forwarding Commands

CLI Command	Description
bridge multicast forbidden forward-unregistered	Forbids forwarding-unregistered-multicast-addresses.
bridge multicast forward-all	Enables forwarding of all Multicast packets.
bridge multicast forward-unregistered	Enable the forwarding of unregistered multicast addresses.

IGMP Snooping

Internet Group Management Protocol (IGMP) Snooping is a feature that allows a switch to forward multicast traffic intelligently on the switch. Multicast IP traffic is traffic that is destined to a host group. Host groups are identified by class D IP addresses, which range from 224.0.0.0 to 239.255.255.255. Based on the IGMP query and report messages, the switch forwards traffic only to the ports that request the multicast traffic. This prevents the switch from broadcasting the traffic to all ports and possibly affecting network performance.

When a packet with a broadcast or multicast destination address is received, the switch will forward a copy into each of the remaining network segments in accordance with the IEEE MAC Bridge standard. Eventually, the packet is made accessible to all nodes connected to the network.

This approach works well for broadcast packets that are intended to be seen or processed by all connected nodes. In the case of multicast packets, however, this approach could lead to less efficient use of network bandwidth, particularly when the packet is intended for only a small number of nodes. Packets will be flooded into network segments where no node has any interest in receiving the packet.

Allowing switches to snoop IGMP packets is a creative effort to solve this problem. The switch uses the information in the IGMP packets as they are being forwarded throughout the network to determine which segments should receive packets directed to the group address.

To display the **IGMP Snooping** page, click **Switching** → **Multicast Support** → **IGMP Snooping** in the tree view. Use this page to go to the following features:

- General IGMP Snooping
- Global Querier Configuration
- VLAN Querier
- VLAN Querier Status
- MFDB IGMP Snooping Table

General IGMP Snooping

Use the **General IGMP snooping** page to add IGMP members.

To display the **General IGMP snooping** page, click **Switching** → **Multicast Support** → **IGMP Snooping** → **General** in the tree view.

Figure 7-77. General IGMP Snooping

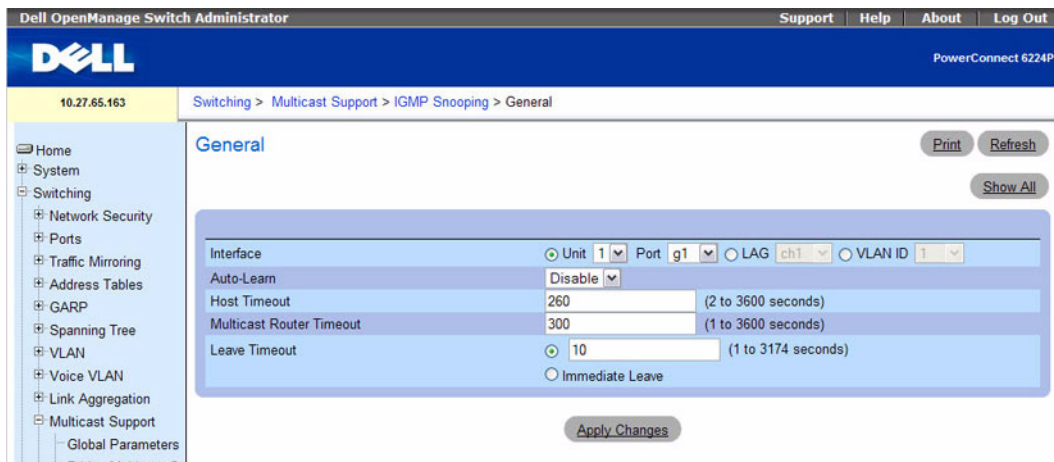

The **General IGMP snooping** page contains the following fields:

- **Interface** — Selects the Unit and Port, LAG, or VLAN to be affected.
- **Auto-Learn** — Enables or disables Auto-Learn on the switch.
- **Host Timeout** — Specifies time before an IGMP snooping entry is aged out. The default time is 260 seconds.
- **Multicast Router Timeout** — Specifies time before aging out a Multicast router entry. The default value is 300 seconds.

- **Leave Timeout** — Specifies time, in seconds, after a port leave message is received before the entry is aged out. Enter an amount of time for the timeout period, or click **Immediate Leave** to specify an immediate timeout. The default timeout is 10 seconds.

Enabling IGMP Snooping on an Interface

1. Open the **General IGMP snooping** page.
2. Select the unit and port, LAG, or VLAN to configure from the **Interface** field.
3. Complete the fields on the page as needed.
4. Click **Apply Changes**.
IGMP snooping is enabled on the selected interface.

Displaying the IGMP Snooping Table

1. Open the **IGMP Snooping** page.
2. Click **Show All**.
The **IGMP Snooping Table** displays.

Figure 7-78. IGMP Snooping Table

Port	Auto Learn Enable	Host Timeout	Multicast Router Timeout	Leave Timeout	Copy To	Edit
1 1/g1	Disable	260	300	10	<input type="checkbox"/>	<input type="checkbox"/>
2 1/g2	Disable	260	300	10	<input type="checkbox"/>	<input type="checkbox"/>
3 1/g3	Disable	260	300	10	<input type="checkbox"/>	<input type="checkbox"/>
4 1/g4	Disable	260	300	10	<input type="checkbox"/>	<input type="checkbox"/>
5 1/g5	Disable	260	300	10	<input type="checkbox"/>	<input type="checkbox"/>
6 1/g6	Disable	260	300	10	<input type="checkbox"/>	<input type="checkbox"/>
7 1/g7	Disable	260	300	10	<input type="checkbox"/>	<input type="checkbox"/>
8 1/g8	Disable	260	300	10	<input type="checkbox"/>	<input type="checkbox"/>

3. Use the **Unit** drop-down menu to view the **IGMP Snooping Table** for other units in the stack, if they exist.

Modifying IGMP Snooping Settings for Multiple Ports, LAGs, or VLANs

1. Open the **General IGMP snooping** page.
2. Click **Show All**.
The **IGMP Snooping Table** displays.
3. Click **Edit** for each Port, LAG, or VLAN to modify.
4. Edit the IGMP Snooping fields as needed.

5. Click **Apply Changes**.

The IGMP Snooping settings are modified, and the device is updated.

Copying IGMP Snooping Settings to Multiple Ports, LAGs, or VLANs

1. Open the **General IGMP snooping** page.
2. Click **Show All**.

The **IGMP Snooping Table** displays.

3. Click **Copy Parameters From**.
4. Select a Unit/Port, LAG, or VLAN to use as the source of the desired parameters.
5. Click **Copy To** for the Unit/Ports, LAGs, or VLANs that these parameters will be copied to.
6. Click **Apply Changes**.

The IGMP Snooping settings are modified, and the device is updated.

Configuring General IGMP Snooping Settings with CLI Commands

For information about the CLI commands that perform this function, see the following chapter in the CLI Reference Guide:

- IGMP Snooping Commands

The following table summarizes the equivalent CLI commands for this feature.

Table 7-42. IGMP Snooping Commands

CLI Command	Description
ip igmp snooping (Interface)	Enables Internet Group Management Protocol (IGMP) snooping on a specific VLAN.
ip igmp snooping host-time-out	Configures the host-time-out.
ip igmp snooping leave-time-out	Configures the leave-time-out.
ip igmp snooping mrouter-time-out	Configures the mrouter-time-out.
show ip igmp snooping groups	Displays Multicast groups learned by IGMP snooping.
show ip igmp snooping interface	Displays IGMP snooping configuration.
ip igmp snooping (VLAN)	In VLAN Config mode, enables IGMP snooping on a particular VLAN or on all interfaces participating in a VLAN.
ip igmp snooping fast-leave	Enables or disables IGMP Snooping fast-leave mode on a selected VLAN.
ip igmp snooping groupmembership-interval	Sets the IGMP Group Membership Interval time on a VLAN.

Table 7-42. IGMP Snooping Commands (continued)

CLI Command	Description
ip igmp snooping maxresponse	Sets the IGMP Maximum Response time on a particular VLAN.
ip igmp snooping mcrtr_expiretime	Sets the Multicast Router Present Expiration time.

Global Querier Configuration

Use the **Global Querier Configuration** page to configure the parameters for the IGMP Snooping Querier.

To display the **Global Querier Configuration** page, click **Switching** → **Multicast Support** → **IGMP Snooping** → **Global Querier Configuration** in the tree view.

Figure 7-79. Global Querier Configuration

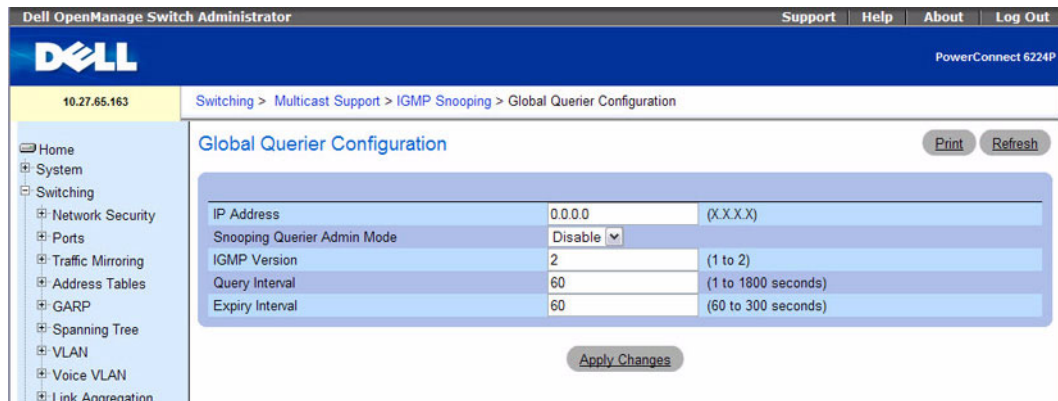

The **Global Querier Configuration** page contains the following fields:

- **IP Address**— Specifies the Snooping Querier IP Address which will be used as the source address in periodic IGMP queries. This address is used when no address is configured for the VLAN on which the query is being sent.
- **Snooping Querier Admin Mode** — Enables or disables the administrative mode for IGMP Snooping for the switch.
- **IGMP Version** — Specifies the version of IGMP protocol used in periodic IGMP queries.
- **Query Interval (1–1800)** — Specifies the time interval in seconds between periodic queries sent by the Snooping Querier. The default value is 60.
- **Expiry Interval (60–300)** — Specifies the time interval in seconds after which the last querier information is removed. The default value is 60.

Configuring IGMP Snooping Querier Settings with CLI Commands

For information about the CLI commands that perform this function, see the following chapter in the CLI Reference Guide:

- IGMP Snooping Querier Commands

The following table summarizes the equivalent CLI commands for this feature.

Table 7-43. IGMP Snooping Querier Global Commands

CLI Command	Description
ip igmp snooping querier	Enables/disables IGMP Snooping Querier on the system (Global Configuration mode) or on a VLAN.
ip igmp snooping querier election participate	Enables the Snooping Querier to participate in the Querier Election process when it discovers the presence of another Querier in the VLAN.
ip igmp snooping querier query-interval	Sets the IGMP Querier Query Interval time.
ip igmp snooping querier timer expiry	Sets the IGMP Querier timer expiration period.
ip igmp snooping querier version	Sets the IGMP version of the query that the snooping switch is going to send periodically.
show igmp snooping querier	Displays IGMP Snooping Querier information.

VLAN Querier

Use the VLAN Querier page to specify the IGMP Snooping Querier settings for individual VLANs.

To display the VLAN Querier page, click **Switching** → **Multicast Support** → **IGMP Snooping** → **VLAN Querier** in the tree view.

Figure 7-80. VLAN Querier

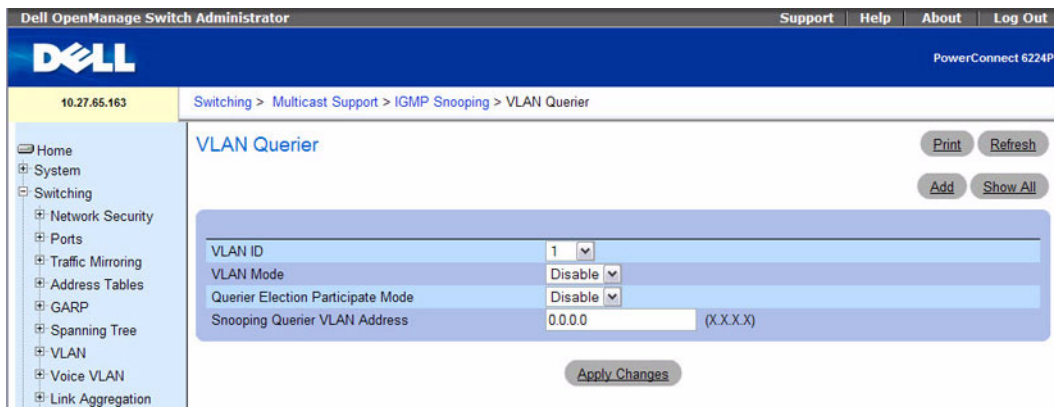

The **VLAN Querier** page contains the following fields:

- **VLAN ID** — Specifies the VLAN for the IGMP Snooping Querier configuration.
- **VLAN Mode** — Enables or disables the IGMP Snooping Querier on the VLAN selected in the VLAN ID field.
- **Querier Election Participate Mode** — Enables or disables the IGMP participation in election mode by the Snooping Querier. When this mode is disabled, upon seeing another querier of same version in the VLAN, the Snooping Querier transitions to non-querier state. When this mode is enabled, the Snooping Querier participates in querier election, where in the lowest IP address wins the querier election and operates as the querier in that VLAN. The other querier transitions to non-querier state.
- **Snooping Querier VLAN Address** — Specifies the Snooping Querier address to be used as source address in periodic IGMP queries sent on the specified VLAN.

Adding a New VLAN and Configuring its VLAN Querier Settings

1. Open the **VLAN Querier** page.
2. Click **Add**.

The page refreshes, and the **Add VLAN** page displays.

Figure 7-81. Add VLAN Querier

The screenshot shows a web interface for adding a VLAN. The title is "Add VLAN" and there are "Print" and "Refresh" buttons in the top right. The main form area has two input fields: "VLAN ID" with a range of "(2 to 4093)" and "VLAN Name" with a range of "(0 to 32 characters)". At the bottom of the form are "Apply Changes" and "Back" buttons.

3. Enter the VLAN ID and, if desired, an optional VLAN name.
4. Complete the fields on the page as needed.
5. Click **Apply Changes**.
The VLAN Querier settings are modified, and the device is updated.

Displaying the VLAN Querier Summary Table

1. Open the **VLAN Querier** page.
2. Click **Show All**.
The **VLAN Querier Summary Table** displays.

Figure 7-82. VLAN Querier Summary Table

VLAN Querier Summary Table Print Refresh

VLAN ID	VLAN Mode	Querier Election Participate Mode	Snooping Querier VLAN Address
1	Disable	Disable	0.0.0.0
3	Disable	Disable	0.0.0.0
10	Disable	Disable	0.0.0.0
20	Disable	Disable	0.0.0.0
30	Disable	Disable	0.0.0.0

Back

Configuring VLAN Querier Settings with CLI Commands

See "Configuring IGMP Snooping Querier Settings with CLI Commands" on page 404.

VLAN Querier Status

Use the **VLAN Querier Status** page to view the IGMP Snooping Querier settings for individual VLANs. To display the **VLAN Querier Status** page, click **Switching** → **Multicast Support** → **IGMP Snooping** → **VLAN Querier Status** in the tree view.

Figure 7-83. IGMP Snooping VLAN Querier Status

Dell OpenManage Switch Administrator Support Help About Log Out

PowerConnect 6224P

10.27.65.163 Switching > Multicast Support > IGMP Snooping > VLAN Querier Status

VLAN Querier Status Print Refresh

VLAN ID	VLAN Mode	Querier Election Participate Mode	Snooping Querier VLAN Address	Operational State	Operational Version	Last Querier Address	Last Querier Version	Operational Max Response Time(secs)
1	Disable	Disable	0.0.0.0	Disabled	2			
5	Disable	Disable	0.0.0.0	Disabled	2			
6	Disable	Disable	0.0.0.0	Disabled	2			
111	Disable	Disable	0.0.0.0	Disabled	2			
122	Disable	Disable	0.0.0.0	Disabled	2			
123	Disable	Disable	0.0.0.0	Disabled	2			
222	Disable	Disable	0.0.0.0	Disabled	2			
223	Disable	Disable	0.0.0.0	Disabled	2			

The **VLAN Querier Status** page contains the following fields:

- **VLAN ID** — Identifies the VLAN.
- **VLAN Mode** — Shows whether the IGMP Snooping Querier is enabled or disabled on the VLAN.

- **Querier Election Participate Mode** — Shows whether the mode is enabled or disabled. When this mode is disabled, upon seeing another querier of same version in the VLAN, the Snooping Querier transitions to non-querier state. When this mode is enabled, the Snooping Querier participates in querier election, where in the lowest IP address wins the querier election and operates as the querier in that VLAN. The other querier transitions to non-querier state.
- **Snooping Querier VLAN Address** — Identifies the Snooping Querier address to be used as source address in periodic IGMP queries sent on the VLAN.
- **Operational State** — Displays the operational state of the IGMP Snooping Querier on the specified VLAN. It can be in any of the following states:
 - **Querier** — The Snooping switch that is the Querier in the VLAN. The Snooping switch will send out periodic queries with a time interval equal to the configured querier Query Interval. If the Snooping switch sees a better querier in the VLAN, it transitions to non-querier mode.
 - **Non-Querier** — The Snooping switch is in Non-Querier mode in the VLAN. If the querier Expiry Interval timer expires, the Snooping switch will transition into querier mode.
 - **Disabled** — The Snooping Querier is not operational on the VLAN. The Snooping Querier transitions to disabled mode when 1) IGMP Snooping is not operational on the VLAN, 2) the querier address is not configured or 3) the network management address is not configured.
- **Operational Version** — Displays the operational IGMP protocol version of the querier.
- **Last Querier Address** — Displays the IP address of the last querier from which a query was snooped on the VLAN.
- **Last Querier Version** — Displays the IGMP protocol version of the last querier from which a query was snooped on the VLAN.
- **Operational Max Response Time** — Displays the maximum response time to be used in the queries that are sent by the Snooping Querier.

Viewing VLAN Querier Status with CLI Commands

See "Configuring IGMP Snooping Querier Settings with CLI Commands" on page 404.

MFDB IGMP Snooping Table

Use the **MFDB IGMP Snooping Table** page to view the MFDB IGMP Snooping Table and Forbidden Ports settings for individual VLANs.

To display the **MFDB IGMP Snooping Table** page, click **Switching** → **Multicast Support** → **IGMP Snooping** → **MFDB IGMP Snooping Table** in the tree view.

Figure 7-84. MFDB IGMP Snooping Table



The MFDB IGMP Snooping Table page contains the following fields:

- **VLAN** — Displays the VLAN ID associated with an IGMP group entry in the MFDB table.
- **MAC Address** — Displays the MAC Address associated with an IGMP group entry in the MFDB table.
- **Type** — Displays the type of the entry. **Static** entries are those that are configured by the user. **Dynamic** entries are added to the table as a result of a learning process or protocol.
- **Description** — The text description of this multicast table entry. Possible values are **Management Configured**, **Network Configured** and **Network Assisted**.
- **Ports** — The list of interfaces designated for forwarding (Fwd:) for a corresponding MFDB entry.

The **Forbidden Ports** section of the page contains the following fields:

- **VLAN** — Displays the VLAN ID associated with an IGMP group entry in the MFDB table.
- **MAC Address** — Displays the MAC Address associated with an IGMP group entry in the MFDB table.
- **Ports** — The list of interfaces that are designated for filtering (Flt:) for a corresponding MFDB entry.

Viewing the MFDB IGMP Snooping Table with CLI Commands

For information about the CLI commands that perform this function, see the following chapter in the CLI Reference Guide:

- IGMP Snooping Commands

The following table summarizes the equivalent CLI commands for this feature.

Table 7-44. MFDB IGMP Snooping Commands

CLI Command	Description
show ip igmp snooping groups	Displays the Multicast groups learned by IGMP snooping.

MRouter Status

Use the MRouter Status page to display the status of dynamically learned multicast router interfaces. To access this page, click **Switching** → **Multicast Support** → **MRouter Status** in the navigation tree.

Figure 7-85. MRouter Status

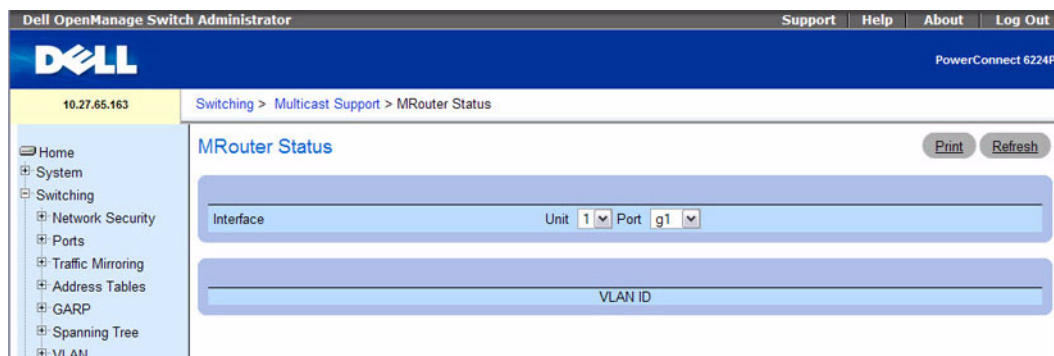

The MRouter Status page contains the following fields:

- **Interface** — Select the interface for which you want to display the status.
- **VLAN ID** — Displays the dynamically learned multicast router interfaces.

Viewing Mrouter Status with CLI Commands

For information about the CLI commands that perform this function, see the following chapter in the CLI Reference Guide:

- IGMP Snooping

The following table summarizes the equivalent CLI commands for this feature.

Table 7-45. Mrouter Status Command

CLI Command	Description
show ip igmp snooping mrouter	Displays information on dynamically learned Multicast router interfaces.

MLD Snooping

In IPv4, Layer 2 switches can use IGMP snooping to limit the flooding of multicast traffic by dynamically configuring Layer-2 interfaces so that multicast traffic is forwarded to only those interfaces associated with an IP multicast address. In IPv6, MLD snooping performs a similar function. With MLD snooping, IPv6 multicast data is selectively forwarded to a list of ports that want to receive the data instead of being flooded to all ports in a VLAN. This list is constructed by snooping IPv6 multicast control packets.

MLD is a protocol used by IPv6 multicast routers to discover the presence of multicast listeners (nodes wishing to receive IPv6 multicast packets) on its directly-attached links and to discover which multicast packets are of interest to neighboring nodes. MLD is derived from IGMP; MLD version 1 (MLDv1) is equivalent to IGMPv2, and MLD version 2 (MLDv2) is equivalent to IGMPv3. MLD is a subprotocol of Internet Control Message Protocol version 6 (ICMPv6), and MLD messages are a subset of ICMPv6 messages.

The switch can snoop on both MLDv1 and MLDv2 protocol packets and bridge IPv6 multicast data based on destination IPv6 multicast MAC addresses. The switch can be configured to perform MLD snooping and IGMP snooping simultaneously.

MLD Snooping General

Use the MLD Snooping **General** page to add MLD members.

To access this page, click **Switching** → **Multicast Support** → **MLD Snooping** → **General** in the navigation tree.

Figure 7-86. MLD Snooping General

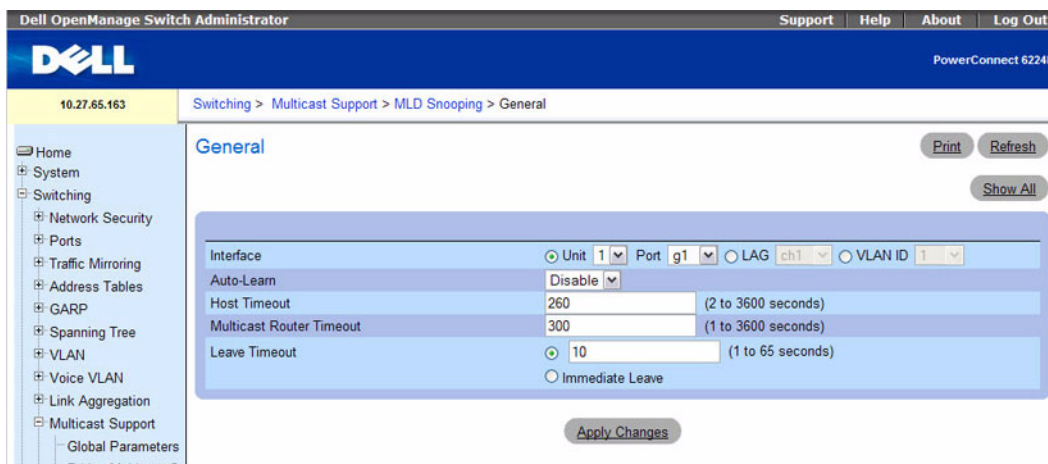

The MLD Snooping **General** page contains the following fields:

- **Interface** — Specifies the Unit and Port or the LAG on which MLD Snooping should be enabled.

- Auto Learn — Enable or Disable the ability of the switch to automatically learn about dynamic MLD ports.
- Host Timeout — Specifies time (in seconds) before an MLD snooping entry is aged out. The range is from 2 to 3600 seconds. The default time is 260 seconds.
- Multicast Router Timeout — Specifies time (in seconds) before aging out a Multicast router entry. The range is 1 to 3600 seconds. The default value is 300 seconds.
- Leave Timeout — Specifies the amount of time (in seconds) after a port leave message is received before the entry is aged out. Enter value for the timeout period, or click Immediate Leave to specify an immediate timeout. The range is from 1 to 3599 seconds. The default timeout is 10 seconds.

Displaying the MLD Snooping Table

1. Open the MLD Snooping General page.
2. Click Show All.

The MLD Snooping Table displays.

Figure 7-87. MLD Snooping Table

	Port	Auto Learn Enable	Host Timeout	Multicast Router Timeout	Leave Timeout	Copy To	Edit
1	1/1g1	Disable	260	0	10	<input checked="" type="checkbox"/>	<input type="checkbox"/>
2	1/1g2	Disable	260	0	10	<input checked="" type="checkbox"/>	<input type="checkbox"/>
3	1/1g3	Disable	260	0	10	<input checked="" type="checkbox"/>	<input type="checkbox"/>
4	1/1g4	Disable	260	0	10	<input checked="" type="checkbox"/>	<input type="checkbox"/>
5	1/1g5	Disable	260	0	10	<input checked="" type="checkbox"/>	<input type="checkbox"/>

Copying MLD Snooping Settings to Multiple Ports, LAGs, or VLANs

1. Open the General MLD snooping page.
2. Click Show All.
The MLD Snooping Table displays.
3. Click Copy Parameters From.
4. Select a Unit/Port, LAG, or VLAN to use as the source of the desired parameters.
5. Click Copy To for the Unit/Ports, LAGs, or VLANs that these parameters will be copied to.
6. Click Apply Changes.

The MLD Snooping settings are modified, and the device is updated.

Configuring MLD Snooping with CLI Commands

For information about the CLI commands that perform this function, see the following chapter in the CLI Reference Guide:

- IPv6 MLD Snooping Commands

The following table summarizes the equivalent CLI commands for this feature.

Table 7-46. MLD Snooping Commands

CLI Command	Description
ipv6 mld snooping immediate-leave	Enables or disables MLD Snooping immediate-leave admin mode on a selected interface or VLAN.
ipv6 mld snooping groupmembership-interval	Sets the MLD Group Membership Interval time on a VLAN or interface.
ipv6 mld snooping maxresponse	Sets the MLD Maximum Response time for an interface or VLAN.
ipv6 mld snooping mrcrtexpiretime	Sets the Multicast Router Present Expiration time.
ipv6 mld snooping (Global)	Enables MLD Snooping on the system (Global Config Mode).
ipv6 mld snooping (Interface)	Enables MLD Snooping on an interface.
ipv6 mld snooping (VLAN)	Enables MLD Snooping on a particular VLAN and all interfaces participating in that VLAN.
show ipv6 mld snooping	Displays MLD Snooping information.
show ipv6 mld snooping groups	Displays the MLD Snooping entries in the MFDB table.

MLD Snooping Global Querier Configuration

Use the MLD Snooping [Global Querier Configuration](#) page to configure the parameters for the MLD Snooping Querier.

To display the [Global Querier Configuration](#) page, click [Switching](#) → [Multicast Support](#) → [MLD Snooping](#) → [Global Querier Configuration](#) in the tree view.

Figure 7-88. MLD Snooping Global Querier Configuration

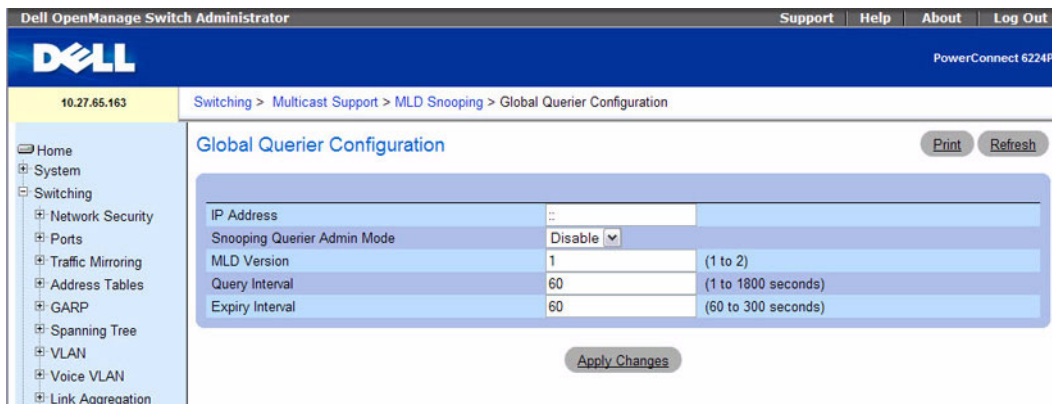

The MLD Snooping Global Querier Configuration page contains the following fields:

- **IP Address**— Specifies the Snooping Querier IPv6 Address which will be used as the source address in periodic MLD queries. This address is used when no address is configured for the VLAN on which the query is being sent.
- **Snooping Querier Admin Mode** — Enables or disables the administrative mode for MLD Snooping for the switch.
- **MLD Version** — Specifies the version of MLD protocol used in periodic MLD queries.
- **Query Interval (1–1800)** — Specifies the time interval in seconds between periodic queries sent by the Snooping Querier. The default value is 60.
- **Expiry Interval (60–300)** — Specifies the time interval in seconds after which the last querier information is removed. The default value is 60.

Configuring Global Querier MLD Snooping Settings with CLI Commands

For information about the CLI commands that perform this function, see the following chapter in the CLI Reference Guide:

- IPv6 MLD Snooping Querier Commands

The following table summarizes the equivalent CLI commands for this feature.

Table 7-47. MLD Snooping Querier Commands

CLI Command	Description
ipv6 mld snooping querier	Enables MLD Snooping Querier on the system or on a VLAN.
ipv6 mld snooping querier address	Sets the global MLD Snooping Querier address on the system or on a VLAN.
ipv6 mld snooping querier election participate	Enables the Snooping Querier to participate in the Querier Election process when it discovers the presence of another Querier in the VLAN.
ipv6 mld snooping querier query-interval	Sets the MLD Querier Query Interval time.
ipv6 mld snooping querier timer expiry	Sets the MLD Querier timer expiration period.
show ipv6 mld snooping querier	Displays MLD Snooping Querier information.
show ipv6 mld snooping groups	Displays the MLD Snooping entries in the MFDB table.

MLD Snooping VLAN Querier

Use the MLD Snooping VLAN Querier page to specify the MLD Snooping Querier settings for individual VLANs.

To display the MLD Snooping VLAN Querier page, click **Switching** → **Multicast Support** → **MLD Snooping** → **VLAN Querier** in the tree view.

Figure 7-89. MLD Snooping VLAN Querier

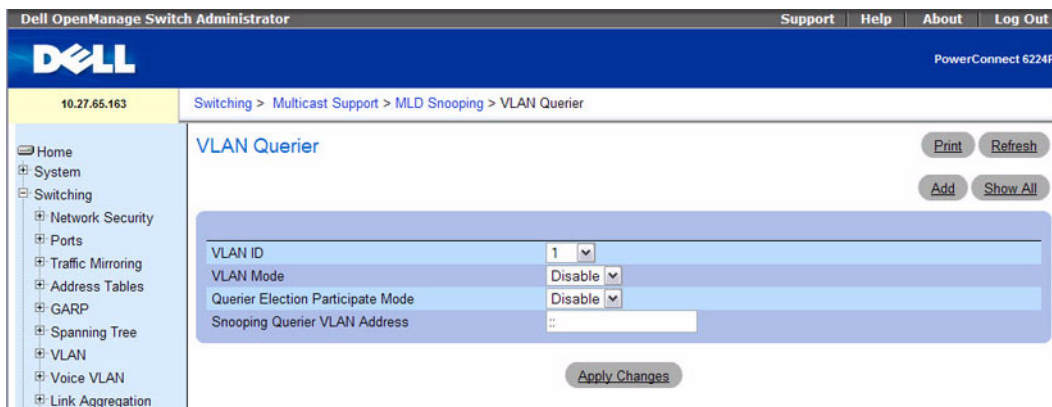

The MLD Snooping VLAN Querier page contains the following fields:

- **VLAN ID** — Specifies the VLAN for the MLD Snooping Querier configuration.

- **VLAN Mode** — Enables or disables the MLD Snooping Querier on the VLAN selected in the VLAN ID field.
- **Querier Election Participate Mode** — Enables or disables the MLD participation in election mode by the Snooping Querier. When this mode is disabled, upon seeing another querier of same version in the VLAN, the Snooping Querier transitions to non-querier state. When this mode is enabled, the Snooping Querier participates in querier election, where in the lowest IP address wins the querier election and operates as the querier in that VLAN. The other querier transitions to non-querier state.
- **Snooping Querier VLAN Address** — Specifies the Snooping Querier address to be used as source address in periodic MLD queries sent on the specified VLAN.

Adding a New VLAN and Configuring the VLAN Querier Settings

1. Open the MLD Snooping VLAN Querier page.
2. Click Add.

The page refreshes, and the Add VLAN page displays.

Figure 7-90. Add VLAN Querier

The screenshot shows a web form titled "Add VLAN". At the top right, there are "Print" and "Refresh" buttons. The form has two input fields: "VLAN ID" with a range of "(2 to 4093)" and "VLAN Name" with a range of "(0 to 32 characters)". Below the form are "Apply Changes" and "Back" buttons.

3. Enter the VLAN ID and, if desired, an optional VLAN name.
4. Complete the fields on the page as needed.
5. Click **Apply Changes**.
The VLAN Querier settings are modified, and the device is updated.

Displaying the MLD Snooping VLAN Querier Summary Table

1. Open the MLD Snooping VLAN Querier page.
2. Click Show All.

The VLAN Querier Summary Table displays.

Figure 7-91. VLAN Querier Summary Table

VLAN Querier Summary Table Print Refresh

VLAN ID	VLAN Mode	Querier Election Participate Mode	Snooping Querier VLAN Address
1	Disable	Disable	::
3	Disable	Disable	::
10	Disable	Disable	::
20	Disable	Disable	::
30	Disable	Disable	::

Back

Configuring VLAN Querier Settings with CLI Commands

See "Configuring IGMP Snooping Querier Settings with CLI Commands" on page 404.

FMLD Snooping VLAN Querier Status

Use the **VLAN Querier Status** page to view the MLD Snooping Querier settings for individual VLANs. To display the **VLAN Querier Status** page, click **Switching** → **Multicast Support** → **MLD Snooping** → **VLAN Querier Status** in the tree view.

Figure 7-92. MLD Snooping VLAN Querier Status

VLAN Querier Status Print Refresh

VLAN ID	VLAN Mode	Querier Election Participate Mode	Snooping Querier VLAN Address	Operational State	Operational Version	Last Querier Address	Last Querier Version	Operational Max Response Time(sec)
1	Disable	Disable	::	Disabled	1			
5	Disable	Disable	::	Disabled	1			
6	Disable	Disable	::	Disabled	1			
111	Disable	Disable	::	Disabled	1			
122	Disable	Disable	::	Disabled	1			
123	Disable	Disable	::	Disabled	1			
222	Disable	Disable	::	Disabled	1			
223	Disable	Disable	::	Disabled	1			

The MLD Snooping **VLAN Querier Status** page contains the following fields:

- **VLAN ID** — Identifies the VLAN.
- **VLAN Mode** — Shows whether the MLD Snooping Querier is enabled or disabled on the VLAN.

- **Querier Election Participate Mode** — Shows whether the mode is enabled or disabled. When this mode is disabled, upon seeing another querier of same version in the VLAN, the Snooping Querier transitions to non-querier state. When this mode is enabled, the Snooping Querier participates in querier election, where in the lowest IP address wins the querier election and operates as the querier in that VLAN. The other querier transitions to non-querier state.
- **Snooping Querier VLAN Address** — Identifies the Snooping Querier address to be used as source address in periodic MLD queries sent on the VLAN.
- **Operational State** — Displays the operational state of the MLD Snooping Querier on the specified VLAN. It can be in any of the following states:
 - **Querier** — The Snooping switch that is the Querier in the VLAN. The Snooping switch will send out periodic queries with a time interval equal to the configured querier Query Interval. If the Snooping switch sees a better querier in the VLAN, it transitions to non-querier mode.
 - **Non-Querier** — The Snooping switch is in Non-Querier mode in the VLAN. If the querier Expiry Interval timer expires, the Snooping switch will transition into querier mode.
 - **Disabled** — The Snooping Querier is not operational on the VLAN. The Snooping Querier transitions to disabled mode when 1) MLD Snooping is not operational on the VLAN, 2) the querier address is not configured or 3) the network management address is not configured.
- **Operational Version** — Displays the operational MLD protocol version of the querier.
- **Last Querier Address** — Displays the IP address of the last querier from which a query was snooped on the VLAN.
- **Last Querier Version** — Displays the MLD protocol version of the last querier from which a query was snooped on the VLAN.
- **Operational Max Response Time** — Displays the maximum response time to be used in the queries that are sent by the Snooping Querier.

Viewing VLAN Querier Status with CLI Commands

For information about the CLI commands that perform this function, see the following chapter in the CLI Reference Guide:

- IPv6 MLD Snooping Querier Commands

The following table summarizes the equivalent CLI commands for this feature.

Table 7-48. IPv6 Command

CLI Command	Description
show ipv6 mld snooping querier	Displays MLD Snooping Querier information.

MFDB MLD Snooping Table

Use the MFDB MLD Snooping Table page to view the MFDB MLD Snooping Table settings for individual VLANs.

To display the MFDB MLD Snooping Table page, click Switching → Multicast Support → MLD Snooping → MFDB MLD Snooping Table in the tree view.

Figure 7-93. MFDB MLD Snooping Table

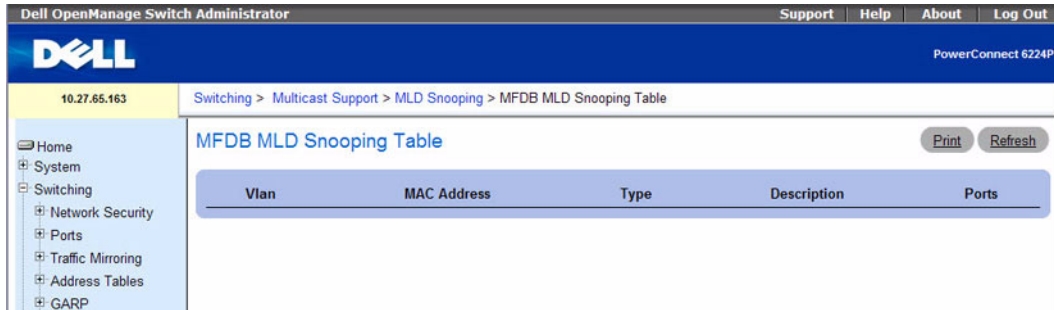

The MFDB MLD Snooping Table page contains the following fields:

- **VLAN** — Displays the VLAN ID associated with an MLD group entry in the MFDB table.
- **MAC Address** — Displays the MAC Address associated with an MLD group entry in the MFDB table.
- **Type** — Displays the type of entry. Static entries are those that are configured by the user. Dynamic entries are added to the table as a result of a learning process or protocol.
- **Description** — The text description of this multicast table entry. Possible values are **Management Configured**, **Network Configured** and **Network Assisted**.
- **Ports** — The list of interfaces that are designated for forwarding (Fwd:) for a corresponding MFDB entry.

Viewing the MFDB MLD Snooping Table with CLI Commands

For information about the CLI commands that perform this function, see the following chapter in the CLI Reference Guide:

- IPv6 MLD Snooping Querier Commands

The following table summarizes the equivalent CLI commands for this feature.

Table 7-49. MFDB MLD Snooping Commands

CLI Command	Description
show ipv6 mld snooping groups	Displays the MLD Snooping entries in the MFDB table.

Configuring the Link Layer Discovery Protocol (LLDP)

The IEEE 802.1AB defined standard, Link Layer Discovery Protocol (LLDP), allows stations residing on an 802 LAN to advertise major capabilities and physical descriptions. This information is viewed by a network manager to identify system topology and detect bad configurations on the LAN.

LLDP is a one-way protocol; there are no request/response sequences. Information is advertised by stations implementing the transmit function, and is received and processed by stations implementing the receive function. The transmit and receive functions can be enabled/disabled separately per port. By default, both transmit and receive are enabled on all ports. The application is responsible for starting each transmit and receive state machine appropriately, based on the configured status and operational state of the port.

The **LLDP** menu page contains links to the following features:

- [LLDP Configuration](#)
- [LLDP Statistics](#)
- [LLDP Connections](#)

LLDP Configuration

Use the **LLDP Configuration** page to specify LLDP parameters. Parameters that affect the entire system as well as those for a specific interface can be specified here.

To display the **LLDP Configuration** page, click **Switching** → **LLDP** → **LLDP Configuration** in the tree view.

Figure 7-94. LLDP Configuration

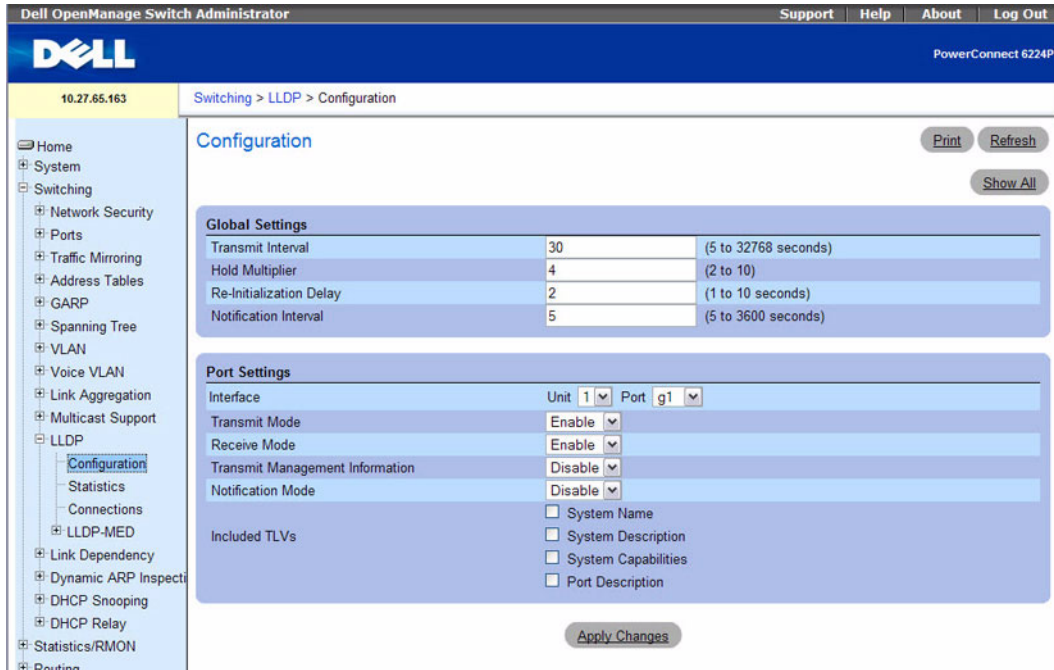

The LLDP Configuration page contains the following fields:

Global Settings

- **Transmit Interval (1–32768)** — Specifies the interval at which frames are transmitted. The default is 30 seconds.
- **Hold Multiplier (2–10)** — Specifies multiplier on the transmit interval to assign to TTL. Default is 4.
- **Re-Initialization Delay (1–10)** — Specifies delay before a re-initialization. Default is 2 seconds.
- **Notification Interval (5–3600)** — Limits the transmission of notifications. The default is 5 seconds.

Port Settings

- **Interface** — Specifies the port to be affected by these parameters.
- **Transmit Mode** — Enables or disables the transmit function. The default is disabled.
- **Receive Mode** — Enables or disables the receive function. The default is disabled.
- **Transmit Management Information** — Enables or disables transmission of management address instance. Default is disabled.
- **Notification Mode** — Enables or disables remote change notifications. The default is disabled.

- **Included TLVs** — Selects TLV information to transmit. Choices include System Name, System Capabilities, System Description, and Port Description.

Modifying the LLDP Configuration

1. Open the **LLDP Configuration** page.
2. Define the fields as needed.
3. Click **Apply Changes**.
LLDP parameters are saved to the switch.

Displaying the LLDP Interface Settings Table

1. Open the **LLDP Configuration** page.
2. Click **Show All**.
The **LLDP Interface Settings Table** displays.

Figure 7-95. LLDP Interface Settings Table

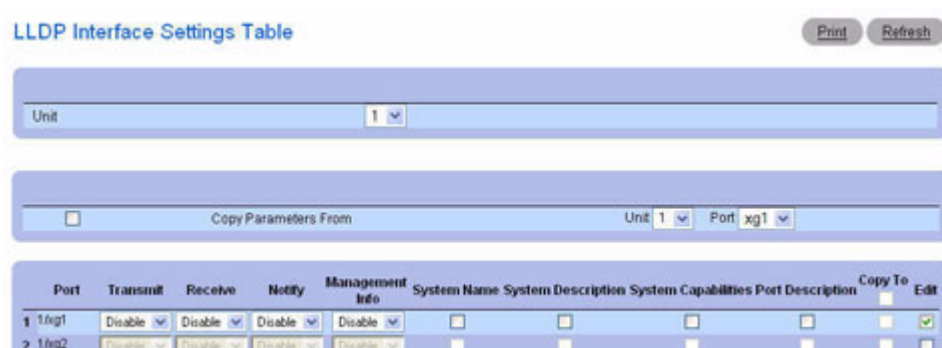

3. Use the **Unit** drop-down menu to view the **LLDP Interface Settings Table** for other units in the stack, if they exist.

Copying LLDP Interface Settings

1. Open the **LLDP Configuration** page.
2. Click **Show All**.
The **LLDP Interface Settings Table** displays.
3. Specify the **Unit** and **Port** you are copying from in **Copy Parameters From**.
4. Click **Copy To** for each **Unit/Port** to receive these parameters.
5. Click **Apply Changes**.
The LLDP Interface settings are copied, and the device is updated.

Modifying LLDP Interface Settings for Multiple Ports

1. Open the **LLDP Configuration** page.
2. Click **Show All**.
The **LLDP Interface Settings Table** displays.
3. Click **Edit** for each Unit/Port to modify.
4. Edit the LLDP Interface fields as needed.
5. Click **Apply Changes**.

The LLDP Interface settings are modified, and the device is updated.

Configuring LLDP with CLI Commands

For information about the CLI commands that perform this function, see the following chapter in the *CLI Reference Guide*:

- LLDP Commands

The following table summarizes the equivalent CLI commands for this feature.

Table 7-50. LLDP Commands

CLI Command	Description
lldp notification	Enables remote data change notifications.
lldp notification-interval	Limits how frequently remote data change notifications are sent.
lldp receive	Enables the LLDP receive capability.
lldp timers	Sets the timing parameters for local data transmission on ports enabled for LLDP.
lldp transmit	Enables the LLDP advertise capability.
lldp transmit-mgmt	Specifies that transmission of the local system management address information in the LLDPDUs is included.
lldp transmit-tlv	Specifies which optional TLVs in the 802.1AB basic management set will be transmitted in the LLDPDUs.
show lldp	Displays the current LLDP configuration summary.

LLDP Statistics

Use the LLDP Statistics page to view LLDP-related statistics.

To display the **LLDP Statistics** page, click **Switching →LLDP →LLDP Statistics** in the tree view.

Figure 7-96. LLDP Statistics

The screenshot displays the Dell OpenManage Switch Administrator interface. The top navigation bar includes 'Support', 'Help', 'About', and 'Log Out'. The main header shows the Dell logo and 'PowerConnect 6224P'. The breadcrumb trail indicates the current location: 'Switching > LLDP > Statistics'. A left-hand navigation menu lists various system and switching functions, with 'LLDP' expanded to show 'Configuration', 'Statistics', and 'Connections'. The 'Statistics' section is active, showing a 'Unit' dropdown set to '1'. Below this, a summary table lists 'Last Update' (0 Days 00:00:00) and counts for 'Total Inserts', 'Total Deletes', 'Total Drops', and 'Total Ageouts', all of which are zero. At the bottom, a detailed table provides statistics for three interfaces: 1/g1, 1/g2, and 1/g3. All metrics for these interfaces are zero.

Interface	Transmit Total	Receive Total	Discards	Errors	Ageouts	TLV Discards	TLV Unknowns
1/g1	0	0	0	0	0	0	0
1/g2	0	0	0	0	0	0	0
1/g3	0	0	0	0	0	0	0

The **LLDP Statistics** page displays the following statistics:

System-wide Statistics

- **Last Update** — Displays the value of system up time the last time a remote data entry was created, modified, or deleted.
- **Total Inserts** — Displays the number of times a complete set of information advertised by a remote switch has been inserted into the table.
- **Total Deletes** — Displays the number of times a complete set of information advertised by a remote switch has been deleted from the table.
- **Total Drops** — Displays the number of times a complete set of information advertised by a remote switch could not be inserted due to insufficient resources.
- **Total Ageouts** — Displays the number of times any remote data entry has been deleted due to TTL (Time-to-Live) expiration.

Port Statistics

- **Interface** — Displays the Unit and Port to which the statistics on that line apply.
- **Transmit Total** — Displays the total number of LLDP frames transmitted on the indicated port.
- **Receive Total** — Displays the total number of valid LLDP frames received on the indicated port.
- **Discards** — Displays the number of LLDP frames received on the indicated port and discarded for any reason.
- **Errors** — Displays the number of invalid LLDP frames received on the indicated port.
- **Ageouts** — Displays the number of times a remote data entry on the indicated port has been deleted due to TTL expiration.
- **TLV Discards** — Displays the number of LLDP TLVs (Type, Length, Value sets) received on the indicated port and discarded for any reason by the LLDP agent.
- **TLV Unknowns** — Displays the number of LLDP TLVs received on the indicated port for a type not recognized by the LLDP agent.

Use the **Unit** drop-down menu to view the **LLDP Statistics** for other units in the stack, if they exist.

Use the **Clear Statistics** button to reset all LLDP Statistics to zero.

Displaying LLDP Statistics with the CLI Command

For information about the CLI commands that perform this function, see the following chapter in the *CLI Reference Guide*:

- LLDP Commands

The following table summarizes the equivalent CLI commands for this feature.

Table 7-51. LLDP Statistics Commands

CLI Command	Description
show lldp statistics	Displays the current LLDP traffic statistics.
clear lldp statistics	Resets all LLDP statistics.

LLDP Connections

Use the **LLDP Connections** page to view the list of ports with LLDP enabled. Basic connection details are displayed.

To display the **LLDP Connections** page, click **Switching** → **LLDP** → **LLDP Connections** in the tree view.

Figure 7-97. LLDP Connections Table

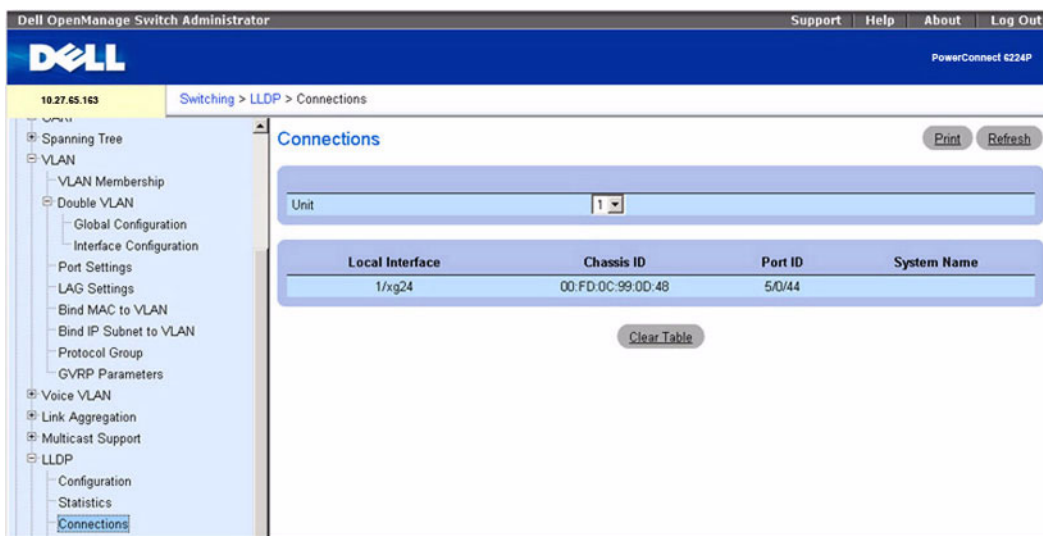

The **LLDP Connections** page displays the following port details:

- **Local Interface** — Designates a unit and port in the stack.
- **Chassis ID** — Identifies the 802 LAN device's chassis.
- **Port ID** — Identifies the port number from which the LLDPDU is transmitted.
- **System Name** — Identifies the system name associated with the remote device.

Use the **Unit** drop-down menu to view the **LLDP Connections** for other units in the stack, if they exist.

Use the **Clear Table** button to delete all information from the **LLDP Connections** table.

Viewing Details about the LLDP Connections

1. Open the LLDP Connections page.
2. Click the interface in the **Local Interface** field to view details about that device.
The LLDP Connections - Detailed page for the device displays.

Figure 7-98. Detailed LLDP Connections

The screenshot shows a web interface titled "LLDP Connections - Detailed". At the top right, there are "Print" and "Refresh" buttons. The main content is divided into two sections: "Local Interface" and "Remote".

Local Interface	
Local Interface	1/g11
TTL	68 (sec)

Remote	
Chassis ID Subtype	MAC Address
Chassis ID	00:FC:E3:90:01:4B
Port ID Subtype	MAC Address
Port ID	00:FC:E3:90:01:4D
Port Description	lldp_g4_dell_141
System Name	dell_141
System Description	LVL7 FASTPATH Routing
System Capabilities Supported	bridge, router
System Capabilities Enabled	bridge
Management Address	IPv4 - 10.254.24.141

At the bottom center, there is a "Back" button.

3. Use the **Back** button to return to the LLDP Connections page.

Viewing LLDP Connections with the CLI Command

For information about the CLI commands that perform this function, see the following chapter in the *CLI Reference Guide*:

- LLDP Commands

The following table summarizes the equivalent CLI commands for this feature.

Table 7-52. LLDP Connections Commands

CLI Command	Description
show lldp interface	Displays the current LLDP interface state.
show lldp local-device	Displays the LLDP local data
show lldp remote-device	Displays the LLDP remote data
clear lldp remote data	Deletes all data from the remote data table.

Configuring Link Layer Discovery Protocol (LLDP) for Media Endpoint Devices

The IEEE 802.1AB standard, which describes the Link Layer Discovery Protocol (LLDP), formalizes the discovery and capability retrieval of elements in a data network in a LAN/MAN environment. The information exchanged is stored in MIBs, and the information is accessible by a network management system (NMS) like SNMP. This framework is extensible and allows advanced utilization in areas like VoIP networks.

The Link Layer Discovery Protocol for Media Endpoint Devices (LLDP-MED) provides an extension to the LLDP standard for network configuration and policy, device location, Power over Ethernet management, and inventory management.

LLDP-MED uses LLDP's organizationally-specific TLV extensions and defines new TLVs that make it easier for a VoIP deployment in a wired or wireless LAN/MAN environment. It also makes mandatory a few optional TLVs from LLDP and recommends not transmitting some TLVs.

Since LLDP-MED uses the framework of LLDP, it is bound by the same requirements of the original specification. The frame format, restrictions and implications are all preserved.

The TLVs only communicate information; these TLVs do not automatically translate into configuration. An external application may query the MED MIB and take management actions in configuring functionality.

The **LLDP-MED** menu page contains links to the following features:

- LLDP Configuration
- LLDP-MED Interface Configuration
- LLDP-MED Local Device Information
- LLDP-MED Remote Device Information

LLDP-MED Global Configuration

Use the **LLDP-MED Global Configuration** page to change or view the LLDP-MED parameters that affect the entire system.

To display the LLDP-MED Global Configuration page, click Switching→LLDP →LLDP-MED →LLDP-MED Global Configuration in the tree view.

Figure 7-99. LLDP-MED Global Configuration

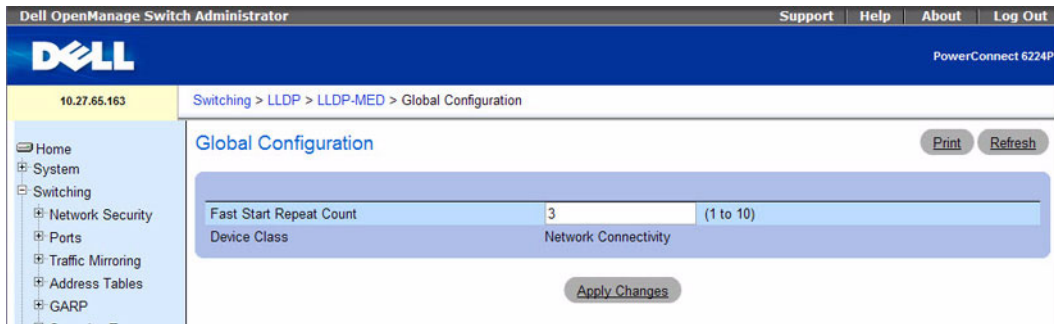

The LLDP-MED Global Configuration page contains the following fields:

- **Fast Start Repeat Count** — Specifies the number of LLDP PDUs that will be transmitted when the protocol is enabled. The range is from (1 to 10). Default value of fast repeat count is 4.
- **Device Class** — Specifies local device's MED Classification. There are four different kinds of devices, three of them represent the actual end points (classified as Class I Generic [IP Communication Controller etc.], Class II Media [Conference Bridge etc.], Class III Communication [IP Telephone etc.]). The fourth device is Network Connectivity Device, which is typically a LAN Switch/Router, IEEE 802.1 Bridge, IEEE 802.11 Wireless Access Point, and so on.

Modifying the LLDP-MED Global Configuration

1. Open the LLDP Configuration page.
2. Enter a new value for the Fast Start Repeat Count.
3. Click Apply Changes.

LLDP-MED parameters are saved to the switch.

Configuring LLDP-MED Global Settings with CLI Commands

For information about the CLI commands that perform this function, see the following chapter in the CLI Reference Guide:

- LLDP Commands

The following table summarizes the equivalent CLI commands for this feature.

Table 7-53. LLDP-MED Global Commands

CLI Command	Description
lldp med faststartrepeatcount	Sets the value of the fast start repeat count.
show lldp med	Displays a summary of the current LLDP MED configuration.
lldp med confignotification	Enables sending the topology change notifications.
lldp med transmit-tlv	Specifies which optional TLVs in the LLDP MED set are transmitted in the LLDPDUs.

LLDP-MED Interface Configuration

Use the **LLDP-MED Interface Configuration** page to specify LLDP-MED parameters that affect a specific interface.

To display the **LLDP-MED Interface Configuration** page, click **Switching** → **LLDP** → **LLDP-MED** → **LLDP-MED Interface Configuration** in the tree view.

Figure 7-100. LLDP-MED Interface Configuration

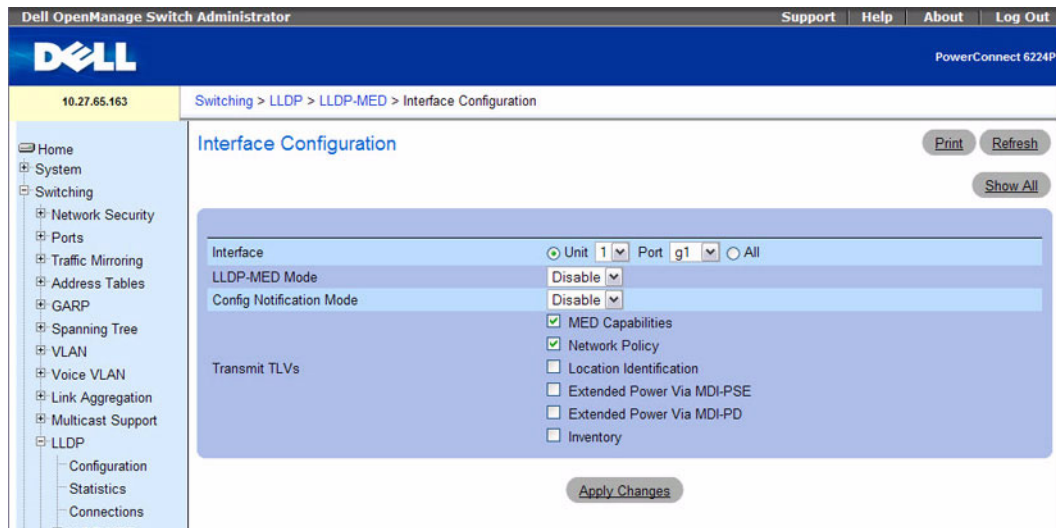

The **LLDP-MED Interface Configuration** page contains the following fields:

- **Interface** — Specifies the list of ports on which LLDP-MED - 802.1AB can be configured. Select the All option list to configure all interfaces on the system with the same LLDP-MED settings.
- **LLDP-MED Mode** — Specifies the Link Layer Data Protocol-Media End Point (LLDP-MED) mode for the selected interface. Enabling MED effectively enables the transmit and receive function of LLDP.

- **Config Notification Mode** — Specifies the LLDP-MED topology notification mode for the selected interface.
- **Transmit TLVs** — Specifies which optional type length values (TLVs) in the LLDP-MED will be transmitted in the LLDP PDU frames for the selected interface.
 - **MED Capabilities** — To transmit the capabilities TLV in LLDP frames.
 - **Network Policy** — To transmit the network policy TLV in LLDP frames.
 - **Location Identification** — To transmit the location TLV in LLDP frames.
 - **Extended Power via MDI - PSE** — To transmit the extended PSE TLV in LLDP frames.
 - **Extended Power via MDI - PD** — To transmit the extended PD TLV in LLDP frames.
 - **Inventory** — To transmit the inventory TLV in LLDP frames.

Modifying the LLDP-MED Interface Configuration

1. Open the **LLDP Configuration** page.
2. Specify the unit and select a port to configure, or select **All** to configure all ports with the same settings.
3. Configure the LLDP-MED settings for the interface or interfaces
4. Click **Apply Changes**.

LLDP-MED parameters are saved to the switch.



NOTE: If you configured **All** ports, the settings you applied will not display after the page updates. Select a specific interface or click **Show All** to view interface LLDP-MED settings.

Displaying the Interface Summary

1. Open the **LLDP-MED Interface Configuration** page.
2. Click **Show All**.

The **LLDP-MED Interface Summary** page displays and provides summary LLDP-MED information for all interfaces:

Figure 7-101. LLDP-MED Interface Summary

Configuring LLDP-MED Interface Settings with CLI Commands

For information about the CLI commands that perform this function, see the following chapter in the CLI Reference Guide:

- **LLDP Commands**

The following table summarizes the equivalent CLI commands for this feature.

Table 7-54. LLDP MED Interface Commands

CLI Command	Description
lldp med	Enables/disables LLDP-MED on an interface.
lldp med confignotification	Enables sending the topology change notification.
lldp med transmit-tlv	Specifies which optional TLVs in the LLDP MED set are transmitted in the LLDPDUs.
show lldp med interface	Displays a summary of the current LLDP MED configuration for a specific interface.

LLDP-MED Local Device Information

Use the **LLDP-MED Local Device Information** page to view the advertised LLDP local data for each port.

To display the **LLDP-MED Local Device Information** page, click **Switching**→**LLDP**→**LLDP-MED**→**LLDP-MED Local Device Information** in the tree view.

Figure 7-102. LLDP-MED Local Device Information

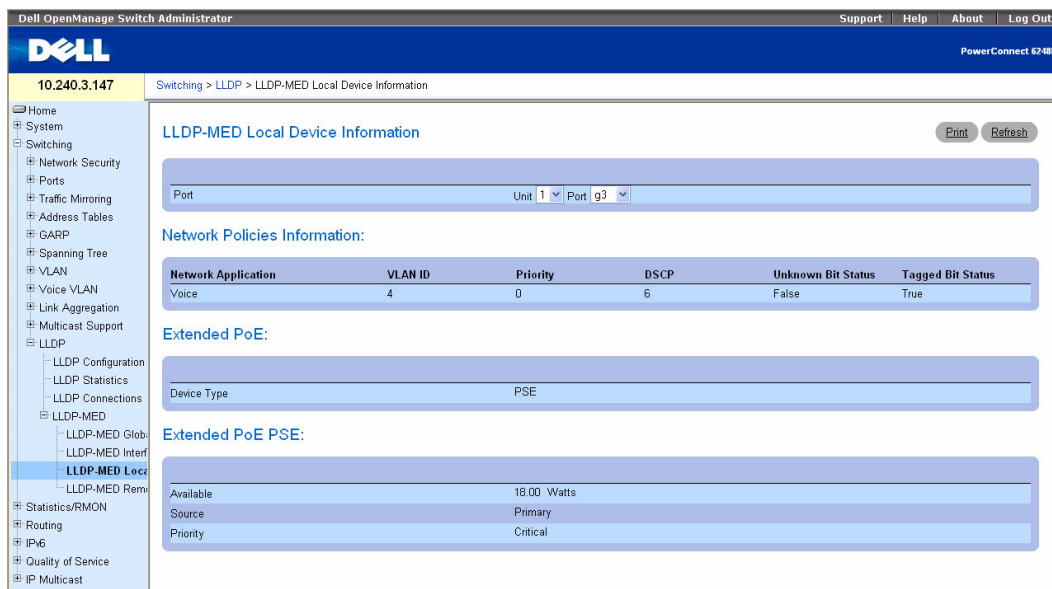

The **LLDP-MED Local Device Information** page contains the following fields:

- **Port** — Select the unit and port to display the LLDP local data advertised by the port. The port drop-down list contains only the ports with LLDP-MED enabled.

- **Network Policies Information** — If a network policy TLV is present in the LLDP frames, the following information displays:
 - **Network Application** — Specifies the type of media application the local device advertises in the policy. A port may receive one or more types, which include the following:
 - unknown
 - voicesignaling
 - guestvoice
 - guestvoicesignalling
 - softphonevoice
 - videoconferencing
 - streamingvideo
 - videosignalling
 - **Vlan Id** — Specifies the VLAN ID associated with a particular policy type.
 - **Priority** — Specifies the priority associated with a particular policy type.
 - **DSCP** — Specifies the DSCP associated with a particular policy type.
 - **Unknown Bit Status** — Specifies the unknown bit associated with a particular policy type.
 - **Tagged Bit Status** — Specifies the tagged bit associated with a particular policy type.
- **Inventory** — If an inventory TLV is present in LLDP frames, the following information displays:
 - **Hardware Revisions** — Specifies hardware version.
 - **Firmware Revisions** — Specifies Firmware version.
 - **Software Revisions** — Specifies Software version.
 - **Serial Number** — Specifies serial number.
 - **Manufacturer Name** — Specifies manufacturers name.
 - **Model Name** — Specifies model name.
 - **Asset ID** — Specifies asset id.
- **Location Information** — If a location TLV is present in LLDP frames, the following information displays:
 - **Sub Type** — Specifies type of location information.
 - **Location Information** — Specifies the location information as a string for given type of location id.
- **Extended PoE** — If the local device is a PoE device, the following information displays:
 - **Device Type** — Specifies power device type.
- **Extended PoE PSE** — If an extended PSE TLV is present in LLDP frame, the following information displays:

- **Available** — Specifies available power sourcing equipment's power value in tenths of watts on the port of local device.
- **Source** — Specifies power source of this port.
- **Priority** — Specifies PSE port power priority.
- **Extended PoE PD** — If an extended PD TLV is present in LLDP frame, the following information displays:
 - **Required** — Specifies required power device power value in tenths of watts on the port of local device.
 - **Source** — Specifies power source of this port.
 - **Priority** — Specifies PD port power priority.

Viewing LLDP-MED Local Device Information with CLI Commands

For information about the CLI commands that perform this function, see the following chapter in the CLI Reference Guide:

- LLDP Commands

The following table summarizes the equivalent CLI commands for this feature.

Table 7-55. LLDP-MED Local Device Information Command

CLI Command	Description
show lldp med local-device	Displays the advertised LLDP local data.

LLDP-MED Remote Device Information

Use the **LLDP-MED Remote Device Information** page to view the advertised LLDP data advertised by remote devices.

To display the **LLDP-MED Remote Device Information** page, click **Switching**→**LLDP**→**LLDP-MED**→**LLDP-MED Remote Device Information** in the tree view.

Figure 7-103. LLDP-MED Remote Device Information

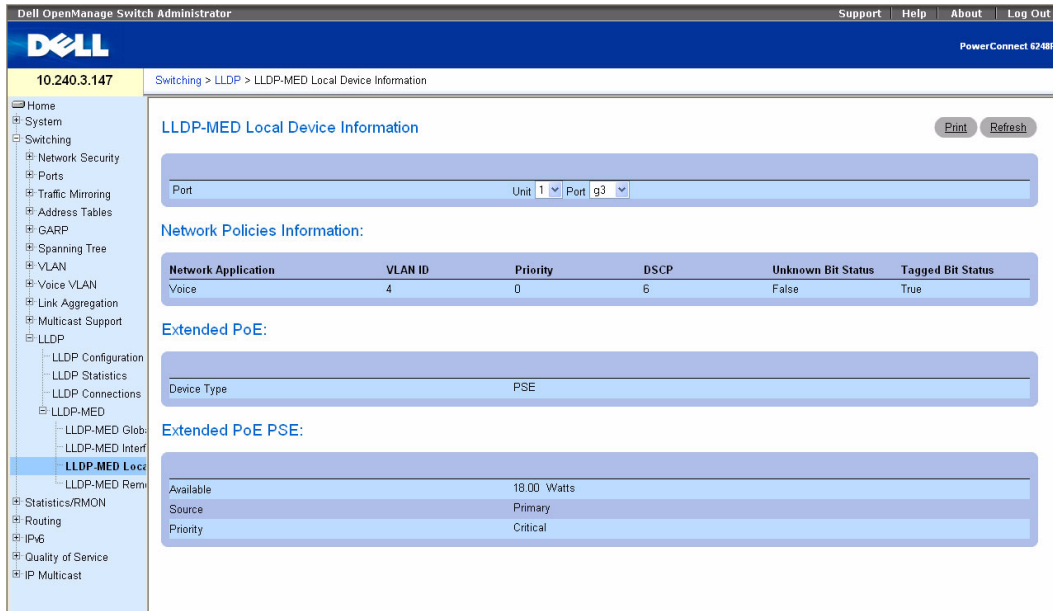

The LLDP-MED Remote Device Information page contains the following fields:

- **Local Interface** — Specifies the list of all the ports on which LLDP-MED is enabled.
- **Capability Information** — Specifies the supported and enabled capabilities that was received in MED TLV on this port.
 - **Supported Capabilities** — Specifies supported capabilities that was received in MED TLV on this port.
 - **Enabled Capabilities** — Specifies enabled capabilities that was received in MED TLV on this port.
 - **Device Class** — Specifies device class as advertised by the device remotely connected to the port.
- **Network Policy Information** — If a network policy TLV is received in the LLDP frames on this port, the following information displays:
 - **Network Application** — Specifies the type of media application that the local device advertises in the policy. A port may receive one or more application types, which include the following types:
 - unknown
 - voicesignaling
 - guestvoice
 - guestvoicesignalling

- softphonevoice
- videoconferencing
- streamingvideo
- videosignalling
- **Vlan Id** — Specifies the VLAN ID associated with a particular policy type.
- **Priority** — Specifies the priority associated with a particular policy type.
- **DSCP** — Specifies the DSCP associated with a particular policy type.
- **Unknown Bit Status** — Specifies the unknown bit associated with a particular policy type.
- **Tagged Bit Status** — Specifies the tagged bit associated with a particular policy type.
- **Inventory** — If an inventory TLV is present in LLDP frames, the following information displays:
 - **Hardware Revisions** — Specifies the hardware version of the remote device.
 - **Firmware Revisions** — Specifies the firmware version of the remote device.
 - **Software Revisions** — Specifies the software version of the remote device.
 - **Serial Number** — Specifies the serial number of the remote device.
 - **Manufacturer Name** — Specifies the manufacturer’s name of the remote device.
 - **Model Name** — Specifies the model name of the remote device.
 - **Asset ID** — Specifies the asset ID of the remote device.
- **Location Information** — If a location TLV is present in LLDP frames, the following information displays:
 - **Sub Type** — Specifies type of location information.
 - **Location Information** — Specifies the location information as a string for given type of location id.
- **Extended PoE** — Specifies if remote device is a PoE device.
 - **Device Type** — Specifies remote device's PoE device type connected to this port.
- **Extended PoE PSE** — If an extended PSE TLV is received in the LLDP frame on this port, the following information displays:
 - **Available** — Specifies the remote ports PSE power value in tenths of watts.
 - **Source** — Specifies the remote port’s PSE power source.
 - **Priority** — Specifies the remote ports PSE power priority.
- **Extended PoE PD** — If an extended PD TLV is received in the LLDP frame on this port, the following information displays:
 - **Required** — Specifies the remote port's PD power requirement.
 - **Source** — Specifies the remote port's power source.
 - **Priority** — Specifies the remote port's PD power priority.

Viewing LLDP-MED Remote Device Information with CLI Commands

For information about the CLI commands that perform this function, see the following chapter in the CLI Reference Guide:

- LLDP Commands

The following table summarizes the equivalent CLI commands for this feature.

Table 7-56. LLDP-MED Remote Device Information Commands

CLI Command	Description
show lldp med remote-device	Displays the current LLDP MED remote data.

Creating Link Dependencies

The link dependency feature provides the ability to enable or disable one or more ports based on the link state of one or more different ports. With link dependency enabled on a port, the link state of that port is dependent on the link state of another port. For example, if port A is dependent on port B and the switch detects a link loss on port B, the switch automatically brings down the link on port A. When the link is restored to port B, the switch automatically restores the link to port A.

You can create a maximum of 72 dependency groups. The ports participating in the Link Dependency can be across all the Stack Units (Manager/Member unit).

The Link Dependency feature supports the following scenarios:

- Port dependent on port — If a port loses the link, the switch brings down the link on another port.
- Port dependent on LAG — If all ports in a channel-group lose the link, the switch brings down the link on another port.
- LAG dependent on port — If a port loses the link, the switch brings down all links in a channel-group.
- Multiple port command — If a group of ports lose their link, the switch brings down the link on another group of ports.
- Overlapping ports — Overlapping ports on different groups will be brought down only if both dependent ports lose the link.

The **Link Dependency** menu page contains a link to the **Link Dependency Summary** page.

Link Dependency Summary

Use the **Link Dependency Summary** page to view all link dependencies on the system and to access the **Link Dependency Configuration** page. You can create a maximum of 16 dependency groups. The page displays the groups whether they have been configured or not.

To display the **Link Dependency Summary** page, click **Switching** → **Link Dependency** → **Link Dependency Summary** in the tree view.

Figure 7-104. Link Dependency Summary

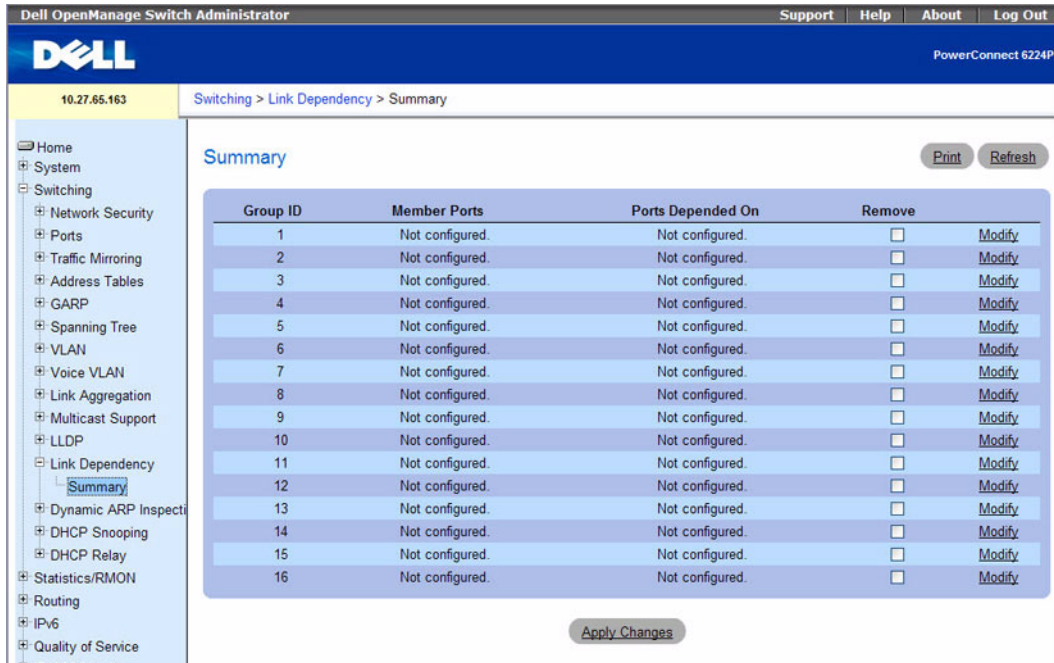

The Link Dependency Summary page contains the following fields:

- **Group ID** — The ID number of the group.
- **Member Ports** — The list of member ports belonging to the group.
- **Ports Depended On** — The list of ports upon which the group depends.
- **Remove** — A check box for removing the configuration for a group.
- **Modify** — A link for modifying the configuration of a group. Click the Modify link to access the configuration page for the group.

Modifying a Link Dependency Group

1. Open the Link Dependency Summary page.
2. From the Group ID row for the Link Dependency group to configure, click the **Modify** link. The Link Dependency Group Configuration page displays.

Figure 7-105. Link Dependency Group Configuration

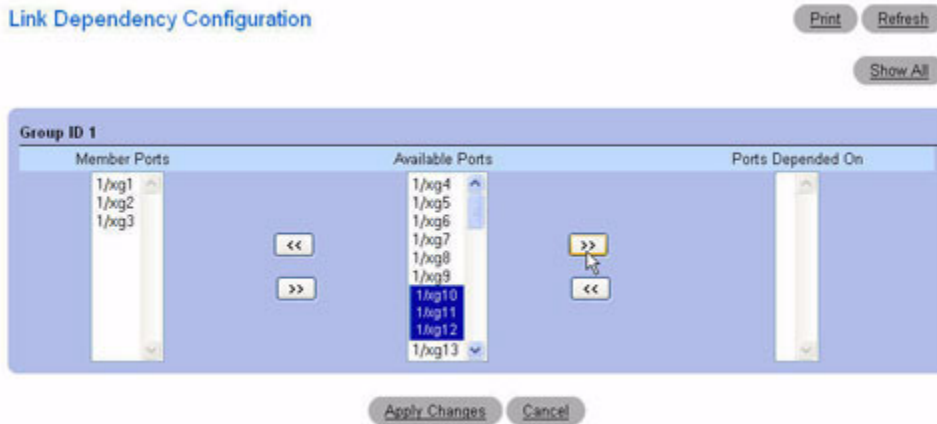

3. To add a port to the **Member Ports** column, click the port in the **Available Ports** column, and then click the << button to the left of the **Available Ports** column. Ctrl + click to select multiple ports.
4. To add a port to the **Ports Depended On** column, click the port in the **Available Ports** column, and then click the >> button to the right of the **Available Ports** column.
5. Click **Apply Changes**.

The Link Dependency settings for the group are modified, and the device is updated.

6. Click **Show All** to return to the **Link Dependency Summary** page.

Removing All Ports From a Link Dependency Group

1. Open the **Link Dependency Summary** page.
2. From the Group ID row for the Link Dependency group to remove, select the **Remove** check box.
3. Click **Apply Changes**.

The all ports are removed from the Link Dependency group, and the device is updated.

Configuring Link Dependency Groups With CLI Commands

For information about the CLI commands that perform this function, refer to the following chapter in the *CLI Reference Guide*:

- Link Dependency Commands

The following table summarizes the equivalent CLI commands for this feature.

Table 7-57. Link Dependency Commands

CLI Command	Description
link-dependency group	Enters the link-dependency mode to configure a link-dependency group.
add ethernet	Adds member Ethernet port(s) to the dependency list.
add port-channel	Adds member port-channels to the dependency list.
depends-on ethernet	Adds the dependent Ethernet ports list.
depends-on port-channel	Adds the dependent port-channels list.
show link-dependency	Shows the link dependencies configured on a particular group.

Dynamic ARP Inspection

Dynamic ARP Inspection (DAI) is a security feature that rejects invalid and malicious ARP packets. DAI prevents a class of man-in-the-middle attacks, where an unfriendly station intercepts traffic for other stations by poisoning the ARP caches of its unsuspecting neighbors. The miscreant sends ARP requests or responses mapping another station's IP address to its own MAC address.

DAI relies on DHCP snooping. DHCP snooping listens to DHCP message exchanges and builds a binding database of valid {MAC address, IP address, VLAN, and interface} tuples.

When DAI is enabled, the switch drops ARP packets whose sender MAC address and sender IP address do not match an entry in the DHCP snooping bindings database. You can optionally configure additional ARP packet validation.

The **Dynamic ARP Inspection** menu page contains links to the following features:

- DAI Global Configuration
- DAI Interface Configuration
- DAI VLAN Configuration
- DAI ACL Configuration
- DAI ACL Rule Configuration
- DAI Statistics

DAI Global Configuration

Use the DAI Configuration page to configure global DAI settings.

To display the DAI Configuration page, click **Switching → Dynamic ARP Inspection → Global Configuration** in the navigation tree.

Figure 7-106. Dynamic ARP Inspection Global Configuration

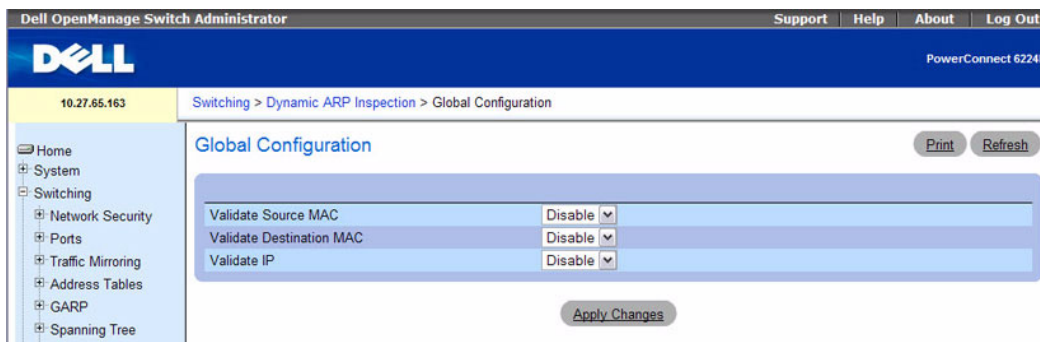

The Dynamic ARP Inspection Global Configuration page contains the following fields:

- **Validate Source MAC** — Select the DAI Source MAC Validation Mode for the switch. If you select Enable, Sender MAC validation for the ARP packets will be enabled. The default is Disable.
- **Validate Destination MAC**—Select the DAI Destination MAC Validation Mode for the switch. If you select Enable, Destination MAC validation for the ARP Response packets will be enabled. The default is Disable.
- **Validate IP**—Select the DAI IP Validation Mode for the switch. If you select Enable, IP Address validation for the ARP packets will be enabled. The default is Disable.

Configuring Dynamic ARP Inspection Global Settings With CLI Commands

For information about the CLI commands that perform this function, refer to the following chapter in the *CLI Reference Guide*:

- Dynamic ARP Inspection Commands

The following table summarizes the equivalent CLI commands for this feature.

Table 7-58. Dynamic ARP Inspection Global Commands

CLI Command	Description
ip arp inspection validate	Enables additional validation checks like source MAC address validation, destination MAC address validation or IP address validation on the received ARP packets.
show ip arp inspection	Displays the Dynamic ARP Inspection configuration on all the DAI enabled interfaces.

DAI Interface Configuration

Use the DAI Interface Configuration page to select the DAI Interface for which information is to be displayed or configured.

To display the DAI Interface Configuration page, click Switching → Dynamic ARP Inspection → DAI Interface Configuration in the navigation tree.

Figure 7-107. Dynamic ARP Inspection Interface Configuration

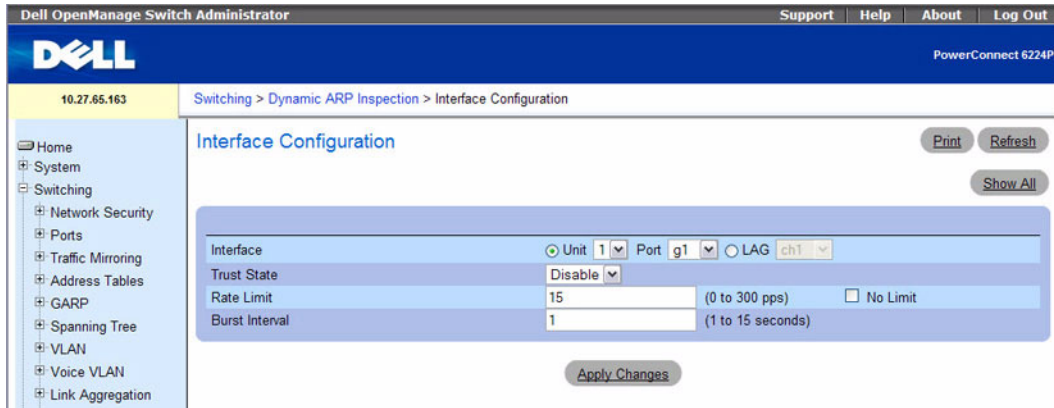

The Dynamic ARP Inspection Interface Configuration page contains the following fields:

- **Port**— Select the port or LAG for which data is to be displayed or configured.
- **Trust State** — Indicates whether the interface is trusted for Dynamic ARP Inspection. If you select Enable, the interface is trusted. ARP packets coming to this interface will be forwarded without checking. If you select Disable, the interface is not trusted. ARP packets coming to this interface will be subjected to ARP inspection. The default is Disable.
- **Rate Limit** — Specify the rate limit value for Dynamic ARP Inspection. If the incoming rate exceeds the Rate Limit value for consecutively burst interval seconds, ARP packets will be dropped. Use the corresponding check box to set No Limit. The default is 15 packets per second (pps).
- **Burst Interval** — Specify the burst interval for rate limiting on this interface. If the Rate Limit is None, then Burst Interval has no meaning and shows as N/A (Not Applicable). The default is 1 second.

Configuring Dynamic ARP Inspection Interfaces With CLI Commands

For information about the CLI commands that perform this function, refer to the following chapter in the *CLI Reference Guide*:

- Dynamic ARP Inspection Commands

The following table summarizes the equivalent CLI commands for this feature.

Table 7-59. Dynamic ARP Inspection Interface Commands

CLI Command	Description
ip arp inspection limit	Configures the rate limit and burst interval values for an interface.
ip arp inspection trust	Configures an interface as trusted for Dynamic ARP Inspection.
show ip arp inspection interfaces	Displays the Dynamic ARP Inspection configuration on all the DAI enabled interfaces.

DAI VLAN Configuration

Use the DAI VLAN Configuration page to select the DAI-capable VLANs for which information is to be displayed or configured.

To display the DAI VLAN Configuration page, click **Switching** → **Dynamic ARP Inspection** → **VLAN Configuration** in the navigation tree.

Figure 7-108. Dynamic ARP Inspection VLAN Configuration

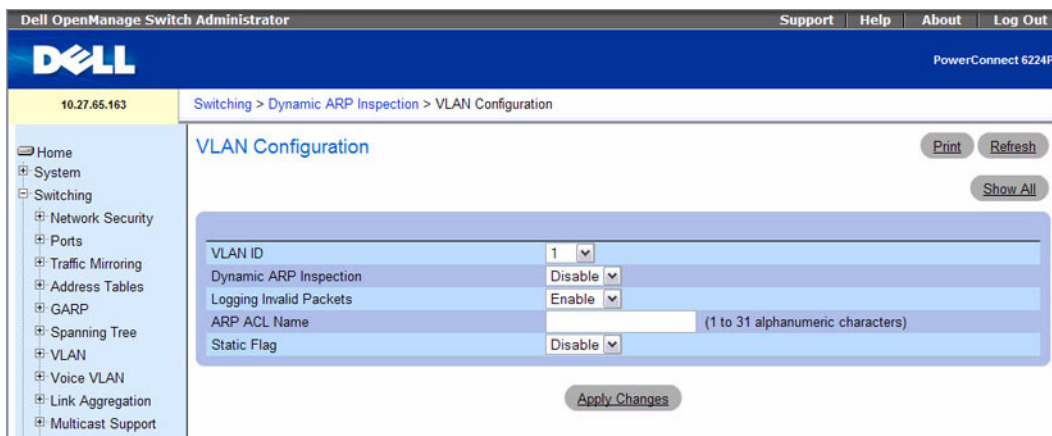

The Dynamic ARP Inspection VLAN Configuration page contains the following fields:

- **VLAN ID** — Select the VLAN ID for which information is to be displayed or configured.
- **Dynamic ARP Inspection** — Select whether Dynamic ARP Inspection is Enabled or Disabled on this VLAN. The default is Disable.
- **Logging Invalid Packets** — Select whether Dynamic ARP Inspection logging is Enabled or Disabled on this VLAN. The default is Disable.
- **ARP ACL Name** — The name of the ARP Access List. A VLAN can be configured to use this ARP ACL containing rules as the filter for ARP packet validation. The name can contain 1-31 alphanumeric characters.

- **Static Flag** — Use this flag to determine whether the ARP packet needs validation using the DHCP snooping database, in case the ARP ACL rules do not match. If Enabled, then the ARP Packet will be validated by the ARP ACL Rules only. If Disabled, then the ARP Packet needs further validation by using the DHCP Snooping entries. The default is Disable.

Configuring Dynamic ARP Inspection VLANs With CLI Commands

For information about the CLI commands that perform this function, refer to the following chapter in the *CLI Reference Guide*:

- Dynamic ARP Inspection Commands

The following table summarizes the equivalent CLI commands for this feature.

Table 7-60. Dynamic ARP Inspection VLAN Commands

CLI Command	Description
ip arp inspection filter	Configures the ARP ACL to be used for a single VLAN or a range of VLANs to filter invalid ARP packets.
ip arp inspection vlan	Enables Dynamic ARP Inspection on a single VLAN or a range of VLANs.
show ip arp inspection vlan	Displays the Dynamic ARP Inspection configuration on all the VLANs in the given VLAN range.

DAI ACL Configuration

Use the DAI ARP ACL Configuration page to add or remove DAI ARP ACLs.

To display the DAI ARP ACL Configuration page, click **Switching** → **Dynamic ARP Inspection** → **ACL Configuration** in the navigation tree.

Figure 7-109. Dynamic ARP Inspection ARP ACL Configuration

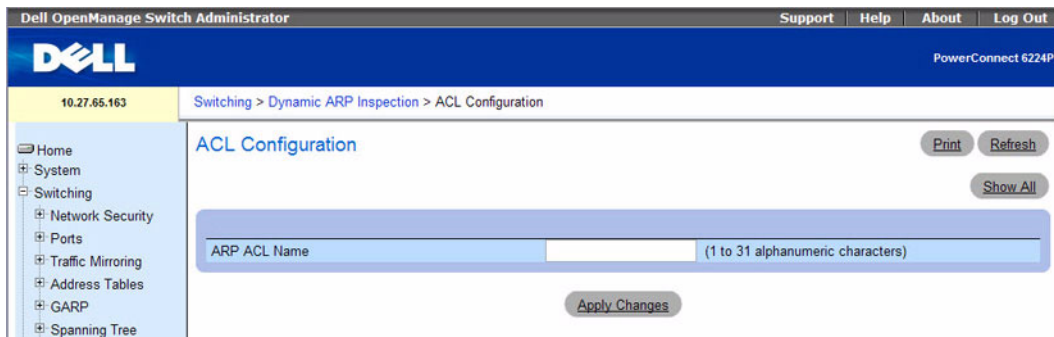

The Dynamic ARP Inspection ARP ACL Configuration page contains the following field:

- **ARP ACL Name** — Use this field to create a new ARP ACL for Dynamic ARP Inspection. The name can be 1 to 31 alphanumeric characters in length.

Displaying the DAI ACL Summary Table and Removing an Entry

1. Open the DAI ACL Configuration page.
2. Click Show All.

The Dynamic ARP Inspection ACL Summary table displays.

Figure 7-110. Dynamic ARP Inspection ACL Summary

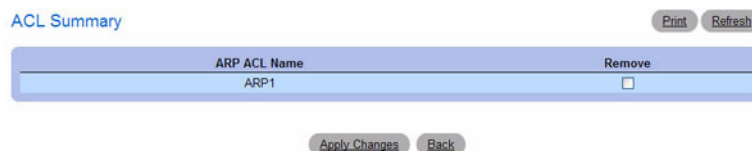

3. To remove an ARP ACL from the list, select the Remove option in the appropriate row, and then click Apply Changes.

Configuring Dynamic ARP Inspection DAI ACL With CLI Commands

For information about the CLI commands that perform this function, refer to the following chapter in the *CLI Reference Guide*:

- Dynamic ARP Inspection Commands

The following table summarizes the equivalent CLI commands for this feature.

Table 7-61. Dynamic ARP Inspection DAI ACL Commands

CLI Command	Description
arp access-list	Creates an ARP ACL.
show arp access-list	Displays the configured ARP ACLs with the rules.

DAI ACL Rule Configuration

Use the DAI ARP ACL Rule Configuration page to add or remove DAI ARP ACL Rules.

To display the DAI ARP ACL Rule Configuration page, click **Switching** → **Dynamic ARP Inspection** → **ACL Rule Configuration** in the navigation tree.

Figure 7-111. Dynamic ARP Inspection Rule Configuration

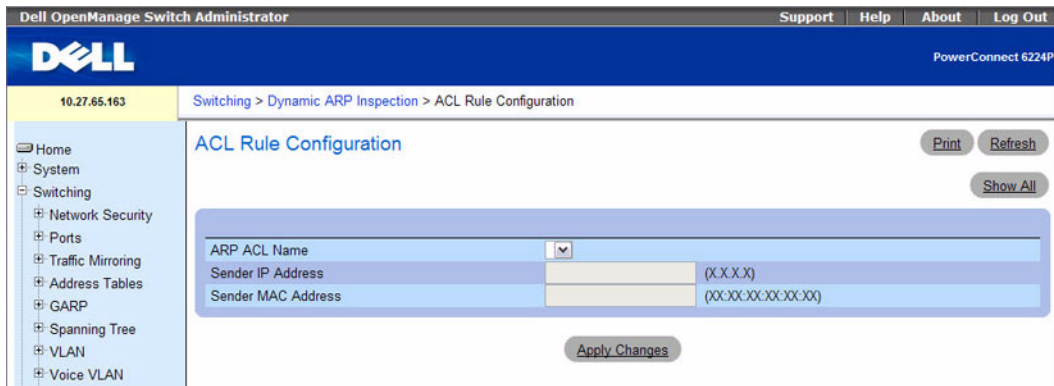

The Dynamic ARP Inspection Rule Configuration page contains the following fields:

- **ARP ACL Name** — Select the ARP ACL for which information is to be displayed or configured.
- **Sender IP Address** — To create a new rule for the selected ARP ACL, enter in this field the Sender IP Address match value for the ARP ACL.
- **Sender MAC Address** — To create a new rule for the selected ARP ACL, enter in this field the Sender MAC Address match value for the ARP ACL.

Displaying the DAI ACL Rule Summary Table

1. Open the DAI ACL Rule Configuration page.
2. Click Show All.

The Dynamic ARP Inspection ACL Rule Summary table displays.

Figure 7-112. Dynamic ARP Inspection Rule Summary

The screenshot shows the 'ACL Rule Summary' table. The table has four columns: 'ARPAcl', 'Sender IP Address', 'Sender MAC Address', and 'Remove'. A single row is displayed with the following data: 'ARP1', '192.168.4.34', '00:1C:23:55:39:8E', and a checkbox. Above the table are 'Print' and 'Refresh' buttons. Below the table are 'Apply Changes' and 'Back' buttons.

ARPAcl	Sender IP Address	Sender MAC Address	Remove
ARP1	192.168.4.34	00:1C:23:55:39:8E	<input type="checkbox"/>

Configuring Dynamic ARP Inspection Rule With CLI Commands

For information about the CLI commands that perform this function, refer to the following chapter in the *CLI Reference Guide*:

- Dynamic ARP Inspection Commands

The following table summarizes the equivalent CLI commands for this feature.

Table 7-62. Dynamic ARP Inspection Rule Command

CLI Command	Description
permit ip host mac host	Configures a rule for a valid IP address and MAC address combination used in ARP packet validation.

DAI Statistics

Use the DAI Statistics page to display the statistics per VLAN.

To display the DAI Statistics page, click **Switching** → **Dynamic ARP Inspection** → **Statistics** in the navigation tree.

Figure 7-113. Dynamic ARP Inspection Statistics

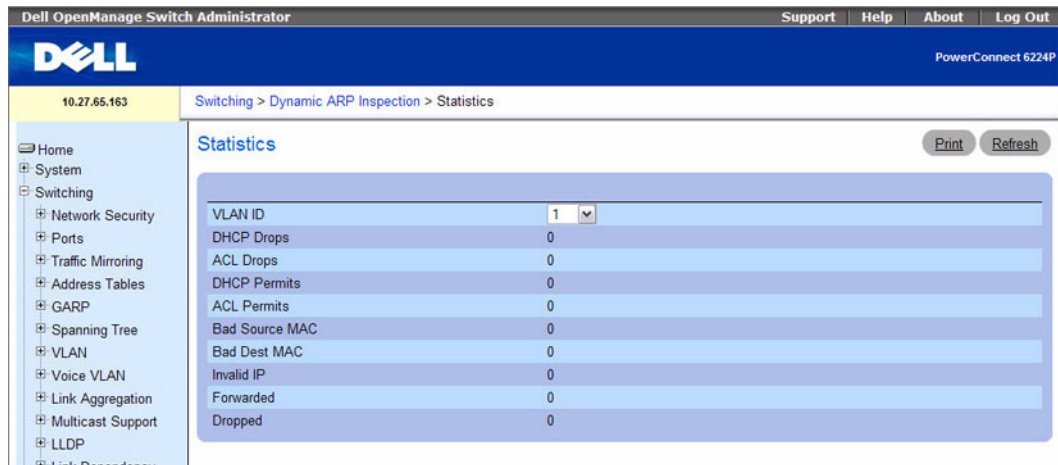

The **Dynamic ARP Inspection Statistics** page contains the following fields:

- **VLAN ID** — Select the DAI-enabled VLAN ID for which to display statistics.
- **DHCP Drops** — The number of ARP packets that were dropped by DAI because there was no matching DHCP snooping binding entry found.
- **ACL Drops** — The number of ARP packets that were dropped by DAI because there was no matching ARP ACL rule found for this VLAN and the static flag is set on this VLAN.
- **DHCP Permits** — The number of ARP packets that were forwarded by DAI because there was a matching DHCP snooping binding entry found.
- **ACL Permits** — The number of ARP packets that were permitted by DAI because there was a matching ARP ACL rule found for this VLAN.

- **Bad Source MAC** — The number of ARP packets that were dropped by DAI because the sender MAC address in the ARP packet did not match the source MAC in the Ethernet header.
- **Bad Dest MAC** — The number of ARP packets that were dropped by DAI because the target MAC address in the ARP reply packet did not match the destination MAC in the Ethernet header.
- **Invalid IP** — The number of ARP packets dropped by DAI because the sender IP address in the ARP packet or target IP address in the ARP reply packet is not valid. Invalid addresses include 0.0.0.0, 255.255.255.255, IP multicast addresses, class E addresses (240.0.0.0/4), and loopback addresses (127.0.0.0/8).
- **Forwarded** — The number of valid ARP packets forwarded by DAI.
- **Dropped** — The number of not valid ARP packets dropped by DAI.

Viewing Dynamic ARP Inspection Statistics With CLI Commands

For information about the CLI commands that perform this function, refer to the following chapter in the *CLI Reference Guide*:

- Dynamic ARP Inspection Commands

The following table summarizes the equivalent CLI commands for this feature.

Table 7-63. Dynamic ARP Inspection Command

CLI Command	Description
show ip arp inspection statistics	Displays the statistics of the ARP packets processed by Dynamic ARP Inspection.
clear counters ip arp inspection	Resets the statistics for Dynamic ARP Inspection on all VLANs.

DHCP Snooping

DHCP snooping is a security feature that monitors DHCP messages between a DHCP client and DHCP servers to filter harmful DHCP messages and to build a bindings database of MAC address, IP address, VLAN ID, and port tuples that are considered authorized. You can enable DHCP snooping globally, per-interface, and on specific VLANs, and configure ports within the VLAN to be trusted or untrusted. DHCP servers must be reached through trusted ports.

DHCP snooping enforces the following security rules:

- DHCP packets from a DHCP server (DHCP OFFER, DHCP ACK, DHCP NAK, DHCP RELEASE/QUERY) are dropped if received on an untrusted port.
- DHCP RELEASE and DHCP DECLINE messages are dropped if for a MAC address in the snooping database, but the binding's interface is other than the interface where the message was received.
- On untrusted interfaces, the switch drops DHCP packets whose source MAC address does not match the client hardware address. This feature is a configurable option.

The hardware identifies all incoming DHCP packets on ports where DHCP snooping is enabled. DHCP snooping is enabled on a port if (a) DHCP snooping is enabled globally, and (b) the port is a member of a VLAN where DHCP snooping is enabled. On untrusted ports, the hardware traps all incoming DHCP packets to the CPU. On trusted ports, the hardware forwards client messages and copies server messages to the CPU so that DHCP snooping can learn the binding.

Table 7-64. DHCP Snooping

	Destination UDP Port 67 (from client)	Destination UDP Port 68 (from server)
Trusted Port	Forward in hardware	Copy to CPU (Complete the tentative binding for a given DHCP client, based on the MAC address.)
Untrusted Port	Trap to CPU (enforcement)	Trap to CPU (error logging)

To display the **DHCP Snooping** page, click **Switching** → **DHCP Snooping** in the tree view.

The **DHCP Snooping** menu page contains links to the following features:

- DHCP Snooping Configuration
- DHCP Snooping Interface Configuration
- DHCP Snooping VLAN Configuration
- DHCP Snooping Persistent Configuration
- DHCP Snooping Static Bindings Configuration
- DHCP Snooping Dynamic Bindings Summary
- DHCP Snooping Statistics

DHCP Snooping Configuration

Use the DHCP Snooping Configuration page to control the DHCP Snooping mode on the switch and to specify whether the sender MAC Address for DHCP Snooping must be validated.

To access the DHCP Snooping Configuration page, click **Switching** → **DHCP Snooping** → **Global Configuration** in the navigation tree.

Figure 7-114. DHCP Snooping Configuration

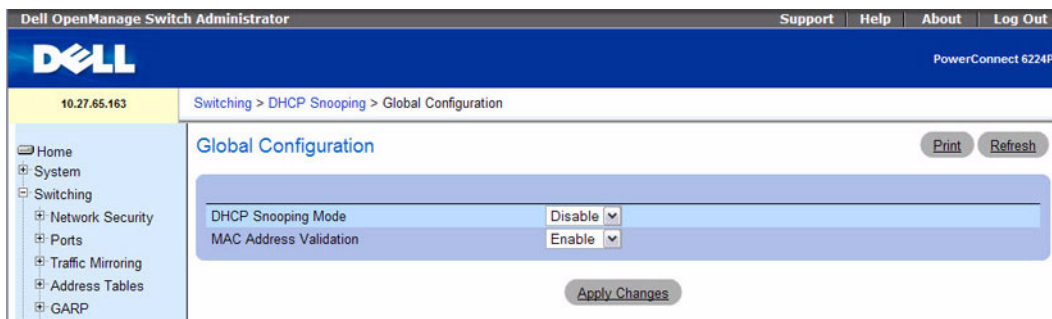

The DHCP Snooping Configuration page contains the following fields:

- **DHCP Snooping Mode** — Enables or disables the DHCP Snooping feature. The default is Disable.
- **MAC Address Validation** — Enables or disables the validation of sender MAC Address for DHCP Snooping. The default is Enable.

Configuring DHCP Snooping With CLI Commands

For information about the CLI commands that perform this function, refer to the following chapter in the *CLI Reference Guide*:

- DHCP Snooping Commands

The following table summarizes the equivalent CLI commands for this feature.

Table 7-65. DHCP Snooping Configuration Commands

CLI Command	Description
ip dhcp snooping	Enables DHCP snooping globally or on a specific VLAN.
ip dhcp snooping verify mac-address	Enables the verification of the source MAC address with the client MAC address in the received DHCP message.
show ip dhcp snooping	Displays the DHCP snooping global and per port configuration.

DHCP Snooping Interface Configuration

Use the **DHCP Snooping Interface Configuration** page to configure the DHCP Snooping settings on individual interfaces.

The hardware rate limits DHCP packets sent to the CPU from untrusted interfaces to 64 Kbps. There is no hardware rate limiting on trusted interfaces.

To prevent DHCP packets from being used as a DoS attack when DHCP snooping is enabled, the snooping application enforces a rate limit for DHCP packets received on untrusted interfaces. DHCP snooping monitors the receive rate on each interface separately. If the receive rate exceeds the configuration limit, DHCP snooping brings down the interface. The port must be administratively enabled from the **Switching → Ports → Port Configuration** page (or the `no shutdown` CLI command) to further work with the port. You can configure both the rate and the burst interval.

The DHCP snooping application processes incoming DHCP messages. For DHCPRELEASE and DHCPDECLINE messages, the application compares the receive interface and VLAN with the client's interface and VLAN in the binding database. If the interfaces do not match, the application logs the event and drops the message. For valid client messages, DHCP snooping compares the source MAC address to the DHCP client hardware address. Where there is a mismatch, DHCP snooping logs and drops the packet. You can disable this feature using the **DHCP Snooping Interface Configuration** page or by using the `no ip dhcp snooping verify mac-address` command. DHCP snooping forwards valid client messages on trusted members within the VLAN. If DHCP relay and/or DHCP server co-exist with the DHCP snooping, the DHCP client message will be sent to the DHCP relay and/or DHCP server to process further.

To access the **DHCP Snooping Interface Configuration** page, click **Switching → DHCP Snooping → Interface Configuration** in the navigation tree.

Figure 7-115. DHCP Snooping Interface Configuration

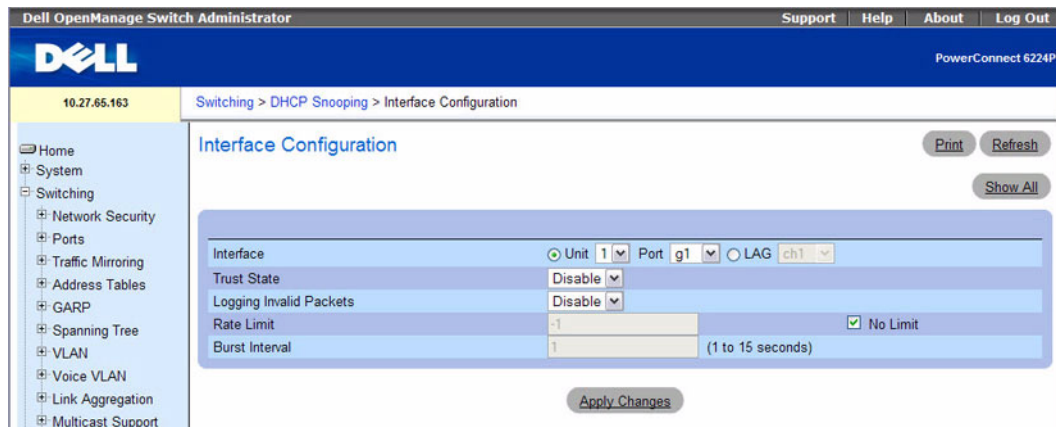

The **DHCP Snooping Interface Configuration** page contains the following fields:

- **Port** — Select the interface for which data is to be displayed or configured.
- **Trust State** — If it is enabled, the DHCP snooping application considers the port as trusted. The default is Disable.

- **Logging Invalid Packets** — If it is enabled, the DHCP snooping application logs invalid packets on this interface. The default is Disable.
- **Rate Limit** — Specifies the rate limit value for DHCP snooping purposes. If the incoming rate of DHCP packets exceeds the value of this object for consecutively burst interval seconds, the port will be shutdown. If this value is None, there is no limit. The default is 15 packets per second (pps). The Rate Limit range is 0 to 300.
- **No Limit** — Specifies the value of Rate Limit which is -1. If the rate limit is -1, burst interval has no meaning and is therefore disabled.
- **Burst Interval** — Specifies the burst interval value for rate limiting purposes on this interface. If the rate limit is None, the burst interval has no meaning and displays it as “N/A”. The default is 1 second. The Burst Interval range is 1 to 15.

Displaying the DHCP Snooping Interface Summary Table

1. Open the DHCP Snooping Interface Configuration page.
2. Click Show All.

The DHCP Snooping Interface Summary table displays.

Figure 7-116. DHCP Snooping Interface Summary

Interface	Trust State	Logging Invalid Packets	Rate Limit	Burst Interval
1/g1	Disable	Disable	15	1
1/g2	Disable	Disable	15	1
1/g3	Disable	Disable	15	1
1/g4	Disable	Disable	15	1
1/g5	Disable	Disable	15	1
1/g6	Disable	Disable	15	1
1/g7	Disable	Disable	15	1
1/g8	Disable	Disable	15	1
1/g9	Disable	Disable	15	1
1/g10	Disable	Disable	15	1
1/g11	Disable	Disable	15	1
1/g12	Disable	Disable	15	1

Configuring DHCP Snooping Interfaces With CLI Commands

For information about the CLI commands that perform this function, refer to the following chapter in the *CLI Reference Guide*:

- DHCP Snooping Commands

The following table summarizes the equivalent CLI commands for this feature.

Table 7-66. DHCP Snooping Interface Configuration Commands

CLI Command	Description
ip dhcp snooping limit	Controls the maximum rate of DHCP messages.
ip dhcp snooping log-invalid	Enables logging of DHCP messages filtered by the DHCP Snooping application.
ip dhcp snooping trust	Configure a port as trusted for DHCP snooping.
show ip dhcp snooping interfaces	Displays the DHCP Snooping status of the interfaces.

DHCP Snooping VLAN Configuration

The DHCP snooping application does not forward server messages because they are forwarded in hardware.

DHCP snooping forwards valid DHCP client messages received on non-routing VLANs. The message is forwarded on all trusted interfaces in the VLAN.

DHCP snooping can be configured on switching VLANs and routing VLANs. When a DHCP packet is received on a routing VLAN, the DHCP snooping application applies its filtering rules and updates the bindings database. If a client message passes filtering rules, the message is placed into the software forwarding path, where it may be processed by the DHCP relay agent, the local DHCP server, or forwarded as an IP packet.

DHCP snooping is disabled globally and on all VLANs by default. Ports are untrusted by default.

To access the DHCP Snooping VLAN Configuration page, click **Switching** → **DHCP Snooping** → **VLAN Configuration** in the navigation tree.

Figure 7-117. DHCP Snooping VLAN Configuration

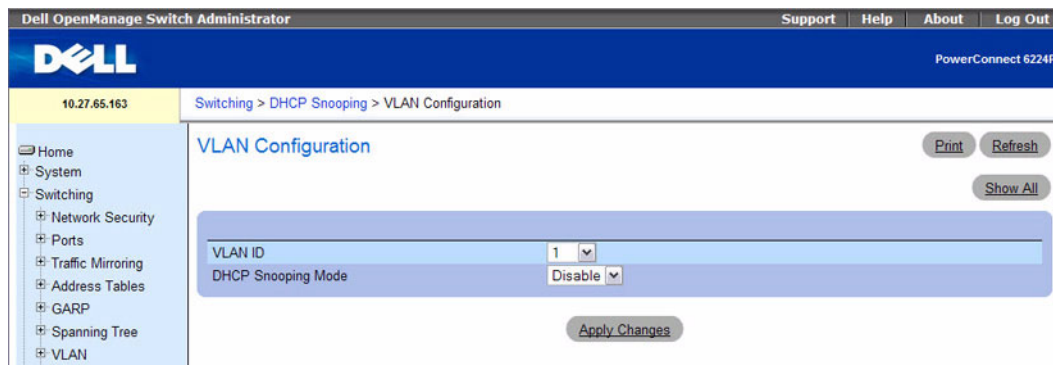

The DHCP Snooping VLAN Configuration page contains the following fields:

- **VLAN ID** — Select the VLAN for which information to be displayed or configured for the DHCP snooping application.
- **DHCP Snooping Mode** — Enables or disables the DHCP snooping feature on the selected VLAN. The default is Disable.

Displaying the DHCP Snooping VLAN Summary Table

1. Open the DHCP Snooping VLAN Configuration page.
2. Click Show All.

The DHCP Snooping VLAN Summary table displays.

Figure 7-118. DHCP Snooping VLAN Summary

VLAN ID	DHCP Snooping Mode
1	Disable
2	Disable
3	Disable
4	Disable
5	Disable
6	Disable
7	Disable
8	Disable
9	Disable
10	Disable
11	Disable

Configuring DHCP Snooping VLANs With CLI Commands

For information about the CLI commands that perform this function, refer to the following chapter in the *CLI Reference Guide*:

- DHCP Snooping Commands

The following table summarizes the equivalent CLI commands for this feature.

Table 7-67. DHCP Snooping VLAN Commands

CLI Command	Description
ip dhcp snooping	Enables DHCP snooping globally or on a specific VLAN.

DHCP Snooping Persistent Configuration

Use the **DHCP Snooping Persistent Configuration** page to configure the persistent location of the DHCP snooping database. This location can be local or remote on a given IP machine. For more information about DHCP bindings and the DHCP Snooping database, see "DHCP Snooping Static Bindings Configuration" on page 456.

To access the **DHCP Snooping Persistent Configuration** page, click **Switching** → **DHCP Snooping** → **Persistent Configuration** in the navigation tree.

Figure 7-119. DHCP Snooping Persistent Configuration

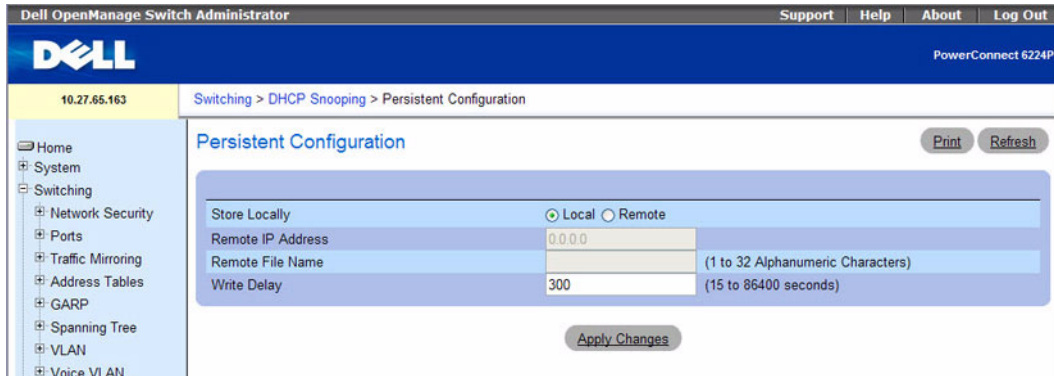

The DHCP Snooping Persistent Configuration page contains the following fields:

- **Store Locally** — Choose whether to store the DHCP snooping database locally in flash or on a remote system:
 - **Local** — Select the Local check box to store the DHCP binding database in the flash memory on the switch.
 - **Remote** — Check the Remote check box to store the DHCP binding database on a remote server.
- **Remote IP Address** — Enter the Remote IP address on which the snooping database will be stored when the Remote check box is selected.
- **Remote File Name** — Enter the Remote filename to store the database when the Remote check box is selected.
- **Write Delay** — Enter the maximum write time to write the database into the local or remote location. The write delay range is 15 to 86400 seconds.

Configuring the DHCP Snooping Persistent Database With CLI Commands

For information about the CLI commands that perform this function, refer to the following chapter in the *CLI Reference Guide*:

- DHCP Snooping Commands

The following table summarizes the equivalent CLI commands for this feature.

Table 7-68. DHCP Snooping Persistent Database Commands

CLI Command	Description
ip dhcp snooping database	Configures the persistent location of the DHCP snooping database.
ip dhcp snooping database write-delay	Configures the interval in seconds at which the DHCP Snooping database will be stored in persistent storage.
show ip dhcp snooping database	Displays the DHCP snooping configuration related to the database persistence.

DHCP Snooping Static Bindings Configuration

Use the [DHCP Snooping Static Bindings Configuration](#) page to add static DHCP bindings to the binding database.

The DHCP snooping application uses DHCP messages to build and maintain the binding's database. The binding's database only includes data for clients on untrusted ports. DHCP snooping creates a tentative binding from DHCP DISCOVER and REQUEST messages. Tentative bindings tie a client to a port (the port where the DHCP client message was received). Tentative bindings are completed when DHCP snooping learns the client's IP address from a DHCP ACK message on a trusted port. DHCP snooping removes bindings in response to DECLINE, RELEASE, and NACK messages. The DHCP snooping application ignores the ACK messages as a reply to the DHCP Inform messages received on trusted ports. You can also enter static bindings into the binding database.

The DHCP binding database is persisted on a configured external server or locally in flash, depending on the user configuration. A row-wise checksum is placed in the text file that is going to be stored in the remote configured server. On reloading, the switch reads the configured binding file to build the DHCP snooping database. When the switch starts and the calculated checksum value equals the stored checksum, the switch reads entries from the binding file and populates the binding database. A checksum failure or a connection problem to the external configured server will cause the switch to loose the bindings and will cause a host's data loss if DAI is enabled.

When a switch learns of new bindings or when it loses bindings, the switch immediately updates the entries in the database. The switch also updates the entries in the binding file. The frequency at which the file is updated is based on a configurable delay, and the updates are batched.

If the absolute lease time of the snooping database entry expires, then that entry will be removed. You should take care of the system time to be consistent across the reboots. Otherwise, the snooping entries will not expire properly. If a host sends a DHCP release while the switch is rebooting then, when the switch receives the DHCP discovery or request, the client's binding will go to the tentative binding as shown in the following figure.

Figure 7-120. States of Client Binding

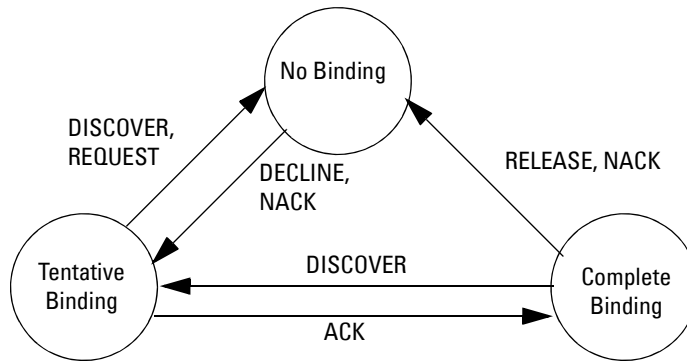

To access the DHCP Snooping Static Bindings Configuration page, click Switching → DHCP Snooping → Static Bindings Configuration in the navigation tree.

Figure 7-121. DHCP Snooping Static Bindings Configuration

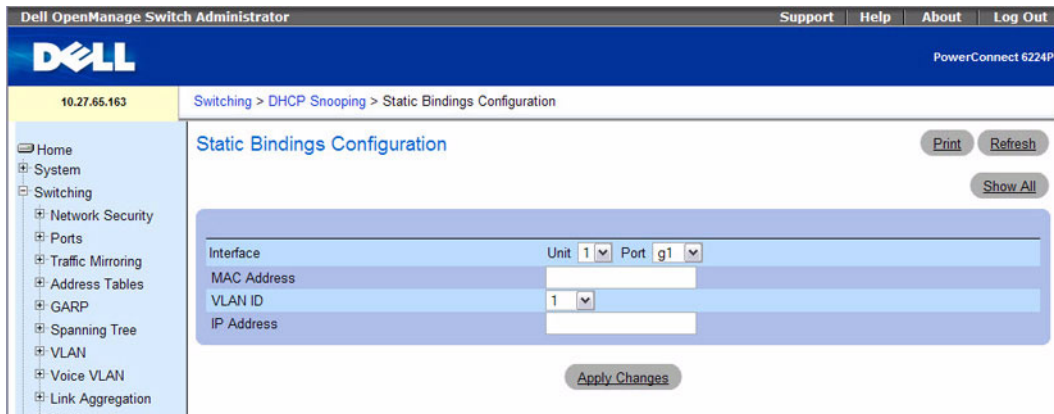

The DHCP Snooping Static Bindings Configuration page contains the following fields:

- **Interface** — Select the interface to add a binding into the DHCP snooping database.
- **MAC Address** — Specify the MAC address for the binding to be added. This is the Key to the binding database.
- **VLAN ID** — Select the VLAN from the list for the binding rule. The range of the VLAN ID is 1 to 4093.

- **IP Address** — Specify a valid IP address for the binding rule.

Displaying the DHCP Snooping Static Bindings Summary Table

1. Open the DHCP Snooping Static Bindings Configuration page.
2. Click Show All.

The DHCP Snooping Static Bindings Summary table displays.

Figure 7-122. DHCP Snooping Static Bindings Summary

Interface	MAC Address	VLAN ID	IP Address	Remove
1/g1	00:1C:23:55:D4:8E	1	192.168.3.45	<input type="checkbox"/>

Configuring DHCP Snooping Static Bindings With CLI Commands

For information about the CLI commands that perform this function, refer to the following chapter in the *CLI Reference Guide*:

- DHCP Snooping Commands

The following table summarizes the equivalent CLI commands for this feature.

Table 7-69. DHCP Snooping Static Bindings Configuration Commands

CLI Command	Description
ip dhcp snooping binding	Configures a static DHCP Snooping binding.

DHCP Snooping Dynamic Bindings Summary

The DHCP Snooping Dynamic Bindings Summary lists all the DHCP snooping dynamic binding entries learned on the switch ports.

To access the DHCP Snooping Dynamic Bindings Summary page, click **Switching** → **DHCP Snooping** → **Dynamic Bindings Summary** in the navigation tree.

Figure 7-123. DHCP Snooping Dynamic Bindings Summary

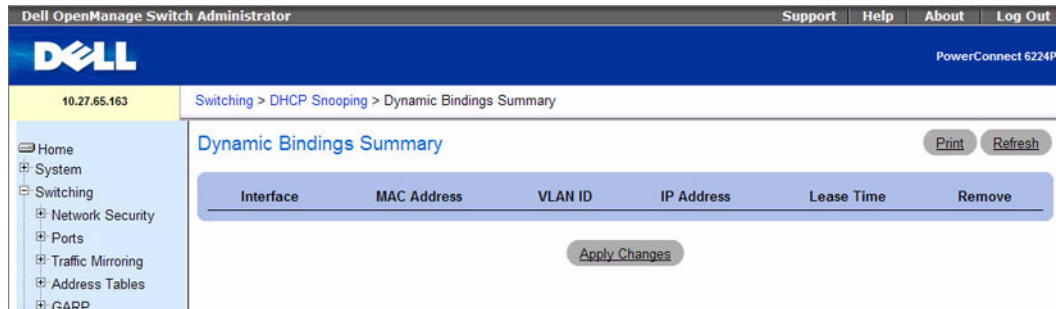

The DHCP Snooping Dynamic Bindings Summary page contains the following fields:

- **Interface** — Displays the interface.
- **MAC Address** — Displays the MAC address.
- **VLAN ID** — Displays the VLAN ID.
- **IP Address** — Displays the IP address.
- **Lease Time** — Displays the remaining Lease time for the dynamic entries.
- **Remove** — Select to remove the particular binding entry.

Viewing DHCP Snooping Dynamic Bindings Summary Information With CLI Commands

For information about the CLI commands that perform this function, refer to the following chapter in the *CLI Reference Guide*:

- DHCP Snooping Commands

The following table summarizes the equivalent CLI commands for this feature.

Table 7-70. DHCP Snooping Dynamic Bindings Summary Commands

CLI Command	Description
show ip dhcp snooping binding	Displays the DHCP snooping binding entries.
clear ip dhcp snooping binding	Clears all DHCP Snooping entries.

DHCP Snooping Statistics

The DHCP Snooping Statistics page displays DHCP snooping interface statistics.

To access the DHCP Snooping Statistics page, click **Switching** → **DHCP Snooping** → **Statistics** in the navigation tree.

Figure 7-124. DHCP Snooping Statistics

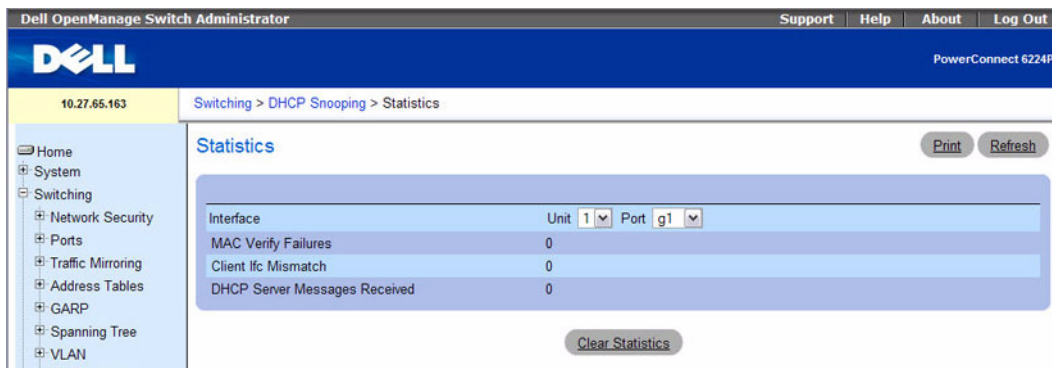

The **DHCP Snooping Statistics** page contains the following fields:

- **Interface** — Select the untrusted and snooping-enabled interface for which statistics are to be displayed.
- **MAC Verify Failures** — The number of DHCP messages that were filtered on an untrusted interface because of source MAC address and client MAC address mismatch.
- **Client Ifc Mismatch** — The number of DHCP release and Deny messages received on the different ports than previously learned.
- **DHCP Server Msgs Received** — The number of DHCP server messages received on untrusted ports.

Viewing DHCP Snooping Statistics With CLI Commands

For information about the CLI commands that perform this function, refer to the following chapter in the *CLI Reference Guide*:

- DHCP Snooping Commands

The following table summarizes the equivalent CLI commands for this feature.

Table 7-71. DHCP Snooping Statistics Commands

CLI Command	Description
show ip dhcp snooping statistics	Displays the DHCP snooping filtration statistics.
clear ip dhcp snooping statistics	clears all DHCP Snooping statistics.

DHCP Relay

When a DHCP client and server are in the same IP subnet, they can directly connect to exchange IP address requests and replies. However, having a DHCP server on each subnet can be expensive and is often impractical. Alternatively, network infrastructure devices can be used to relay packets between a DHCP client and server on different subnets. Such a device, a Layer 3 Relay agent, is generally a router that has IP interfaces on both the client and server subnets and can route between them. However, in Layer 2 switched networks, there may be one or more infrastructure devices (for example, a switch) between the client and the L3 Relay agent/DHCP server. In this instance, some of the client device information required by the L3 Relay agent may not be visible to it. In this case, an L2 Relay agent can be used to add the information that the L3 Relay Agent and DHCP server need to perform their roles in address and configuration and assignment.

Before it relays DHCP requests from clients, the switch can add a Circuit ID and a Remote ID. These provide information about the circuit and port number connected to the client. This information is added as suboptions in the DHCP Option 82 packets (see sections 3.1 and 3.2 of RFC3046). The switch removes this option from packets that it relays from L3 Relay agents/DHCP servers to clients.

These sub-options may be used by the DHCP server to affect how it treats the client, and also may be used by the relay agent to limit broadcast replies to the specific circuit or attachment point of the client.

The **Switching →DHCP Relay** page provides links to the following pages:

- DHCP Relay Global Configuration
- DHCP Relay Interface Configuration
- DHCP Relay Interface Statistics
- DHCP Relay VLAN Configuration

DHCP Relay Global Configuration

Use this page to enable or disable the switch to act as a DHCP Relay agent. This functionality must also be enabled on each port you want this service to operate on (see DHCP Relay Interface Configuration). The switch can also be configured to relay requests only when the VLAN of the requesting client corresponds to a service provider's VLAN ID that has been enabled with the L2 DHCP relay functionality (see DHCP Relay VLAN Configuration).

To access this page, click **Switching →DHCP Relay →Global Configuration** in the tree view.

Figure 7-125. DHCP Relay Global Configuration

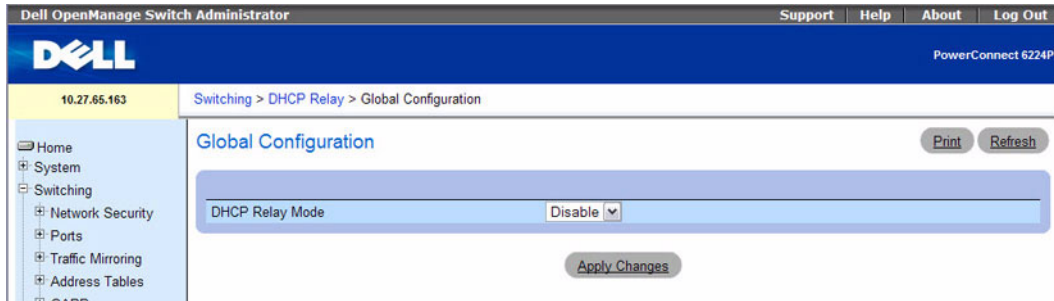

If you enable or disable the DHCP Relay feature, click **Apply Changes** to submit the changes to system.

Configuring DHCP Relay With CLI Commands

For information about the CLI commands that perform this function, refer to the following chapter in the *CLI Reference Guide*:

- L2 DHCP Relay Agent Commands

The following table summarizes the equivalent CLI commands for this feature.

Table 7-72. DHCP Relay Global Commands

CLI Command	Description
dhcp l2relay	Enables the Layer 2 DHCP Relay agent for an interface.

DHCP Relay Interface Configuration

Use this page to enable L2 DHCP relay on individual ports.

 **NOTE:** L2 DHCP relay must also be enabled globally on the switch.

To access this page, click **Switching** → **DHCP Relay** → **Interface Configuration** in the tree view.

Figure 7-126. DHCP Relay Interface Configuration

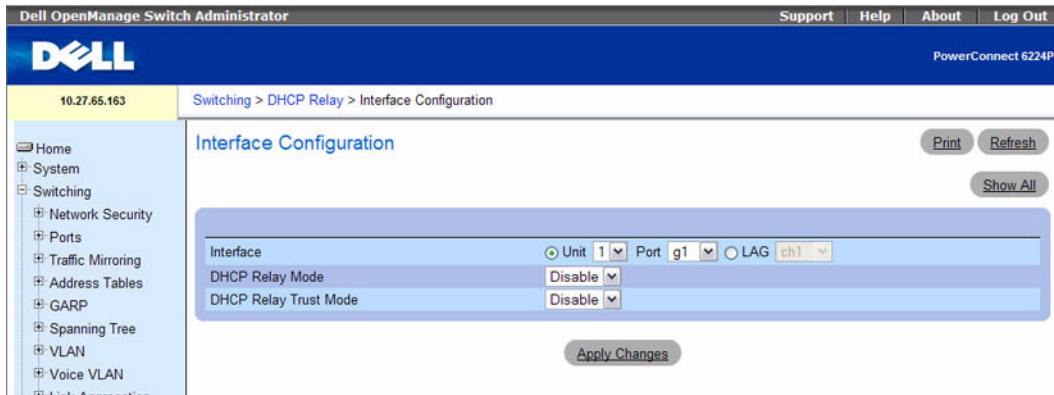

The **DHCP Relay Interface Configuration** page contains the following fields:

- **Interface** — Select the slot/port to configure this feature on.
- **DHCP Relay Mode** — Enable or disable L2 Relay mode on the selected interface.
- **DHCP Relay Trust Mode** — Enable or disable L2 Relay Trust Mode on the selected interface.

Trusted interfaces usually connect to other agents or servers participating in the DHCP interaction (e.g. other L2 or L3 Relay Agents or Servers). When enabled in Trust Mode, the interface always expects to receive DHCP packets that include Option 82 information. If Option 82 information is not included, then these packets are discarded.

Untrusted interfaces are generally connected to clients. DHCP packets arriving on an untrusted interface are never expected to carry Option 82 and are discarded if they do.

Displaying the DHCP Relay Interface Summary Table

1. Open the **DHCP Relay Interface Configuration** page.
2. Click **Show All**.

The **DHCP Relay Interface Summary** table displays.

Figure 7-127. DHCP Relay Interface Summary

Interface	DHCP Relay Mode	DHCP Relay Trust Mode
1/g1	Disable	Disable
1/g2	Disable	Disable
1/g3	Disable	Disable
1/g4	Disable	Disable
1/g5	Disable	Disable
1/g6	Disable	Disable
1/g7	Disable	Disable
1/g8	Disable	Disable
1/g9	Disable	Disable
1/g10	Disable	Disable

Configuring DHCP Relay With CLI Commands

For information about the CLI commands that perform this function, refer to the following chapter in the *CLI Reference Guide*:

- L2 DHCP Relay Agent Commands

The following table summarizes the equivalent CLI commands for this feature.

Table 7-73. DHCP Relay Interface Configuration Commands

CLI Command	Description
dhcp l2relay	Enables the Layer 2 DHCP Relay agent for an interface.
dhcp l2relay trust	Configures an interface to trust a received DHCP Option 82.

DHCP Relay Interface Statistics

Use this page to display statistics on DHCP Relay requests received on a selected port. To access this page, click Switching → DHCP Relay → Interface Statistics in the tree view.

Figure 7-128. DHCP Relay Interface Statistics

10.27.65.163 | Switching > DHCP Relay > Interface Statistics

Interface Statistics

Unit: 1 | Port: g1

Untrusted Server Messages With Option-82	0
Untrusted Client Messages With Option-82	0
Trusted Server Messages Without Option-82	0
Trusted Client Messages Without Option-82	0

The **DHCP Relay Interface Statistics** page contains the following fields:

- **Interface** — Select the slot/port to configure this feature on.
- **Untrusted Server Msgs With Option-82** — If the selected interface is configured in untrusted mode, this field shows the number of messages received on the interface from a DHCP server that contained Option 82 data. These messages are dropped.
- **Untrusted Client Msgs With Option-82** — If the selected interface is configured in untrusted mode, this field shows the number of messages received on the interface from a DHCP client that contained Option 82 data. These messages are dropped.
- **Trusted Server Msgs Without Option-82** — If the selected interface is configured in trusted mode, this field shows the number of messages received on the interface from a DHCP server that did not contain Option 82 data. These messages are dropped.
- **Trusted Client Msgs Without Option-82** — If the selected interface is configured in trusted mode, this field shows the number of messages received on the interface from a DHCP client that did not contain Option 82 data. These messages are dropped.

Use the buttons on the page to perform the following:

- Click **Clear** to set statistics for this port to their initial values.
- Click **Clear All** to set statistics for all ports to their initial values.

Viewing DHCP Relay Statistics With CLI Commands

For information about the CLI commands that perform this function, refer to the following chapter in the *CLI Reference Guide*:

- L2 DHCP Relay Agent Commands

The following table summarizes the equivalent CLI commands for this feature.

Table 7-74. DHCP Relay Statistics Configuration Command

CLI Command	Description
show dhcp l2relay stats	Displays statistics for L2 DHCP relay.
clear dhcp l2relay statistics	Clears all dhcp L2 relay statistics.

DHCP Relay VLAN Configuration

You can enable L2 DHCP relay on a particular VLAN. The VLAN is identified by a service VLAN ID (S-VID), which a service provider uses to identify a customer's traffic while traversing the provider network to multiple remote sites. The switch uses the VLAN membership of the switch port client (the customer VLAN ID, or C-VID) to perform a lookup a corresponding S-VID.

If the S-VID is enabled for DHCP Relay, then the packet can be forwarded. If the C-VID does not correspond to an S-VID that is enabled for DHCP Relay, then the switch will not relay the DHCP request packet.

To access this page, click **Switching** → **DHCP Relay** → **VLAN Configuration** in the tree view.

Figure 7-129. DHCP Relay VLAN Configuration

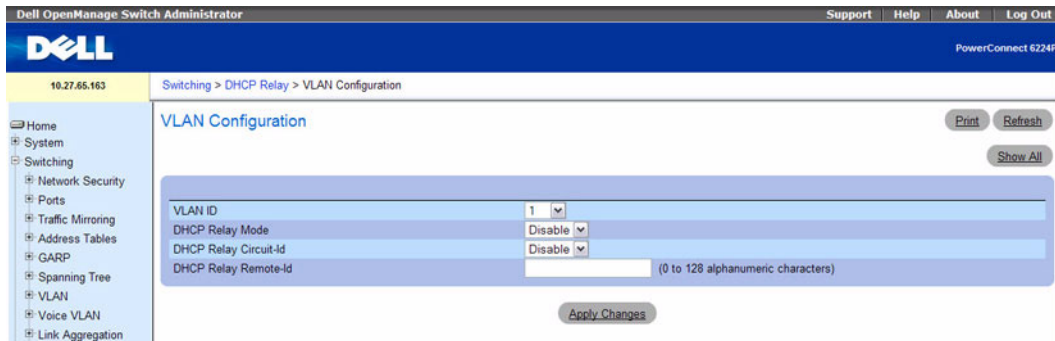

The **DHCP Relay VLAN Configuration** page contains the following fields:

- **VLAN ID** — Select a VLAN ID from the list for configuration. This is an S-VID (as indicated by the service provider) that identifies a VLAN that is authorized to relay DHCP packets through the provider network.
- **DHCP Relay Mode** — Enable or disable the selected VLAN for DHCP Relay services. The default is **Disable**.
- **DHCP Relay Circuit-Id** — When enabled, if a client sends a DHCP request to the switch and the client is in a VLAN that corresponds to the selected S-VID, the switch adds the client’s interface number to the Circuit ID sub-option of Option 82 in the DHCP request packet. The default is **Disable**.

This enables the switch to reduce the broadcast domain to which the server replies are switched when the broadcast bit is set for DHCP packets. When this bit is set, the server is required to echo the Option-82 in replies. Since the circuit-id field contains the client interface number, the L2 relay agent can forward the response to the requesting interface only, rather to all ports in the VLAN).

- **DHCP Relay Remote-Id** — When a string is entered here, if a client sends a DHCP request to the switch and the client is in a VLAN that corresponds to the selected S-VID, then the switch adds the string to the Remote-ID sub-option of Option 82 in the DHCP request packet. The range is 0-128 alphanumeric characters. The default is **NULL** string.

This sub-option can be used by the server for parameter assignment. The content of this option is vendor-specific.

Displaying the DHCP Relay VLAN Summary Table

1. Open the DHCP Relay VLAN Configuration page.
2. Click Show All.

The DHCP Relay VLAN Summary table displays.

Figure 7-130. DHCP Relay VLAN Summary

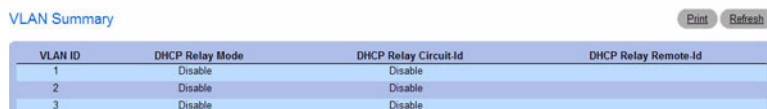

The screenshot shows a web interface titled "VLAN Summary" with "Print" and "Refresh" buttons. Below the title is a table with four columns: "VLAN ID", "DHCP Relay Mode", "DHCP Relay Circuit-Id", and "DHCP Relay Remote-Id". The table contains three rows of data, all with "Disable" in the "DHCP Relay Mode" column.

VLAN ID	DHCP Relay Mode	DHCP Relay Circuit-Id	DHCP Relay Remote-Id
1	Disable	Disable	
2	Disable	Disable	
3	Disable	Disable	

Configuring DHCP Relay With CLI Commands

For information about the CLI commands that perform this function, refer to the following chapter in the *CLI Reference Guide*:

- L2 DHCP Relay Agent Commands

The following table summarizes the equivalent CLI commands for this feature.

Table 7-75. DHCP Relay VLAN Configuration Commands

CLI Command	Description
dhcp l2relay circuit-id	Enables user to set the DHCP Option 82 Circuit ID for a VLAN.
dhcp l2relay remote-id	Enables user to set the DHCP Option 82 Remote ID for a VLAN.
dhcp l2relay vlan	Enables the L2 DHCP Relay agent for a set of VLANs.

Viewing Statistics and Remote Monitoring

Overview

This section explains the RMON options available from the **Statistics/RMON** menu page. These options include viewing statistics in table form, editing and viewing RMON statistics, and charting Port and LAG statistics. The **Statistics/RMON** menu page provides access to these options through the following menu pages:

- Table Views
- RMON
- Charts

 **NOTE:** CLI commands are not available for all the **Statistics/RMON** pages.

Remote Monitoring (RMON) allows the network administrator to get an idea of the network's performance and status through remote access. Four monitoring groups (defined as part of the RMON standard) are supported:

- Statistics
- History
- Alarms
- Events

Table Views

The **Table Views** menu page contains links to web pages that display statistics in table form. To display this page, click **Statistics/RMON** → **Table Views** in the tree view. Following are the web pages accessible from this menu page:

- Interface Statistics
- Etherlike Statistics
- GVRP Statistics
- EAP Statistics
- Utilization Summary
- Counter Summary

Interface Statistics

Use the **Interface Statistics** page to display statistics for both received and transmitted packets. The fields for both received and transmitted packets are identical.

To display the page, click **Statistics/RMON** → **Table Views** → **Interface Statistics** in the tree view.

Figure 8-1. Interface Statistics

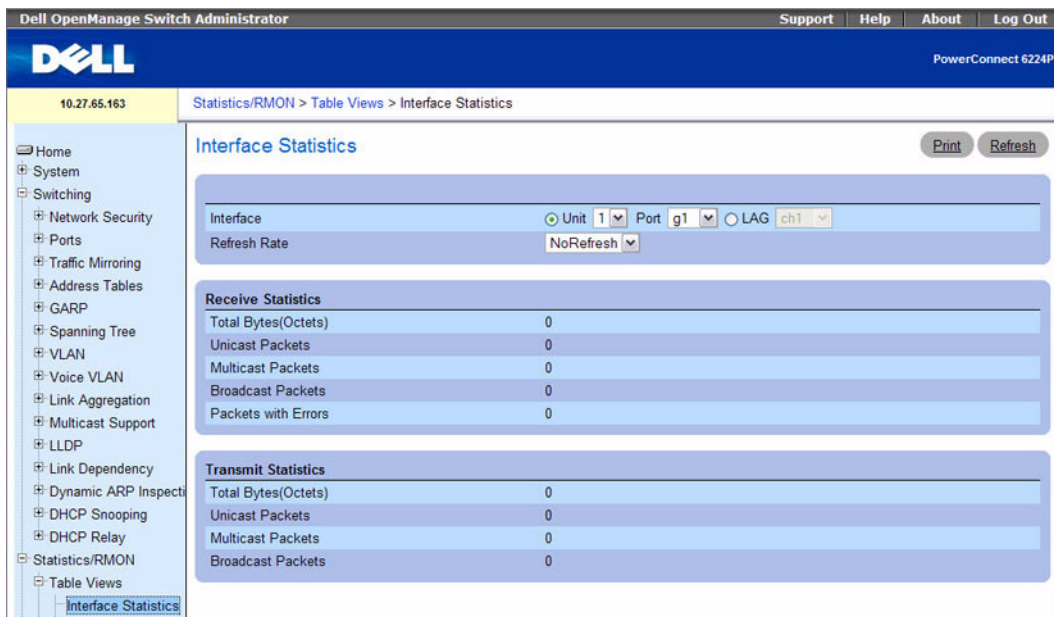

The **Interface Statistics** page contains the following fields:

- **Interface** — Select physical interface (unit, port) or LAG interface for which statistics is displayed.
- **Refresh Rate** — Specifies amount of time that passes before statistics are refreshed. The possible field values are No Refresh, 15, 30 and 60 seconds. Default is No Refresh.

Received Statistics

- **Total Bytes (Octets)** — Displays the total number of octets received on the selected interface.
- **Unicast Packets** — Displays the total number of Unicast packets received on the selected interface.
- **Multicast Packets** — Displays the total number of Multicast packets received on the selected interface.
- **Broadcast Packets** — Displays the total number of Broadcast packets received on the selected interface.
- **Packets with Errors** — Displays the total number of packets with errors received on the selected interface.

Transmit Statistics

- **Total Bytes (Octets)** — Displays the total number of octets transmitted on the selected interface.
- **Unicast Packets** — Displays the total number of Unicast packets transmitted on the selected interface.
- **Multicast Packets** — Displays the total number of Multicast packets transmitted on the selected interface.
- **Broadcast Packets** — Displays the total number of Broadcast packets transmitted on the selected interface.

Displaying Interface Statistics

1. Open the **Interface Statistics** page.
2. Specify an interface.
Statistics for specified interface display.

Viewing Interface Statistics Using CLI Commands

For information about the CLI commands that perform this function, see the following chapter in the *CLI Reference Guide*:

- Ethernet Configuration Commands

The following table summarizes the equivalent CLI commands for this feature.

Table 8-1. Interface Statistics Commands

CLI Command	Description
show interfaces counters	Display traffic seen by the interface.

Etherlike Statistics

Use the Etherlike Statistics page to display interface statistics.

To display the page, click **Statistics/RMON** → **Table Views** → **Etherlike Statistics** in the tree view.

Figure 8-2. Etherlike Statistics

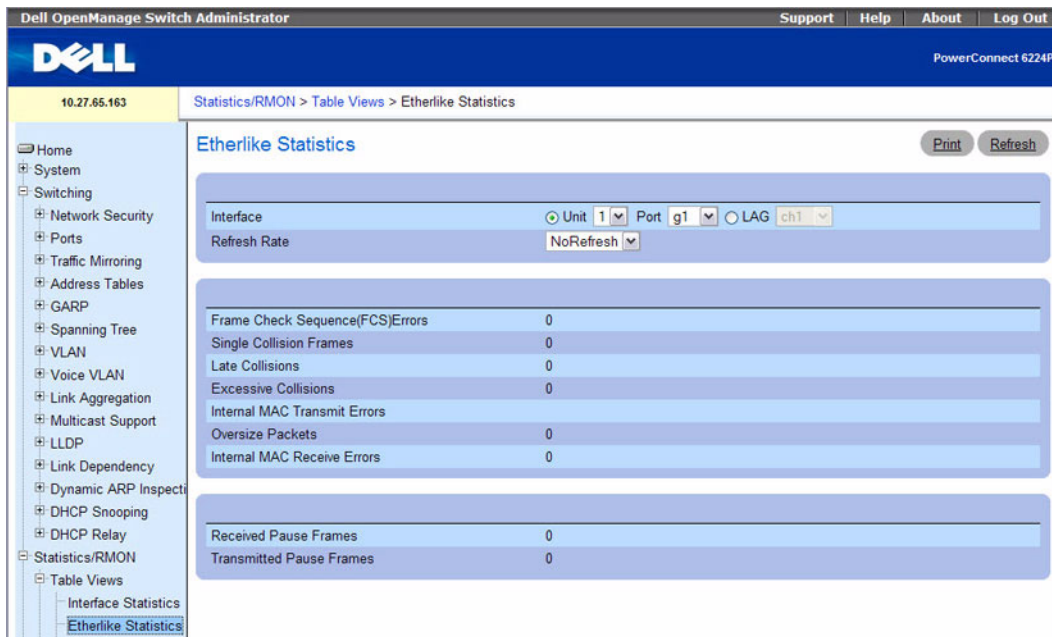

The Etherlike Statistics page contains the following fields:

- **Interface** — Select physical interface (unit, port) or LAG interface for which statistics is displayed.
- **Refresh Rate** — Specifies amount of time that passes before statistics are refreshed. The possible field values are No Refresh, 15, 30 and 60 seconds. Default is No Refresh.
- **Frame Check Sequence (FCS) Errors** — Displays number of FCS errors received on the selected interface.
- **Signal Collision Frames** — Displays number of signal collision frame errors received on the selected interface.
- **Late Collisions** — Displays number of late collisions received on the selected interface.
- **Excessive Collisions** — Displays number of excessive collisions received on the selected interface.
- **Internal MAC Transmit Errors** — Displays number of internal MAC transmit errors on the selected interface.

- **Oversize Packets** — Displays the total number of packets received that were longer than 1518 octets (excluding framing bits, but including FCS octets) and were otherwise well formed.
- **Internal MAC Receive Errors** — Displays number of internal MAC received errors on the selected interface.
- **Received Pause Frames** — Displays number of received paused frames on the selected interface.
- **Transmitted Pause Frames** — Displays number of transmitted paused frames on the selected interface.

Displaying Etherlike Statistics for an Interface

1. Open the **Etherlike Statistics** page.
2. Specify an interface.
Statistics for the specified interface display.

Viewing Interface Statistics Using CLI Commands

For information about the CLI commands that perform this function, see the following chapter in the *CLI Reference Guide*:

- Ethernet Configuration Commands

The following table summarizes the equivalent CLI commands for this feature.

Table 8-2. Interface Commands

CLI Command	Description
show statistics ethernet	Displays detailed statistics for a specific port or for the entire switch.

GVRP Statistics

Use the **GVRP Statistics** page to display switch statistics for GVRP.

To display the page, click **Statistics/RMON** → **Table Views** → **GVRP Statistics** in the tree view.

Figure 8-3. GVRP Statistics

The screenshot shows the Dell OpenManage Switch Administrator interface. The top navigation bar includes 'Support', 'Help', 'About', and 'Log Out'. The breadcrumb trail indicates the path: 'Statistics/RMON > Table Views > GVRP Statistics'. The left-hand navigation menu is expanded to 'Table Views' > 'GVRP Statistics'. The main content area displays the 'GVRP Statistics' page for interface 'Unit 1 Port g1 LAG ch1'. It features a 'Refresh Rate' dropdown set to 'NoRefresh' and two data tables.

Attribute(Counter) Statistics

Attribute(Counter)	Received	Transmitted
Join Empty	0	0
Empty	0	0
Leave Empty	0	0
Join In	0	0
Leave In	0	0
Leave All	0	0

Error Statistics

Error Statistics	Received
Invalid Protocol ID	0
Invalid Attribute Type	0
Invalid Attribute Value	0
Invalid Attribute Length	0
Invalid Event	0

The **GVRP Statistics** page contains the following fields:

- **Interface** — Select physical interface (unit, port) or LAG interface for which statistics will be displayed.
- **Refresh Rate** — Specifies amount of time that passes before statistics are refreshed. The possible field values are No Refresh, 15, 30, and 60 seconds. Default is No Refresh.

GVRP Statistics Table Attribute (Counters) - Received and Transmitted

- **Join Empty** — Displays switch GVRP Join Empty statistics.
- **Empty** — Displays switch GVRP Empty statistics.
- **Leave Empty** — Displays switch GVRP Leave Empty statistics.
- **Join In** — Displays switch GVRP Join In statistics.
- **Leave In** — Displays switch GVRP Leave In statistics.
- **Leave All** — Displays switch GVRP Leave All statistics.

Error Statistics - Received

- **Invalid Protocol ID** — Displays switch GVRP Invalid Protocol ID statistics.
- **Invalid Attribute Type** — Displays switch GVRP Invalid Attribute Type statistics.
- **Invalid Attribute Value** — Displays switch GVRP Invalid Attribute Value statistics.
- **Invalid Attribute Length** — Displays switch GVRP Invalid Attribute Length statistics.
- **Invalid Event** — Displays switch GVRP Invalid Event statistics.

Displaying GVRP Statistics for an Interface

1. Open the **GVRP Statistics** page.
2. Select an interface in the **Interface** field.
GVRP Statistics display for the specified interface.

Viewing GVRP Statistics Using CLI Commands

For information about the CLI commands that perform this function, see the following chapter in the *CLI Reference Guide*:

- **GVRP Commands**

The following table summarizes the equivalent CLI commands for this feature.

Table 8-3. GVRP Statistics Commands

CLI Command	Description
show gvrp statistics	Displays GVRP statistics.

EAP Statistics

Use the EAP Statistics page to display information about EAP packets received on a specific port. For more information about EAP, see "Dot1x Authentication."

To display the EAP Statistics page, click **Statistics/RMON** → **Table Views** → **EAP Statistics** in the tree view.

Figure 8-4. EAP Statistics

The screenshot shows the Dell OpenManage Switch Administrator interface. The top navigation bar includes 'Support', 'Help', 'About', and 'Log Out'. The main header displays the Dell logo and 'PowerConnect 6224P'. The breadcrumb trail is 'Statistics/RMON > Table Views > EAP Statistics'. The left navigation tree shows 'Statistics/RMON' expanded to 'Table Views', with 'Interface Statistics' selected. The main content area is titled 'EAP Statistics' and includes 'Print' and 'Refresh' buttons. Below the title, there are configuration options: 'Interface' (Unit: 1, Port: g1) and 'Refresh Rate' (NoRefresh). A table displays the following statistics:

Frames Received	0
Frames Transmitted	0
Start Frames Received	0
Log off Frames Received	0
Response ID Frames Received	0
Response Frames Received	0
Request Frames Transmitted	0
Request ID Frames Transmitted	0
Invalid Frames Received	0
Length Error Frames Received	0
Last Frames Version	0
Last Frames Source	00:00:00:00:00:00

The EAP Statistics page contains the following fields:

- **Interface** — Specifies the interface which is polled for statistics.
- **Refresh Rate** — Specifies amount of time that passes before statistics are refreshed. The possible field values are No Refresh, 15, 30, and 60 seconds. Default is No Refresh.
- **Frames Received** — Displays the number of valid EAPOL frames received on the port.
- **Frames Transmitted** — Displays the number of EAPOL frames transmitted through the port.
- **Start Frames Received** — Displays the number of EAPOL Start frames received on the port.
- **Log off Frames Received** — Displays the number of EAPOL Log off frames that have been received on the port.
- **Respond ID Frames Received** — Displays the number of EAP Respond ID frames that have been received on the port.

- **Respond Frames Received** — Displays the number of valid EAP Respond frames received on the port.
- **Request ID Frames Received** — Displays the number of EAP Request ID frames that have been received on the port.
- **Request Frames Transmitted** — Displays the number of EAP Request frames transmitted through the port.
- **Request ID Frames Transmitted** — Displays the number of EAP Requested ID frames transmitted through the port.
- **Invalid Frames Received** — Displays the number of unrecognized EAPOL frames received on this port.
- **Length Error Frames Received** — Displays the number of EAPOL frames with an invalid Packet Body Length received on this port.
- **Last Frames Version** — Displays the protocol version number attached to the most recently received EAPOL frame.
- **Last Frames Source** — Displays the source MAC Address attached to the most recently received EAPOL frame.

Displaying EAP statistics for an Interface

1. Open the **EAP Statistics** page.
2. Select an interface in the **Interface** field.

The EAP statistics for the selected interface display.

Viewing EAP Statistics Using CLI Commands

For information about the CLI commands that perform this function, see the following chapter in the *CLI Reference Guide*:

- 802.1X Commands

The following table summarizes the equivalent CLI commands for this feature.

Table 8-4. EAP Statistics Commands

CLI Command	Description
show dot1x statistics	Displays 802.1x statistics for the specified interface.

Utilization Summary

Use the **Utilization Summary** page to display interface utilization statistics.

To display the page, click **Statistics/RMON** → **Table Views** → **Utilization Summary** in the tree view.

Figure 8-5. Utilization Summary

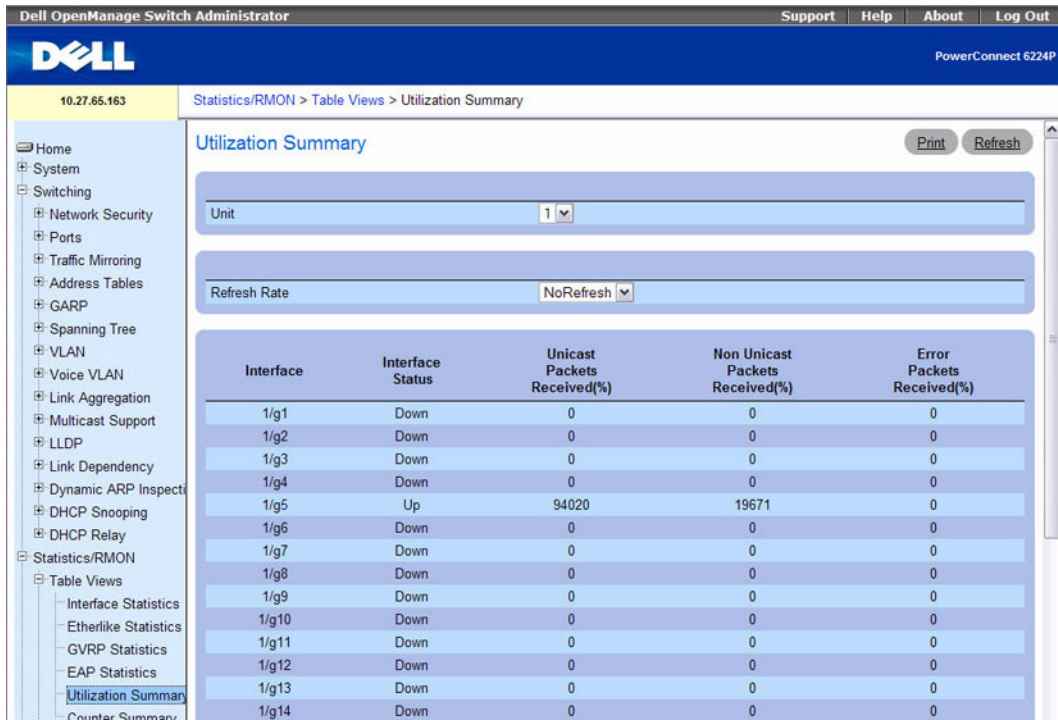

The Utilization Summary page contains the following fields:

- **Unit** — Specifies the unit for which statistics are displayed.
- **Refresh Rate** — Specifies amount of time that passes before statistics are refreshed. The possible field values are No Refresh, 15, 30, and 60 seconds. Default is No Refresh.
- **Interface** — Specifies the interface for which statistics are displayed.
- **Interface Status** — Displays status of the interface.
- **Interface Utilization %** — Displays network interface utilization percentage based on the duplex mode of the interface. The range of this reading is from 0 to 200%. The maximum reading of 200% for a full-duplex connection indicates that 100% of bandwidth of incoming and outgoing connections is used by the traffic travelling through the interface. The maximum reading for a half-duplex connection is 100%.
- **Unicast Received %** — Displays percentage of Unicast packets received on the interface.
- **Non Unicast Packets Received %** — Displays percentage of non-Unicast packets received on the interface.

- **Error Packets Received %** — Displays number packets with errors received on the interface.

Viewing Interface Utilization Statistics Using CLI Commands

For information about the CLI commands that perform this function, see the following chapter in the *CLI Reference Guide*:

- RMON Commands

The following table summarizes the equivalent CLI commands for this feature.

Table 8-5. Utilization Summary Commands

CLI Command	Description
show rmon statistics	Displays RMON Ethernet Statistics.

Counter Summary

Use the **Counter Summary** page to display interface utilization statistics in numeric sums as opposed to percentages.

To display the page, click **Statistics/RMON** → **Table Views** → **Counter Summary** in the tree view.

Figure 8-6. Counter Summary

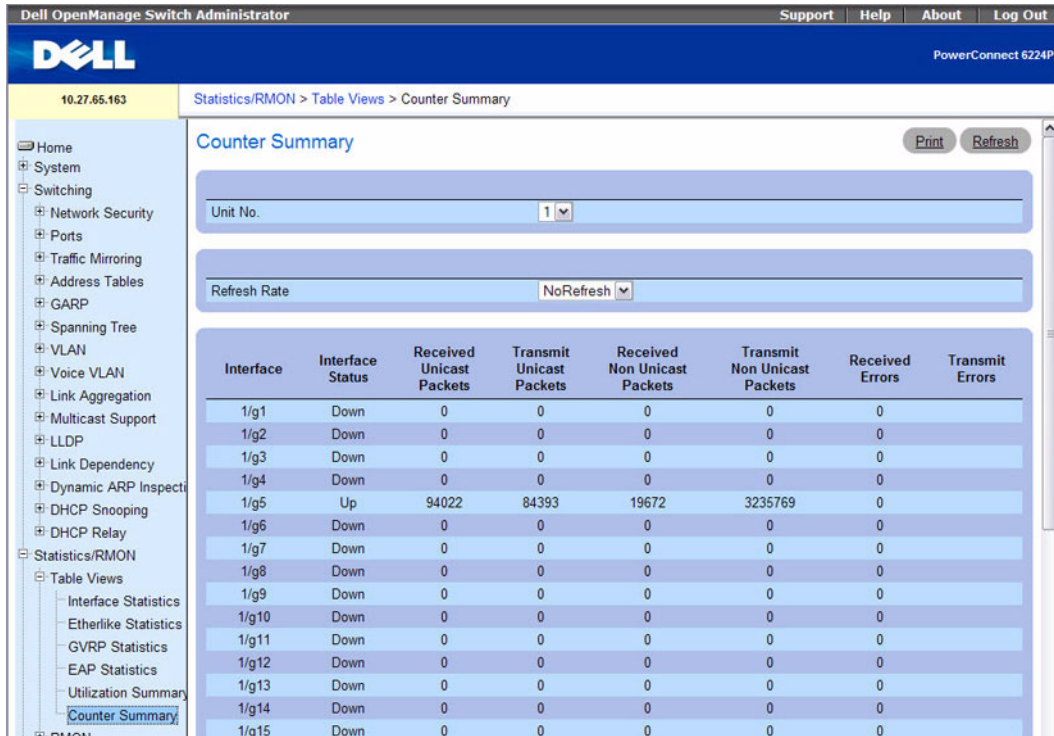

The Counter Summary page contains the following fields:

- **Unit** — Specifies the unit for which statistics are displayed.
- **Refresh Rate** — Specifies amount of time that passes before statistics are refreshed. The possible field values are No Refresh, 15, 30, and 60 seconds. Default is No Refresh.
- **Interface** — Specifies the interface for which statistics are displayed.
- **Interface Status** — Displays status of the interface.
- **Received Unicast Packets** — Displays number of received Unicast packets on the interface.
- **Transmit Unicast Packets** — Displays number of transmitted Unicast packets from the interface.
- **Received Non Unicast Packets** — Displays number of received non-Unicast packets on the interface.
- **Transmit Non Unicast Packets** — Displays number of transmitted non-Unicast packets from the interface.
- **Received Errors** — Displays number of received errors on the interface.
- **Transmit Errors** — Displays number of transmitted errors from the interface.

Setting Refresh Rate

1. Open the Counter Summary page.
2. Select the Refresh Rate from the drop-down menu.
Statistics refresh for the displayed interfaces at the selected frequency.

Viewing Numeric Port Utilization Statistics Using CLI Commands

For information about the CLI commands that perform this function, see the following chapter in the *CLI Reference Guide*:

- RMON Commands

The following table summarizes the equivalent CLI commands for this feature.

Table 8-6. Numeric Port Utilization Statistics Commands

CLI Command	Description
show rmon statistics	Displays RMON Ethernet Statistics.

RMON

Remote monitoring (RMON) allows the network administrator to get an idea of the network's performance and status through remote access.

To display the RMON menu page, click **Statistics/RMON →RMON** in the tree view. The RMON menu page contains links to the following features:

- RMON Statistics
- RMON History Control Statistics
- RMON History Table
- RMON Event Control
- RMON Event Log
- RMON Alarms

RMON Statistics

Use the RMON Statistics page to display details about switch use such as packet processing statistics and errors that have occurred on the switch.

To display the page, click **Statistics/RMON →RMON →Statistics** in the tree view.

Figure 8-7. RMON Statistics

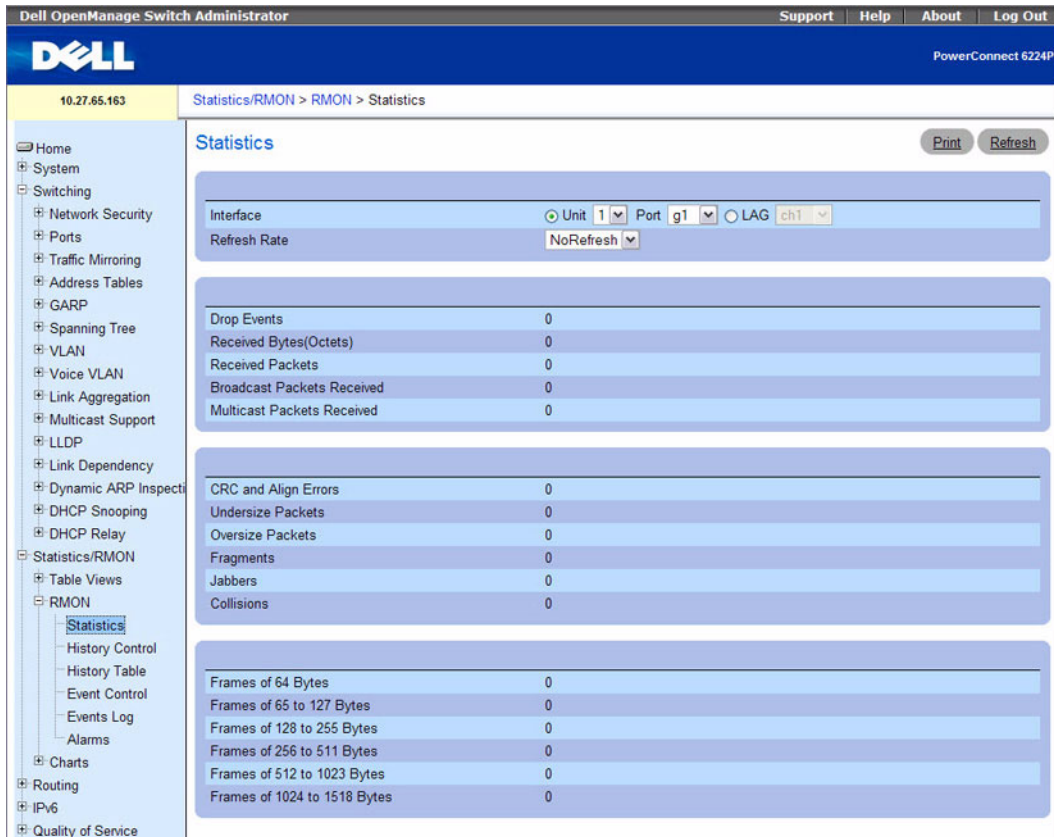

The RMON Statistics page contains the following fields:

- **Interface** — Specifies whether statistics are shown for a Unit or a LAG as well as which Unit/LAG is displayed.
- **Refresh Rate** — Specifies amount of time that passes before statistics are refreshed. The possible field values are No Refresh, 15, 30, and 60 seconds. Default is No Refresh.
- **Drop Events** — Displays number of dropped events that have occurred on the interface since the switch was last refreshed.
- **Received Bytes (Octets)** — Displays number of octets received on the interface since the switch was last refreshed. This number includes bad packets and FCS octets, but excludes framing bits.
- **Received Packets** — Displays number of packets received on the interface, including bad packets, multicast and broadcast packets, since the switch was last refreshed.

- **Broadcast Packets Received** — Displays number of good broadcast packets received on the interface since the switch was last refreshed. This number does not include multicast packets.
- **Multicast Packets Received** — Displays number of good multicast packets received on the interface since the switch was last refreshed.
- **CRC & Align Errors** — Displays number of CRC and Align errors that have occurred on the interface since the switch was last refreshed.
- **Undersize Packets** — Displays number of undersized packets (less than 64 octets) received on the interface since the switch was last refreshed.
- **Oversize Packets** — Displays number of oversized packets (over 1518 octets) received on the interface since the switch was last refreshed.
- **Fragments** — Displays number of fragments (packets with less than 64 octets, excluding framing bits, but including FCS octets) received on the interface since the switch was last refreshed.
- **Jabbers** — Displays number of packets received that were more than 1,518 octets long and had a FCS during the sampling session.
- **Collisions** — Displays number of collisions received on the interface since the switch was last refreshed.
- **Frames of 64 Bytes** — Displays number of 64-byte frames received on the interface since the switch was last refreshed.
- **Frames of 65 to 127 Bytes** — Displays number of 65- to 127-byte frames received on the interface since the switch was last refreshed.
- **Frames of 128 to 255 Bytes** — Displays number of 128- to 255-byte frames received on the interface since the switch was last refreshed.
- **Frames of 256 to 511 Bytes** — Displays number of 256- to 511-byte frames received on the interface since the switch was last refreshed.
- **Frames of 512 to 1023 Bytes** — Displays number of 512- to 1023-byte frames received on the interface since the switch was last refreshed.
- **Frames of 1024 to 1518 Bytes** — Displays number of 1024- to 1518-byte frames received on the interface since the switch was last refreshed.

Viewing Interface Statistics

1. Open the **RMON Statistics Group** page.
2. Select an interface in the **Interface** field.
Statistics for the selected interface display.

Viewing RMON Statistics Using CLI Commands

For information about the CLI commands that perform this function, see the following chapter in the *CLI Reference Guide*:

- RMON Commands

The following table summarizes the equivalent CLI commands for this feature.

Table 8-7. RMON Commands

CLI Command	Description
show rmon statistics	Displays RMON Ethernet Statistics.

RMON History Control Statistics

Use the **RMON History Control** page to maintain a history of statistics on each port. For each interface (either a physical port or a port-channel), you can define how many buckets exist, and the time interval between each bucket snapshot.

To display the page, click **Statistics/RMON → RMON → History Control** in the tree view.

Figure 8-8. RMON History Control

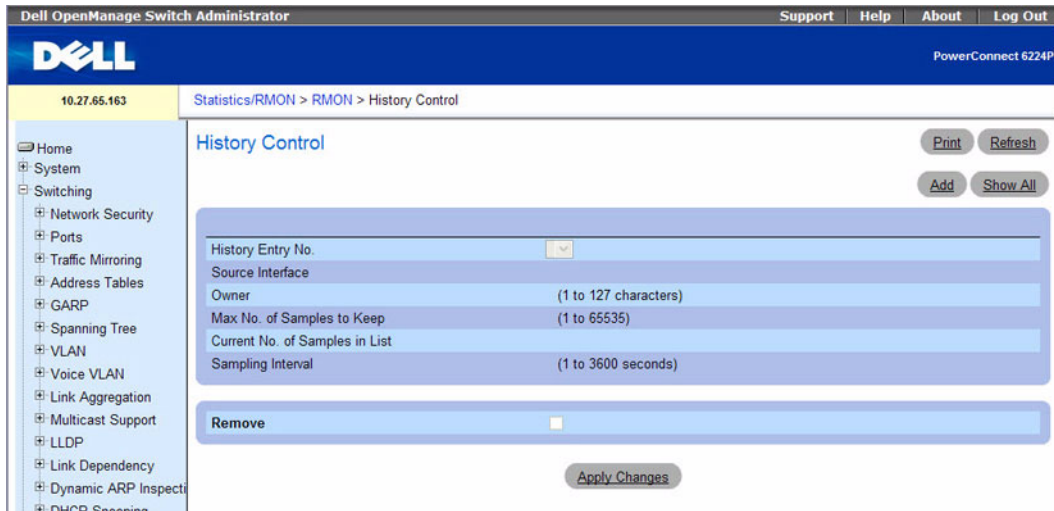

The RMON History Control page contains the following fields:

- **History Entry** — Selects entry number on the RMON History Control Table.
- **Source Interface** — Specifies interface from which the history samples are taken.
- **Owner (0–20 characters)** — Indicates RMON station or user that requested the RMON information.
- **Max No. of Samples to Keep (1–65535)** — Sets the number of historical buckets for this interface.
- **Current No. of Samples in List** — Displays the current number of samples taken.

- **Sampling Interval (1–3600)** — Sets the frequency at which samplings are taken from the ports. The possible values are from 1 to 3600 seconds. The default is 1800 seconds (30 minutes).
- **Remove** — Removes the **RMON History Control Table** entry displayed when checked.

Adding a History Control Entry

1. Open the **RMON History Control** page.
2. Click **Add**.

The **Add History Entry** page displays.

Figure 8-9. Add History Entry

The screenshot shows the 'Add History Entry' configuration page. At the top, there is a title 'Add History Entry' and two buttons: 'Print' and 'Refresh'. Below the title is a form with the following fields:

- New History Entry**: A text input field containing the value '3'.
- Source Interface**: A section with two radio buttons. The first is 'Unit No. 1' (selected) and the second is 'LAG ch1'.
- Owner (0 to 20 characters)**: A text input field.
- Max No. of Samples to Keep (1-65535)**: A text input field.
- Sampling Interval (1 to 3600) (Sec)**: A text input field.

At the bottom of the form, there are two buttons: 'Apply Changes' and 'Back'.

3. Complete the fields on this page and click **Apply Changes**.
The entry is added to the **RMON History Control Table**.

Displaying the RMON History Control Table

1. Open the **RMON History Control** page.
2. Click **Show All**.

The **RMON History Control Table** displays.

Figure 8-10. RMON History Control Table

The screenshot shows the Dell OpenManage Switch Administrator interface. The top navigation bar includes 'Support', 'Help', 'About', and 'Log Out'. The main content area is titled 'History Control' and contains several configuration fields: 'History Entry No.' (a dropdown menu), 'Source Interface', 'Owner' (with a character limit of 1 to 127), 'Max No. of Samples to Keep' (1 to 65535), 'Current No. of Samples in List', and 'Sampling Interval' (1 to 3600 seconds). There is a 'Remove' checkbox at the bottom of the configuration area. Below this is a 'History Control Table' with a 'Print' and 'Refresh' button. The table has the following data:

History Entry No.	Source Interface	Sampling Interval	Current Number of Samples	Owner	Remove
1	1/xg1	1800	10		<input type="checkbox"/>

At the bottom of the table are 'Apply Changes' and 'Back' buttons.

Removing a History Control Table Entry

1. Open the RMON History Control page.
2. Select the Remove check box in the row of the history entry to remove.
3. Click Apply Changes.

The table entry is removed, and the device is updated.

Viewing RMON History Control Using CLI Commands

For information about the CLI commands that perform this function, see the following chapter in the *CLI Reference Guide*:

- RMON Commands

The following table summarizes the equivalent CLI commands for this feature.

Table 8-8. RMON History Control Commands

CLI Command	Description
rmon collection history	Enables a Remote Monitoring (RMON) MIB history statistics group on an interface.

RMON History Table

Use the RMON History Table page to display interface-specific statistical network samplings. Each table entry represents all counter values compiled during a single sample.

To display the RMON History Table page, click **Statistics/RMON → RMON → History Table** in the tree view.

Figure 8-11. RMON History Table

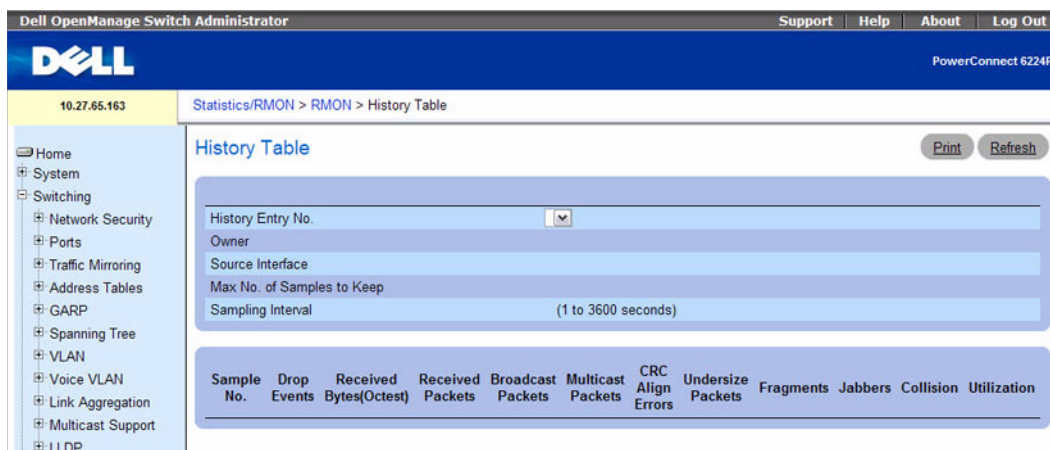

The RMON History Table page contains the following fields:

- **History Entry No.** — Selects the history entry number to display on the RMON History Table.
- **Owner** — Displays RMON statistics group owner name, if available.
- **Source Interface** — Indicates the Interface or LAG where the statistics are being collected.
- **Max No. of Samples to Keep** — Determines the length of the list in the History table for each History Entry No.
- **Sampling Interval** — Sets the time in seconds between successive samples.
- **Sample No.** — Indicates the specific sample the information in the table reflects.

- **Drop Events** — Displays the total number of events in which packets were dropped by the port due to lack of resources. Note that this number is not necessarily the number of packets dropped; it is just the number of times this condition has been detected.
- **Received Bytes (Octets)**— Displays the total number of octets of data (including those in bad packets) received on the network (excluding framing bits but including Frame Check Sequence (FCS) octets).
- **Received Packets** — Displays the total number of packets received (including bad packets, broadcast packets, and multicast packets) during the sampling interval.
- **Broadcast Packets** — Displays the total number of good packets received that were directed to the broadcast address. Note that this does not include multicast packets.
- **Multicast Packets** — Displays the total number of good packets received that were directed to a multicast address. Note that this number does not include packets directed to the broadcast address.
- **CRC Align Errors** — Displays the total number of packets received that had a length (excluding framing bits, but including FCS octets) of between 64 and 1518 octets, inclusive, but had either a bad FCS with an integral number of octets, (FCS Error) or a bad FCS with a non-integral number of octets (Alignment Error).
- **Undersize Packets** — Displays the total number of packets received that were less than 64 octets long (excluding framing bits, but including FCS octets) and were otherwise well formed.
- **Oversize Packets** — Displays the total number of packets received that were longer than 1518 octets (excluding framing bits, but including FCS octets) and were otherwise well formed.
- **Fragments** — Displays the total number of packets received that were less than 64 octets in length (excluding framing bits but including (FCS) with an integral number of octets (FCS Error) or a bad FCS with a non-integral number of octets (Alignment Error).
- **Jabbers** — Displays the total number of packets received that were longer than 1518 octets (excluding framing bits, but including FCS octets), and had either a bad Frame Check Sequence (FCS) with an integral number of octets (FCS Error), or a bad FCS with a non-integral number of octets (Alignment Error).
- **Collisions** — Displays the best estimate of the total number of collisions on this Ethernet segment.
- **Utilization** — Estimates the main physical layer network usage on an interface during the session sampling. The value is reflected hundredths of percent.

Viewing Statistics for a Specific History Entry

1. Open the **RMON History Table** page.
2. Select an entry in the **History Entry No.** field.

The entry's statistics display on screen.

Viewing RMON History Table Using CLI Commands

For information about the CLI commands that perform this function, see the following chapter in the *CLI Reference Guide*:

- RMON Commands

The following table summarizes the equivalent CLI commands for this feature.

Table 8-9. RMON History Table Command

CLI Command	Description
show rmon collection history	Displays interface-specific statistical network samplings
show rmon history	Displays RMON Ethernet Statistics history.

RMON Event Control

Use the **RMON Events Control** page to define RMON events. Events are used by RMON alarms to force some action when a threshold is crossed for a particular RMON counter. The event information can be stored in a log and/or sent as a trap to a trap receiver.

To display the page, click **Statistics/RMON → RMON → Event Control** in the tree view.

Figure 8-12. RMON Event Control

The screenshot shows the Dell OpenManage Switch Administrator interface. The top navigation bar includes 'Support', 'Help', 'About', and 'Log Out'. The main header displays the Dell logo and 'PowerConnect 6224P'. The breadcrumb trail is 'Statistics/RMON > RMON > Event Control'. The left sidebar shows a tree view with 'Home' selected. The main content area is titled 'Event Control' and contains a form with the following fields:

- Event Entry: A dropdown menu.
- Community: A text input field with a '(1 to 127 characters)' label.
- Description: A text input field with a '(1 to 127 characters)' label.
- Event Type: A dropdown menu with 'None' selected.
- Time: A text input field.
- Owner: A text input field with a '(1 to 127 characters)' label.

Below the form is a 'Remove' checkbox and an 'Apply Changes' button. In the top right corner of the form area, there are buttons for 'Print', 'Refresh', 'Add', and 'Show All'.

The RMON Event Control page contains the following fields:

- **Event Entry** — Selects the event.
- **Community** — Specifies the community to which the event belongs.

- **Description** — Describes the user-defined event.
- **Event Type** — Selects the event type. Possible values are:
 - **Log** — Event type is a log entry.
 - **Trap** — Event type is a trap.
 - **Log and Trap** — Event type is both a log entry and a trap.
 - **None** — There is no event.
- **Time** — Displays the time when the event occurred.
- **Owner** — Lists the switch or user that defined the event.
- **Remove** — Removes the event from the Events Table when checked.

Adding an RMON Event

1. Open the RMON Event Control page.
2. Click Add.

The Add an Event Entry page displays.

Figure 8-13. Add an Event Entry

Add an Event Entry	
Event Entry	2
Community	<input type="text"/>
Description	<input type="text"/>
Event Type	None
Owner	<input type="text"/>

3. Complete the fields on this page.
4. Click **Apply Changes**.
The event is added to the **RMON Event Table**, and the device is updated.

Modifying an RMON Event

1. Open the RMON Event Control page.
2. Click **Show All** to display the **Event Control Table** page.
3. Select the **Edit** check box in for the event entry to change.
4. Modify the fields on the page as needed.
5. Click **Apply Changes**.

The RMON Events Table entry is modified, and the device is updated.

Displaying the RMON Event Control Table

1. Open the RMON Event Control page.
2. Click Show All.

The Event Control Table displays.

Figure 8-14. Event Control Table

Event Entry	Community	Description	Event Type	Time	Owner	Remove	Edit
-------------	-----------	-------------	------------	------	-------	--------	------

Buttons: Print, Refresh, Apply Changes, Back

Removing RMON Event Entries

1. Open the RMON Event Control page.
2. Choose the event to remove from the drop-down menu in the **Event Entry** field and check **Remove**.
3. Click **Apply Changes**.

The table entry is removed, and the device is updated.

Defining Switch Events Using CLI Commands

For information about the CLI commands that perform this function, see the following chapter in the *CLI Reference Guide*:

- RMON Commands

The following table summarizes the equivalent CLI commands for this feature.

Table 8-10. RMON Event Control Command

CLI Command	Description
rmon event	Configures events.

RMON Event Log

Use the RMON Event Log page to display a list of RMON events.

To display the page, click **Statistics/RMON →RMON →Events Log** in the tree view.

Figure 8-15. RMON Event Log

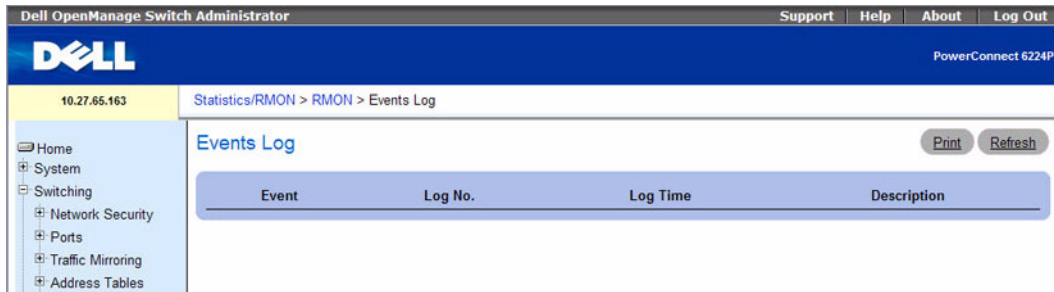

The **RMON Event Log** page contains the following fields:

- **Event** — Displays the RMON Events Log entry number.
- **Log No.** — Displays the log number.
- **Log Time** — Displays the time when the log entry was entered.
- **Description** — Describes the log entry.

Viewing the RMON Event Table Using CLI Commands

For information about the CLI commands that perform this function, see the following chapter in the *CLI Reference Guide*:

- RMON Commands

The following table summarizes the equivalent CLI commands for this feature.

Table 8-11. RMON Table Event Command

CLI Command	Description
show rmon events	Displays the RMON event table.

RMON Alarms

Use the **RMON Alarms** page to set network alarms. Alarms occur when certain thresholds are crossed for the configured RMON counters. The alarm triggers an event to occur. The events can be configured as part of the RMON Events group. For more information about events, see "RMON Event Log."

To display the page, click **Statistics/RMON → RMON → Alarms** in the tree view.

Figure 8-16. RMON Alarms

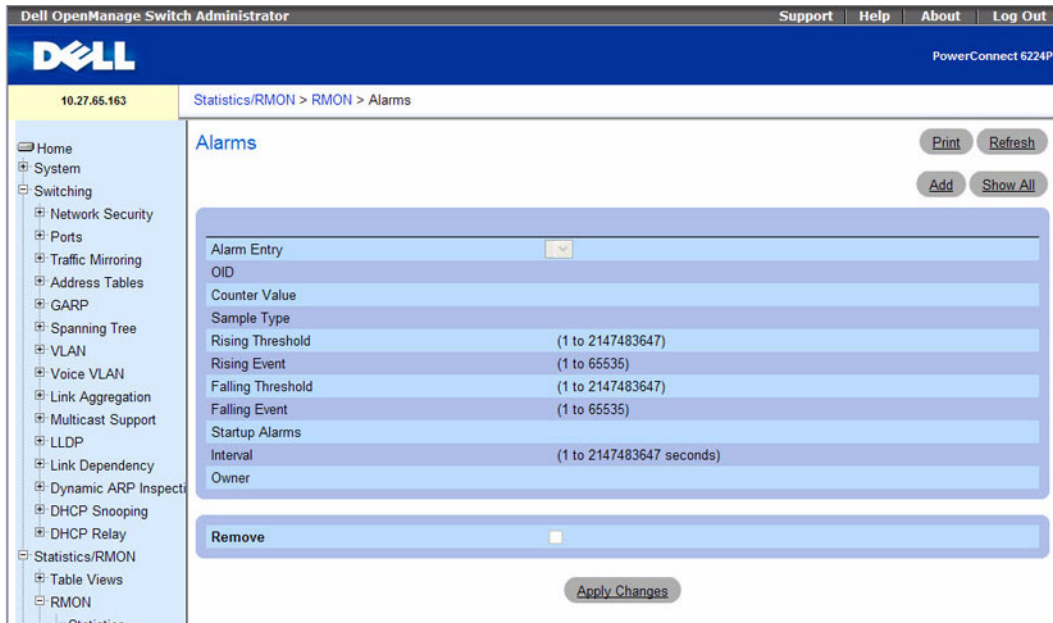

The RMON Alarms page contains the following fields:

- **Alarm Entry** — Selects a specific alarm from the drop-down menu.
- **OID** — Specifies the Object Identifier.
- **Counter Value** — Displays the number of selected events counted.
- **Sample Type** — Displays the sampling method for the selected variable and comparing the value against the thresholds. The possible field values are:
 - **Delta** — Subtracts the last sampled value from the current value. The difference in the values is compared to the threshold.
 - **Absolute** — Compares the values directly with the thresholds at the end of the sampling interval. This is the default.
- **Rising Threshold (0–2147483647)** — Displays the rising counter value that triggers the rising threshold alarm. The rising threshold is presented on top of the graph bars. Each monitored variable is designated a color. The default is 100.
- **Rising Event** — Displays the mechanism in which the alarms are reported, including a log, a trap, or both. When a log is selected, there is no saving mechanism either in the switch or in the management system. However, if the switch is not being reset, the event remains in the switch Log table. If a trap is selected, an SNMP trap is generated and reported through the Trap mechanism. The trap can be saved using the same mechanism.

- **Falling Threshold (0–2147483647)** — Displays the falling counter value that triggers the falling threshold alarm. The falling threshold is graphically presented on top of the graph bars. Each monitored variable is designated a color. The default is 20.
- **Falling Event** — Displays the mechanism in which the alarms are reported, including a log, a trap, or both. When a log is selected, there is no saving mechanism either in the switch or in the management system. However, if the switch is not being reset, the event remains in the switch Log table. If a trap is selected, an SNMP trap is generated and reported through the Trap mechanism. The trap can be saved using the same mechanism.
- **Startup Alarms** — Displays the type of event. Options are rising, rising-falling, and falling.
- **Interval (0–2147483647)**— Displays alarm interval time. The default is 100.
- **Owner** — Displays switch or user that defined the alarm.
- **Remove** — Removes an RMON Alarm when checked.

Adding an Alarm Table Entry

1. Open the RMON Alarms page.
2. Click Add.

The Add an Alarm Entry page displays.

Figure 8-17. Add an Alarm Entry

The screenshot shows a web-based configuration form titled "Add an Alarm Entry". At the top right, there are "Print" and "Refresh" buttons. The form itself is a table with the following fields:

Alarm Entry	1
OID	<input type="text"/>
Sample Type	Absolute
Rising Threshold (0 to 2147483647)	<input type="text"/>
Rising Event	<input type="text"/>
Falling Threshold (0 to 2147483647)	<input type="text"/>
Falling Event	<input type="text"/>
Startup Alarms	Rising
Interval (0 to 2147483647)	<input type="text"/> (Sec)
Owner	<input type="text"/>

At the bottom of the form, there are "Apply Changes" and "Back" buttons.

3. Complete the fields on this page as needed.
4. Click **Apply Changes**.
The RMON alarm is added, and the device is updated.

Displaying the Alarm Table

1. Open the RMON Alarms page.
2. Click Show All.

The left side of the RMON Alarms Table displays.

Figure 8-18. RMON Alarms Table

Alarm Entry	OID	Counter Value	Sample Type	Rising Threshold	Rising Event	Falling Threshold	Falling Event
1	1	0	Absolute	100	1	20	2

3. Click the right arrow at the bottom of the screen to view the right side of the table.

Removing One Alarm Table Entry

1. Open the RMON Alarms page.
2. Select an entry in the Alarm Entry drop-down menu.
3. Check the Remove check box and click Apply Changes.

The entry is removed, and the device is updated.

Removing Multiple Alarm Table Entries

1. Open the RMON Alarms page.
2. Click Show All.
3. Check Remove for each Alarm Entry to remove.
4. Click Apply Changes.

The entries are removed, and the device is updated.

Defining Switch Alarms Using CLI Commands

For information about the CLI commands that perform this function, see the following chapter in the *CLI Reference Guide*:

- RMON Commands

The following table summarizes the equivalent CLI commands for this feature.

Table 8-12. Alarm Configuration Commands

CLI Command	Description
rmon alarm	Configures alarm conditions.
show rmon alarm	display alarm configuration.
show rmon alarm-table	Displays the alarms summary table.

Charts

The **Chart** menu page contains links to web pages that allow you to chart statistics on a graph. To display the **Charts** menu page, click **Statistics/RMON** → **Charts** in the tree view. The **Charts** menu page contains links to the following features:

- Ports Statistics
- LAG Statistics

Ports Statistics

Use the **Ports Statistics** page to chart port-related statistics on a graph.

To display the page, click **Statistics/RMON** → **Charts** → **Ports** in the tree view.

Figure 8-19. Ports Statistics

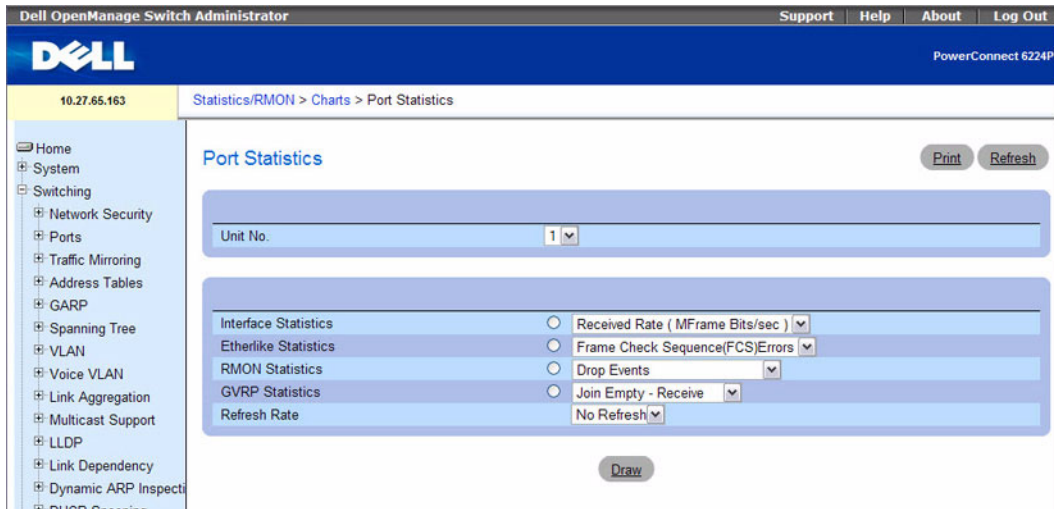

The **Ports Statistics** page contains the following fields:

- **Unit No.** — Selects the port to be displayed.
- **Interface Statistics** — Selects Interface Statistics when clicked, and specifies the type of interface statistics to graph from the drop-down menu. The default is Received Rate (MFrame Bits/sec).
- **Etherlike Statistics** — Selects Etherlike Statistics when clicked, and specifies the type of etherlike statistics to graph from the drop-down menu. The default is Frame Check Sequence (FCS) Errors.
- **RMON Statistics** — Selects RMON Statistics when clicked, and specifies the type of RMON statistics to graph from the drop-down menu. The default is Drop Events.

- **GVRP Statistics** — Selects GVRP Statistics when clicked, and specifies the type of GVRP statistics to graph from the drop-down menu. The default is Join Empty - Receive.
- **Refresh Rate** — Selects the amount of time that passes before statistics are refreshed. The possible field values are No Refresh, 15, 30 and 60 seconds. The default rate is No Refresh.

Displaying Port Statistics

1. Open the **Ports Statistics** page.
2. Select the port for which statistics will be charted.
3. Click the radio button associated with the statistics to chart.
4. Select the type of statistics from the related drop-down menu.
5. Select the desired refresh rate from the **Refresh Rate** drop-down menu.
6. Click **Draw**.

The selected statistics are charted on the graph.

Viewing Port Statistics Using CLI Commands

For information about the CLI commands that perform this function, see the following chapters in the *CLI Reference Guide*:

- System Management Commands
- RMON Commands
- GVRP Commands

The following table summarizes the equivalent CLI commands for this feature.

Table 8-13. Port Statistics Commands

CLI Command	Description
show interfaces counters	Display traffic seen by the interface.
show statistics ethernet	Displays detailed statistics for a specific port or for the entire switch.
show rmon statistics	Displays RMON Ethernet Statistics.
show gvrp statistics	Displays GVRP statistics.

LAG Statistics

Use the **LAG Statistics** page to chart LAG-related statistics on a graph.

To display the page, click **Statistics/RMON →Charts →LAGs** in the tree view.

Figure 8-20. LAG Statistics

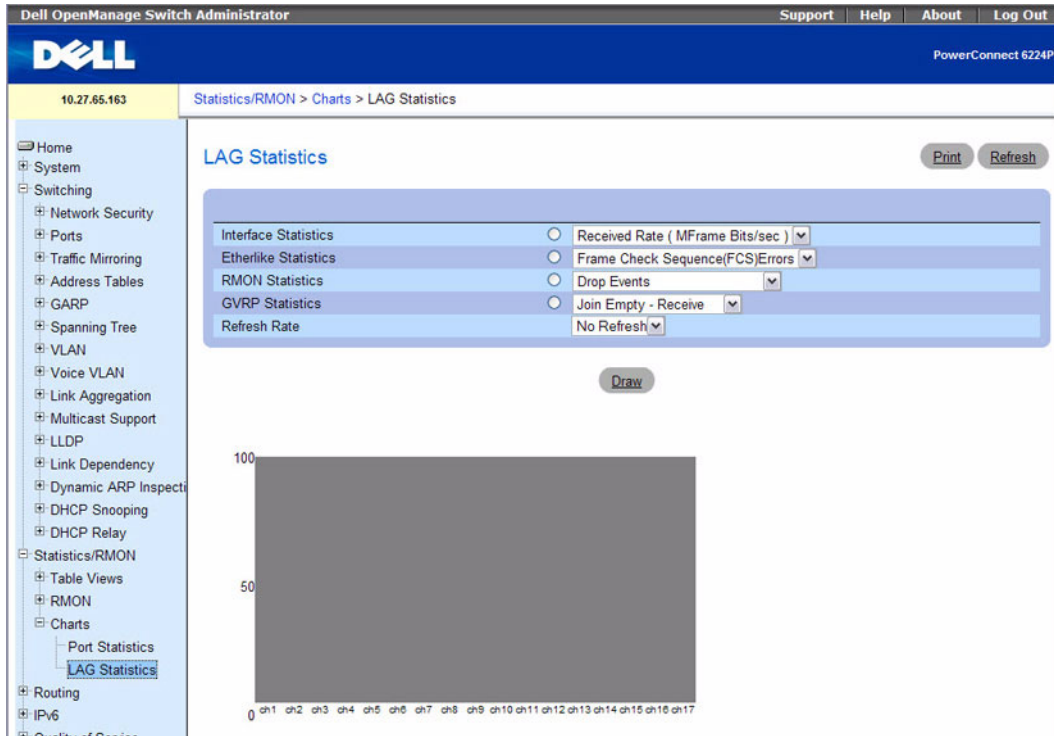

The LAG Statistics page contains the following fields:

- **Interface Statistics** — Selects Interface Statistics when clicked, and specifies the type of interface statistics to graph from the drop-down menu. The default is Received Rate.
- **Etherlike Statistics** — Selects Etherlike Statistics when clicked, and specifies the type of etherlike statistics to graph from the drop-down menu. The default is Frame Check Sequence Errors.
- **RMON Statistics** — Selects RMON Statistics when clicked, and specifies the type of RMON statistics to graph from the drop-down menu. The default is Drop Events.
- **GVRP Statistics** — Selects GVRP Statistics when clicked, and specifies the type of GVRP statistics to graph from the drop-down menu. The default is Join Empty - Receive.
- **Refresh Rate** — Selects the amount of time that passes before statistics are refreshed. The possible field values are No Refresh, 15, 30 and 60 seconds. The default rate is 15 seconds.

Displaying LAG Statistics

1. Open the LAG Statistics page.

2. Click the radio button associated with the statistics to chart.
3. Select the type of statistics from the related drop-down menu.
4. Select the desired refresh rate from the **Refresh Rate** drop-down menu.
5. Click **Draw**.

The selected statistics are charted on the graph.

Viewing LAG Statistics Using CLI Commands

For information about the CLI commands that perform this function, see the following chapters in the *CLI Reference Guide*:

- System Management Commands
- RMON Commands
- GVRP Commands

The following table summarizes the equivalent CLI commands for this feature.

The following table summarizes the equivalent CLI commands for this feature.

Table 8-14. LAG Statistics Commands

CLI Command	Description
show interfaces counters	Display traffic seen by the interface.
show statistics ethernet	Displays detailed statistics for a specific port or for the entire switch.
show rmon statistics	Displays RMON Ethernet Statistics.
show gvrp statistics	Displays GVRP statistics.

Configuring Routing

Overview

The PowerConnect 6200 Series supports the IP routing feature. Use the **Routing** menu page to configure routing on VLANs.

The **Routing** menu page contains links to the following features:

- ARP
- IP
- OSPF
- BOOTP/DHCP Relay Agent
- IP Helper
- RIP
- Router Discovery
- Router
- VLAN Routing
- VRRP
- Tunnels
- Loopbacks

 **NOTE:** CLI commands are not available for all the Routing pages.

When a packet enters the switch, the destination MAC address is checked to see if it matches any of the configured routing interfaces. If it does, then the device searches the host table for a matching destination IP address. If an entry is found, then the packet is routed to the host. If there is not a matching entry, then the switch performs a longest prefix match on the destination IP address. If an entry is found, then the packet is routed to the next hop. If there is no match, then the packet is routed to the next hop specified in the default route. If there is no default route configured, then the packet is passed to the PowerConnect 6200 Series software to be handled appropriately.

The routing table can have entries added either statically by the administrator or dynamically through RIP or OSPF. The host table can have entries added either statically by the administrator or dynamically through ARP.

ARP

The PowerConnect 6200 Series uses the ARP protocol to associate a layer 2 MAC address with a layer 3 IPv4 address. Additionally, the administrator can statically add entries into the ARP table.

ARP is a necessary part of the internet protocol (IP) and is used to translate an IP address to a media (MAC) address, defined by a local area network (LAN) such as Ethernet. A station needing to send an IP packet must learn the MAC address of the IP destination, or of the next hop router, if the destination is not on the same subnet. This is achieved by broadcasting an ARP request packet, to which the intended recipient responds by unicasting an ARP reply containing its MAC address. Once learned, the MAC address is used in the destination address field of the layer 2 header prepended to the IP packet.

The ARP cache is a table maintained locally in each station on a network. There are no specific requirements for the construction or maintenance of this cache, but at a minimum it needs to contain the information learned from processing ARP protocol packets, which for Ethernet are denoted by an 0x0806 EtherType field. ARP cache entries are learned by examining the source information in the ARP packet payload fields, regardless of whether it is an ARP request or response. Thus, when an ARP request is broadcast to all stations on a LAN segment or virtual LAN (VLAN), every recipient has the opportunity to store the sender's IP and MAC address in their respective ARP cache. The ARP response, being unicast, is normally seen only by the requestor, who stores the sender information in its ARP cache. Newer information always replaces existing content in the ARP cache.

The ARP cache can have between 256 and 896 entries. When multiple network interfaces are supported by a device, as is typical of a router, either a single ARP cache is used for all interfaces, or a separate cache is maintained per interface. While the latter approach is useful when network addressing is not unique per interface, this is not the case for Ethernet MAC address assignment so a single ARP cache is employed.

Devices can be moved in a network, which means the IP address that was at one time associated with a certain MAC address is now found using a different MAC, or may have disappeared from the network altogether (i.e., it has been reconfigured, disconnected, or powered off). This leads to stale information in the ARP cache unless entries are updated in reaction to new information seen on the network, periodically refreshed to determine if an address still exists, or removed from the cache if the entry has not been identified as a sender of an ARP packet during the course of an ageout interval, usually specified through configuration.

The **ARP** menu page contains links to web pages that configure and display ARP detail. To display this page, click **Routing** → **ARP** in the tree view. Following are the web pages accessible from this menu page:

- ARP Create
- ARP Table Configuration

ARP Create

Use the **ARP Create** page to add an entry to the Address Resolution Protocol table.

To display the page, click **Routing** → **ARP** → **ARP Create** in the tree view.

Figure 9-1. ARP Create

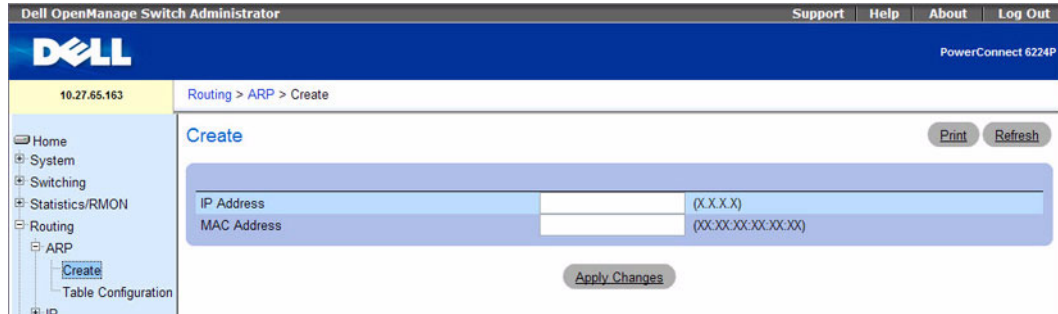

The ARP Create page contains the following fields:

- **IP Address** — Enter the IP address you want to add. It must be the IP address of a device on a subnet attached to one of the switch's existing routing interfaces.
- **MAC Address** — The unicast MAC address of the device. Enter the address as six two-digit hexadecimal numbers separated by colons, for example 00:06:29:32:81:40.

Adding an Entry to the ARP Table

1. Open the ARP Create page.
2. Specify the addresses to be associated.
3. Click **Apply Changes**.

The addresses are now in the ARP cache.

Adding Entries to the ARP Table Using CLI Commands

For information about the CLI command that performs this function, see the following chapter in the *CLI Reference Guide*:

- ARP Commands

The following table summarizes the equivalent CLI commands for this feature.

Table 9-1. ARP Create Commands

CLI Command	Description
arp	Creates an Address Resolution Protocol (ARP) entry.
ip proxy-arp	Enables proxy ARP on a router interface.

ARP Table Configuration

Use this page to change the configuration parameters for the Address Resolution Protocol Table. You can also use this screen to display the contents of the table.

To display the page, click **Routing** → **ARP** → **ARP Table Configuration** in the tree view.

Figure 9-2. ARP Table Configuration

The screenshot shows the Dell OpenManage Switch Administrator interface. The breadcrumb navigation is **Routing > ARP > Table Configuration**. The left sidebar shows a tree view with **Routing > ARP > Table Configuration** selected. The main content area is titled **Table Configuration** and contains the following configuration fields:

Age Time	1200	(15 to 21600 seconds)
Response Time	1	(1 to 10 seconds)
Retries	4	(0 to 10)
Cache Size	1024	(256 to 1024)
Dynamic Renew	Disable	
Total Entry Count	0	
Peak Total Entries	0	
Active Static Entries	0	
Configured Static Entries	0	
Maximum Static Entries	64	
Remove From Table	None	

Below the configuration fields is a table with the following columns: **IP Address**, **MAC Address**, **Vlan Id**, **Type**, and **Age**. An **Apply Changes** button is located below the table.

The **ARP Table Configuration** page contains the following fields:

- **Age Time (secs)** — Enter the value you want the switch to use for the ARP entry ageout time. You must enter a valid integer, which represents the number of seconds it takes for an ARP entry to age out. The range for this field is 15 to 21600 seconds. The default value for Age Time is 1200 seconds.
- **Response Time (secs)** — Enter the value you want the switch to use for the ARP response timeout. You must enter a valid integer, which represents the number of seconds the switch waits for a response to an ARP request. The range for this field is 1 to 10 seconds. The default value for Response Time is 1 second.
- **Retries** — Enter an integer which specifies the maximum number of times an ARP request is retried. The range for this field is 0 to 10. The default value for Retries is 4.
- **Cache Size** — Enter an integer which specifies the maximum number of entries for the ARP cache. The range for this field is 256 to 896. The default value for Cache Size is 896.

- **Dynamic Renew** — This controls whether the ARP component automatically attempts to renew ARP Entries of type Dynamic when they age out. The default setting is Enable.
- **Total Entry Count** — Total number of Entries in the ARP table.
- **Peak Total Entries** — Highest value reached by Total Entry Count. This counter value is restarted whenever the ARP table Cache Size value is changed.
- **Active Static Entries** — Total number of Active Static Entries in the ARP table.
- **Configured Static Entries** — Total number of Configured Static Entries in the ARP table.
- **Maximum Static Entries** — Maximum number of Static Entries that can be defined.
- **Remove from Table** — Allows you to remove certain entries from the ARP Table. The choices listed specify the type of ARP Entry to be deleted:
 - All Dynamic Entries
 - All Dynamic and Gateway Entries
 - Specific Dynamic Gateway Entry
 - Specific Static Entry

The ARP Table displays at the bottom of the page, and contains the following fields:

- **IP Address** — The IP address of a device on a subnet attached to one of the switch's routing interfaces.
- **MAC Address** — The unicast MAC address for the device. The format is six two-digit hexadecimal numbers separated by colons, for example 00:06:29:32:81:40.
- **VLAN ID** — The routing interface associated with the ARP entry.
- **Type** — The type of the ARP entry.
- **Age** — Age since the entry was last refreshed in the ARP Table. The format is hh:mm:ss.

Configuring ARP Table

1. Open the **ARP Table Configuration** page.
2. Change parameters as needed.
3. Click **Apply Changes**.
Changes are saved, and the ARP table is updated.

Configuring ARP Table with CLI Commands

For information about the CLI commands that perform this function, see the following chapter in the *CLI Reference Guide*:

- ARP Commands

The following table summarizes the equivalent CLI commands for this feature.

Table 9-2. ARP Table Commands

CLI Command	Description
arp cachesize	Configures the maximum number of entries in the ARP cache.
arp dynamicrenew	Enables the ARP component to automatically renew dynamic ARP entries when they age out.
arp purge	Causes the specified IP address to be removed from the ARP cache.
arp resptime	Configures the ARP request response timeout.
arp retries	Configures the ARP count of maximum request for retries.
arp timeout	Configures the ARP entry age-out time.
clear arp-cache	Removes all ARP entries of type dynamic from the ARP cache.
clear arp-cache management	Removes all entries from the ARP cache learned from the management port.
show arp	Displays the Address Resolution Protocol (ARP) cache.
show arp brief	Displays the brief Address Resolution Protocol (ARP) table information.

IP

The **IP** menu page contains links to web pages that configure and display IP routing data. To display this page, click **Routing** → **IP** in the tree view. Following are the web pages accessible from this menu page:

- IP Configuration
- IP Statistics
- IP Interface Configuration

IP Configuration

Use the **IP Configuration** page to configure routing parameters for the switch as opposed to an interface. The IP configuration settings allow you to enable or disable the generation of various types of ICMP messages.

To display the page, click **Routing** → **IP** → **Configuration** in the tree view.

Figure 9-3. IP Configuration

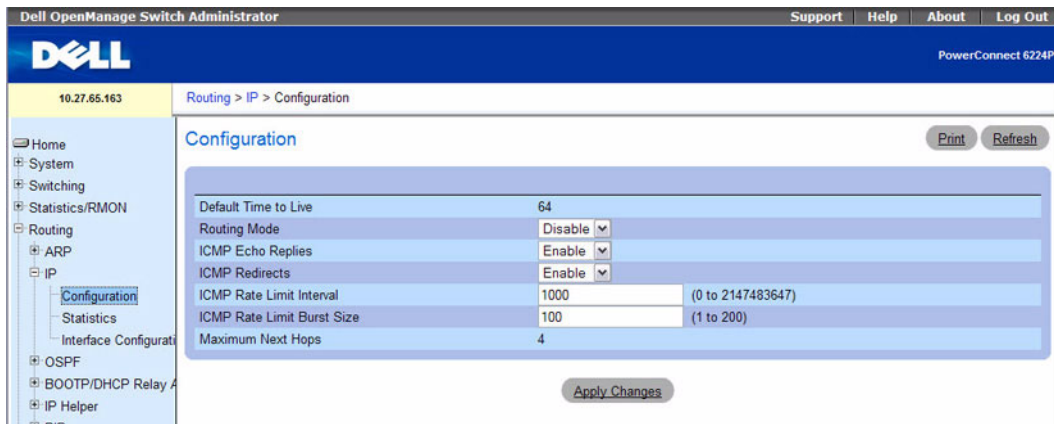

The **IP Configuration** page contains the following fields:

- **Default Time to Live** — The default value inserted into the Time-To-Live field of the IP header of datagrams originated by the switch, if a TTL value is not supplied by the transport layer protocol.
- **Routing Mode** — Select Enable or Disable from the drop-down menu. You must enable routing for the switch before you can route through any of the interfaces. Routing is also enabled or disabled per VLAN interface. The default value is Disable.
- **ICMP Echo Replies** — Select Enable to allow the switch to generate ECHO reply messages. Select Disable to prevent the switch from generating ICMP echo replies.

- **ICMP Redirects** — Select Enable to allow the switch to generate ICMP redirect messages. Select Disable to prevent the switch from generating ICMP redirect messages. The ICMP Redirect feature is also configurable on each interface.
- **ICMP Rate Limit Interval** — To control the ICMP error packets, you can specify the number of ICMP error packets that are allowed per burst interval. By default, the rate limit is 100 packets per second, i.e. the burst interval is 1000 milliseconds. To disable ICMP rate limiting, set this field to zero. The valid rate interval range is 0 to 2147483647 milliseconds.
- **ICMP Rate Limit Burst Size** — To control the ICMP error packets, you can specify the number of ICMP error packets that are allowed per burst interval. By default, the rate limit is 100 packets.
- **Maximum Next Hops** — The maximum number of hops supported by the switch. This is a compile-time constant.

Configuring IP Routing Parameters

1. Open the **IP Configuration** page.
2. Change parameters as needed.
3. Click **Apply Changes**.

Changes are saved, and routing parameters are updated.

Configuring IP Routing Parameters with CLI Command

For information about the CLI commands that perform this function, see the following chapters in the *CLI Reference Guide*:

- IP Routing Commands
- VLAN Commands

The following table summarizes the equivalent CLI commands for this feature.

Table 9-3. IP Configuration Commands

CLI Command	Description
ip icmp error-interval	Limits the rate at which IPv4 ICMP error messages are sent.
ip redirects	Enables the generation of ICMP Redirect messages.
ip routing	Globally enables IPv4 routing on the router.
show ip brief	Displays all the summary information of the IP.
show ip protocols	Displays the parameters and current state of the active routing protocols.

IP Statistics

The statistics reported on the **IP Statistics** page are as specified in RFC 1213.

To display the page, click **Routing** → **IP** → **Statistics** in the tree view.

Figure 9-4. IP Statistics

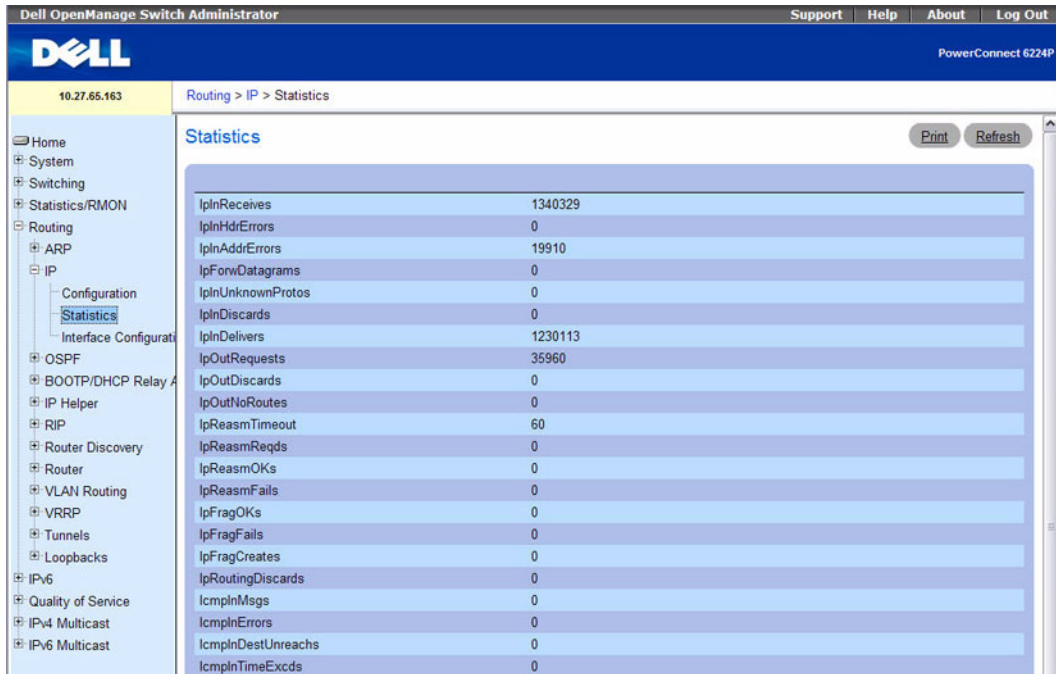

Field	Value
IplnReceives	1340329
IplnHdrErrors	0
IplnAddrErrors	19910
IpForwDatagrams	0
IplnUnknownProtos	0
IplnDiscards	0
IplnDelivers	1230113
IpOutRequests	35960
IpOutDiscards	0
IpOutNoRoutes	0
IpReasmTimeout	60
IpReasmReqds	0
IpReasmOKs	0
IpReasmFails	0
IpFragOKs	0
IpFragFails	0
IpFragCreates	0
IpRoutingDiscards	0
IcmplnMsgs	0
IcmplnErrors	0
IcmplnDestUnreachs	0
IcmplnTimeExcds	0

The IP Statistics page contains the following fields:

- **IpInReceives** — The total number of input datagrams received from interfaces, including those received in error.
- **IpInHdrErrors** — The number of input datagrams discarded due to errors in their IP headers, including bad checksums, version number mismatch, other format errors, time-to-live exceeded, errors discovered in processing their IP options, etc.
- **IpInAddrErrors** — The number of input datagrams discarded because the IP address in their IP header's destination field was not a valid address to be received at this entity. This count includes invalid addresses (for example, 0.0.0.0) and addresses of unsupported Classes (for example, Class E). For entities which are not IP Gateways and therefore do not forward datagrams, this counter includes datagrams discarded because the destination address was not a local address.
- **IpForwDatagrams** — The number of input datagrams for which this entity was not their final IP destination, as a result of which an attempt was made to find a route to forward them to that final destination. In entities which do not act as IP Gateways, this counter includes only those packets which were Source-Routed through this entity, and the Source-Route option processing was successful.
- **IpInUnknownProtos** — The number of locally-addressed datagrams received successfully but discarded because of an unknown or unsupported protocol.

- **IpInDiscards** — The number of input IP datagrams for which no problems were encountered to prevent their continued processing, but which were discarded (for example, for lack of buffer space). Note that this counter does not include any datagrams discarded while awaiting re-assembly.
- **IpInDelivers** — The total number of input datagrams successfully delivered to IP user-protocols (including ICMP).
- **IpOutRequests** — The total number of IP datagrams which local IP user-protocols (including ICMP) supplied to IP in requests for transmission. Note that this counter does not include any datagrams counted in ipForwDatagrams.
- **IpOutDiscards** — The number of output IP datagrams for which no problem was encountered to prevent their transmission to their destination, but which were discarded (for example, for lack of buffer space). Note that this counter would include datagrams counted in ipForwDatagrams if any such packets met this (discretionary) discard criterion.
- **IpOutNoRoutes** — The number of IP datagrams discarded because no route could be found to transmit them to their destination. Note that this counter includes any packets counted in ipForwDatagrams which meet this 'no-route' criterion and any datagrams which a host cannot route because all of its default gateways are down.
- **IpReasmTimeout** — The maximum number of seconds which received fragments are held while they are awaiting reassembly at this entity.
- **IpReasmReqds** — The number of IP fragments received which needed to be reassembled at this entity.
- **IpReasmOKs** — The number of IP datagrams successfully re-assembled.
- **IpReasmFails** — The number of failures detected by the IP re-assembly algorithm (for whatever reason: timed out, errors, and so on). Note that this is not necessarily a count of discarded IP fragments since some algorithms can lose track of the number of fragments by combining them as they are received.
- **IpFragOKs** — The number of IP datagrams that have been successfully fragmented at this entity.
- **IpFragFails** — The number of IP datagrams that have been discarded because they needed to be fragmented at this entity but could not be, for example, because their Don't Fragment flag was set.
- **IpFragCreates** — The number of IP datagram fragments that have been generated as a result of fragmentation at this entity.
- **IpRoutingDiscards** — The number of routing entries which were chosen to be discarded even though they are valid. One possible reason for discarding such an entry could be to free-up buffer space for other routing entries.
- **IcmpInMsgs** — The total number of ICMP messages which the entity received. Note that this counter includes all those counted by icmpInErrors.
- **IcmpInErrors** — The number of ICMP messages which the entity received but determined as having ICMP-specific errors (bad ICMP checksums, bad length, etc.).
- **IcmpInDestUnreachs** — The number of ICMP Destination Unreachable messages received.
- **IcmpInTimeExcds** — The number of ICMP Time Exceeded messages received.

- **IcmpInParmProbs** — The number of ICMP Parameter Problem messages received.
- **IcmpInSrcQuenchs** — The number of ICMP Source Quench messages received.
- **IcmpInRedirects** — The number of ICMP Redirect messages received.
- **IcmpInEchos** — The number of ICMP Echo (request) messages received.
- **IcmpInEchoReps** — The number of ICMP Echo Reply messages received.
- **IcmpInTimestamps** — The number of ICMP Timestamp (request) messages received.
- **IcmpInTimestampReps** — The number of ICMP Timestamp Reply messages received.
- **IcmpInAddrMasks** — The number of ICMP Address Mask Request messages received.
- **IcmpInAddrMaskReps** — The number of ICMP Address Mask Reply messages received.
- **IcmpOutMsgs** — The total number of ICMP messages which this entity attempted to send. Note that this counter includes all those counted by icmpOutErrors.
- **IcmpOutErrors** — The number of ICMP messages which this entity did not send due to problems discovered within ICMP such as a lack of buffers. This value should not include errors discovered outside the ICMP layer such as the inability of IP to route the resultant datagram. In some implementations there may be no types of error which contribute to this counter's value.
- **IcmpOutDestUnreachs** — The number of ICMP Destination Unreachable messages sent.
- **IcmpOutTimeExcds** — The number of ICMP Time Exceeded messages sent.
- **IcmpOutParmProbs** — The number of ICMP Parameter Problem messages sent.
- **IcmpOutSrcQuenchs** — The number of ICMP Source Quench messages sent.
- **IcmpOutRedirects** — The number of ICMP Redirect messages sent. For a host, this object is always zero, since hosts do not send redirects.
- **IcmpOutEchos** — The number of ICMP Echo (request) messages sent.
- **IcmpOutEchoReps** — The number of ICMP Echo Reply messages sent.
- **IcmpOutTimestamps** — The number of ICMP Timestamp (request) messages.
- **IcmpOutTimestampReps** — The number of ICMP Timestamp Reply messages sent.
- **IcmpOutAddrMasks** — The number of ICMP Address Mask Request messages sent.
- **IcmpOutAddrMaskReps** — The number of ICMP Address Mask Reply messages sent.

Refreshing IP Statistics

1. Open the IP Statistics page.
2. Click Refresh.

The screen displays with the present state of the data in the switch.

Displaying IP Statistics Using CLI Commands

For information about the CLI command that performs this function, see the following chapter in the *CLI Reference Guide*:

- IP Routing Commands

The following table summarizes the equivalent CLI commands for this feature.

Table 9-4. IP Statistics Command

CLI Command	Description
show ip stats	Displays IP statistical information

IP Interface Configuration

Use the **IP Interface Configuration** page to update IP interface data for this switch. The IP interface configuration includes the ability to configure the bandwidth, Destination Unreachable messages, and ICMP Redirect messages.

To display the page, click **Routing** → **IP** → **Interface Configuration** in the tree view.

Figure 9-5. IP Interface Configuration

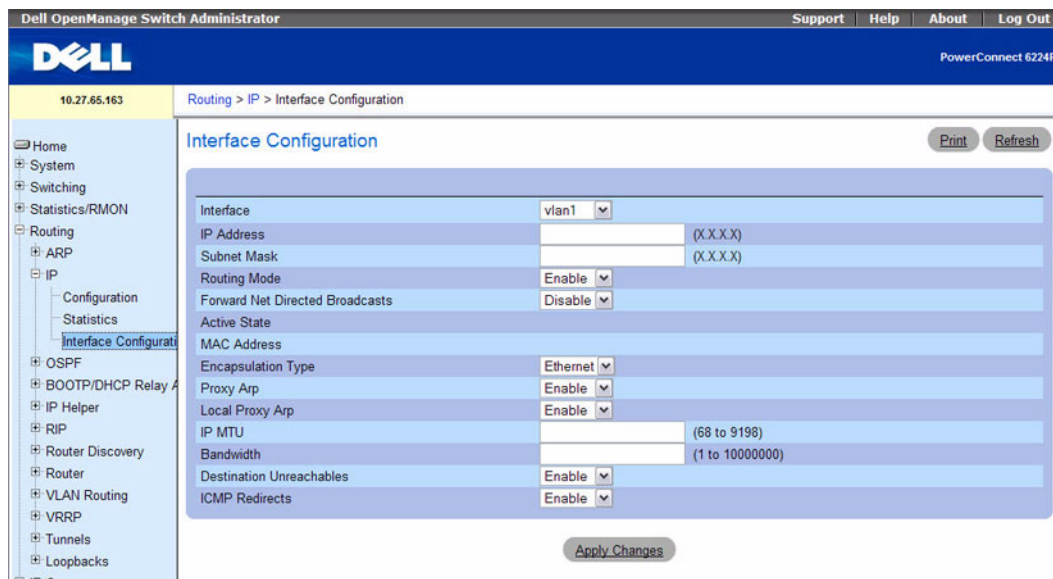

The **IP Interface Configuration** page contains the following fields:

- **Interface** — Select the interface to configure from the drop-down menu. The drop-down menu contains loopback interfaces and VLANs created from the **Switching** → **VLAN** → **VLAN Membership** → **Add** page.

- **IP Address** — Enter the IP address for the interface.
- **Subnet Mask** — Enter the subnet mask for the interface. This is also referred to as the subnet/network mask, and defines the portion of the interface's IP address that is used to identify the attached network.
- **Routing Mode** — Setting this enables or disables routing for an interface. The default value is **Enable**.
- **Forward Net Directed Broadcasts** — Select how network directed broadcast packets should be handled. If you select **Enable** from the drop-down menu network directed broadcasts are forwarded. If you select **Disable** they are dropped. The default value is **Disable**.
- **Active State** — The state of the specified interface is either **Active** or **Inactive**. An interface is considered active if the link is up and it is in forwarding state.
- **MAC Address** — The burned-in physical address of the specified interface. The format is six two-digit hexadecimal numbers separated by colons, for example 00:06:29:32:81:40. This value is valid for physical interfaces. For logical interfaces, such as VLAN routing interfaces, the field displays the system MAC address.
- **Encapsulation Type** — Select the link layer encapsulation type for packets transmitted from the specified interface from the drop-down menu. The possible values are **Ethernet** and **SNAP**. The default is **Ethernet**.
- **Proxy ARP** — Select to **Disable** or **Enable** proxy ARP for the specified interface from the drop-down menu.
- **Local Proxy ARP** — Select to **Disable** or **Enable** Local Proxy ARP for the specified interface from the drop-down menu.
- **IP MTU** — Specifies the maximum transmission unit (MTU) size of IP packets sent on an interface. Valid range is (68 to 9198). The default value is 1500.
- **Bandwidth** — Specifies the configured bandwidth on this interface for the OSPF link cost calculation. This setting does not affect the actual speed of an interface, and the speed of the interface is communicated to higher level protocols. The valid range is (1 to 10000000).
- **Destination Unreachables** — Select **Enable** to allow the interface to generate ICMP Destination Unreachable messages on this interface. Select **Disable** to prevent the interface from generating ICMP Destination Unreachable messages on this interface. By default, the Destination Unreachables mode is **Enable**.
- **ICMP Redirects** — Select **Enable** to allow the interface to generate ICMP redirect messages. Select **Disable** to prevent the interface from generating ICMP redirect messages. The ICMP Redirect feature is also configurable globally. If the ICMP Redirect feature is enabled on the interface, it must be enabled globally in order for the interface to generate ICMP redirect messages.

Modifying an IP Interface

1. Open the **IP Interface Configuration** page.
2. Change values as needed.

3. Click Apply Changes.

Changes are saved, and the IP Interface is updated.

IP Interface Configuration CLI Commands

For information about the CLI commands that perform this function, see the following chapters in the *CLI Reference Guide*:

- IP Addressing Commands
- IP Routing Commands
- ARP Commands

The following table summarizes the equivalent CLI commands for this feature.

Table 9-5. IP Interface Configuration Commands

CLI Command	Description
routing	Enables IPv4 and IPv6 routing for an interface.
encapsulation	Configures the link layer encapsulation type for the packet.
ip address	Configures an IP address on an interface.
ip mtu	Sets the IP Maximum Transmission Unit (MTU) on a routing interface.
ip netdirbcast	Enables the forwarding of network-directed broadcasts.
show ip interface	Displays all pertinent information about the IP interface.

OSPF

The Open Shortest Path First (OSPF) routing protocol is an Interior Gateway Protocol (IGP). Every OSPF router builds a shortest path tree of all the routers and networks in the domain. Routing information is propagated in Link State Update packets both periodically and in the event of network topology changes. This information is received, assimilated and stored in the OSPF databases of individual routers. An integral piece of information in the database exchange is the number and IP Addresses of the interfaces that are associated with the router. OSPF treats secondary IP Addresses as stub networks attached to the router. Hence though these networks are advertised in the OSPF routing domain, neighbor adjacencies are never established on secondary addresses. It is also important to note here that all secondary IP Addresses must be in the same area as the primary IP Address so that they get advertised by OSPF. This is always true in the case of the PowerConnect 6200 Series software implementation because the area configuration is on a per interface basis as against a per network basis.

The **OSPF** menu page contains links to web pages that configure and display OSPF parameters and data. To display this page, click **Routing** → **OSPF** in the tree view. Following are the web pages accessible from this menu page:

- OSPF Configuration
- Area Configuration
- Stub Area Summary
- Area Range Configuration
- Interface Statistics
- Interface Configuration
- Neighbor Table
- Neighbor Configuration
- Link State Database
- Virtual Link Configuration
- Virtual Link Summary
- Route Redistribution Configuration
- Route Redistribution Summary
- Nonstop Forwarding OSPF Graceful Restart

OSPF Configuration

Use the **OSPF Configuration** page to enable OSPF on a router and to configure the related OSPF settings.

To display the page, click **Routing** → **OSPF** → **Configuration** in the tree view.

Figure 9-6. OSPF Configuration

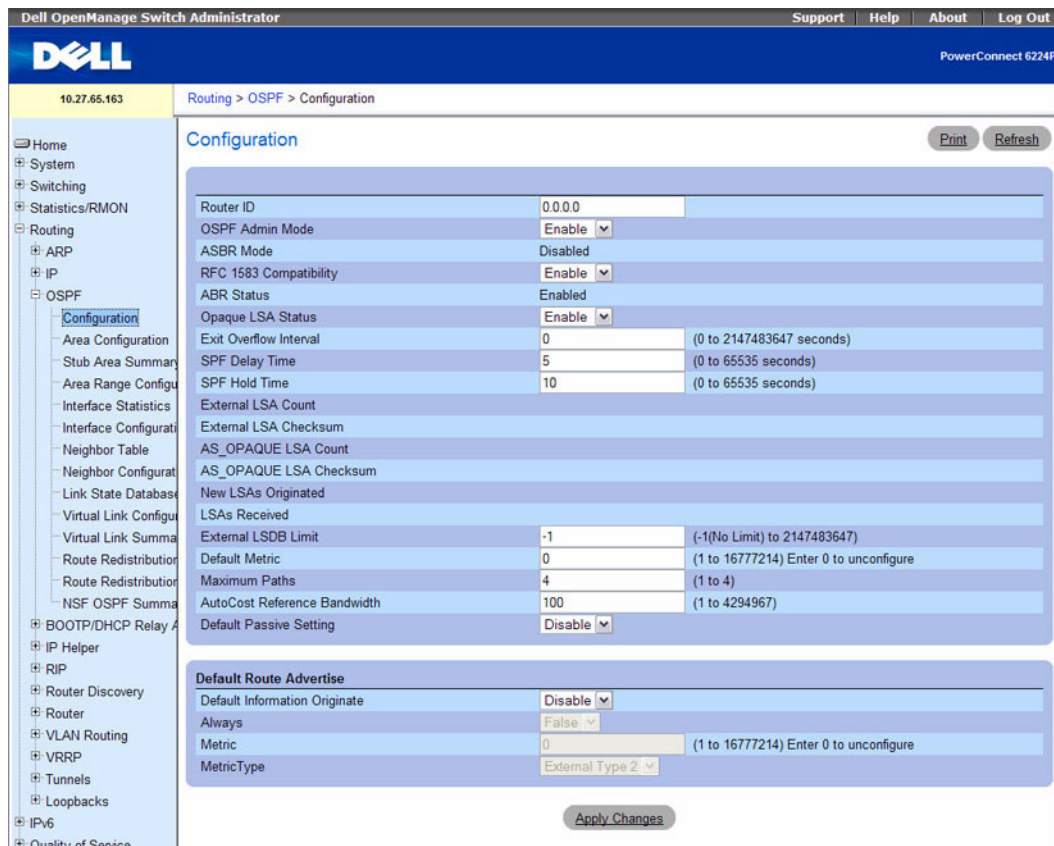

The OSPF Configuration page contains the following fields:

- **Router ID** — The 32-bit integer in dotted decimal format that uniquely identifies the router within the autonomous system (AS). If you want to change the Router ID you must first disable OSPF. After you set the new Router ID, you must re-enable OSPF to have the change take effect. The default value is 0.0.0.0, although this is not a valid Router ID.
 - **OSPF Admin Mode** — Select Enable or Disable from the drop-down menu. If you select Enable OSPF is activated for the switch. The default value is Disable. You must configure a Router ID before OSPF can become operational.
- NOTE:** Once OSPF is initialized on the router, it remains active until the router is reset.
- **ASBR Mode** — Reflects whether the ASBR mode is Enabled or Disabled. Enable implies that the router is an autonomous system border router. Router automatically becomes an ASBR when it is configured to redistribute routes learnt from other protocol.

- **RFC 1583 Compatibility** — Select Enable or Disable from the drop-down menu to specify the preference rules that are used when choosing among multiple AS-external-LSAs advertising the same destination. If you select Enable, the preference rules are those defined by RFC 1583. If you select Disable, the preference rules are those defined in Section 16.4.1 of the OSPF-2 standard (RFC 2328), which prevent routing loops when AS-external-LSAs for the same destination have been originated from different areas. The default value is Enable. To prevent routing loops, you should select Disable, but only if all OSPF routers in the routing domain are capable of operating according to RFC 2328.
- **ABR Status** — The values of this are Enabled or Disabled. Enabled implies that the router is an area border router. Disabled implies that it is not an area border router.
- **Opaque LSA Status** — Set this parameter to Enable if OSPF should store and flood opaque LSAs. An opaque LSA is used for flooding user-defined information within an OSPF router domain.
- **Exit Overflow Interval** — Enter the number of seconds that, after entering overflow state, the router should wait before attempting to leave overflow state. This allows the router to again originate non-default AS-external-LSAs. If you enter 0, the router does not leave Overflow State until restarted. The range is 0 to 2147483647 seconds.
- **SPF DelayTime** — Enter the number of seconds, Delay time (in seconds) is the time between when OSPF receives a topology change and when it starts an SPF calculation. It can be an integer from 0 to 65535. The default time is 5 seconds. A value of 0 means that there is no delay; that is, the SPF calculation is started immediately.
- **SPF HoldTime** — Enter the number of seconds, minimum time (in seconds) between two consecutive SPF calculations. It can be an integer from 0 to 65535. The default time is 10 seconds. A value of 0 means that there is no delay; that is, two SPF calculations can be done, one immediately after the other.
- **External LSA Count** — The number of external (LS type 5) LSAs (link state advertisements) in the link state database.
- **External LSA Checksum** — The sum of the LS checksums of the external LSAs (link state advertisements) contained in the link-state database. This sum can be used to determine if there has been a change in a router's link state database, and to compare the link-state databases of two routers. This value is in hexadecimal.
- **AS_OPAQUE LSA Count** — Shows the number of opaque LSAs with domain wide flooding scope.
- **AS_OPAQUE LSA Checksum** — Shows the sum of the LS checksums of the opaque LSAs with domain wide flooding scope. This sum can be used to determine if there has been a change in a router's link state database, and to compare the link-state databases of two routers. This value is in hexadecimal.
- **New LSAs Originated** — In any given OSPF area, a router originates several LSAs. Each router originates a router-LSA. If the router is also the Designated Router for any of the area's networks, it originates network-LSAs for those networks. This value represents the number of LSAs originated by this router.
- **LSAs Received** — The number of LSAs (link state advertisements) received that were determined to be new instantiations. This number does not include newer instantiations of self-originated LSAs.

- **External LSDB Limit** — The maximum number of AS-External-LSAs that can be stored in the database. A value of -1 implies there is no limit on the number that can be saved. The valid range of values is -1 to 2147483647.
- **Default Metric** — Sets a default for the metric of redistributed routes. This field displays the default metric if one has already been set or blank if not configured earlier. The valid values are 1 to 16777214. Enter 0 to unconfigure.
- **Maximum Paths** — Configure the maximum number of paths that OSPF can report to a given destination. The valid values are 1 to 4.
- **AutoCost Reference Bandwidth** — This field configures the value that OSPF uses in calculating the default metric for an interface. OSPF calculates the link cost of each interface as $\text{Cost} = (\text{Reference Bandwidth in Mbps}) / (\text{Interface Bandwidth})$. For example, setting this value to 1000 Mbps would cause all 1-Gbps interfaces to have a default cost of $1000/1000 = 1$. For 100 Mbps interfaces, the default cost would be $1000/100 = 10$.
- **Default Passive Setting** — Enable this setting to make all interfaces on the switch operate in passive mode passive. Configuring this field overwrites any present interface level passive mode setting. OSPF does not form adjacencies on passive interfaces, but it does advertise attached networks as stub networks. Interfaces are not passive by default. It is common to configure an OSPF interface to be passive when OSPF must advertise the subnets configured on the interface, but routers on the subnet belong to other OSPF domains, such as an OSPFv3 router at the end of a 6to4 tunnel.

Default Route Advertise

- **Default Information Originate** — Enable or Disable Default Route Advertise.
- **Always** — Sets the router advertise 0.0.0.0/0.0.0.0 when set to True.
- **Metric** — Specifies the metric of the default route. The valid values are 1 to 16777214. Enter 0 to unconfigure.
- **Metric Type** — Sets the metric type of the default route. Options are External Type 1 and External Type 2. External Type 2 is the default.

Modifying an OSPF Configuration

1. Open the **OSPF Configuration** page.
2. Change values as needed.
3. Click **Apply Changes**.

Changes are saved, and the OSPF Interface is updated.

OSPF Configuration CLI Commands

For information about the CLI commands that perform this function, see the following chapter in the *CLI Reference Guide*:

- OSPF Commands

The following table summarizes the equivalent CLI commands for this feature.

Table 9-6. OSPF Global Commands

CLI Command	Description
auto-cost	Changes the reference bandwidth used in computing link cost.
bandwidth	Changes the bandwidth used in computing link cost.
capability opaque	Enables Opaque Capability on the router.
clear ip ospf	Resets specific OSPF states.
default-information originate	Controls the advertisement of default routes.
default-metric	Sets a default for the metric of distributed routes.
distance ospf	Sets the route preference value of OSPF in the router.
enable	Resets the default administrative mode of OSPF in the router (active).
exit-overflow-interval	Configures the exit overflow interval for OSPF.
external-lsdb-limit	Configures the external LSDB limit for OSPF.
ip ospf mtu-ignore	Disables OSPF maximum transmission unit (MTU) mismatch detection.
maximum-paths	Sets the number of paths that OSPF can report for a given destination.
passive-interface default	Enables the global passive mode by default for all interfaces.
router-id	Sets a 4-digit dotted-decimal number uniquely identifying the router OSPF ID.
router ospf	Enters Router OSPF mode.
show ip ospf	Displays information relevant to the OSPF router.
show ip ospf abr	Displays the internal OSPF routing table entries to Area Border Routers (ABR).
show ip ospf asbr	Displays the internal OSPF routing table entries to Autonomous System Boundary Routes (ASBR).
show ip ospf statistics	Displays information about recent Shortest Path First (SPF) calculations.
timers spf	Configures the SPF delay and hold time.
trapflags	Enables OSPF traps.
1583compatibility	Enables OSPF 1583 compatibility.

Area Configuration

The **OSPF Area Configuration** page lets you create a Stub area configuration and NSSA once you've enabled OSPF on an interface through **Routing → OSPF → Interface Configuration**. At least one router must have OSPF enabled for this web page to display.

To display the page, click **Routing → OSPF → Area Configuration** in the tree view. If a Stub Area has been created, the fields in the Stub Area Information are available. If a NSSA has been created, the fields in the NSSA Area Information are available.

Figure 9-7. OSPF Area Configuration

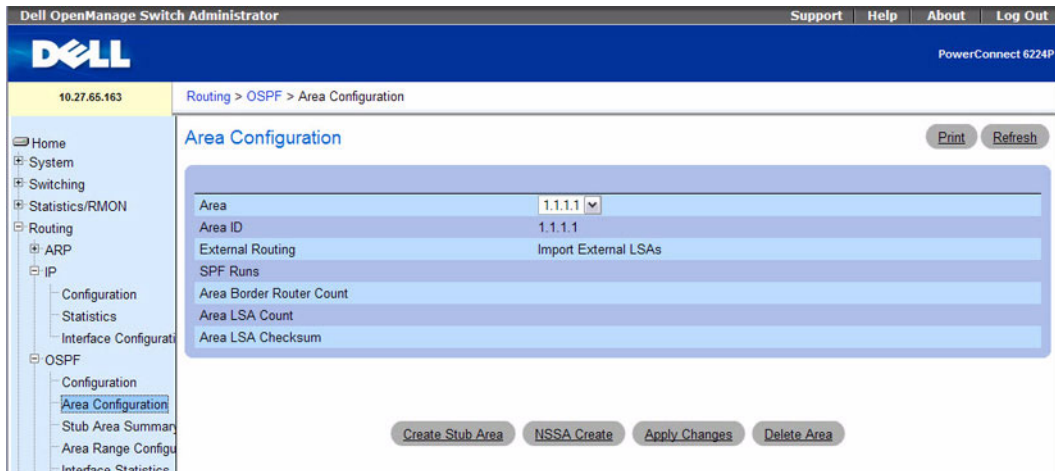

The **OSPF Area Configuration** page displays the following fields:

- **Area** — Select the area to be displayed from the drop-down menu. When an area is selected, fields in the Stub Area Information are displayed.
- **Area ID** — The OSPF area. An Area ID is a 32-bit integer in dotted decimal format that uniquely identifies the area to which a router interface connects.
- **External Routing** — A definition of the router's capabilities for the area, including whether or not AS-external-LSAs are flooded into/throughout the area. If the area is a stub area, then these are the possible options for which you may configure the external routing capability, otherwise the only option is Import External LSAs.
- **SPF Runs** — The number of times that the intra-area route table has been calculated using this area's link-state database. This is typically done using Dijkstra's algorithm.
- **Area Border Router Count** — The total number of area border routers reachable within this area. This is initially zero, and is calculated in each SPF Pass.
- **Area LSA Count** — The total number of link-state advertisements in this area's link-state database, excluding AS External LSAs.

- **Area LSA Checksum** — The 32-bit unsigned sum of the link-state advertisements' LS checksums contained in this area's link-state database. This sum excludes external (LS type 5) link-state advertisements. The sum can be used to determine if there has been a change in a router's link state database, and to compare the link-state database of two routers. This value is in hexadecimal.

Stub Area Information:

- **Import Summary LSAs** — Select Enable or Disable from the drop-down menu. If you select Enable summary LSAs is imported into stub areas.
- **Type of Service** — Specifies the parameters for the type of service requested. The parameters may be utilized by networks to define the handling of the datagram during transport. The type of service is associated with the stub metric. The switch supports Normal only.
- **Metric Value** — Enter the metric value you want applied for the default route advertised into the stub area. Valid values range from 1 to 16,777,215.

NSSA Area Information:

- **Import Summary LSAs** — Select Enable or Disable from the drop-down menu. If you select Enable summary LSAs is imported into stub areas.
- **Originate Default Route** — Enable or disable this field to set the default information origination configuration for the specified NSSA.
- **Metric Value** — Set the Metric value for NSSA. The valid range of values is (1 to 16777214).
- **Metric Type** — Select the type of metric specified in the Metric Value field, which can be one of the following:
 - **Default** — The default metric value.
 - **Comparable Cost** — External Type 1 metrics that are comparable to the OSPF metric.
 - **Non-comparable Cost** — External Type 2 metrics that are assumed be larger than the cost of the OSPF metric.
- **Translator Role** — Configure the NSSA Translator Role as always/candidate.
- **Translator Stability Interval** — Configure the Translator Stability Interval for the selected NSSA.
- **No-Redistribute Mode** — Configure the route redistribution for the selected NSSA.
- **Translator State** — Displays the current state of the Translator.

Configuring an OSPF Area

1. Open the **OSPF Area Configuration** page.
2. Specify an area to configure.
3. Specify values in the remaining fields as needed.
4. Click **Apply Changes**.

The OSPF area is defined and configured.

Displaying an OSPF Area Configuration

1. Open the **OSPF Area Configuration** page.
2. Select the OSPF area to display from the drop-down menu.

The OSPF area configuration is displayed for this area.

Deleting an OSPF Area Configuration

Use these steps to delete NSSA configuration or Stub area configuration.

1. Open the **OSPF Area Configuration** page.
2. Select the OSPF area configuration to delete from the drop-down menu.

The configuration displays.

3. Click **Delete**.

The OSPF area configuration is removed.

Configuring OSPF Area CLI Commands

For information about the CLI commands that perform this function, see the following chapter in the *CLI Reference Guide*:

- OSPF Commands

The following table summarizes the equivalent CLI commands for this feature.

Table 9-7. OSPF Area Configuration Commands

CLI Command	Description
area default-cost	Configures the monetary default cost for the stub area.
area nssa	Configures the specified area ID to function as an NSSA.
area nssa default-info-originate	Configures the metric value and type for the default route advertised into the NSSA.
area nssa no-redistribute	Configures the NSSA Area Border router (ABR) so that learned external routes are not redistributed to the NSSA.
area nssa no-summary	Configures the NSSA so that summary LSAs are not advertised into the NSSA.
area nssa translator-role	Configures the translator role of the NSSA.
area nssa translator-stab-intv	Configures the translator stability interval of the NSSA.
area stub	Creates a stub area for the specified area ID.
area stub no-summary	Prevents Summary LSAs from being advertised into the NSSA.
show ip ospf area	Displays information about the identified OSPF area.
show ip ospf range	Displays information about the area ranges for the specified area-id.

Stub Area Summary

The OSPF Stub Area Summary page displays OSPF stub area detail.

To display the page, click **Routing** → **OSPF** → **Stub Area Summary** in the tree view.

Figure 9-8. OSPF Stub Area Summary

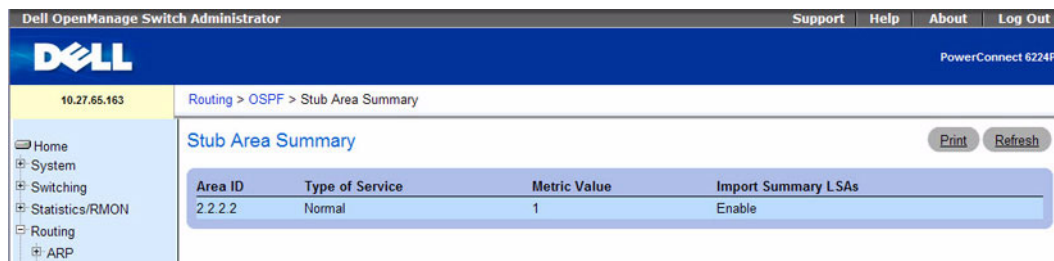

The OSPF Stub Area Summary page displays the following fields:

- **Area ID** — The Area ID of the stub area.
- **Type of Service** — The type of service associated with the stub metric. The switch supports **Normal** only.
- **Metric Value** — The metric value for the default route advertised into the area.
- **Import Summary LSAs** — Whether the import of Summary LASs is enabled or disabled.

Displaying OSPF Stub Area CLI Command

For information about the CLI command that performs this function, see the following chapter in the *CLI Reference Guide*:

- OSPF Commands

The following table summarizes the equivalent CLI commands for this feature.

Table 9-8. OSPF Area Configuration Commands

CLI Command	Description
show ip ospf stub table	Displays the OSPF stub table.

Area Range Configuration

Use the OSPF Area Range Configuration page to configure and display an area range for a specified NSSA.

To display the page, click **Routing** → **OSPF** → **Area Range Configuration** in the tree view.

Figure 9-9. OSPF Area Range Configuration

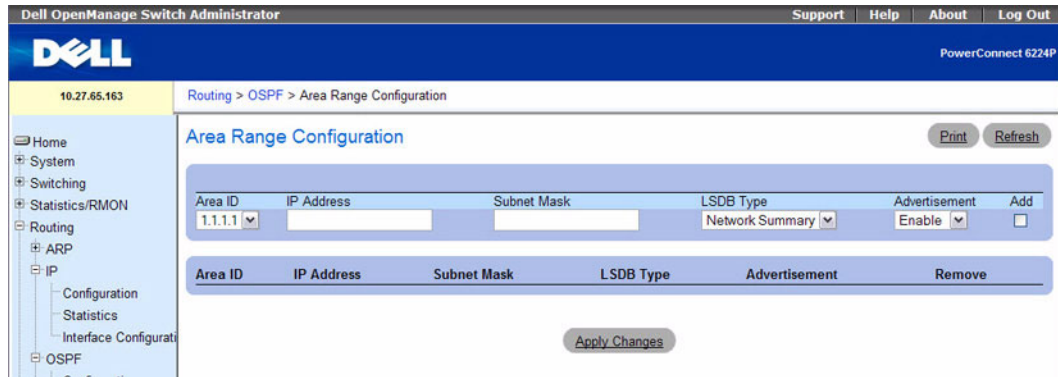

The OSPF Area Range Configuration page contains the following fields:

- **Area ID** — Select the area for which data is to be configured from the drop-down menu.
- **IP Address** — Enter the IP Address for the address range for the selected area.
- **Subnet Mask** — Enter the Subnet Mask for the address range for the selected area.
- **LSDB Type** — Select the type of Link Advertisement associated with the specified area and address range. The default type is 'Network Summary.'
- **Advertisement** — Select Enable or Disable from the drop-down menu. If you selected Enable the address range is advertised outside the area through a Network Summary LSA. The default is Enable.
- **Add** — Check the Add check box if you wish to add an area range.

OSPF Area Range Table

- **Area ID** — Displays the OSPF area.
- **IP Address** — Displays the IP address of an address range for the area.
- **Subnet Mask** — Displays the subnet mask of an address range for the area.
- **LSDB Type** — Displays the link advertisement type for the address range and area.
- **Advertisement** — Displays the advertisement mode for the address range and area.
- **Remove** — Removes the specified area entry.

Defining an OSPF Area Range

1. Open the **OSPF Area Range Configuration** page.
2. Enter Area ID, IP Address, Subnet Mask, LSDB Type and Advertisement.
3. Click the **Add** check box.
4. Click **Apply Changes**.

The OSPF area range is defined and configured. All configured OSPF area ranges are displayed in the table on the **OSPF Area Range Configuration** page.

Removing an OSPF Area Range Configuration

1. Open the **OSPF Area Range Configuration** page.
2. Select the **Remove** check box in the row of the **Area ID** to be deleted.
3. Click **Apply Changes**.

The address range is removed from the area configuration.

OSPF Area Range Configuration CLI Command

For information about the CLI commands that perform this function, see the following chapter in the *CLI Reference Guide*:

- OSPF Commands

The following table summarizes the equivalent CLI commands for this feature.

Table 9-9. OSPF Area Range Configuration Commands

CLI Command	Description
area range	Creates a specified area range for a specified NSSA.

Interface Statistics

Use the OSPF Interface Statistics page to display statistics for the selected interface. The information is displayed only if OSPF is enabled.

To display the page, click **Routing** → **OSPF** → **Interface Statistics** in the tree view.

Figure 9-10. OSPF Interface Statistics



The screenshot shows the Dell OpenManage Switch Administrator interface. The breadcrumb navigation is **Routing > OSPF > Interface Statistics**. The left sidebar shows a tree view with **OSPF > Interface Statistics** selected. The main content area displays the **Interface Statistics** page for the selected interface **vlan111**. The page includes a **Print** and **Refresh** button. The statistics table is as follows:

Field	Value
Interface	vlan111
OSPF Area ID	2.2.2.2
Area Border Router Count	0
AS Border Router Count	0
Area LSA Count	1
IP Address	9.25.67.1
Interface Events	6
Virtual Events	0
Neighbor Events	0
External LSA Count	0
Sent Packets	15
Received Packets	0
Discards	0
Bad Version	0
Source Not On Local Subnet	0
Virtual Link Not Found	0
Area Mismatch	0
Invalid Destination Address	0
Wrong Authentication Type	0
Authentication Failure	0
No Neighbor at Source Address	0
Invalid OSPF Packet Type	0
Hellos Ignored	0
Hellos Sent	15
Hellos Received	0
DD Packets Sent	0
DD Packets Received	0
LS Requests Sent	0
LS Requests Received	0
LS Updates Sent	0
LS Updates Received	0
LS Acknowledgements Sent	0
LS Acknowledgements Received	0

The OSPF Interface Statistics page contains the following fields:

- **Interface** — Select the interface for which data is to be displayed from the drop-down menu.

- **OSPF Area ID** — The OSPF area to which the selected router interface belongs. An OSPF Area ID is a 32-bit integer in dotted decimal format that uniquely identifies the area to which the interface connects.
- **Area Border Router Count** — The total number of area border routers reachable within this area. This is initially zero, and is calculated in each SPF Pass.
- **AS Border Router Count** — The total number of Autonomous System border routers reachable within this area. This is initially zero, and is calculated in each SPF Pass.
- **IP Address** — The IP address of the interface.
- **Interface Events** — The number of times the specified OSPF interface has changed its state, or an error has occurred.
- **Virtual Events** — The number of state changes or errors that have occurred on this virtual link.
- **Neighbor Events** — The number of times this neighbor relationship has changed state, or an error has occurred.
- **External LSA Count** — The number of external (LS type 5) link-state advertisements in the link-state database.
- **Sent Packets** — The number of OSPF packets transmitted on the interface.
- **Received Packets** — The number of valid OSPF packets received on the interface.
- **Discards** — The number of received OSPF packets discarded because of an error in the packet or an error in processing the packet.
- **Bad Version** — The number of received OSPF packets whose version field in the OSPF header does not match the version of the OSPF process handling the packet.
- **Source Not On Local Subnet** — The number of received packets discarded because the source IP address is not within a subnet configured on a local interface.
- **Virtual Link Not Found** — The number of received OSPF packets discarded where the ingress interface is in a non-backbone area and the OSPF header identifies the packet as belonging to the backbone, but OSPF does not have a virtual link to the packet's sender.
- **Area Mismatch** — The number of OSPF packets discarded because the area ID in the OSPF header is not the area ID configured on the ingress interface.
- **Invalid Destination Address** — The number of OSPF packets discarded because the packet's destination IP address is not the address of the ingress interface and is not the AllDrRouters or AllSpfRouters multicast addresses.
- **Wrong Authentication Type** — The number of packets discarded because the authentication type specified in the OSPF header does not match the authentication type configured on the ingress interface.
- **Authentication Failure** — The number of OSPF packets dropped because the sender is not an existing neighbor or the sender's IP address does not match the previously recorded IP address for that neighbor.

- **No Neighbor at Source Address** — The number of OSPF packets dropped because the sender is not an existing neighbor or the sender's IP address does not match the previously recorded IP address for that neighbor.
- **Invalid OSPF Packet Type** — The number of OSPF packets discarded because the packet type field in the OSPF header is not a known type.
- **Hellos Ignored** — The number of received Hello packets that were ignored by this router from the new neighbors after the limit has been reached for the number of neighbors on an interface or on the system as a whole.
- **Hellos Sent** — The number of Hello packets sent on this interface by this router.
- **Hellos Received** — The number of Hello packets received on this interface by this router.
- **DD Packets Sent** — The number of Database Description packets sent on this interface by this router.
- **DD Packets Received** — The number of Database Description packets received on this interface by this router.
- **LS Requests Sent** — The number of LS Requests sent on this interface by this router.
- **LS Requests Received** — The number of LS Requests received on this interface by this router.
- **LS Updates Sent** — The number of LS updates sent on this interface by this router.
- **LS Updates Received** — The number of LS updates received on this interface by this router.
- **LS Acknowledgements Sent** — The number of LS acknowledgements sent on this interface by this router.
- **LS Acknowledgements Received** — The number of LS acknowledgements received on this interface by this router.

Displaying OSPF Interface Statistics

1. Open the **OSPF Interface Statistics** page.
2. Select the interface for which data is to be displayed from the drop-down menu.
Statistics for this interface display.

Displaying OSPF Interface Statistics Using CLI Commands

For information about the CLI command that performs this function, see the following chapter in the *CLI Reference Guide*:

- OSPF Commands

The following table summarizes the equivalent CLI commands for this feature.

Table 9-10. OSFP Interface Statistics Command

CLI Command	Description
show ip ospf interface stats	Displays the statistics for a specific interface.

Interface Configuration

Use the OSPF Interface Configuration page to configure an OSPF interface.

To display the page, click **Routing** → **OSPF** → **Interface Configuration** in the tree view.

Figure 9-11. OSPF Interface Configuration

The screenshot shows the Dell OpenManage Switch Administrator interface. The top navigation bar includes 'Support', 'Help', 'About', and 'Log Out'. The main header displays the Dell logo and the device name 'PowerConnect 6224P'. The breadcrumb trail is 'Routing > OSPF > Interface Configuration'. The left sidebar shows a tree view with 'Routing' expanded to 'OSPF' and 'Interface Configuration' selected. The main content area is titled 'Interface Configuration' and contains a table of configuration fields. The fields are as follows:

Field	Value
Interface	vlan111
IP Address	9.25.67.1
Subnet Mask	255.255.255.0
OSPF Admin Mode	Enable
OSPF Area ID	2.2.2.2
Advertise Secondaries	Enable
Router Priority	1 (0 to 255)
Retransmit Interval	5 (0 to 3600 seconds)
Hello Interval	10 (1 to 65535 seconds)
Dead Interval	40 (1 to 65535 seconds)
LSA Ack Interval	1 (seconds)
Interface Delay Interval	1 (1 to 3600 seconds)
MTU Ignore	Disable
Passive Mode	Disable
Network Type	Broadcast
Authentication Type	None
State	Designated Router
Designated Router	1.1.1.1
Backup Designated Router	0.0.0.0
Number of Link Events	6
Local Link LSAs	0
Local Link LSA Checksum	0
Metric Cost	10 (1 to 65535)

Buttons for 'Print', 'Refresh', 'Apply Changes', and 'Modify' are visible on the page.

The OSPF Interface Configuration page contains the following fields:

- **Interface** — Select the interface for which data is to be displayed or configured from the drop-down menu.
- **IP Address** — Displays the address of the VLAN Interface.
- **Subnet Mask** — Displays the subnet mask of the VLAN Interface.
- **OSPF Admin Mode** — You may select **Enable** or **Disable** from the drop-down menu. The default value is **Disable**. You can configure OSPF parameters without enabling OSPF Admin Mode, but they have no effect until Admin Mode is enabled. The following information is displayed only if the Admin Mode is enabled: **State**, **Designated Router**, **Backup Designated Router**, **Number of Link Events**, **LSA Ack Interval**, and **Metric Cost**. For OSPF to be fully functional, you must enter a valid IP Address and Subnet Mask through the IP Interface Configuration page.



NOTE: Once OSPF is initialized on the router, it remains initialized until the router is reset.

- **OSPF Area ID** — Enter the 32-bit integer in dotted decimal format that uniquely identifies the OSPF area to which the selected router interface connects. If you assign an Area ID which does not exist, the area is created with default values.
- **Advertise Secondaries** — Select **Enable** or **Disable** from the drop-down menu to indicate the advertiseability of all secondary addresses. By default all the secondary addresses would be advertised on an interface enabled for OSPF.
- **Router Priority** — Enter the OSPF priority for the selected interface. The priority of an interface is specified as an integer from 0 to 255. The default is 1, which is the highest router priority. A value of 0 indicates that the router is not eligible to become the designated router on this network.
- **Retransmit Interval** — Enter the OSPF retransmit interval for the specified interface. This is the number of seconds between link-state advertisements for adjacencies belonging to this router interface. This value is also used when retransmitting database descriptions and link-state request packets. Valid values range from 0 to 3600 seconds (1 hour). The default is 5 seconds.
- **Hello Interval** — Enter the OSPF hello interval for the specified interface in seconds. This parameter must be the same for all routers attached to a network. Valid values range from 1 to 65,535. The default is 10 seconds.
- **Dead Interval** — Enter the OSPF dead interval for the specified interface in seconds. This specifies how long a router waits to see a neighbor router's Hello packets before declaring that the router is down. This parameter must be the same for all routers attached to a network. This value should be a multiple of the Hello Interval (for example 4). Valid values range from 1 to 65535. The default is 40.
- **LSA Ack Interval** — The number of seconds between LSA Acknowledgment packet transmissions, which must be less than the Retransmit Interval.
- **Interface Delay Interval** — Enter the OSPF Transit Delay for the specified interface. This specifies the estimated number of seconds it takes to transmit a link state update packet over the selected interface. Valid values range from 1 to 3600 seconds (1 hour). The default value is 1 second.
- **MTU Ignore** — Disables OSPF MTU mismatch detection on receiving packets. The default value is Disable.
- **Passive Mode** — Enable this mode to make the interface passive to prevent OSPF from forming an adjacency on an interface. OSPF advertises networks attached to passive interfaces as stub networks. Interfaces are not passive by default. It is common to configure an OSPF interface to be passive when OSPF must advertise the subnets configured on the interface, but routers on the subnet belong to other OSPF domains, such as an OSPFv3 router at the end of a 6to4 tunnel.
- **Network Type** — Sets the OSPF network type on the interface to broadcast or point-to-point.
 - **Broadcast** — OSPF only selects a designated router and originates network LSAs for broadcast networks. The default network type for Ethernet interfaces is broadcast.

- **Point-to-Point** — When there are only two routers on the network, OSPF can operate more efficiently by treating the network as a point-to-point network. For point-to-point networks, OSPF does not elect a designated router or generate a network link state advertisement (LSA). Both endpoints of the link must be configured to operate in point-to-point mode.
- **Authentication Type** — You may select an authentication type other than **None** by clicking on the **Modify** button. You then see a new web page, where you can select the authentication type from the drop-down menu. Possible values are:
 - **None** — This is the initial interface state. If you select this option from the drop-down menu on the second screen and click **Apply Changes**, you are returned to the first screen, and no authentication protocols are run.
 - **Simple** — If you select **Simple**, you are prompted to enter an authentication key. This key is included, in the clear, in the OSPF header of all packets sent on the network. All routers on the network must be configured with the same key.
 - **Encrypt** — If you select **Encrypt**, you are prompted to enter both an authentication key and an authentication ID. Encryption uses the MD5 Message-Digest algorithm. All routers on the network must be configured with the same key and ID.
- **AuthKey** — Enter the OSPF Authentication Key for the specified interface. If you do not choose to use authentication you will not be prompted to enter a key. If you choose 'simple' authentication you cannot use a key of more than 8 octets. If you choose 'encrypt' the key may be up to 16 octets long. The key value will only be displayed if you are logged on with Read/Write privileges, otherwise it will be displayed as asterisks.
- **AuthKeyID** — Enter the ID to be used for authentication. You will only be prompted to enter an ID when you select **Encrypt** as the authentication type. The ID is a number between 0 and 255, inclusive.
- **State** — If the OSPF admin mode is enabled, this field shows the current state of the selected router interface. If the OSPF admin mode is disabled, this field is blank. Possible values are:
 - **Down** — This is the initial interface state. In this state, the lower-level protocols have indicated that the interface is unusable. In this state, interface parameters are set to their initial values. All interface timers are disabled, and there are no adjacencies associated with the interface.
 - **Loopback** — In this state, the router's interface to the network is looped back either in hardware or software. The interface is unavailable for regular data traffic. However, it may still be desirable to gain information on the quality of this interface, either through sending ICMP pings to the interface or through something like a bit error test. For this reason, IP packets may still be addressed to an interface in Loopback state. To facilitate this, such interfaces are advertised in router- LSAs as single host routes, whose destination is the IP interface address.
 - **Waiting** — The router is trying to determine the identity of the (Backup) Designated Router for the network by monitoring received Hello Packets. The router is not allowed to elect a Backup Designated Router or a Designated Router until it transitions out of Waiting state. This prevents unnecessary changes of (Backup) Designated Router.

- **Designated Router** — This router is itself the Designated Router on the attached network. Adjacencies are established to all other routers attached to the network. The router must also originate a network-LSA for the network node. The network-LSA contains links to all routers (including the Designated Router itself) attached to the network.
- **Backup Designated Router** — This router is the Backup Designated Router on the attached network. It is promoted to Designated Router if the present Designated Router fails. The router establishes adjacencies to all other routers attached to the network. The Backup Designated Router performs slightly different functions during the Flooding Procedure, as compared to the Designated Router.
- **Other Designated Router** — The interface is connected to a broadcast or NBMA network on which other routers have been selected to be the Designated Router and Backup Designated Router either. The router attempts to form adjacencies to both the Designated Router and the Backup Designated Router.
- **Designated Router** — The identity of the Designated Router for this network, in the view of the advertising router. The Designated Router is identified here by its router ID. The value 0.0.0.0 means that there is no Designated Router. This field is only displayed if the OSPF admin mode is enabled.
- **Backup Designated Router** — The identity of the Backup Designated Router for this network, in the view of the advertising router. The Backup Designated Router is identified here by its router ID. Set to 0.0.0.0 if there is no Backup Designated Router. This field is only displayed if the OSPF admin mode is enabled.
- **Number of Link Events** — This is the number of times the specified OSPF interface has changed its state. This field is only displayed if the OSPF admin mode is enabled.
- **Local Link LSAs** — The number of opaque LSAs whose flooding scope is the link on this interface.
- **Local Link LSA Checksum** — The sum of the checksums of local link LSAs for this link.
- **Metric Cost** — Enter the value on this interface for the cost TOS (type of service). The range for the metric cost is between 1 and 65,535. Metric Cost is only configurable/displayed if OSPF is initialized on the interface.

Configuring an OSPF Interface

1. Open the **OSPF Interface Configuration** page.
2. Specify an interface to configure.
3. Specify values in the remaining fields as needed.
4. Click **Apply Changes**.

The OSPF interface is configured.

Displaying an OSPF Interface Configuration

1. Open the **OSPF Interface Configuration** page.
2. Select the VLAN interface for which data is to be displayed from the drop-down menu.

Configuration data for this interface display.

Configuring an OSPF Interface using CLI Commands

For information about the CLI commands that perform this function, see the following chapter in the *CLI Reference Guide*:

- OSPF Commands

The following table summarizes the equivalent CLI commands for this feature.

Table 9-11. OSPF Interface Configuration Commands

CLI Command	Description
ip ospf area	Enables OSPFv2 and sets the area ID of an interface.
ip ospf authentication	Sets the OSPF Authentication Type and Key for the specified interface.
ip ospf cost	Configures the cost on an OSPF interface.
ip ospf dead-interval	Sets the OSPF dead interval for the specified interface.
ip ospf hello-interval	Sets the OSPF hello interval for the specified interface.
ip ospf network	Configure OSPF to treat an interface as a point-to-point rather than broadcast interface.
ip ospf priority	Sets the OSPF priority for the specified router interface.
ip ospf retransmit-interval	Sets the OSPF retransmit Interval for the specified interface.
ip ospf transmit-delay	Sets the OSPF Transit Delay for the specified interface.
network area	Enables OSPFv2 on an interface and sets its area ID if the IP address of an interface is covered by this network command.
passive-interface	Sets the interface or tunnel as passive.
show ip ospf interface	Displays the information for the IFO object or virtual interface tables.
show ip ospf interface brief	Displays brief information for the IFO object or virtual interface tables.

Neighbor Table

Use the **OSPF Neighbor Table** page to display the OSPF neighbor table list. When a particular neighbor ID is specified, detailed information about a neighbor is given. The information below is only displayed if OSPF is enabled.

To display the page, click **Routing** → **OSPF** → **Neighbor Table** in the tree view.

Figure 9-12. OSPF Neighbor Table

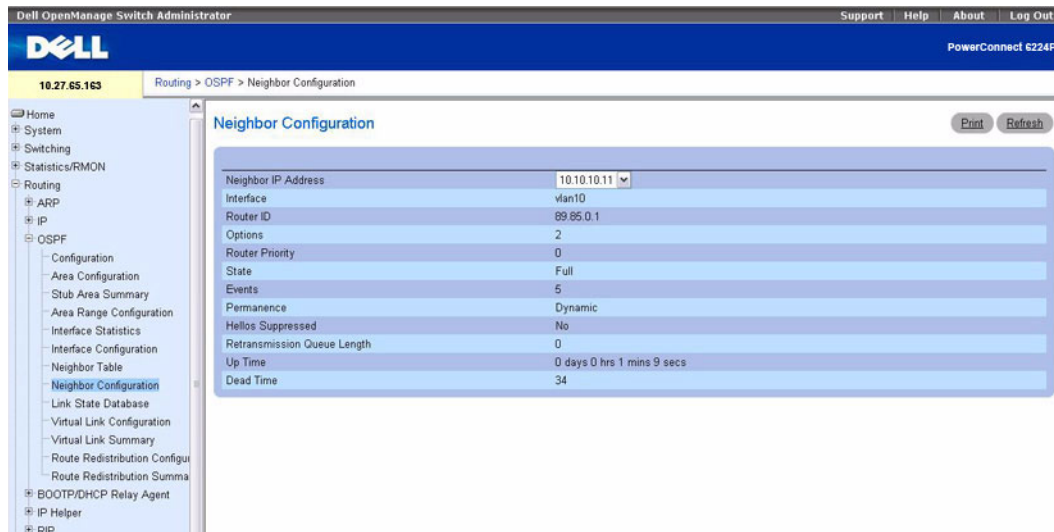

The OSPF Neighbor Table page displays the following fields:

- **Interface** — Select the interface for which data is to be displayed from a drop-down menu.
- **Router ID** — A 32-bit integer in dotted decimal format representing the neighbor interface.
- **IP Address** — The IP address of the neighboring router's interface to the attached network. It is used as the destination IP address when protocol packets are sent as unicasts along this adjacency. Also used in router-LSAs as the Link ID for the attached network if the neighboring router is selected to be designated router. The Neighbor IP address is learned when Hello packets are received from the neighbor. For virtual links, the Neighbor IP address is learned during the routing table build process.
- **Neighbor Interface Index** — An interface identifying the neighbor interface index.

Displaying the OSPF Neighbor Table Using CLI Commands

For information about the CLI command that performs this function, see the following chapter in the *CLI Reference Guide*:

- OSPF Commands

The following table summarizes the equivalent CLI commands for this feature.

Table 9-12. OSPF Neighbor Table Commands

CLI Command	Description
show ip ospf neighbor	Displays information about OSPF neighbors.

Neighbor Configuration

Use the **OSPF Neighbor Configuration** page to display the OSPF neighbor configuration for a selected neighbor ID. When a particular neighbor ID is specified, detailed information about a neighbor is given. The information below is only displayed if OSPF is enabled and the interface has a neighbor. The IP address is the IP address of the neighbor.

To display the page, click **Routing** → **OSPF** → **Neighbor Configuration** in the tree view.

Figure 9-13. OSPF Neighbor Configuration

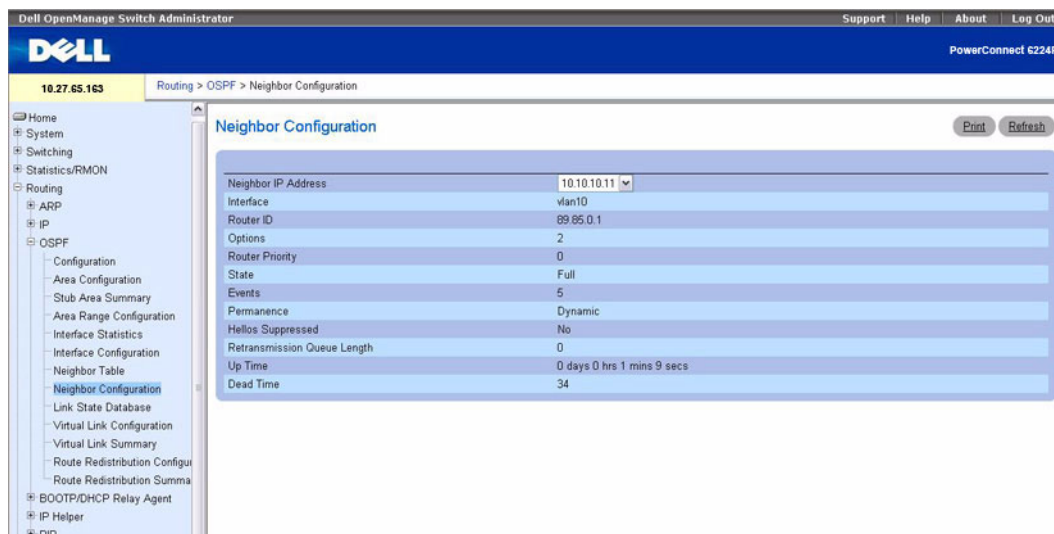

The OSPF Neighbor Configuration page contains the following fields:

- **Interface** — Select the VLAN interface on which routing is enabled from the drop-down menu.
- **Neighbor IP Address** — Select the IP Address of the neighbor for which data is to be displayed.
- **Router ID** — A 32-bit integer in dotted decimal format that identifies the neighbor router.
- **Options** — The optional OSPF capabilities supported by the neighbor. The OSPF Options field is present in OSPF Hello packets, Database Description packets, and all link-state advertisements. The Options field enables OSPF routers to support (or not support) optional capabilities, and to

communicate their capability level to other OSPF routers. Through this mechanism, routers of differing capabilities can be mixed within an OSPF routing domain. The Options value is a bitmap, and it signifies the capability of the neighbor.

- **Router Priority** — Displays the OSPF priority for the specified neighbor. The priority of a neighbor is a priority integer from 0 to 255. A value of 0 indicates that the router is not eligible to become the designated router on this network.
- **State** — The state of a neighbor can be the following:
 - **Down** — This is the initial state of a neighbor conversation. It indicates that there has been no recent information received from the neighbor. On NBMA networks, Hello packets may still be sent to Down neighbors, although at a reduced frequency.
 - **Attempt** — This state is only valid for neighbors attached to NBMA networks. It indicates that no recent information has been received from the neighbor, but that an effort should be made to contact the neighbor (sending the neighbor Hello packets at intervals of Hello Interval).
 - **Init** — In this state, a Hello packet has recently been seen from the neighbor. However, bidirectional communication has not yet been established with the neighbor (i.e., the router itself did not appear in the neighbor's Hello packet). All neighbors in this state (or greater) are listed in the Hello packets sent from the associated interface.
 - **2-Way** — In this state, communication between the two routers is bidirectional. This has been assured by the operation of the Hello Protocol. This is the most advanced state short of beginning adjacency establishment. The (Backup) Designated Router is selected from the set of neighbors in state 2-Way or greater.
 - **Exchange Start** — This is the first step in creating an adjacency between the two neighboring routers. The goal of this step is to decide which router is the master, and to decide upon the initial DD sequence number. Neighbor conversations in this state or greater are called adjacencies.
 - **Exchange** — In this state, the router is describing its entire link state database by sending Database Description packets to the neighbor. In this state, Link State Request Packets may also be sent asking for the neighbor's more recent LSAs. All adjacencies in Exchange state or greater are used by the flooding procedure. These adjacencies are fully capable of transmitting and receiving all types of OSPF routing protocol packets.
 - **Loading** — In this state, Link State Request packets are sent to the neighbor asking for the more recent LSAs that have been discovered (but not yet received) in the Exchange state.
 - **Full** — In this state, the neighboring routers are fully adjacent. These adjacencies appear in router-LSAs and network-LSAs.
- **Events** — The number of times this neighbor relationship has changed state, or an error has occurred.
- **Permanence** — This variable displays the status of the entry. Dynamic and permanent see how the neighbor became known.
- **Hellos Suppressed** — This indicates whether Hellos are being suppressed to the neighbor.
- **Retransmission Queue Length** — The current length of the retransmission queue.

Displaying OSPF Neighbor Configuration

1. Open the **OSPF Neighbor Configuration** page.
2. Select the interface and the IP address to display.

The neighbor configuration displays.

Displaying OSPF Neighbor Configuration Using CLI Commands

For information about the CLI command that performs this function, see the following chapter in the *CLI Reference Guide*:

- OSPF Commands

The following table summarizes the equivalent CLI commands for this feature.

Table 9-13. OSPF Neighbor Detail Command

CLI Command	Description
show ip ospf neighbor	Displays information about OSPF neighbors.

Link State Database

Use the OSPF Link State Database page to display OSPF link state, external LSDB table, and AS opaque LSDB table information.

To display the page, click **Routing** → **OSPF** → **Link State Database** in the tree view.

Figure 9-14. OSPF Link State Database

The screenshot shows the Dell OpenManage Switch Administrator interface. The main content area is titled "Link State Database" and contains a table with the following data:

Router ID	Area ID	LSA Type	LS ID	Age	Sequence	Checksum	Options
55.5.5.5	0.0.0.0	Router Links	55.5.5.5	91	0x80000013	0xF008	-E ---
89.85.0.1	0.0.0.0	Router Links	89.85.0.1	102	0x80000003	0x7E1A	-----
89.85.0.2	0.0.0.0	Router Links	89.85.0.2	102	0x80000003	0x7C19	-----
55.5.5.5	0.0.0.0	Network Links	10.10.10.10	91	0x80000003	0x3E00	-E -O -
89.85.0.1	0.0.0.0	Network Summary	192.168.1.0	102	0x80000002	0xF54E	-----
89.85.0.1	0.0.0.0	Network Summary	192.168.2.0	102	0x80000002	0xEA58	-----
89.85.0.1	0.0.0.0	Network Summary	192.168.3.0	102	0x80000002	0xDF62	-----
89.85.0.1	0.0.0.0	Network Summary	192.168.4.0	102	0x80000002	0xD46C	-----
89.85.0.1	0.0.0.0	Network Summary	192.168.5.0	102	0x80000002	0xC976	-----
89.85.0.2	0.0.0.0	Network Summary	192.169.1.0	102	0x80000002	0xE35E	-----
89.85.0.2	0.0.0.0	Network Summary	192.169.2.0	102	0x80000002	0xD668	-----
89.85.0.2	0.0.0.0	Network Summary	192.169.3.0	102	0x80000002	0xCD72	-----
89.85.0.2	0.0.0.0	Network Summary	192.169.4.0	102	0x80000002	0xC27C	-----
89.85.0.2	0.0.0.0	Network Summary	192.169.5.0	102	0x80000002	0xB786	-----

Below the main table are two sections:

External LSDB Table

Router ID	LSA Type	LS ID	Age	Sequence	Checksum
-----------	----------	-------	-----	----------	----------

AS Opaque LSDB Table

Router ID	LSA Type	LS ID	Age	Sequence	Checksum
-----------	----------	-------	-----	----------	----------

The OSPF Link State Database page displays the following fields:

- **Router ID** — The 32-bit integer in dotted decimal format that uniquely identifies the router within the autonomous system (AS). The Router ID is set on the IP Configuration page. If you want to change the Router ID you must first disable OSPF. After you set the new Router ID, you must re-enable OSPF to have the change take effect. The default value is 0.0.0.0, although this is not a valid Router ID.
- **Area ID** — The ID of an OSPF area to which one of the router interfaces is connected. An Area ID is a 32-bit integer in dotted decimal format that uniquely identifies the area to which an interface is connected.
- **LSA Type** — The format and function of the link state advertisement. Possible values are:
 - Router Links
 - Network Links

- Network Summary
- ASBR Summary
- AS-external
- **LS ID** — The Link State ID identifies the piece of the routing domain that is being described by the advertisement. The value of the LS ID depends on the advertisement's LS type.
- **Age** — The time since the link state advertisement was first originated, in seconds.
- **Sequence** — The sequence number field is a signed 32-bit integer. It is used to detect old and duplicate link state advertisements. The larger the sequence number, the more recent the advertisement.
- **Checksum** — The checksum is used to detect data corruption of an advertisement. This corruption can occur while an advertisement is being flooded, or while it is being held in a router's memory. This field is the checksum of the complete contents of the advertisement, except the LS age field.
- **Options** — The Options field in the link state advertisement header indicates which optional capabilities are associated with the advertisement. Possible values are:
 - **Q** — This enables support for QoS Traffic Engineering.
 - **E** — This describes the way AS-external-LSAs are flooded.
 - **MC** — This describes the way IP multicast datagrams are forwarded according to the standard specifications.
 - **O** — This describes whether Opaque-LSAs are supported.
 - **V** — This describes whether OSPF ++ extensions for VPN/COS are supported.

Displaying the OSPF Link State Database Using CLI Commands

For information about the CLI command that performs this function, see the following chapter in the *CLI Reference Guide*:

- OSPF Commands

The following table summarizes the equivalent CLI commands for this feature.

Table 9-14. OSPF Link State Database Commands

CLI Command	Description
show ip ospf database	Displays information about the link state database when OSPF is enabled.
show ip ospf database database-summary	Displays the number of each type of LSA in the database for each area and for the router.

Virtual Link Configuration

Use the **Virtual Link Configuration** page to create or configure virtual interface information for a specific area and neighbor. A valid OSPF area must be configured before this page can be displayed.

To display the page, click **Routing** → **OSPF** → **Virtual Link Configuration** in the tree view.

Figure 9-15. OSPF Virtual Link Configuration - Create

The screenshot shows the Dell OpenManage Switch Administrator interface. The breadcrumb navigation is **Routing > OSPF > Virtual Link Configuration**. The page title is **Virtual Link Configuration**. The configuration form contains the following fields:

Virtual Link Area ID	0.0.0.2	
Virtual Link Neighbor Router ID	10.10.23.3	
Hello Interval	10	(1 to 65535 seconds)
Dead Interval	40	(1 to 65535 seconds)
Transit Delay Interval	1	(0 to 3600 seconds)
State	Down	
Neighbor State	Down	
Retransmit Interval	5	(0 to 3600 seconds)
Authentication Type	None	

Buttons at the bottom of the form include **Configure Authentication**, **Delete**, and **Apply Changes**. The left sidebar shows the navigation tree with **OSPF** expanded to **Virtual Link Configuration**.

The OSPF Virtual Link Configuration pages contain the following fields:

- **Virtual Link (Area ID - Neighbor Router ID)** — Select the virtual link for which you want to display or configure data. It consists of the Area ID and Neighbor Router ID. To create a new virtual link, select **Create New Virtual Link** from the drop-down menu to define a new virtual link. When **Create New Virtual Link** is selected, the following fields appear:
 - **Area ID** — The 32-bit integer in dotted decimal format that uniquely identifies the area to which a router interface connects.
 - **Neighbor Router ID** — The 32-bit integer in dotted decimal format that uniquely identifies the neighbor router that is part of the virtual link.
- **Hello Interval** — Enter the OSPF hello interval for the specified interface in seconds. This parameter must be the same for all routers attached to a network. Valid values range from 1 to 65535. The default is 10 seconds.

- **Dead Interval** — Enter the OSPF dead interval for the specified interface in seconds. This specifies how long a router waits to see a neighbor router's Hello packets before declaring that the router is down. This parameter must be the same for all routers attached to a network. This value should be a multiple of the Hello Interval (for example, 4). Valid values range from 1 to 65535. The default is 40 seconds.
- **Interface Delay Interval (secs)** — The OSPF Transit Delay for the virtual link in units of seconds. It specifies the estimated number of seconds it takes to transmit a link state update packet over this interface.
- **State** — The current state of the selected Virtual Link. One of:
 - **Down** — This is the initial interface state. In this state, the lower-level protocols have indicated that the interface is unusable. In this state, interface parameters are set to their initial values. All interface timers are disabled, and there are no adjacencies associated with the interface.
 - **Waiting** — The router is trying to determine the identity of the (Backup) Designated Router by monitoring received Hello Packets. The router is not allowed to elect a Backup Designated Router or a Designated Router until it transitions out of Waiting state. This prevents unnecessary changes of (Backup) Designated Router.
 - **Point-to-Point** — The interface is operational, and is connected either to the virtual link. On entering this state the router attempts to form an adjacency with the neighboring router. Hello Packets are sent to the neighbor every HelloInterval seconds.
 - **Designated Router** — This router is itself the Designated Router on the attached network. Adjacencies are established to all other routers attached to the network. The router must also originate a network-LSA for the network node. The network- LSA contains links to all routers (including the Designated Router itself) attached to the network.
 - **Backup Designated Router** — This router is itself the Backup Designated Router on the attached network. It is promoted to Designated Router if the present Designated Router fails. The router establishes adjacencies to all other routers attached to the network. The Backup Designated Router performs slightly different functions during the Flooding Procedure, as compared to the Designated Router.
 - **Other Designated Router** — The interface is connected to a broadcast or NBMA network on which other routers have been selected to be the Designated Router and Backup Designated Router either. The router attempts to form adjacencies to both the Designated Router and the Backup Designated Router.
- **Neighbor State** — The state of the Virtual Neighbor Relationship.
- **Retransmit Interval** — Enter the OSPF retransmit interval for the specified interface. This is the number of seconds between link-state advertisements for adjacencies belonging to this router interface. This value is also used when retransmitting database descriptions and link-state request packets. Valid values range from 0 to 3600 seconds (1 hour). The default is 5 seconds.
- **Authentication Type** — You may select an authentication type other than none by clicking on the **Configure Authentication** button. You then see a new screen, where you can select the authentication type from the drop-down menu. The choices are:

- **None** — This is the initial interface state. If you select this option from the drop-down menu on the second screen and click **Apply Changes**, you are returned to the first screen.
- **Simple** — If you select Simple you are prompted to enter an authentication key. This key is included, in the clear, in the OSPF header of all packets sent on the network. All routers on the network must be configured with the same key.
- **Encrypt** — If you select Encrypt you are prompted to enter both an authentication key and an authentication ID. Encryption uses the MD5 Message-Digest algorithm. All routers on the network must be configured with the same key and ID.
- **Authentication Key** — Enter the OSPF Authentication Key for the specified interface. If you do not choose to use authentication you are not prompted to enter a key. If you choose Simple authentication you cannot use a key of more than 8 characters. If you choose Encrypt the key may be up to 16 characters long. The key value is only displayed if you are logged on with Read/Write privileges, otherwise it is displayed as asterisks.
- **Authentication ID** — Enter the ID to be used for authentication. You are only prompted to enter an ID when you select Encrypt as the authentication type. The ID is a number between 0 and 255, inclusive.

Defining a New Virtual Link

1. Open the **OSPF Virtual Link Configuration** page.
2. Select **Create New Virtual Link** from the **Virtual Link (Area ID - Neighbor Router ID)** drop-down menu.
3. Specify the neighbor router ID for the new virtual link.
4. Click **Apply Changes**.

The remaining fields display when the Virtual Link is created.

Figure 9-16. OSPF Virtual Link Configuration

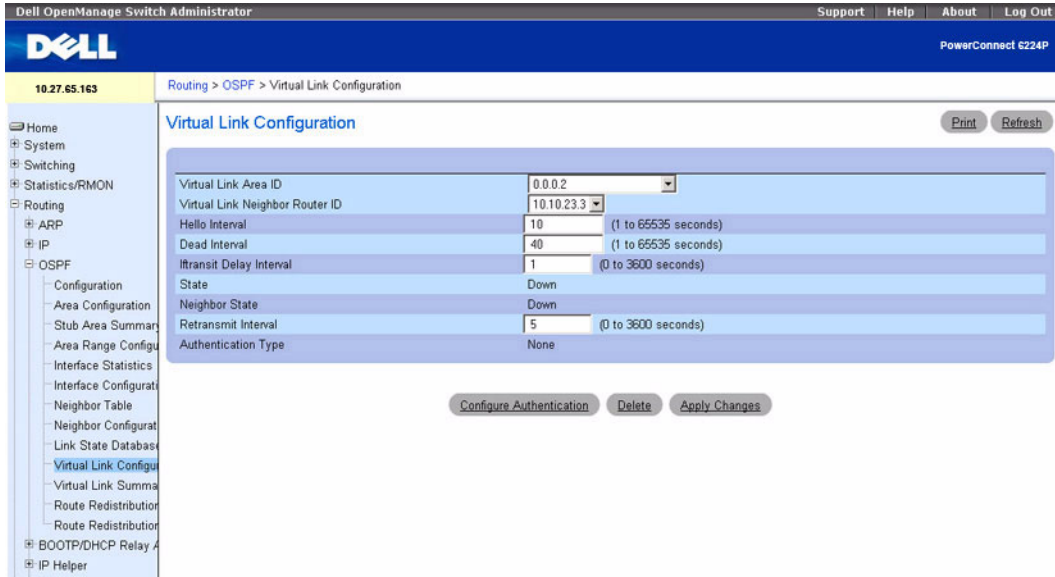

5. Click **Configure Authentication** to modify authentication.

The following page appears:

Figure 9-17. OSPF Virtual Link Authentication Configuration

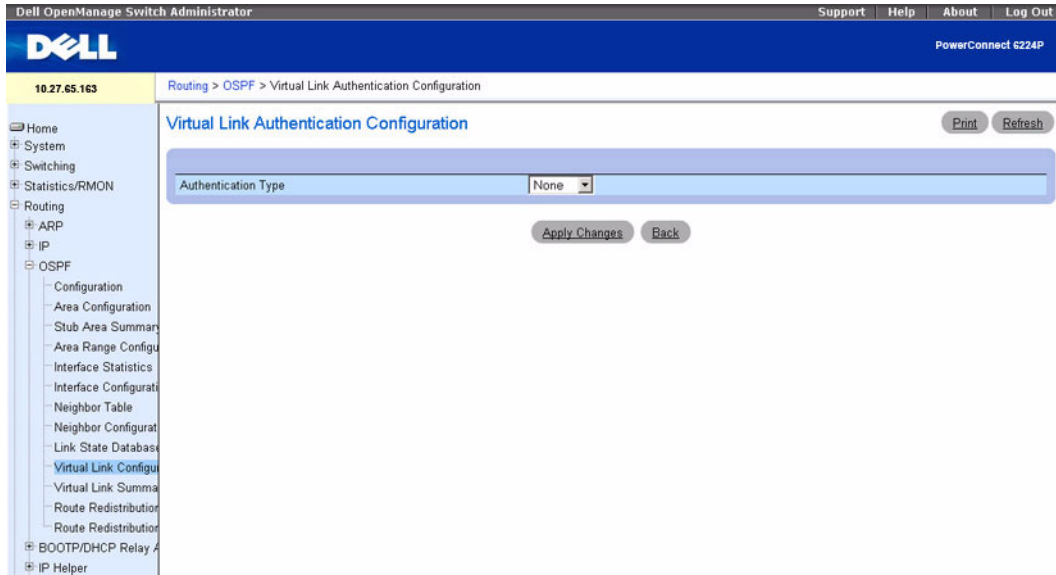

6. Select values for **Authentication Type** and **Authentication Key**.
7. Click **Apply Changes** when finished.

Configuring Virtual Link Data

1. Open the **OSPF Virtual Link Configuration** page.
2. Specify the area ID and neighbor router ID to configure.
3. Enter data into the fields as needed.
4. Click **Configure Authentication** to modify authentication.
5. Click **Apply Changes** when finished.
The virtual link data for the specified IDs is configured, and the device is updated.

Displaying Virtual Link Data

1. Open the **OSPF Virtual Link Configuration** page.
2. Specify the area ID and neighbor router ID to display.
The virtual link data for these IDs displays.

Removing a Virtual Link

1. Open the **OSPF Virtual Link Configuration** page.
2. Specify the Area ID and Neighbor Router ID associated with the virtual link to be removed.

The related virtual link data displays.

3. Click Delete.

The virtual link is removed, and the device is updated.

Configuring Virtual Link Data Using CLI Commands

For information about the CLI commands that perform this function, see the following chapter in the *CLI Reference Guide*:

- OSPF Commands

The following table summarizes the equivalent CLI commands for this feature.

Table 9-15. OSPF Virtual Link Commands

CLI Command	Description
area virtual-link	Creates the OSPF virtual interface for the specified area-id and neighbor router.
area virtual-link authentication	Configures the authentication type and key for the OSPF virtual interface identified by the area ID and neighbor ID.
area virtual-link dead-interval	Configures the dead interval for the OSPF virtual interface on the virtual interface identified by area-id and neighbor router.
area virtual-link hello-interval	Configures the hello interval for the OSPF virtual interface on the virtual interface identified by the area ID and neighbor ID.
area virtual-link retransmit-interval	Configures the retransmit interval for the OSPF virtual interface on the virtual interface identified by the area ID and neighbor ID.
area virtual-link transmit-delay	Configures the transmit delay for the OSPF virtual interface on the virtual interface identified by the area ID and neighbor ID.
show ip ospf virtual-link	Displays the OSPF Virtual Interface information for a specific area and neighbor.

Virtual Link Summary

Use the OSPF Virtual Link Summary page to display all of the configured virtual links.

To display the page, click **Routing** → **OSPF** → **Virtual Link Summary** in the tree view.

Figure 9-18. OSPF Virtual Link Summary

Area ID	Neighbor Router ID	Hello Interval(secs)	Dead Interval(secs)	Retransmit Interval(secs)	Transit Delay Interval (secs)
0.0.0.2	10.10.23.3	10	40	5	1

The OSPF Virtual Link Summary page contains the following fields:

- **Area ID** — The Area ID portion of the virtual link identification for which data is to be displayed. The Area ID and Neighbor Router ID together define a virtual link.
- **Neighbor Router ID** — The neighbor portion of the virtual link identification. Virtual links may be configured between any pair of area border routers with interfaces to a common (non-backbone) area.
- **Hello Interval (secs)** — The OSPF hello interval for the virtual link in units of seconds. The value for hello interval must be the same for all routers attached to a network.
- **Dead Interval (secs)** — The OSPF dead interval for the virtual link in units of seconds. This specifies how long a router waits to see a neighbor router's Hello packets before declaring that the router is down. This parameter must be the same for all routers attached to a common network, and should be a multiple of the Hello Interval (i.e. 4).
- **Retransmit Interval (secs)** — The OSPF retransmit interval for the virtual link in units of seconds. This specifies the time between link-state advertisements for adjacencies belonging to this router interface. This value is also used when retransmitting database descriptions and link-state request packets.

- **Iftransit Delay Interval (secs)** — The OSPF Transit Delay for the virtual link in units of seconds. It specifies the estimated number of seconds it takes to transmit a link state update packet over this interface.

Displaying the Virtual Link Summary Using CLI Commands

For information about the CLI command that performs this function, see the following chapter in the *CLI Reference Guide*:

- OSPF Commands

The following table summarizes the equivalent CLI commands for this feature.

Table 9-16. OSPF Virtual Link Summary Command

CLI Command	Description
show ip ospf virtual-link brief	Displays the OSPF Virtual Interface information for all areas in the system.

Route Redistribution Configuration

Use the **OSPF Route Redistribution Configuration** page to configure redistribution in OSPF for routes learned through various protocols. You can choose to redistribute routes learned from all available protocols or from selected ones.

To display the page, click **Routing** → **OSPF** → **Route Redistribution Configuration** in the tree view.

Figure 9-19. OSPF Route Redistribution Configuration

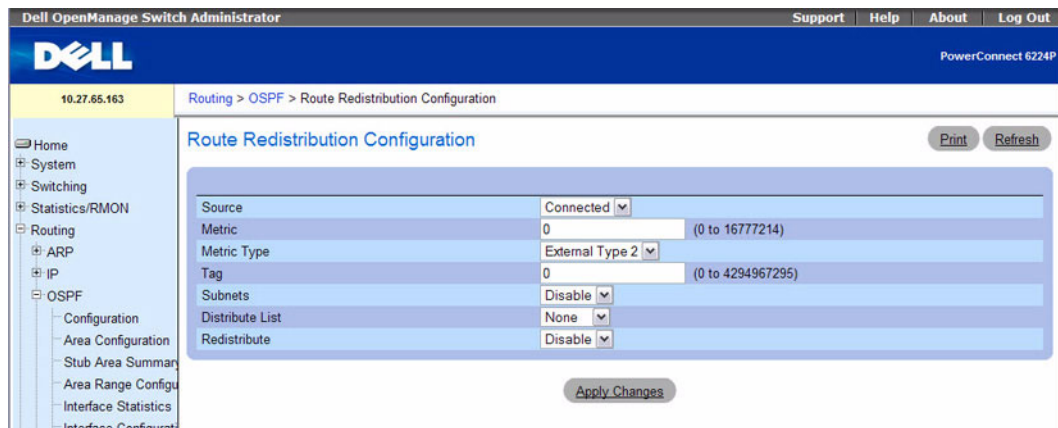

The OSPF Route Redistribution Configuration page contains the following fields:

- **Source** — A protocol configured for OSPF to redistribute the routes learned through this protocol. Only source routes that have been configured for redistribution by OSPF are available. Possible values are Static, Connected, and RIP.

- **Metric** — Sets the metric value for redistributed routes. This field displays a metric value if the source was preconfigured. The valid values are 0 to 16777214.
- **Metric Type** — Select the OSPF metric type of redistributed routes from the drop-down menu.
- **Tag** — Sets the tag field in routes redistributed. This field displays a tag value if the source was preconfigured, otherwise 0 is displayed. The valid values are 0 to 4294967295.
- **Subnets** — Select whether the subnetted routes should be redistributed or not from the drop-down menu.
- **Distribute List** — Selects the Access List that filters the routes to be redistributed by the destination protocol. Only permitted routes are redistributed. If this command refers to a non-existent access list, all routes are permitted. The drop-down menu lists the ACLs configured from the **Switching**→**Network Security**→**Access Control Lists**→**IP Access Control Lists** pages. When used for route filtering, the only fields in an access list that get used are:
 - Source IP Address and netmask
 - Destination IP Address and netmask
 - Action (permit or deny)

All other fields (source and destination port, precedence, tos, and so on.) are ignored.

The source IP address is compared to the destination IP address of the route. The source IP netmask in the access list rule is treated as a wildcard mask, indicating which bits in the source IP address must match the destination address of the route.

 **NOTE:** A 1 in the mask indicates a Don't Care in the corresponding address bit.

When an access list rule includes a destination IP address and netmask (an extended access list), the destination IP address is compared to the network mask of the route destination. The destination netmask in the access list serves as a wildcard mask, indicating which bits in the route's destination mask are significant for the filtering operation.

- **Redistribute** — Enables or disables the redistribution for the selected source protocol. This field has to be enabled in order to be able to configure any of the route redistribution attributes.

Creating an OSPF Route Redistribution Source

When no redistributions are configured, the system displays only Create in the Configured Source field and possible sources in the Available Source fields. When you select an Available Source, enter configuration data, and click **Apply Changes**, the item displays in the Configure Source drop-down list and is removed from the Available Source drop-down list.

1. Open the **OSPF Route Redistribution Configuration** page.
2. Specify **Create** in the Configured Source field.
3. Select Static, Connected, or RIP from the Available Source field.
4. Click **Apply Changes** when finished.

The route redistribution data is configured, and the device is updated.

Modifying OSPF Route Redistribution Data

1. Open the OSPF Route Redistribution Configuration page.
2. Select a source from the Configured Source drop-down.
3. Enter data in the fields as needed.
4. Click **Apply Changes** when finished.

The route redistribution data is configured, and the device is updated.

Configuring OSPF Route Redistribution Data using CLI Command

For information about the CLI command that performs this function, see the following chapter in the *CLI Reference Guide*:

- OSPF Commands

The following table summarizes the equivalent CLI commands for this feature.

Table 9-17. OSPF Route Redistribution Configuration Commands

CLI Command	Description
redistribute	Configures OSPF protocol to allow redistribution of routes from the specified source protocol/routers.
distribute-list out	Specifies the access list to filter routes received from the source protocol.

Route Redistribution Summary

Use the OSPF Route Redistribution Summary page to display OSPF Route Redistribution configurations.

To display the page, click **Routing** → **OSPF** → **Route Redistribution Summary** in the tree view.

Figure 9-20. OSPF Route Redistribution Summary

Source Protocol	Metric	Metric Type	Tag	Subnets	Distribute List	Redistribute
Connected	0	External Type 2	0	Disable	Disable	Disable
Static	0	External Type 2	0	Disable	Disable	Disable
RIP	0	External Type 2	0	Disable	Disable	Disable

The **OSPF Route Redistribution Summary** page contains the following fields:

- **Source** — The Source Route to be redistributed by OSPF.
- **Redistribute** — Specify whether to allow the routes learned through this protocol to be redistributed.
- **Metric** — The Metric of redistributed routes for the given Source Route. Displays 0 when not configured.
- **Metric Type** — The OSPF metric type of redistributed routes.
- **Tag** — The tag field in routes redistributed. This field displays the tag value if the source was preconfigured, otherwise 0 is displayed.
- **Subnets** — Specify whether the subnetted routes should be redistributed (**Enable**) or not (**Disable**).
- **Distribute List** — The access list that filters the routes to be redistributed by the destination protocol. Displays 0 when not configured.
- **Redistribute** — Redistribute among other VLANs in the domain.

Displaying the Route Redistribution Summary Using CLI Commands

For information about the CLI command that performs this function, see the following chapter in the *CLI Reference Guide*:

- OSPF Commands

The following table summarizes the equivalent CLI commands for this feature.

Table 9-18. OSPF Route Redistribution Summary Command

CLI Command	Description
show ip ospf	Displays OSPF route redistribution summary data.

Nonstop Forwarding OSPF Graceful Restart

The OSPF protocol can be configured to perform a “graceful restart” in conjunction with the nonstop forwarding feature (see “Nonstop Forwarding” on page 258) for stacked switches. When OSPF graceful restart is enabled and the management unit in a stack fails, the hardware can continue to forward packets using OSPF routes while a backup switch takes over management unit responsibility.

Graceful restart uses the concept of “helpful neighbors”. A fully adjacent router enters helper mode when it receives a link state announcement (LSA) from the restarting management unit indicating its intention of performing a graceful restart. In helper mode, a switch continues to advertise to the rest of the network that they have full adjacencies with the restarting router, thereby avoiding announcement of a topology change and the potential for flooding of LSAs and shortest-path-first (SPF) runs (which determine OSPF routes). Helpful neighbors continue to forward packets through the restarting router. The restarting router relearns the network topology from its helpful neighbors.

Graceful restart can be enabled for either planned or unplanned restarts, or both. A planned restart is initiated by the operator (see “Enabling and Disabling NSF” on page 258). The operator may initiate a failover in order to take the management unit out of service (for example, to address a partial hardware

failure), to correct faulty system behavior which cannot be corrected through less severe management actions, or other reasons. An unplanned restart is an unexpected failover caused by a fatal hardware failure of the management unit or a software hang or crash on the management unit.

To configure the OSPF graceful restart feature, click **Routing** → **OSPF** → **NSF OSPF Summary** in the navigation tree.

Figure 9-21. NSF OSPF Summary

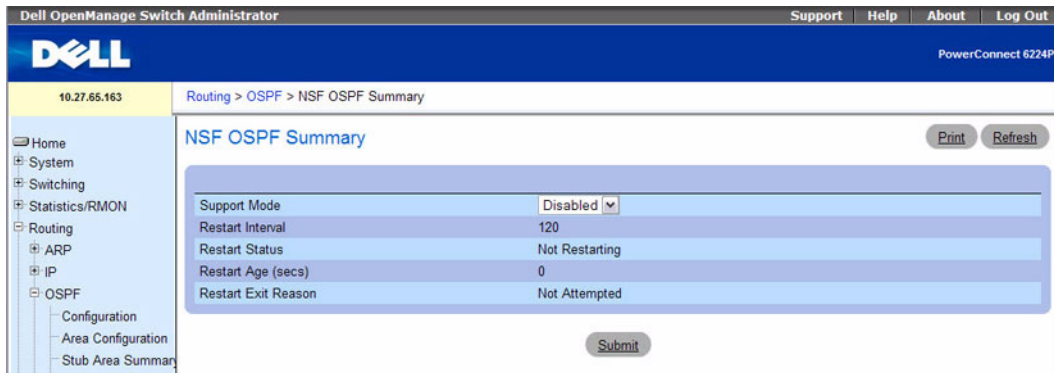

- **Support Mode** — Enables or disables OSPF to perform graceful restarts. The following options are available:
 - **Planned**—OSPF will perform a graceful restart for planned restarts. A planned restart is a failover initiated by the administrator (see "Enabling and Disabling NSF" on page 258).
 - **Always**—OSPF will perform a graceful restart for all planned and unplanned warm restart events.
 - **Disable**—OSPF will not perform graceful restarts.
- **Restart Interval** — The grace period during which a neighboring router will be in the helper state after receiving notice that the management unit is performing a graceful restart.
- **Restart Status** — Displays the restart status of OSPF Helper feature. The possible values are:
 - Not Restarting
 - Planned Restart
 - Unplanned Restart
- **Restart Age (secs)** — Displays the amount of time since the last restart occurred.
- **Restart Exit Reason** — Displays how the master unit on the stack last started up. The possible values are:
 - **Not Attempted**—Graceful restart has not been attempted.
 - **In Progress**—Restart is in progress.
 - **Completed**—The previous graceful restart completed successfully.

- Timed Out—The previous graceful restart timed out.
- Topology Changed—The previous graceful restart terminated prematurely because of a topology change.

If you change the Support Mode, click **Submit** to save your change.

Click **Refresh** to redisplay the page with the latest values from the switch.

Enabling the NSF OSPF Graceful Restart Using CLI Commands

For information about the CLI command that performs this function, see the following chapter in the *CLI Reference Guide*:

- OSPF Commands

The following table summarizes the equivalent CLI commands for this feature.

Table 9-19. NSF OSPF Graceful Restart Command

CLI Command	Description
nsf	Enables non-stop forwarding.
nsf helper	Enables helpful neighbor functionality for the OSPF protocol.
nsf helper strict-lsa-checking	Requires that an OSPF helpful neighbor exit helper mode whenever a topology change occurs.
show ip ospf	Displays information relevant to the OSPF router.
show ip ospf neighbor	This command displays information about OSPF neighbors.

BOOTP/DHCP Relay Agent

BootP/DHCP Relay Agent enables BootP/DHCP clients and servers to exchange BootP/DHCP messages across different subnets. The relay agent receives the requests from the clients, and checks the valid hops and giaddr fields. If the number of hops is greater than the configured, the agent assumes the packet is looped through the agents and discards the packet. If giaddr field is zero the agent must fill in this field with the IP address of the interface on which the request was received. The agent unicasts the valid packets to the next configured destination. The server responds with a unicast BOOTREPLY addressed to the relay agent closest to the client as indicated by giaddr field. Upon reception of the BOOTREPLY from the server, the agent forwards this reply as broadcast or unicast on the interface form where the BOOTREQUEST was arrived. This interface can be identified by giaddr field.

The PowerConnect 6200 Series DHCP component also supports DHCP relay agent options to identify the source circuit when customers are connected to the Internet with high-speed modem. The relay agent inserts these options when forwarding the request to the server and removes them when sending the reply to the clients.

If an interface has more than one IP address, the relay agent should use the primary IP address configured as its relay agent IP address.

The **BOOTP/DHCP Relay Agent** menu page contains links to web pages that configure and display BOOTP/DHCP relay agent. To display this page, click **Routing** → **BOOTP/DHCP Relay Agent** in the tree view. Following are the web pages accessible from this menu page:

- **BOOTP/DHCP Relay Agent Configuration**

BOOTP/DHCP Relay Agent Configuration

Use the **BOOTP/DHCP Relay Agent Configuration** page to configure and display a BOOTP/DHCP relay agent.

To display the page, click **Routing** → **BOOTP/DHCP Relay Agent** → **Configuration** in the tree view.

Figure 9-22. BOOTP/DHCP Relay Agent Configuration

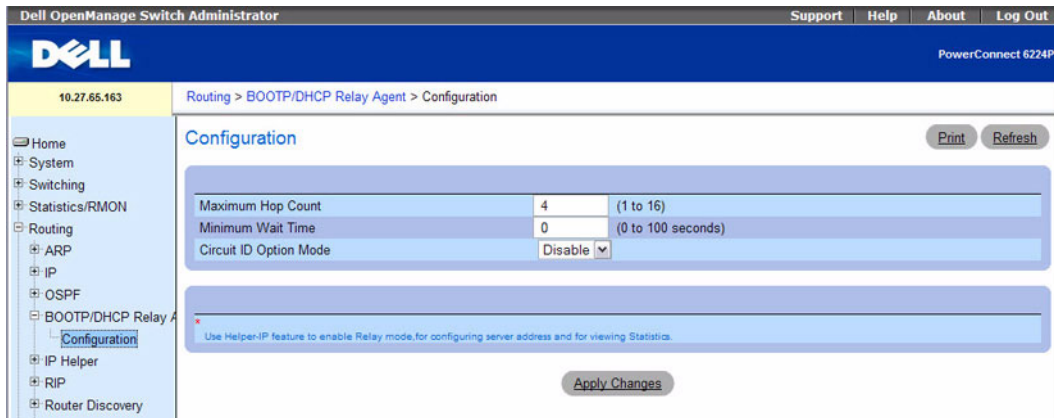

The **BOOTP/DHCP Relay Agent Configuration** page contains the following fields:

- **Maximum Hop Count** — Enter the maximum number of hops a client request can take before being discarded.
- **Server IP Address** — Enter either the IP address of the BOOTP/DHCP server or the IP address of the next BOOTP/DHCP Relay Agent.
- **Admin Mode** — Select Enable or Disable from the drop-down menu. When you select Enable, BOOTP/DHCP requests are forwarded to the IP address you entered in the Server IP address field.
- **Minimum Wait Time (secs)** — Enter a time in seconds. This value is compared to the time stamp in the client's request packets, which should represent the time since the client was powered up. Packets are only forwarded when the time stamp exceeds the minimum wait time.
- **Circuit ID Option Mode** — Select Enable or Disable from the drop-down menu. If you select Enable, the relay agent adds Option 82 header packets to the DHCP Request packets before forwarding them to the server, and strips them off while forwarding the responses to the client.

Configuring BOOTP/DHCP

1. Open the **BOOTP/DHCP Configuration** page.
2. Enter data in the fields as needed.
3. Click **Apply Changes** when finished.

The BOOTP/DHCP data is configured, and the device is updated.

Configuring BOOTP/DHCP using CLI Commands

For information about the CLI commands that perform this function, see the following chapter in the *CLI Reference Guide*:

- DHCP and BOOTP Relay Commands

The following table summarizes the equivalent CLI commands for this feature.

Table 9-20. BOOTP and DHCP Commands

CLI Command	Description
bootpdhcprelay cidridoptmode	Enables the circuit ID option and remote agent ID mode for BootP/DHCP Relay on the system.
bootpdhcprelay maxhopcount	Configures the maximum allowable relay agent hops for BootP/DHCP Relay on the system.
bootpdhcprelay minwaittime	Configures the minimum wait time in seconds for BootP/DHCP Relay on the system.
show bootpdhcprelay	Shows the the BootP/DHCP Relay information.

IP Helper

The IP Helper feature allows the switch to forward certain configured UDP broadcast packets to a particular IP address. This allows various applications, such as the DHCP relay agent, to reach servers on non-local subnets, even if the application was designed to assume a server is always on a local subnet and uses broadcast packets (with either the limited broadcast address 255.255.255.255, or a network directed broadcast address) to reach the server.

You can configure relay entries both globally and on specific routing interfaces. Each relay entry maps an ingress interface and destination UDP port number to a single IPv4 address (the helper address). You can configure multiple relay entries for the same interface and UDP port, in which case the relay agent relays matching packets to each server address. Interface configuration takes priority over global configuration. In other words, if the destination UDP port of a packet matches any entry on the ingress interface, the packet is handled according to the interface configuration. If the packet does not match any entry on the ingress interface, the packet is handled according to the global IP helper configuration.

IP Helper Global Configuration

Use the IP Helper Global Configuration page to add, show, or delete UDP Relay and Helper IP configuration

To display the page, click **Routing** → **IP Helper** → **Global Configuration** in the tree view.

Figure 9-23. IP Helper Global Configuration

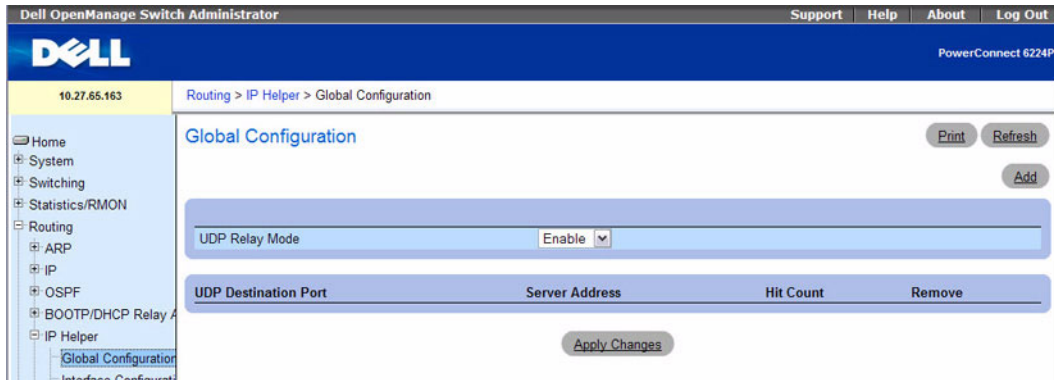

The IP Helper **Global Configuration** page contains the following fields:

- **UDP Relay Mode** — Use the menu to enable or disable the UDP relay mode. You must enable the UDP Relay Mode to relay any other protocols for which an IP helper address has been configured. By default UDP Relay Mode is Enabled.
- **UDP Destination Port** — Identifies destination UDP port number of UDP packets to be relayed. Table 9-21 lists UDP Port allocations.

Table 9-21. UDP Port Allocations

UDP Port Number	Acronym	Application
7	Echo	Echo
11	SysStat	Active User
15	NetStat	NetStat
17	Quote	Quote of the day
19	CHARGEN	Character Generator
20	FTP-data	FTP Data
21	FTP	FTP
37	Time	Time
42	NAMESERVER	Host Name Server
43	NICNAME	Who is
53	DOMAIN	Domain Name Server
69	TFTP	Trivial File Transfer
111	SUNRPC	Sun Microsystems Rpc
123	NTP	Network Time
137	NetBiosNameService	NT Server to Station Connections
138	NetBiosDatagramService	NT Server to Station Connections
139	NetBios	SessionServiceNT Server to Station Connections
161	SNMP	Simple Network Management
162	SNMP-trap	Simple Network Management Traps
513	who	Unix Rwho Daemon
514	syslog	System Log
525	timed	Time Daemon

- **Server Address** — The IPv4 address of the server to which packets are relayed for the specific UDP Destination Port.
- **Hit Count** — The number of times a packet has been forwarded or discarded according to this entry.
- **Remove** — Removes the specified **UDP Relay** when selected and **Apply Changes** is pressed.

Adding an IP Helper Entry

1. Open the IP Helper Global Configuration page.

- Click **Add** to display the **Add Helper IP Address** page:

Figure 9-24. Add Helper IP Address

- Select a UDP Destination port name from the menu or enter the UDP Destination Port ID. Select the Default Set to configure for the relay entry for the default set of protocols.

NOTE: If the DefaultSet option is specified, the device by default forwards UDP Broadcast packets for the following services: IEN-116 Name Service (port 42), DNS (port 53), NetBIOS Name Server (port 137), NetBIOS Datagram Server (port 138), TACACS Server (Port 49), and Time Service (port 37).

- Enter the IP address of the server to which the packets with the given UDP Destination Port will be relayed.
- Click **Apply Changes**.

The UDP/Helper Relay is added and the device is updated.

Configuring IP Helper Global Settings Using CLI Commands

For information about the CLI commands that perform this function, see the following chapter in the *CLI Reference Guide*:

- IP Helper Commands

The following table summarizes the equivalent CLI commands for this feature.

Table 9-22. IP Helper Global Commands

CLI Command	Description
ip helper-address (global configuration)	Configures the relay of certain UDP broadcast packets received on any interface.
ip helper enable	Enables relay of UDP packets.
show ip helper-address	Displays the IP helper address configuration.

IP Helper Interface Configuration

Use the IP Helper **Interface Configuration** page to add, show, or delete UDP Relay and Helper IP configuration for a specific interface.

To display the page, click **Routing** → **IP Helper** → **Interface Configuration** in the tree view.

Figure 9-25. IP Helper Interface Configuration

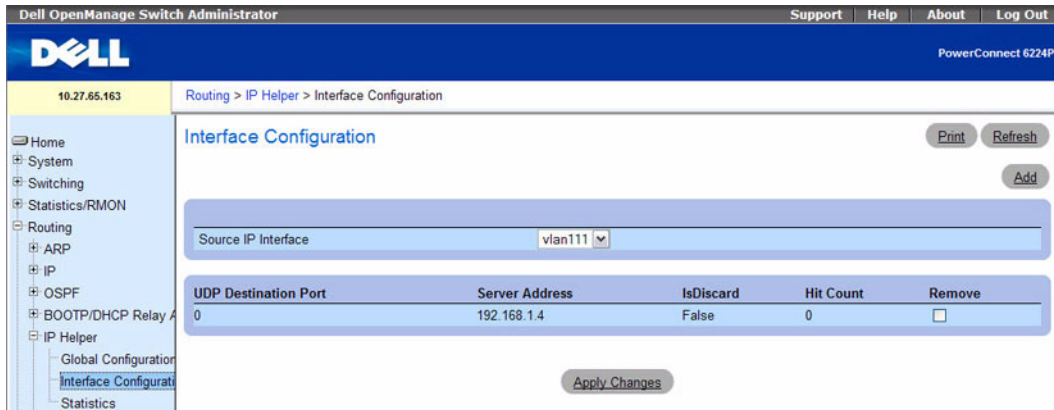

The IP Helper **Interface Configuration** page contains the following fields:

- **Source IP Interface** — Select the interface to use for UDP/Helper relays. Select All to configure relay entries on all available interfaces.
- **UDP Destination Port** — Identifies destination UDP port number of UDP packets to be relayed. For a list of UDP Port allocations, see Table 9-21.
- **Server Address** — The IPv4 address of the server to which packets are relayed for the specific UDP Destination Port.
- **IsDiscard** — If True, packets arriving on the given interface with the given destination UDP port are discarded rather than relayed. Discard entries are used to override global IP helper address entries which otherwise might apply to a packet.
- **Hit Count** — The number of times a packet has been forwarded or discarded according to this entry.
- **Remove** — Select this option and click **Apply Changes** to remove the relay from the selected source IP interface.

Adding an IP Helper Entry to an Interface

1. Open the IP Helper **Interface Configuration** page.
2. Click **Add** to display the **Interface Configuration Add** page:

Figure 9-26. Add Helper IP Address

The screenshot shows a web-based configuration interface for adding a helper IP address. The title is "Add Helper IP Address" with "Print" and "Refresh" buttons. The form fields are: Interface (vian10), UDP Destination Port (Other), UDP Destination Port (0 to 65535), Discard (False), and Server Address (X.X.X.X). At the bottom, there are "Apply Changes" and "Back" buttons.

3. Select the interface to use for the relay.
4. Select a UDP Destination port name from the menu or enter the UDP Destination Port ID. Select the Default Set to configure for the relay entry for the default set of protocols.
NOTE: If the DefaultSet option is specified, the device by default forwards UDP Broadcast packets for the following services: IEN-116 Name Service (port 42), DNS (port 53), NetBIOS Name Server (port 137), NetBIOS Datagram Server (port 138), TACACS Server (Port 49), and Time Service (port 37).
5. Choose whether to discard (True) or keep (False) packets arriving on the given interface with the given destination UDP port.
6. Enter the IP address of the server to which the packets with the given UDP Destination Port will be relayed.
7. Click **Apply Changes**.
The UDP/Helper Relay is added to the interface and the device is updated.

Configuring IP Helper Interfaces Using CLI Commands

For information about the CLI commands that perform this function, see the following chapter in the *CLI Reference Guide*:

- IP Helper Commands

The following table summarizes the equivalent CLI commands for this feature.

Table 9-23. IP Helper Interface Commands

CLI Command	Description
ip helper-address (interface configuration)	Configures the relay of certain UDP broadcast packets received on a specific interface.

IP Helper Statistics

Use the IP Helper **Statistics** page to view UDP Relay Statistics for the switch.

To display the page, click **Routing** → **IP Helper** → **Statistics** in the tree view.

Figure 9-27. IP Helper Statistics



The IP Helper Statistics page contains the following fields:

- **DHCP Client Messages Received** — The number of valid messages received from a DHCP client. The count is only increased if IP helper is enabled globally, the ingress routing interface is up, and the packet passes a number of validity checks, such as having a TTL >1 and having valid source and destination IP addresses.
- **DHCP Client Messages Relayed** — The number of DHCP client messages relayed to a server. If a message is relayed to multiple servers, the count is increased once for each server.
- **DHCP Server Messages Received** — The number of DHCP responses received from the DHCP server. This count only includes messages that the DHCP server unicasts to the relay agent for relay to the client.
- **DHCP Server Messages Relayed** — Specifies the number of DHCP server messages relayed to a client.
- **UDP Client Messages Received** — The number of valid UDP packets received. This count includes DHCP messages and all other protocols relayed. Conditions are similar to those for the first statistic in this table.
- **UDP Client Messages Relayed** — The number of UDP packets relayed. This count includes DHCP messages relayed as well as all other protocols. The count is increased for each server to which a packet is sent.
- **DHCP Client Messages Hop Count Exceeded Max** — The number of DHCP client messages received whose hop count is larger than the maximum allowed. The maximum hop count is a configurable value. A log message is written for each such failure. The DHCP relay agent does not relay these packets.

- **DHCP Pkts Rcvd Too Early** — The number of DHCP client messages received whose secs field is less than the minimum value. The minimum secs value is a configurable value. A log message is written for each such failure. The DHCP relay agent does not relay these packets.
- **Received DHCP Client Messages With Giaddr As Local Address** — The number of DHCP client messages received whose gateway address, giaddr, is already set to an IP address configured on one of the relay agents own IP addresses. In this case, another device is attempting to spoof the relay agents address. The relay agent does not relay such packets. A log message gives details for each occurrence.
- **UDP Pkts With Expired TTL** — The number of packets received with TTL of 0 or 1 that might otherwise have been relayed.
- **UDP Pkts Discarded** — The number of packets ignored by the relay agent because they match a discard relay entry.

Viewing IP Helper Statistics Using CLI Commands

For information about the CLI commands that perform this function, see the following chapter in the *CLI Reference Guide*:

- IP Help Commands

The following table summarizes the equivalent CLI commands for this feature.

Table 9-24. IP Helper Statistics Commands

CLI Command	Description
show ip helper statistics	Displays the number of DHCP and other UDP packets processed and relayed by the UDP relay agent.
clear ip helper statistics	Resets (to 0) the statistics displayed in show ip helper statistics.

RIP

Routing Information Protocol (RIP) is an Interior Gateway Protocol (IGP) based on the Bellman-Ford algorithm and targeted at smaller networks (network diameter no greater than 15 hops). The routing information is propagated in RIP update packets that are sent out both periodically and in the event of a network topology change. On receipt of a RIP update, depending on whether the specified route exists or does not exist in the route table, the router may modify, delete or add the route to its route table. Route preferences are conveyed through a configurable metric that indicates the distance for each destination.

The **RIP** menu page contains links to web pages that configure and display RIP parameters and data. To display this page, click **Routing** → **RIP** in the tree view. Following are the web pages accessible from this menu page:

- RIP Configuration
- RIP Interface Summary
- RIP Interface Configuration

- RIP Route Redistribution Configuration
- RIP Route Redistribution Summary

RIP Configuration

Use the **RIP Configuration** page to enable and configure or disable RIP in Global mode. To display the page, click **Routing** → **RIP** → **Configuration** in the tree view.

Figure 9-28. RIP Configuration

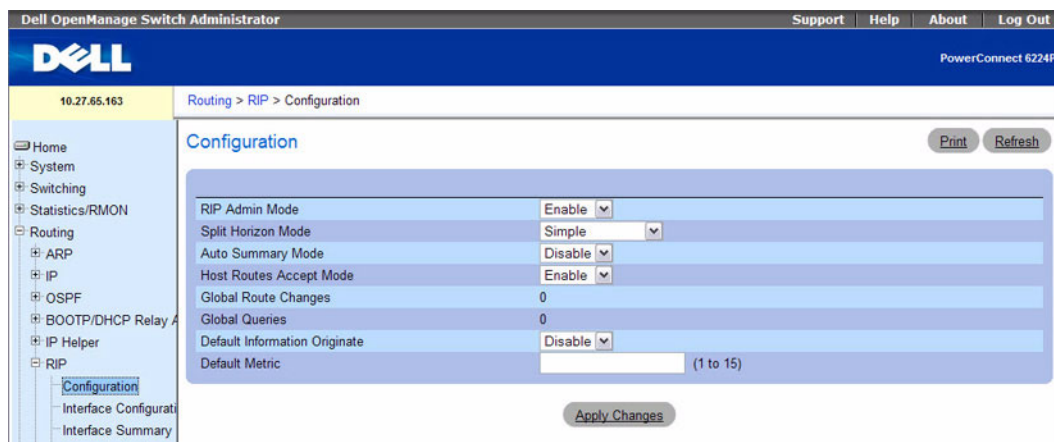

The **RIP Configuration** page contains the following fields:

- **RIP Admin Mode** — Select Enable or Disable from the drop-down menu. If you select Enable, RIP is enabled for the switch. The default is Disable.
- **Split Horizon Mode** — Select None, Simple, or Poison Reverse from the drop-down menu. The default is Simple. Split horizon is a technique for avoiding problems caused by including routes in updates sent to the router from which the route was originally learned. The options are:
 - **None** — No special processing for this case.
 - **Simple** — A route is not included in updates sent to the router from which it was learned.
 - **Poison Reverse** — A route is included in updates sent to the router from which it was learned, but the metric is set to infinity.
- **Auto Summary Mode** — Select Enable or Disable from the drop-down menu. If you select Enable, groups of adjacent routes are summarized into single entries, in order to reduce the total number of entries. The default is Enable.
- **Host Routes Accept Mode** — Select Enable or Disable from the drop-down menu. If you select Enable, the router accepts host routes. The default is Enable.

- **Global Route Changes** — Displays the number of route changes made to the IP Route Database by RIP. This does not include the refresh of a route's age.
- **Global Queries** — Displays the number of responses sent to RIP queries from other systems.
- **Default Information Originate** — Enable or Disable Default Route Advertise.
- **Default Metric** — Sets a default for the metric of redistributed routes. This field displays the default metric if one has already been set, or blank if not configured earlier. Valid values are 1 to 15.

Configuring RIP

1. Open the **RIP Configuration** page.
2. Enter data in the fields as needed.
3. Click **Apply Changes** when finished.
RIP is configured, and the device is updated.

Configuring RIP Using CLI Commands

For information about the CLI commands that perform this function, see the following chapter in the *CLI Reference Guide*:

- Routing Information Protocol (RIP) Commands

The following table summarizes the equivalent CLI commands for this feature.

Table 9-25. RIP Global Configuration Commands

CLI Command	Description
auto-summary	Enables the RIP auto-summarization mode.
default-information originate	Controls the advertisement of default routes.
default-metric	Sets a default for the metric of distributed routes.
distance rip	Sets the route preference value of RIP in the router.
enable	Resets the default administrative mode of RIP in the router (active).
hostroutesaccept	Enables the RIP hostroutesaccept mode.
router rip	Enters Router RIP mode.
show ip rip	Displays information relevant to the RIP router.
split-horizon	Sets the RIP split horizon mode.

RIP Interface Configuration

Use the **RIP Interface Configuration** page to enable and configure or to disable RIP on a specific interface.

To display the page, click **Routing** → **RIP** → **Interface Configuration** in the tree view.

Figure 9-29. RIP Interface Configuration

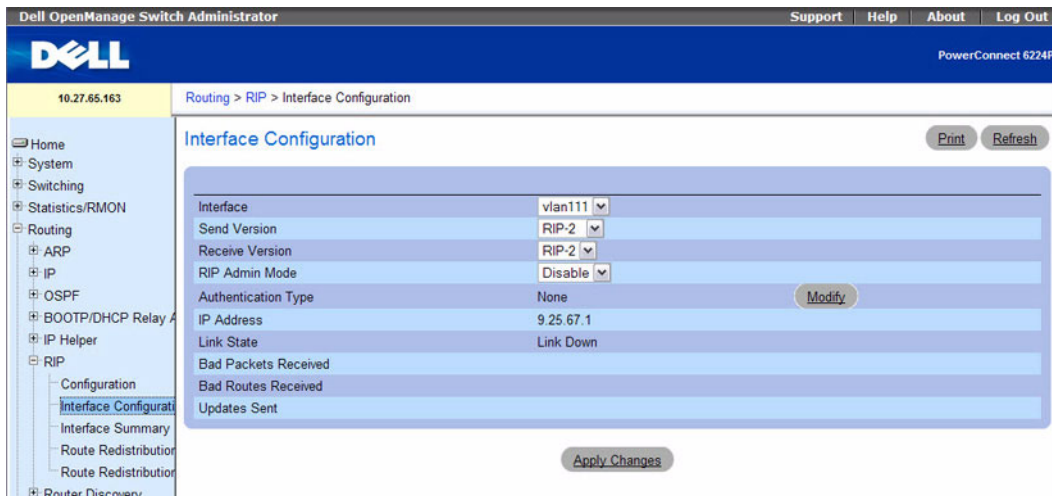

The **RIP Interface Configuration** page contains the following fields:

- **Interface** — Select the interface for which data is to be configured from the drop-down menu.
- **Send Version** — RIP Version that router sends with its routing updates. The default is RIP-2. Possible values are:
 - **RIP-1** — send RIP version 1 formatted packets through broadcast.
 - **RIP-1c** — RIP version 1 compatibility mode. Send RIP version 2 formatted packets through broadcast.
 - **RIP-2** — send RIP version 2 packets using multicast.
 - **None** — no RIP control packets are sent.
- **Receive Version** — RIP Version of the routing updates that the router must accept. The default is Both. Possible values are:
 - **RIP-1** — accept only RIP version 1 formatted packets.
 - **RIP-2** — accept only RIP version 2 formatted packets.
 - **Both** — accept packets in either format.
- **None** — no RIP control packets is accepted.

- **RIP Admin Mode** — Select Enable or Disable from the drop-down menu. Before you enable RIP version 1 or version 1c on an interface, you must first enable network directed broadcast mode on the corresponding interface. The default value is Disable.
- **Authentication Type** — You may select an authentication type other than None by clicking the **Modify** button. You then see a new screen, where you can select the authentication type from the drop-down menu. Possible values are:
 - **None** — This is the initial interface state. If you select this option from the drop-down menu on the second screen and click **Apply Changes**, you are returned to the first screen without any authentication protocols being run.
 - **Simple** — If you select Simple you are prompted to enter an authentication key. This key is included, in the clear, in the RIP header of all packets sent on the network. All routers on the network must be configured with the same key.
 - **Encrypt** — If you select Encrypt you are prompted to enter both an authentication key and an authentication ID. Encryption uses the MD5 Message-Digest algorithm. All routers on the network must be configured with the same key and ID.
- **IP Address** — Displays the IP Address of the router interface.
- **Link State** — Specifies whether the RIP interface is up or down.
- **Bad Packets Received** — Displays the number of RIP packets that were found to be invalid or corrupt. This explicitly does NOT include full updates sent containing new information.
- **Bad Routes Received** — Displays the number of routes, in valid RIP packets, which were ignored for any reason, for example, the number of triggered RIP updates actually sent on this interface. This explicitly does NOT include full updates sent containing new information.
- **Updates Sent** — Displays the number of Route updates sent.

Configuring the RIP Interface

1. Open the **RIP Interface Configuration** page.
2. Specify the interface for which data is to be configured.
3. Enter data into the fields as needed:
 - **Send Version** — From the drop-down box, select **None**, **RIP-1**, **RIP-1c**, or **RIP2**.
 - **Receive Version** — From the drop-down box select **None**, **RIP-1**, **RIP-2**, or **Both**.
 - **RIP Admin Mode** — Select **Enable** or **Disable**.
 - **Authentication Type** — Click the **Modify** button to configure different Authentication Types.
4. Click **Apply Changes** when finished.

The RIP interface is configured, and the device is updated.

Selecting an Authentication Method

1. Open the **RIP Interface Configuration** page.

2. Specify the interface for which the authentication method is to be configured.
3. Click **Modify**.
The Authentication Method page displays.
4. Specify the Authentication Type (None, Simple, or Encrypt) from the drop-down menu.
5. If you specify Simple or Encrypt as the Authentication Type, additional fields appear. Enter the Authentication Key (Simple or Encrypt) and Authentication Key ID (Encrypt).
6. Click **Apply Changes**.
7. The authentication method is updated, and the device is updated.

Configuring the RIP Interface with the CLI Commands

For information about the CLI commands that perform this function, see the following chapter in the *CLI Reference Guide*:

- Routing Information Protocol (RIP) Commands

The following table summarizes the equivalent CLI commands for this feature.

Table 9-26. RIP Interface Configuration Commands

CLI Command	Description
ip rip	Enables RIP on a router interface.
ip rip authentication	Sets the RIP Version 2 Authentication Type and Key for the specified interface.
ip rip receive version	Configures the interface to allow RIP control packets of the specified version(s) to be received.
ip rip send version	Configures the interface to allow RIP control packets of the specified version to be sent.
show ip rip interface	Displays information related to a particular RIP interface.

RIP Interface Summary

Use the **RIP Interface Summary** page to display RIP configuration status on an interface.

To display the page, click **Routing** → **RIP** → **Interface Summary** in the tree view.

Figure 9-30. RIP Interface Summary

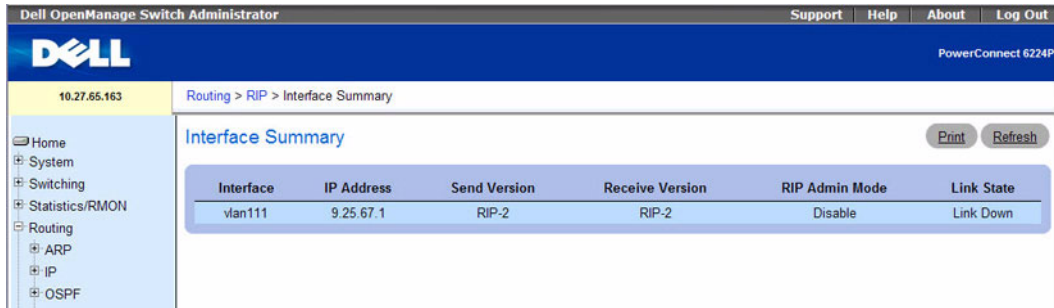

The **RIP Interface Summary** page displays the following fields:

- **Interface** — The interface, such as the routing-enabled VLAN on which RIP is enabled.
- **IP Address** — The IP Address of the router interface.
- **Send Version** — Specifies the RIP version to which RIP control packets sent from the interface conform. The default is RIP-2. Possible values are:
 - **RIP-1** — RIP version 1 packets are sent using broadcast.
 - **RIP-1c** — RIP version 1 compatibility mode. RIP version 2 formatted packets are transmitted using broadcast.
 - **RIP-2** — RIP version 2 packets are sent using multicast.
 - **None** — RIP control packets are not transmitted.
- **Receive Version** — Specifies which RIP version control packets are accepted by the interface. The default is Both. Possible values are:
 - **RIP-1** — only RIP version 1 formatted packets are received.
 - **RIP-2** — only RIP version 2 formatted packets are received.
 - **Both** — packets are received in either format.
 - **None** — no RIP control packets are received.
- **RIP Admin Mode** — Specifies whether RIP is Enabled or Disabled on the interface.
- **Link State** — Specifies whether the RIP interface is up or down.

Displaying RIP Interface Summary Using CLI Commands

For information about the CLI command that performs this function, see the following chapter in the *CLI Reference Guide*:

- Routing Information Protocol (RIP) Commands

The following table summarizes the equivalent CLI commands for this feature.

Table 9-27. RIP Interface Summary Command

CLI Command	Description
show ip rip interface brief	Displays general information for each RIP interface.

RIP Route Redistribution Configuration

Use the **RIP Route Redistribution Configuration** page to configure the RIP Route Redistribution parameters. The allowable values for each field are displayed next to the field. If any invalid values are entered, an alert message is displayed with the list of all the valid values.

Static Reject Routes

A static reject route is a static route to discard the packets to a particular destination, thereby forcing a black-hole routing behavior for a particular set of IP prefixes. Static reject routes can help prevent a routing loop in the network if a default route is configured on a router. Static reject routes also help protect against a DOS attack on a router with unwanted destination addresses.

 **NOTE:** Static reject routes are not redistributed by OSPF or RIP.

Starting with software release 3.0, you can select Static Reject as a route type from the Route Type field on the following pages under the **Routing** → **Router** menu:

- Route Entry Configuration
- Configured Routes

 **NOTE:** For a static reject route, the next hop interface value is Null0. Packets to the network address specified in static reject routes are intentionally dropped.

To display the page, click **Routing** → **RIP** → **Route Redistribution Configuration** in the tree view.

Figure 9-31. RIP Route Redistribution Configuration

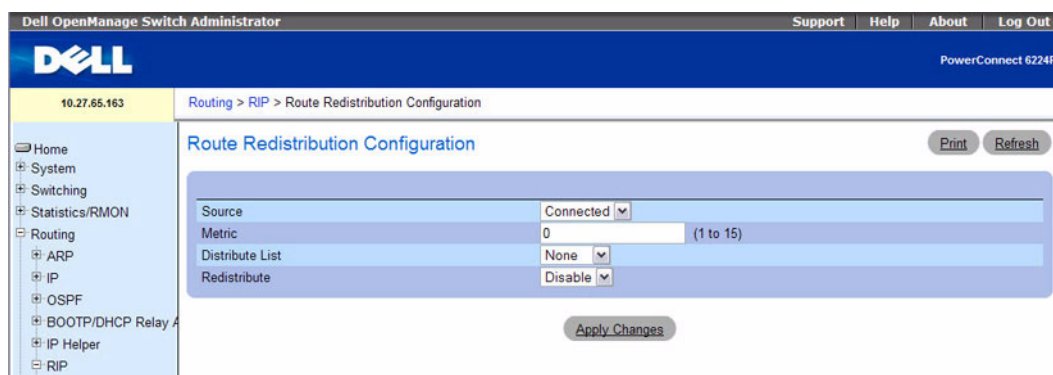

The **RIP Route Redistribution Configuration** page contains the following fields:

- **Source** — Select the type of source route to configure for redistribution by RIP. Possible values are:
 - **Static**
 - **Connected**
 - **OSPF**
- **Metric** — Sets the metric value to be used as the metric of redistributed routes. This field displays the metric if the source was pre-configured and can be modified. The valid values are 1 to 15.
- **Distribute List** — Select the Access List that filters the routes to be redistributed by the destination protocol. Only permitted routes are redistributed.

The drop-down menu lists the ACLs configured through the pages under **Switching**→**Network Security**→**Access Control Lists**→**IP Access Control Lists**. When used for route filtering, the only fields in an access list that get used are:

- Source IP Address and netmask
- Destination IP Address and netmask
- Action (Permit or Deny)

All other fields (source and destination port, precedence, tos, etc.) are ignored.

The source IP address is compared to the destination IP address of the route. The source IP netmask in the access list rule is treated as a wildcard mask, indicating which bits in the source IP address must match the destination address of the route.



NOTE: A 1 in the mask indicates a Don't Care in the corresponding address bit.

When an access list rule includes a destination IP address and netmask (an extended access list), the destination IP address is compared to the network mask of the destination of the route. The destination netmask in the access list serves as a wildcard mask, indicating which bits in the route's destination mask are significant for the filtering operation.

- **Redistribute** — Enables or disables the redistribution for the selected source protocol. This field has to be enabled in order to be able to configure any of the route redistribution attributes.

Creating a Configured Source

1. Open the **RIP Route Redistribution Configuration** page.
2. Select an Available Source to configure.
3. Specify values for the remaining fields.
4. Click **Apply Changes**.

The specified Source is now configured, and the device is updated.

Modifying a Configured Source

1. Open the **RIP Route Redistribution Configuration** page.

2. Select the Configured Source to modify.
3. Change values on this screen as needed.
4. Click **Apply Changes**
Specified changes are saved, and the device is updated.

Configuring RIP Route Redistribution using CLI Command

For information about the CLI commands that perform this function, see the following chapter in the *CLI Reference Guide*:

- Routing Information Protocol (RIP) Commands

The following table summarizes the equivalent CLI commands for this feature.

Table 9-28. RIP Route Redistribution Commands

CLI Command	Description
redistribute	Configures OSPF protocol to allow redistribution of routes from the specified source protocol/routers.
distribute-list out	Specifies the access list to filter routes received from the source protocol.

RIP Route Redistribution Summary

Use the **RIP Route Redistribution Summary** page to display Route Redistribution configurations. To display the page, click **Routing** → **RIP** → **Route Redistribution Summary** in the tree view.

Figure 9-32. RIP Route Redistribution Summary

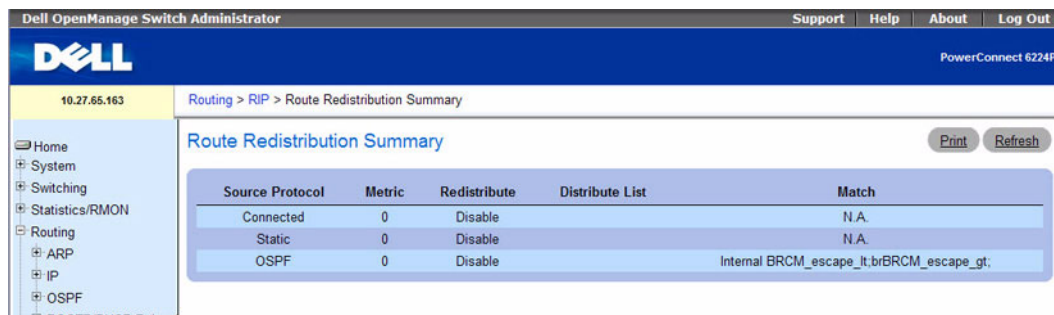

Source Protocol	Metric	Redistribute	Distribute List	Match
Connected	0	Disable		N.A.
Static	0	Disable		N.A.
OSPF	0	Disable	Internal BRCM_escape_lt,brBRCM_escape_gt;	

The **RIP Route Redistribution Summary** page contains the following fields:

- **Source** — The source route to be redistributed by RIP.
- **Metric** — The metric of redistributed routes for the given source route. Displays 0 when not configured.
- **Redistribute** — Shows whether route redistribution is enabled for the source.
- **Distribute List** — The access list that filters the routes to be redistributed by the destination protocol. If the distribute list is not configured, the field is blank.
- **Match** — Shows the list of routes redistributed when OSPF is selected as the source, which can be any of the following:
 - **Match Internal** — Shows whether redistribution of OSPF internal routes is enabled.
 - **Match External Type 1** — Shows whether the redistribution of OSPF external type 1 routes is enabled.
 - **Match External Type 2** — Shows whether the redistribution of OSPF external type 2 routes is enabled.
 - **Match NSSA External Type 1** — Shows whether the redistribution of OSPF NSSA external type 1 routes is enabled.
 - **Match NSSA External Type 2** — Shows whether the redistribution of OSPF NSSA external type 2 routes is enabled.

Displaying RIP Route Redistribution Summary Using CLI Commands

For information about the CLI command that performs this function, see the following chapter in the *CLI Reference Guide*:

- Routing Information Protocol (RIP) Commands

The following table summarizes the equivalent CLI commands for this feature.

Table 9-29. RIP Route Redistribution Summary Command

CLI Command	Description
show ip rip	Displays IP RIP redistribution summary data.

Router Discovery

The Router Discovery protocol is used by hosts to identify operational routers on the subnet. Router Discovery messages are of two types: “Router Advertisements” and “Router Solicitations.” The protocol mandates that every router periodically advertise the IP Addresses it is associated with. Hosts listen for these advertisements and discover the IP Addresses of neighboring routers.

The **Router Discovery** menu page contains links to web pages that configure and display Router Discovery data. To display this menu, click **Routing** → **Router Discovery** in the tree view. Following are the web pages accessible from this menu page:

- Router Discovery Configuration
- Router Discovery Status

Router Discovery Configuration

Use the **Router Discovery Configuration** page to enter or change Router Discovery parameters.

To display the page, click **Routing** → **Router Discovery** → **Configuration** in the tree view.

Figure 9-33. Router Discovery Configuration

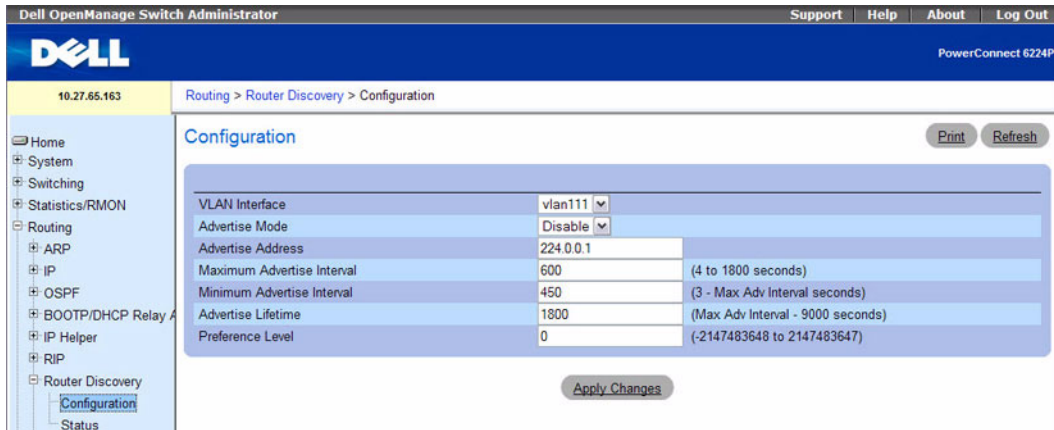

The **Router Discovery Configuration** page contains the following fields:

- **VLAN Interface** — Select the router interface for which data is to be configured.
- **Advertise Mode** — Select Enable or Disable from the drop-down menu. If you select Enable, Router Advertisements are transmitted from the selected interface.
- **Advertise Address** — Enter the IP Address to be used to advertise the router.
- **Maximum Advertise Interval (secs)** — Enter the maximum time (in seconds) allowed between router advertisements sent from the interface.
- **Minimum Advertise Interval (secs)** — Enter the minimum time (in seconds) allowed between router advertisements sent from the interface.
- **Advertise Lifetime (secs)** — Enter the value (in seconds) to be used as the lifetime field in router advertisements sent from the interface. This is the maximum length of time that the advertised addresses are to be considered as valid router addresses by hosts.
- **Preference Level** — Specify the preference level of the router as a default router relative to other routers on the same subnet. Higher numbered addresses are preferred. You must enter an integer.

Configuring Router Discovery

1. Open the **Router Discovery Configuration** page.
2. Select the router interface to be configured.
3. Configure data as needed for the remaining fields.
4. Click **Apply Changes**
Specified configuration changes are saved, and the device is updated.

Configuring Router Discovery Using CLI Commands

For information about the CLI commands that perform this function, see the following chapter in the *CLI Reference Guide*:

- Router Discovery Protocol Commands

The following table summarizes the equivalent CLI commands for this feature.

Table 9-30. Router Discovery Commands

CLI Command	Description
ip irdp	Enables Router Discovery on an interface.
ip irdp address	Configures the address that the interface uses to send the router discovery advertisements.
ip irdp holdtime	Configures the value, in seconds, of the holdtime field of the router advertisement sent from this interface.
ip irdp maxadvertinterval	Configures the maximum time, in seconds, allowed between sending router advertisements from the interface.
ip irdp minadvertinterval	Configures the minimum time, in seconds, allowed between sending router advertisements from the interface.
ip irdp preference	Configures the preference of the address as a default router address relative to other router addresses on the same subnet.

Router Discovery Status

Use the **Router Discovery Status** page to display Router Discovery data for each port.

To display the page, click **Routing** → **Router Discovery** → **Status** in the tree view.

Figure 9-34. Router Discovery Status

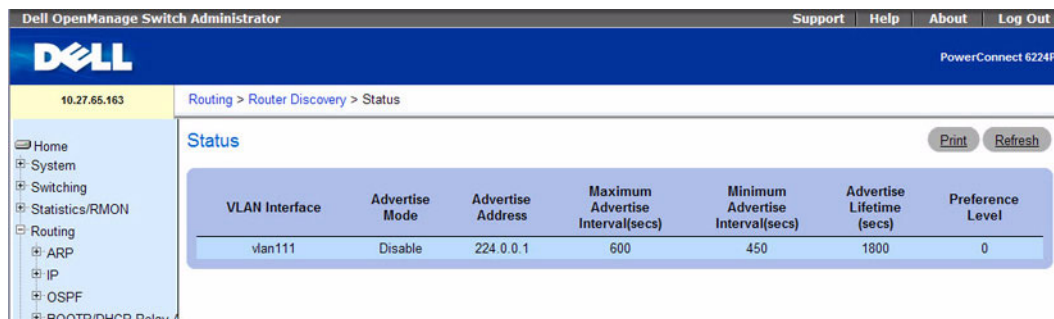

VLAN Interface	Advertise Mode	Advertise Address	Maximum Advertise Interval(secs)	Minimum Advertise Interval(secs)	Advertise Lifetime (secs)	Preference Level
vlan111	Disable	224.0.0.1	600	450	1800	0

The **Router Discovery Status** page displays the following fields:

- **Interface** — The router interface for which data is displayed.

- **Advertise Mode** — The values are Enable or Disable. Enable denotes that Router Discovery is enabled on that interface.
- **Advertise Address** — The IP Address used to advertise the router.
- **Maximum Advertise Interval (secs)** — The maximum time (in seconds) allowed between router advertisements sent from the interface.
- **Minimum Advertise Interval (secs)** — The minimum time (in seconds) allowed between router advertisements sent from the interface.
- **Advertise Lifetime (secs)** — The value (in seconds) used as the lifetime field in router advertisements sent from the interface. This is the maximum length of time that the advertised addresses are to be considered as valid router addresses by hosts.
- **Preference Level** — The preference level of the router as a default router relative to other routers on the same subnet. Higher numbered addresses are preferred.

Displaying Router Discovery Status Using CLI Commands

For information about the CLI command that performs this function, see the following chapter in the *CLI Reference Guide*:

- Router Discovery Protocol Commands

The following table summarizes the equivalent CLI commands for this feature.

Table 9-31. Router Discovery Status Command

CLI Command	Description
show ip irdp	Displays the router discovery information for all interfaces, or for a specified interface.

Router

The **Router** menu page contains links to web pages that configure and display route tables. To display this page, click **Routing** → **Router** in the tree view. Following are the web pages accessible from this menu page:

- Route Table
- Best Routes Table
- Route Entry Configuration
- Configured Routes
- Route Preferences Configuration

Route Table

Use the **Router Route Table** page to display the route table configuration.

To display the page, click **Routing** → **Router** → **Route Table** in the tree view.

Figure 9-35. Router Route Table

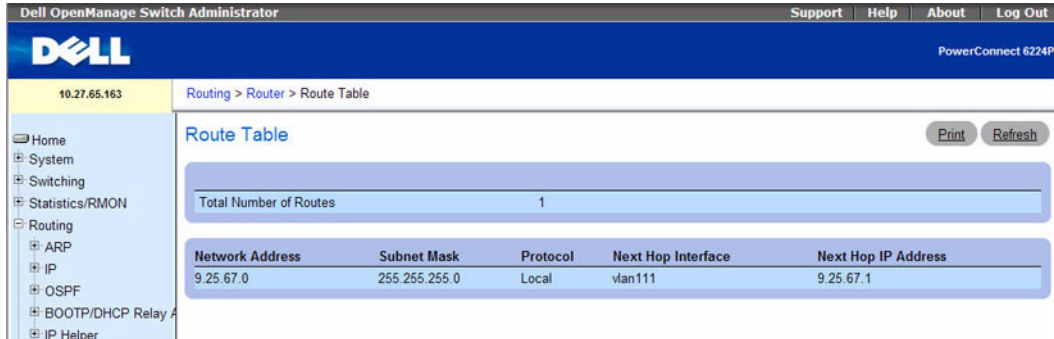

The **Router Route Table** page displays the following fields:

- **Total Number of Routes** — The total number of routes in the route table.
- **Network Address** — The IP route prefix for the destination.
- **Subnet Mask** — Also referred to as the subnet/network mask, this indicates the portion of the IP interface address that identifies the attached network.
- **Protocol** — This field tells which protocol created the specified route. The possibilities are one of the following:
 - Local
 - Static
 - Default
 - OSPF Intra
 - OSPF Inter
 - OSPF Type-1
 - OSPF Type-2
 - RIP
- **Next Hop Interface** — The outgoing router interface to use when forwarding traffic to the destination.
- **Next Hop IP Address** — The outgoing router IP address to use when forwarding traffic to the next router (if any) in the path towards the destination. The next router is always one of the adjacent neighbors or the IP address of the local interface for a directly attached network.

Displaying the Router Route Table Using CLI Commands

For information about the CLI command that performs this function, see the following chapter in the *CLI Reference Guide*:

- IP Routing Commands

The following table summarizes the equivalent CLI commands for this feature.

Table 9-32. Router Route Table Commands

CLI Command	Description
show ip route	Displays the routing table.
show ip route summary	Shows the number of all routes, including best and non-best routes.

Best Routes Table

Use the **Router Best Routes Table** page to display the best routes from the routing table.

To display the page, click **Routing** → **Router** → **Best Routes Table** in the tree view.

Figure 9-36. Router Best Routes Table

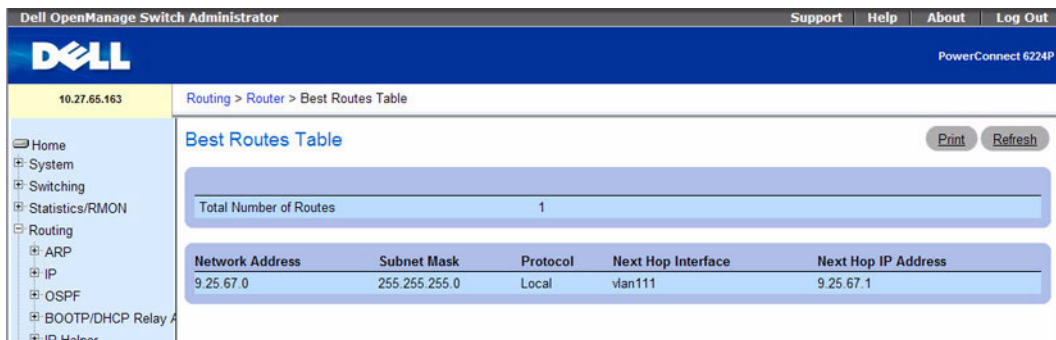

The **Router Best Routes Table** page displays the following fields:

- **Total Number of Routes** — The total number of routes in the route table.
- **Network Address** — The IP route prefix for the destination.
- **Subnet Mask** — Also referred to as the subnet/network mask, this indicates the portion of the IP interface address that identifies the attached network.
- **Protocol** — This field tells which protocol created the specified route. The possibilities are one of the following:
 - Local
 - Static
 - Default
 - OSPF Intra
 - OSPF Inter

- OSPF Type-1
- OSPF Type-2
- RIP
- **Next Hop Interface** — The outgoing router interface to use when forwarding traffic to the destination.
- **Next Hop IP Address** — The outgoing router IP address to use when forwarding traffic to the next router (if any) in the path towards the destination. The next router is always one of the adjacent neighbors or the IP address of the local interface for a directly attached network.

Displaying the Best Routes Table Using CLI Commands

For information about the CLI command that performs this function, see the following chapter in the *CLI Reference Guide*:

- IP Routing Commands

The following table summarizes the equivalent CLI commands for this feature.

Table 9-33. Best Routes Table Command

CLI Command	Description
show ip route preferences	Displays detailed information about the route preferences.

Route Entry Configuration

Use the **Router Route Entry Configuration** page to add new and configure router routes.

To display the page, click **Routing** → **Router** → **Route Entry Configuration** in the tree view.

Figure 9-37. Router Route Entry Configuration

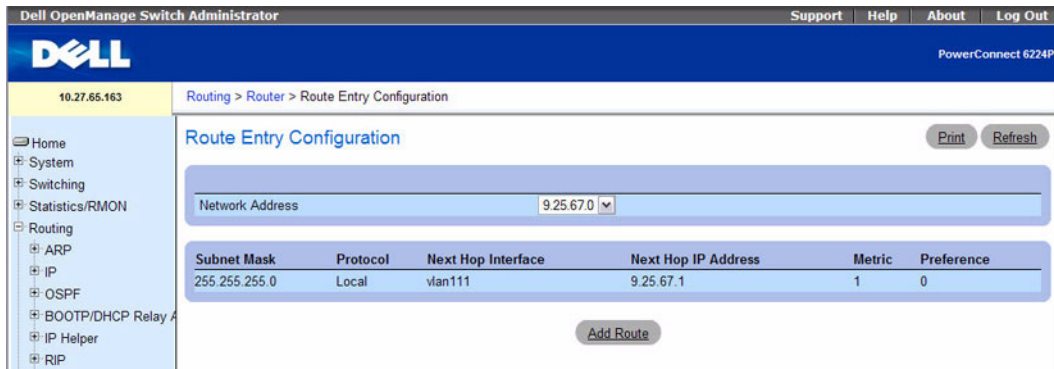

The **Router Route Entry Configuration** page contains the following fields:

- **Network Address** — Specify the IP route prefix for the destination from the drop-down menu. In order to create a route, a valid routing interface must exist and the next hop IP Address must be on the same network as the routing interface. Routing interfaces are created on the **IP Interface Configuration** page. Valid next hop IP Addresses can be viewed on the **Route Table** page.
- **Subnet Mask** — Also referred to as the subnet/network mask, this indicates the portion of the IP interface address that identifies the attached network.
- **Protocol** — This field tells which protocol created the specified route. Possible values are:
 - Local
 - Static
 - Default
 - OSPF Intra
 - OSPF Inter
 - OSPF Type-1
 - OSPF Type-2
 - RIP
- **Next Hop Interface** — The outgoing router interface to use when forwarding traffic to the destination.
- **Next Hop IP Address** — The outgoing router IP address to use when forwarding traffic to the next router (if any) in the path towards the destination. The next router is always one of the adjacent neighbors or the IP address of the local interface for a directly attached network. When creating a route, the next hop IP must be on the same network as the routing interface. Valid next hop IP Addresses can be seen on the 'Route Table' page.
- **Metric** — Administrative cost of the path to the destination. If no value is entered, default is 1. The range is 0–255. This field is present only when creating a static route.
- **Preference** — Specifies a preference value for the configured next hop.

Adding a Router Route

1. Open the **Router Route Entry Configuration** page.
2. Click **Add Route**.

The screen refreshes and the **Router Route Entry Configuration** page displays new fields as shown in Figure 9-38.

Figure 9-38. Add Route - Default Route Type

The screenshot shows a web form titled "Router Route Entry Configuration" with "Print" and "Refresh" buttons in the top right. The form has a light blue background and contains the following fields:

Route Type	Default
Next Hop IP Address	<input type="text"/>

At the bottom of the form are "Cancel" and "Apply Changes" buttons.

3. Next to **Route Type**, use the drop-down box to add a **Default** route or a **Static** route. If you select **Static**, the page refreshes and new fields appear, as Figure 9-39 shows.

Default — Enter the default gateway address in the **Next Hop IP Address** field.

Static — Enter values for **Network Address**, **Subnet Mask**, **Next Hop IP Address**, and **Preference**.

Figure 9-39. Route Entry Configuration - Add Static Route Type

The screenshot shows the same "Router Route Entry Configuration" form, but with "Route Type" set to "Static". The form now includes additional fields:

Route Type	Static
Network Address	<input type="text"/>
Subnet Mask	<input type="text"/>
Next Hop IP Address	<input type="text"/>
Preference	1 (1 to 255)

At the bottom of the form are "Cancel" and "Apply Changes" buttons.

4. Click **Apply Changes**.

The new route is added, and you are redirected to the Configured Routes page.

Adding a Router Route Using CLI Commands

For information about the CLI command that performs this function, see the following chapter in the *CLI Reference Guide*:

- IP Routing Commands

The following table summarizes the equivalent CLI commands for this feature.

Table 9-34. Router Route Configuration Commands

CLI Command	Description
ip route	Configures a static route. Use the no form of the command to delete the static route.
ip route default	Configures the default route. Use the no form of the command to delete the default route.

Configured Routes

Use the **Configured Routes** page to display the routes that have been configured.

To display the page, click **Routing** → **Router** → **Configured Routes** in the tree view.

Figure 9-40. Configured Routes

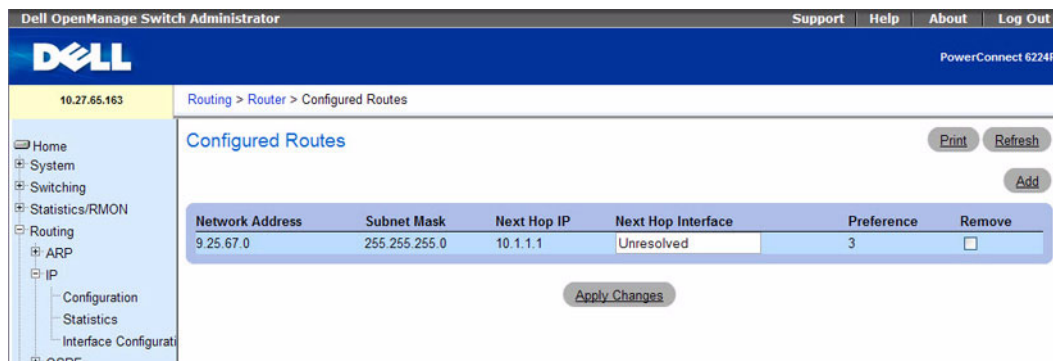

The **Configured Routes** page displays the following fields:

- **Network Address** — The IP route prefix for the destination.
- **Subnet Mask** — Also referred to as the subnet/network mask, this indicates the portion of the IP interface address that identifies the attached network.
- **Next Hop IP** — The outgoing router interface to use when forwarding traffic to the destination.
- **Preference** — Displays the preferences configured for the added routes.
- **Remove** — Use this check box to remove a configured route.

Adding a Router Route

1. Open the **Configured Routes** page.
2. Click **Add**.

The **Router Route Entry Configuration** page displays, as Figure 9-38 shows.

3. Next to **Route Type**, use the drop-down box to add a **Default** route or a **Static** route.

Default — Enter the default gateway address in the **Next Hop IP Address** field. Figure 9-38 shows the fields that display when the **Route Type** value is **Default**.

Static — Enter values for **Network Address**, **Subnet Mask**, **Next Hop IP Address**, and **Preference**. Figure 9-39 shows the fields that display when the **Route Type** value is **Static**.

4. Click **Apply Changes**.

The new route is added, and you are returned to the **Configured Routes** page.

Displaying Configured Routes Using CLI Commands

For information about the CLI command that performs this function, see the following chapter in the *CLI Reference Guide*:

- IP Routing Commands

The following table summarizes the equivalent CLI commands for this feature.

Table 9-35. IP Configured Routes Command

CLI Command	Description
show ip route	Displays the routing table.

Route Preferences Configuration

Use the **Router Route Preferences Configuration** page to configure the default preference for each protocol (for example 60 for static routes). These values are arbitrary values that range from 1 to 255, and are independent of route metrics. Most routing protocols use a route metric to determine the shortest path known to the protocol, independent of any other protocol.

The best route to a destination is chosen by selecting the route with the lowest preference value. When there are multiple routes to a destination, the preference values are used to determine the preferred route. If there is still a tie, the route with the best route metric is chosen. To avoid problems with mismatched metrics (i.e. RIP and OSPF metrics are not directly comparable), you must configure different preference values for each of the protocols.

Static Reject Routes

A static reject route is a static route to discard the packets to a particular destination, thereby forcing a black-hole routing behavior for a particular set of IP prefixes. Static reject routes can help prevent a routing loop in the network if a default route is configured on a router. Static reject routes also help protect against a DOS attack on a router with unwanted destination addresses.

 **NOTE:** Static reject routes are not redistributed by OSPF or RIP.

You can select **Static Reject** as a route type from the **Route Type** field on the following pages under the **Routing** → **Router** menu:

- Route Entry Configuration
- Configured Routes

NOTE: For a static reject route, the next hop interface value is Null0. Packets to the network address specified in static reject routes are intentionally dropped.

To display the page, click **Routing** → **Router** → **Route Preferences Configuration** in the tree view.

Figure 9-41. Router Route Preferences Configuration

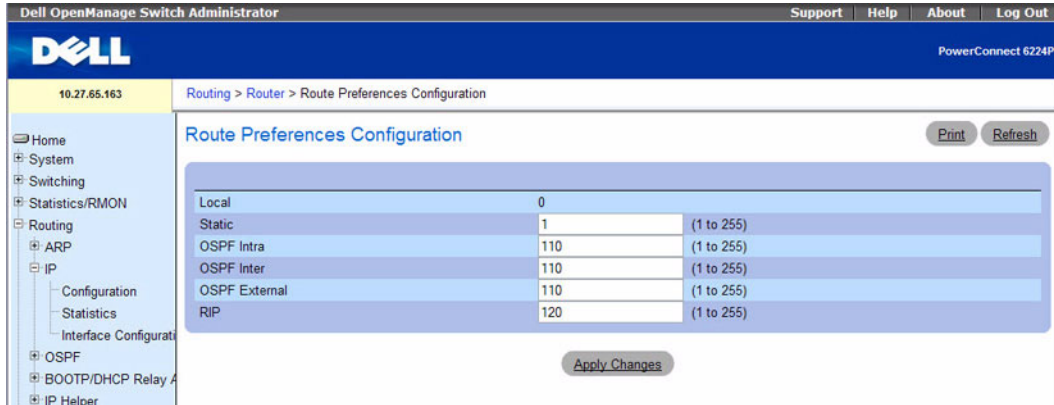

The **Router Route Preferences Configuration** page contains the following fields:

- **Local** — This field displays the local route preference value.
- **Static** — The static route preference value in the router. The default value is 1. The range is 1 to 255.
- **OSPF Intra** — The OSPF intra route preference value in the router. The default value is 110.
- **OSPF Inter** — The OSPF inter route preference value in the router. The default value is 110.
- **OSPF External** — The OSPF External route preference value in the router (OSPF External are OSPF Type-1 and OSPF Type-2 routes). The default value is 110.
- **RIP** — The RIP route preference value in the router. The default value is 120.

Configuring Route Preferences

1. Open the **Route Preferences Configuration** page.
2. Define the applicable fields on this page
3. Click **Apply Changes**.

The route preferences are configured, and the device is updated.

Configuring Route Preferences Using CLI Command

For information about the CLI command that performs this function, see the following chapter in the *CLI Reference Guide*:

- OSPF Commands

The following table summarizes the equivalent CLI commands for this feature.

Table 9-36. Route Preference Commands

CLI Command	Description
ip route	Configures a static reject route.
ip route distance	Sets the default distance (preference) for static routes.

VLAN Routing

You can configure PowerConnect 6200 Series software with some VLANs that support routing. You can also configure the software to allow traffic on a VLAN to be treated as if the VLAN were a router port.

When a port is enabled for bridging (default) rather than routing, all normal bridge processing is performed for an inbound packet, which is then associated with a VLAN. Its MAC Destination Address (MAC DA) and VLAN ID are used to search the MAC address table. If routing is enabled for the VLAN, and the MAC DA of an inbound unicast packet is that of the internal bridge-router interface, the packet is routed. An inbound multicast packet is forwarded to all ports in the VLAN, plus the internal bridge-router interface, if it was received on a routed VLAN.

Since a port can be configured to belong to more than one VLAN, VLAN routing might be enabled for all of the VLANs on the port or for only some of the VLANs on the port. VLAN Routing can be used to allow more than one physical port to reside on the same subnet. It could also be used when a VLAN spans multiple physical networks, or when additional segmentation or security is required. This section shows how to configure the PowerConnect 6200 Series software to support VLAN routing. A port can be either a VLAN port or a router port, but not both. However, a VLAN port may be part of a VLAN that is itself a router port.

The **VLAN Routing** menu page contains a link to a web page that displays VLAN Routing parameters and data. To display this page, click **Routing** → **VLAN Routing** in the tree view. The following web page is accessible from this menu page:

- VLAN Routing Summary

VLAN Routing Summary

Use the **VLAN Routing Summary** page to display the VLAN routing summary.

To display the page, click **Routing** → **VLAN Routing** → **Summary** in the tree view.

Figure 9-42. VLAN Routing Summary

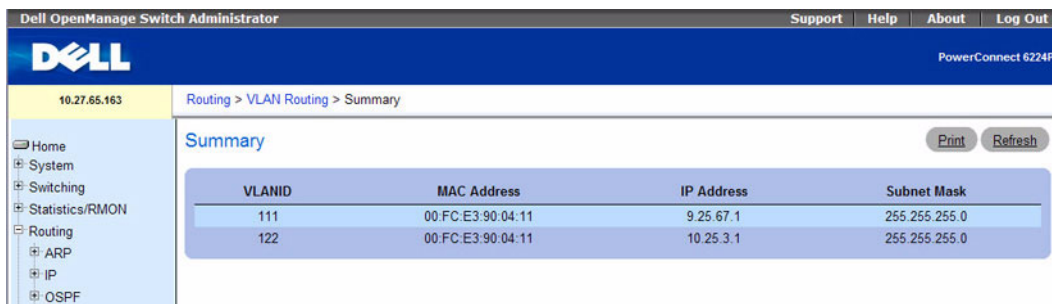

The VLAN Routing Summary page displays the following fields:

- **VLAN ID** — The ID of the VLAN whose data is displayed in the current table row.
- **MAC Address** — The MAC Address assigned to the VLAN Routing Interface.
- **IP Address** — The configured IP address of the VLAN Routing Interface.



NOTE: If a VLAN is created and the IP address is not configured, the web page by default shows an IP address of 0.0.0.0. To configure the IP address, go to the **Routing → IP → Interface Configuration** page. See "IP Interface Configuration" on page 512.

- **Subnet Mask** — The configured subnet mask of the VLAN Routing Interface. This is 0.0.0.0 when the VLAN Routing Interface is first configured and must be entered on the **Routing → IP → Interface Configuration** page.

Displaying the VLAN Routing Summary Using CLI Commands

For information about the CLI commands that perform this function, see the following chapters in the *CLI Reference Guide*:

- IP Addressing Commands
- Virtual LAN Routing Commands

The following table summarizes the equivalent CLI commands for this feature.

Table 9-37. VLAN Routing Summary Commands

CLI Command	Description
interface vlan	Enters the interface configuration (VLAN) mode.
interface range vlan	Enters the interface configuration mode to configure multiple VLANs.
name	Configures a name to a VLAN.
show ip vlan	Displays the VLAN routing information for all VLANs with routing enabled.
vlan routing	Enables routing on a VLAN.

VRRP

The Virtual Router Redundancy (VRRP) protocol is designed to handle default router failures by providing a scheme to dynamically elect a backup router. The driving force was to minimize “black hole” periods due to the failure of the default gateway router during which all traffic directed towards it is lost until the failure is detected. Though static configuration of default routes is popular, such an approach is susceptible to a single point of failure when the default router fails. VRRP advocates the concept of a “virtual router” associated with one or more IP Addresses that serve as default gateways. In the event that the VRRP Router controlling these IP Addresses (formally known as the Master) fails, the group of IP Addresses and the default forwarding role is taken over by a Backup VRRP Router.

The VRRP Router Configuration feature enables interface and route tracking. Use VRRP tracking to ensure the best VRRP router is Master for the group.

VRRP interface tracking monitors a specific interface IP state within the router. Depending on the state of the tracked interface, the feature can alter the VRRP priority level of a virtual router for a VRRP group. An exception to the priority level change is that if the VRRP group is the IP address owner, its priority is fixed at 255 and cannot be reduced through the tracking process.

VRRP route tracking monitors the reachability of an IP route. A tracked route is considered up when a routing table entry exists for the route and the route is accessible. To configure route tracking, make VRRP a best route client of RTO. When a tracked route is added or deleted, change the priority.

The **VRRP** menu page contains links to web pages that configure and display parameters and data. To display this page, click **Routing** → **VRRP** in the tree view. Following are the web pages accessible from this menu page:

- VRRP Configuration
- VRRP Router Configuration
- VRRP Virtual Router Status
- VRRP Virtual Router Statistics

VRRP Configuration

Use the VRRP Configuration page to enable or disable the administrative status of a virtual router. To display the page, click **Routing** → **VRRP** → **Router Configuration** in the tree view.

Figure 9-43. VRRP Configuration

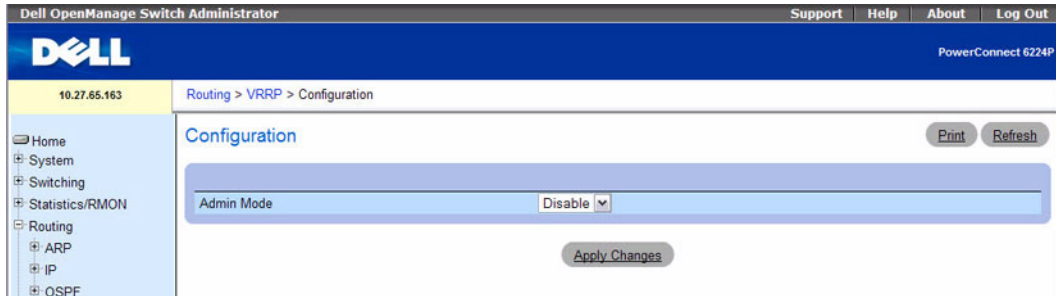

The VRRP Configuration page contains the following field:

- **Admin Mode** — Select **Enable** from the drop-down menu to administratively enable VRRP on the system.

Configuring VRRP Global Settings Using CLI Commands

For information about the CLI commands that perform this function, see the following chapters in the *CLI Reference Guide*:

- Virtual Router Redundancy Protocol Commands

The following table summarizes the equivalent CLI commands for this feature.

Table 9-38. VRRP Global Commands

CLI Command	Description
ip vrrp	Enables the administrative mode of VRRP for the router.
show ip vrrp	Displays whether VRRP functionality is enabled or disabled on the switch.

VRRP Router Configuration

Use the VRRP Configuration page to configure a virtual router.

To display the page, click **Routing** → **VRRP** → **Router Configuration** in the tree view.

Figure 9-44. VRRP Router Configuration

The screenshot shows the Dell OpenManage Switch Administrator interface. The top navigation bar includes 'Support', 'Help', 'About', and 'Log Out'. The breadcrumb trail is 'Routing > VRRP > Router Configuration'. The left sidebar shows a tree view with 'VRRP > Router Configuration' selected. The main content area is titled 'Router Configuration' and contains a form with the following fields:

VRID and Interface	Create	
VRID		(1 to 255)
Interface	vlan111	
Pre-empt Mode	Enable	
Configured Priority	100	(1 to 255)
Priority		
Advertisement Interval	1	(1 to 255 seconds)
Interface IP Address		
IP Address		(X.X.X.X)
Authentication Type	0 - None	
Authentication Data		(1 to 8 characters)
Status	Inactive	

Buttons: Print, Refresh, Create

The VRRP Router Configuration page contains the following fields:

- **VRID and Interface** — Select **Create** from the drop-down menu to configure a new Virtual Router, or select one of the existing Virtual Routers, listed by interface number and VRID.
- **VRID** — This field is only configurable if you are creating new Virtual Router, in which case enter the VRID in the range 1 to 255.
- **Interface** — This field is only configurable if you are creating new Virtual Router, in which case select the interface for the new Virtual Router from the drop-down menu.
- **Pre-empt Mode** — Select **Enable** or **Disable** from the drop-down menu. If you select **Enable**, a backup router preempts the master router if it has a priority greater than the master virtual router's priority provided the master is not the owner of the virtual router IP address. The default is **Enable**.
- **Configured Priority** — Enter the priority value to be used by the VRRP router in the election for the master virtual router. If the Virtual IP Address is the same as the interface IP Address, the priority gets set to 255 no matter what you enter. If you enter a priority of 255 when the Virtual and interface IP Addresses are not the same, the priority gets set to the default value of 100.

- **Priority** — The operational priority of the VRRP router, which is relative to the configured priority and depends on the priority decrements configured through tracking process. The priority and configured priority are the same unless a tracked event (for example a tracked interface is down) has occurred to change the value.
- **Advertisement Interval** — Enter the time, in seconds, between the transmission of advertisement packets by this virtual router. Enter a number between 1 and 255. The default value is 1 second.
- **Interface IP Address** — Indicates the IP Address associated with the selected interface.
- **IP Address** — Enter the IP Address associated with the Virtual Router. The default is 0.0.0.0, which you must change prior to pressing **Create**.
- **Authentication Type** — Select the type of Authentication for the Virtual Router from the drop-down menu. The default is None. The choices are:
 - **0-None** — No authentication is performed.
 - **1-Simple** — Authentication is performed using a text password.
- **Authentication Data** — If you selected simple authentication, enter the password.
- **Status** — Select active or inactive from the drop-down menu to start or stop the operation of the Virtual Router. The default is inactive.

Creating a new Virtual Router

1. Open the **Virtual Router Configuration** page.
2. Select **Create** from the VRID and Interface drop-down menu.
3. Specify the VRID and the interface for the new virtual router.
4. Define the remaining fields as needed.
5. Click **Apply Changes**.

The new virtual router is saved, and the device is updated.

The configuration is saved, and the device is updated.

Configuring a Secondary IP Address

If you wish to configure a Secondary VRRP address, first configure one IP address (the primary address) for the VR. You can then add multiple Secondary addresses to that interface.

1. Open the **Router Configuration** page. Because you first configured the primary address, now the **Secondary IP Address** button appears at the bottom of the page.
2. Click the **Secondary IP Address** button.

The **Virtual Router Secondary Address** page displays.

Figure 9-45. Virtual Router Secondary Address

Field	Value
Interface	vlan10
Virtual Router ID	12
Primary IP Address	0.0.0.0
Secondary Address	Create ▾
IP Address	<input type="text"/>

[Apply Changes](#) [Back](#)

3. In the **Secondary Address** field, select **Create** to add a new secondary IP address, or select an existing secondary IP address to modify.
4. In the **IP Address** field, enter the secondary IP address.
5. Click **Apply Changes**.

Configuring VRRP Interface Tracking

1. Open the **VRRP Router Configuration** page.
2. Click **Track Interface**.

The **VRRP Interface Tracking Configuration** page displays. From this page, you can add a new interface to track or remove a tracked interface.

Figure 9-46. VRRP Interface Tracking Configuration

Field	Value
Interface	vlan10
Virtual Router ID	12

Tracking Interface	Priority Decrement	Interface State	Remove
--------------------	--------------------	-----------------	--------

[Apply Changes](#) [Back](#)

3. Click **Add**.
The page refreshes, and the configuration fields appear.

Figure 9-47. Add VRRP Interface Tracking

Interface	vlan10		
Virtual Router ID	12		
Track Interface	1/g1		
Priority Decrement	10 (1 to 254)		

Apply Changes Back

4. Complete the fields as necessary.

The Add VRRP Interface Tracking page contains the following fields.

- **Interface** — The interface associated with the Virtual Router ID.
- **Virtual Router ID** — The Virtual Router ID.
- **Track Interface** — Select an interface for the VRRP router to track.
- **Priority Decrement** — When a tracked interface goes down, the priority decrement specifies the amount that the router priority will be decreased. The valid range is 1 to 254. The default value is 10.

5. Click **Apply Changes** to update the switch.

Configuring VRRP Route Tracking

1. Open the **VRRP Router Configuration** page.
2. Click **Track Route**.

The **VRRP Route Tracking Configuration** page displays. From this page, you can add a new route to track or remove a tracked route.

Figure 9-48. VRRP Route Tracking Configuration

Interface	vlan10		
Virtual Router ID	12		

Tracking Route Pfx	Tracking Route PfxLen	Priority Decrement	Reachable	Remove
--------------------	-----------------------	--------------------	-----------	--------

Apply Changes Back

3. To add a VRRP tracking route, click **Add**.
The page refreshes, and the configuration fields appear.

Figure 9-49. Add VRRP Route Tracking

VRRP Route Tracking	
Interface	vlan10
Virtual Router ID	12
Track Route pfx	0.0.0.0
Track Route pfxlen	0
Priority Decrement	10 (1 to 254)

Apply Changes Back

4. Complete the fields as necessary.

The **Add VRRP Route Tracking** page contains the following fields.

- **Interface** — The interface associated with the Virtual Router ID.
- **Virtual Router ID** — The Virtual Router ID.
- **Track Route pfx**— Enter the destination prefix for the route to be tracked. Specify the prefix in dotted decimal format, for example 192.168.10.0
- **Track Route pfxlen** — Enter the prefix length for the route to track.
- **Priority Decrement** — When a tracked route becomes unreachable, the priority decrement specifies the amount that the router priority will be decreased. The valid range is 1 to 254. The default value is 10.

5. Click **Apply Changes** to update the switch.

Configuring a Virtual Router Using CLI Commands

For information about the CLI commands that perform this function, see the following chapter in the *CLI Reference Guide*:

- Virtual Router Redundancy Protocol Commands

The following table summarizes the equivalent CLI commands for this feature.

Table 9-39. VRRP Configuration Commands

CLI Command	Description
ip vrrp authentication	Sets the authorization details value for the virtual router configured on a specified interface.
ip vrrp ip	Sets the virtual router IP address value for an interface.
ip vrrp mode	Enables the virtual router configured on an interface. Enabling the status field starts a virtual router.
ip vrrp preempt	Sets the preemption mode value for the virtual router configured on a specified interface.
ip vrrp priority	Sets the priority value for the virtual router configured on a specified interface.
ip vrrp timers advertise	Sets the frequency, in seconds, that an interface on the specified virtual router sends a virtual router advertisement.
ip vrrp track interface	Alters the priority of the VRRP router based on the availability of its interfaces.
ip vrrp track ip route	Tracks route reachability.
vrrp track interface	Alters the priority of the VRRP router based on the availability of its interfaces.
vrrp track ip route	Tracks route reachability.

VRRP Virtual Router Status

Use the Virtual Router Status page to display virtual router status.

To display the page, click **Routing** → **VRRP** → **Virtual Router Status** in the tree view.

Figure 9-50. Virtual Router Status

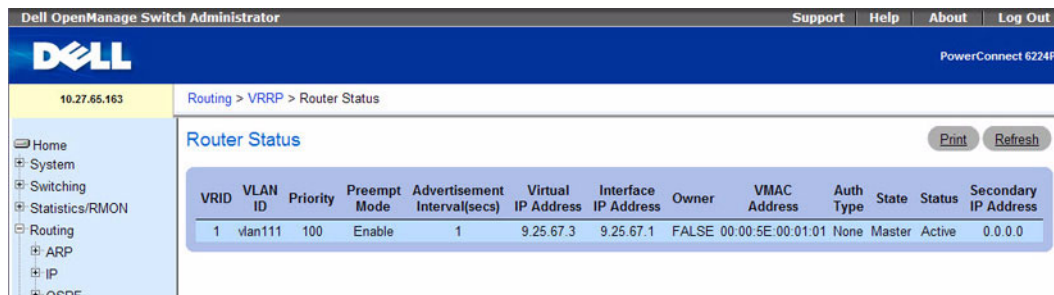

The **Virtual Router Status** page displays the following fields:

- **VRID** — Virtual Router Identifier.

- **VLANID** - Indicates the interface associate with the VRID.
- **Priority** — The priority value used by the VRRP router in the election for the master virtual router.
- **Pre-empt Mode**
 - **Enable** — If the Virtual Router is a backup router it preempts the master router if it has a priority greater than the master virtual router's priority provided the master is not the owner of the virtual router IP address.
 - **Disable** — If the Virtual Router is a backup router it does not preempt the master router even if its priority is greater.
- **Advertisement Interval (secs)** — The time, in seconds, between the transmission of advertisement packets by this virtual router.
- **Virtual IP Address** — The IP Address associated with the Virtual Router.
- **Interface IP Address** — The actual IP Address associated with the interface used by the Virtual Router.
- **Owner** — Set to True if the Virtual IP Address and the Interface IP Address are the same, otherwise set to False. If this parameter is set to True, the Virtual Router is the owner of the Virtual IP Address, and always wins an election for master router when it is active.
- **VMAC Address** — The virtual MAC Address associated with the Virtual Router, composed of a 24-bit organizationally unique identifier, the 16-bit constant identifying the VRRP address block and the 8-bit VRID. The Virtual MAC address is 00:00:5e:00:01:XX where XX is the VRID.
- **Auth Type** — The type of authentication in use for the Virtual Router
 - **None** — Specifies that the authentication type is none.
 - **Simple** — Specifies that the authentication type is a simple text password.
- **State** — The current state of the Virtual Router:
 - Initialize
 - Master
 - Backup
- **Status** — The current status of the Virtual Router:
 - Inactive
 - Active
- **Secondary IP Address** — A secondary VRRP address configured for the primary VRRP.

Displaying Virtual Router Status Using CLI Commands

For information about the CLI commands that perform this function, see the following chapter in the *CLI Reference Guide*:

- Virtual Router Redundancy Protocol Commands

The following table summarizes the equivalent CLI commands for this feature.

Table 9-40. Virtual Router Status Commands

CLI Command	Description
show ip vrrp interface	Displays all configuration information and VRRP router statistics of a virtual router configured on a specific interface.
show ip vrrp interface brief	Displays information about each virtual router configured on the switch.

VRRP Virtual Router Statistics

Use the Virtual Router Statistics page to display statistics for a specified virtual router. To display the page, click **Routing** → **VRRP** → **Virtual Router Statistics** in the tree view.

Figure 9-51. Virtual Router Statistics

The screenshot shows the Dell OpenManage Switch Administrator interface. The breadcrumb navigation is **Routing > VRRP > Router Statistics**. The left sidebar shows a tree view with **Router Statistics** selected under **VRRP**. The main content area displays the **Router Statistics** page with a table of metrics. The table has a light blue background and includes the following data:

Router Checksum Errors	0
Router Version Errors	0
Router VRID Errors	0
VLAN ID	vlan111
VRID	1
Up Time	28 days 13 h:29 m:10 s
State Transitioned To Master	1
Advertisement Received	0
Advertisement Interval Errors	0
Authentication Failure	0
IP TTL Errors	0
Zero Priority Packets Received	0
Zero Priority Packets Sent	0
Invalid Type Packets Received	0
Address List Errors	0
Invalid Authentication Type	0
Authentication Type Mismatch	0
Packet Length Errors	0

The **Virtual Router Statistics** page contains the fields listed below. Many of the fields display only when there is a valid VRRP configuration.

- **Router Checksum Errors** — The total number of VRRP packets received with an invalid VRRP checksum value.
- **Router Version Errors** — The total number of VRRP packets received with an unknown or unsupported version number.
- **Router VRID Errors** — The total number of VRRP packets received with an invalid VRID for this virtual router.
- **VRID and VLAN ID** — Select the existing Virtual Router, listed by interface number and VRID, for which you want to display statistical information.
- **VRID** — the VRID for the selected Virtual Router.
- **VLAN ID** — The interface for the selected Virtual Router.
- **Up Time** — The time, in days, hours, minutes and seconds, that has elapsed since the virtual router transitioned to the initialized state.

- **State Transitioned to Master** — The total number of times that this virtual router's state has transitioned to Master.
- **Advertisement Received** — The total number of VRRP advertisements received by this virtual router.
- **Advertisement Interval Errors** — The total number of VRRP advertisement packets received for which the advertisement interval was different than the one configured for the local virtual router.
- **Authentication Failure** — The total number of VRRP packets received that did not pass the authentication check.
- **IP TTL Errors** — The total number of VRRP packets received by the virtual router with IP TTL (Time-To-Live) not equal to 255.
- **Zero Priority Packets Received** — The total number of VRRP packets received by the virtual router with a priority of 0.
- **Zero Priority Packets Sent** — The total number of VRRP packets sent by the virtual router with a priority of 0.
- **Invalid Type Packets Received** — The number of VRRP packets received by the virtual router with an invalid value in the Type field.
- **Address List Errors** — The total number of packets received for which the address list does not match the locally configured list for the virtual router.
- **Invalid Authentication Type** — The total number of packets received with an unknown authentication type.
- **Authentication Type Mismatch** — The total number of packets received with an authentication type different to the locally configured authentication method.
- **Packet Length Errors** — The total number of packets received with a packet length less than the length of the VRRP header.

Displaying Virtual Router Statistics

1. Open the **Virtual Router Statistics** page.
2. Select the virtual router for which you want to display statistical information from the **VRID** and **VLANID** field. This information displays only if there is a valid VRRP configuration.

Displaying Virtual Router Statistics Using CLI Commands

For information about the CLI command that performs this function, see the following chapter in the *CLI Reference Guide*:

- Virtual Router Redundancy Protocol Commands

The following table summarizes the equivalent CLI commands for this feature.

Table 9-41. VRRP Interface Statistics Command

CLI Command	Description
show ip vrrp interface stats	Displays the statistical information about each virtual router configured on the switch.

Tunnels

The PowerConnect 6200 Series switches support the creation, deletion, and management of tunnel interfaces. These are dynamic interfaces that are created and deleted through user-configuration. Each switch also supports the functionality of a 6to4 border router that connects a 6to4 site to a 6to4 domain. It sends and receives tunneled traffic from routers in a 6to4 domain that includes other 6to4 border routers and 6to4 relay routers.

There are two classes of tunnels that facilitate the transition of IPv4 networks to IPv6 networks: configured and automatic. The distinction is that configured tunnels are explicitly configured with a destination or endpoint of the tunnel. Automatic tunnels, in contrast, infer the endpoint of the tunnel from the destination address of packets routed into the tunnel.

The PowerConnect 6200 Series supports point-to-point tunnels. Point-to-point interfaces provide for routing based only on the interface (an explicit next-hop address need not be specified), and allow for the definition of unnumbered interfaces.

The **Tunnels** menu page contains links to web pages that configure and display tunnel parameters and data. To display this page, click **Routing** → **Tunnels** in the tree view. Following are the web pages accessible from this menu page:

- Tunnels Configuration
- Tunnels Summary

Tunnels Configuration

Use the Tunnels Configuration page to create, configure, or delete a tunnel.

To display the page, click **Routing** → **Tunnels** → **Configuration** in the tree view.

Figure 9-52. Tunnels Configuration

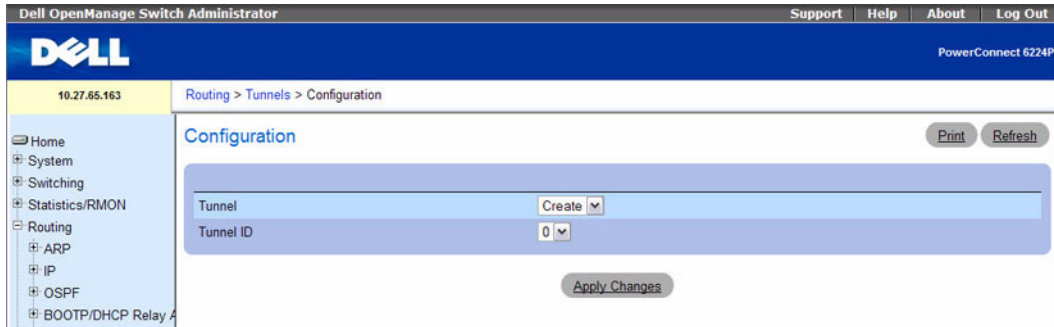

The Tunnels Configuration page contains the following fields:

- **Tunnel** — Use the drop-down menu to select from the list of currently configured tunnel IDs. **Create** is also a valid choice if the maximum number of tunnel interfaces has not been created.
- **Tunnel ID** — When **Create** is chosen from the tunnel selector this list of available tunnel IDs becomes visible. You must select a tunnel ID to associate with the new tunnel and click **Apply Changes** before the remaining fields on the page display.
- **Mode** — Selector for the Tunnel mode, which can be one of the following:
 - **6-in-4-configured** — The 6in4 tunnel mode is configured rather than automatic.
 - **6-to-4** — 6to4 tunnels are automatically formed IPv4 tunnels carrying IPv6 traffic. The automatic tunnel's IPv4 destination address is derived from the 6to4 IPv6 address of the tunnel's nexthop. The switch supports the functionality of a 6to4 border router that connects a 6to4 site to a 6to4 domain. It sends/receives tunneled traffic from routers in a 6to4 domain that includes other 6to4 border routers and 6to4 relay routers.
- **Link Local Only Mode** — Enable IPv6 on this interface using the Link Local address. This option is only configurable prior to specifying an explicit IPv6 address.
- **IPv6 Address** — Select an IPv6 address for the selected Tunnel interface. **Add** is also a valid choice if the maximum number of addresses has not been configured.
- **IPv6 Address** — When **Add** is chosen from the IPv6 Address drop-down menu, this IPv6 address input field becomes visible. The Address must be entered in the format prefix/length. You also have the option to specify the 64-bit extended unique identifier (EUI-64).
- **IPv6 Prefix Length** — Specify the IPv6 prefix length.

- **Source** — Select the desired source, IPv4 Address or Interface. If Address is selected, the source address for this tunnel must be entered in dotted decimal notation. If Interface is selected the source interface for this tunnel must be selected. The address associated with the selected interface is used as the source address.
- **Destination Address** — The IPv4 destination address for this tunnel in dotted decimal notation.

Creating a New Tunnel

1. Open the **Tunnels Configuration** page.
2. Select **Create** from the **Tunnel** drop-down menu.
3. Specify an ID to use in the **Tunnel ID** field.
4. Click **Apply Changes**.
The Tunnel ID field is removed, and the remaining tunnel fields display.

Figure 9-53. Tunnels Configuration - Entry

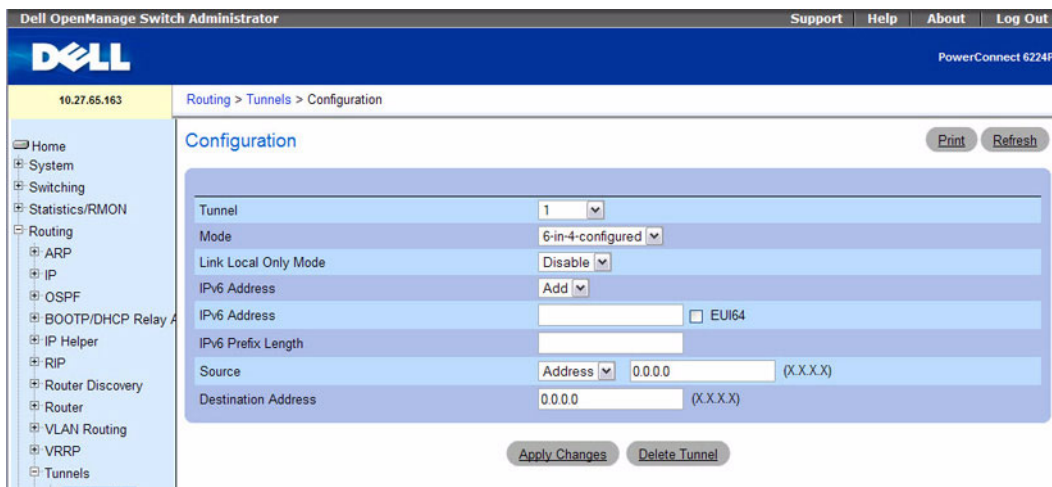

5. Configure the fields as needed.
6. Enter desired values in the remaining fields.
7. Click **Apply Changes**.
The new tunnel is saved, and the device is updated.

Modifying an Existing Tunnel

1. Open the **Tunnels Configuration** page.
2. Specify the tunnel to modify in the **Tunnel** drop-down menu.
3. Change field values as desired in the remaining fields.

4. Click **Apply Changes**.

The new configuration is saved, and the device is updated.

Removing a Tunnel

1. Open the **Tunnels Configuration** page.
2. Specify the tunnel to remove in the **Tunnel** drop-down menu.
3. Click **Delete Tunnel**.

The tunnel is deleted, and the device is updated.

Configuring a Tunnel using CLI Commands

For information about the CLI command that performs this function, see the following chapter in the *CLI Reference Guide*:

- Tunnel Interface Commands

The following table summarizes the equivalent CLI commands for this feature.

Table 9-42. Tunnel Commands

CLI Command	Description
interface tunnel	Enables the interface configuration mode for a tunnel.
tunnel destination	Specifies the destination transport address of the tunnel.
tunnel mode ipv6ip	Specifies the mode of the tunnel.
tunnel source	Specifies the source transport address of the tunnel, either explicitly or by reference to an interface.

Tunnels Summary

Use the **Tunnels Summary** page to display a summary of configured tunnels. To display the page, click **Routing** → **Tunnels** → **Summary** in the tree view.

Figure 9-54. Tunnels Summary

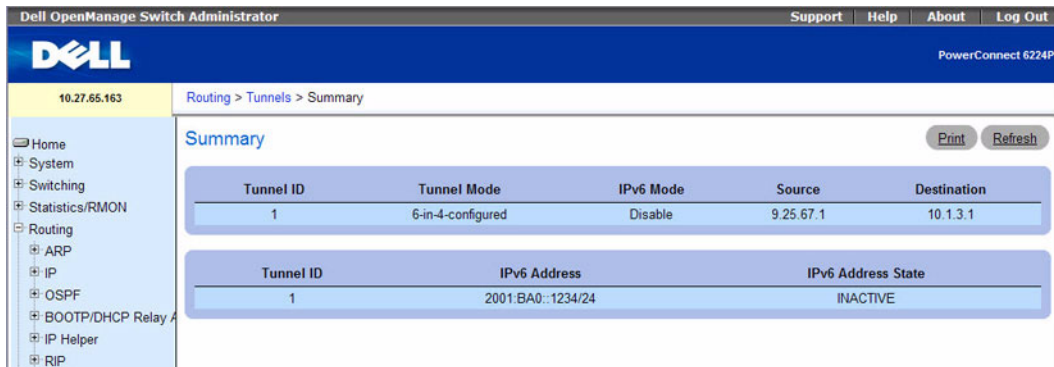

The **Tunnels Summary** page contains the following fields:

- **Tunnel ID** — The Tunnel ID.
- **Tunnel Mode** — The corresponding mode of the Tunnel.
- **IPv6 Mode** — Shows whether IPv6 is enabled on the tunnel.
- **Source** — The corresponding Tunnel Source Address. In the case where an interface has been configured both the interface and the address are displayed. If the source interface has no address configured then nothing is displayed in place of the address.
- **Destination** — The corresponding Tunnel Destination Address.
- **Tunnel ID** — The Tunnel ID.
- **IPv6 Address** — The IPv6 Address(es) of the Tunnel.

IPv6 Address State — Shows whether the address is active.

Displaying Tunnels Summary Using CLI Commands

For information about the CLI command that performs this function, see the following chapter in the *CLI Reference Guide*:

- Tunnel Interface Commands

The following table summarizes the equivalent CLI commands for this feature.

Table 9-43. Tunnel Summary Command

CLI Command	Description
show interface tunnel	Displays the parameters related to tunnel such as tunnel mode, tunnel source address and tunnel destination address.

Loopbacks

The PowerConnect 6200 Series provides for the creation, deletion, and management of loopback interfaces. They are dynamic interfaces that are created and deleted through user-configuration. The PowerConnect 6200 Series supports multiple loopback interfaces.

A loopback interface is always expected to be up. As such, it provides a means to configure a stable IP address on the device that may be referred to by other switches. This interface provides the source address for sent packets and can receive both local and remote packets. It is typically used by routing protocols.

The loopback does not behave like the network port on Switching systems. In particular, there are no neighbors on a loopback interface. It is a pseudo-device for assigning local addresses so that the router can be communicated with by this address, which is always up and can receive traffic from any of the existing active interfaces. Thus, given reachability from a remote client, the address of the loopback can be used to communicate with the router through various services such as telnet and SSH. In this way, the address on a loopback behaves identically to any of the local addresses of the router in terms of the processing of incoming packets.

The **Loopbacks** menu page contains links to web pages that configure and display loopback parameters and data. To display this page, click **Routing → Loopbacks** in the tree view. Following are the web pages accessible from this menu page:

- Loopbacks Configuration
- Loopbacks Summary

Loopbacks Configuration

Use the **Loopbacks Configuration** page to create, configure, or remove loopback interfaces. You can also set up or delete a secondary address for a loopback.

To display the page, click **Routing → Loopbacks → Configuration** in the tree view.

Figure 9-55. Loopback Configuration

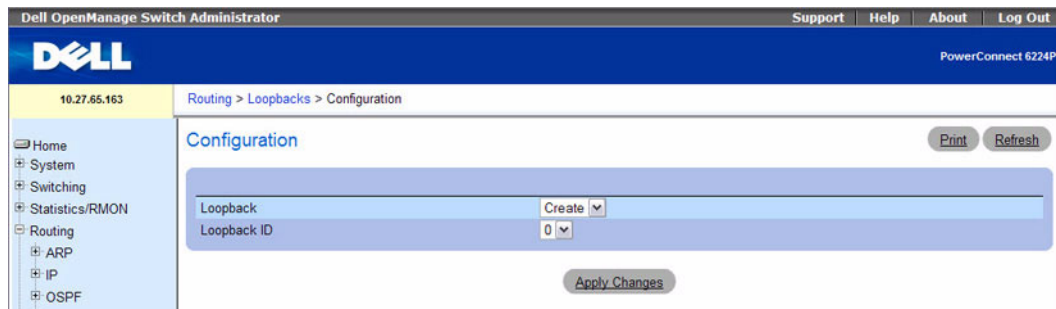

The **Loopbacks Configuration** pages contain the following fields:

- **Loopback** — Use the drop-down menu to select from the list of currently configured loopback interfaces. Create is also a valid choice if the maximum number of loopback interfaces has not been created.
- **Loopback ID** — When Create is selected in the Loopback field, this list of available loopback ID's displays.
- **Protocol** — Select IPv4 or IPv6 to configure the corresponding attributes on the loopback interface. The protocol selected affects the fields that are displayed on this page.
- **Link Local Only Mode** — Enable IPv6 on this interface using the Link Local address. This option only displays when the Protocol specified is IPv6, and is only configurable prior to specifying an explicit IPv6 address.
- **IPv6 Address** — Select list of configured IPv6 addresses for the selected Loopback interface. Add is also a valid choice if the maximum number of addresses has not been configured. This option only displays when the Protocol specified is IPv6.
- **IPv6 Address** — When Add is chosen from the IPv6 Address selector this IPv6 address input field becomes visible. Enter the address in the format of prefix/length. This option only displays when the Protocol specified is IPv6.
- **EUI64** — You also have the option to specify the 64-bit extended unique identifier (EUI-64). This option only displays when the Protocol specified is IPv6.
- **IPv4 Address** — The primary IPv4 address for this interface in dotted decimal notation. This option only displays when the Protocol specified is IPv4.
- **IPv4 Subnet Mask** — The primary IPv4 subnet mask for this interface in dotted decimal notation. This option only displays when the Protocol specified is IPv4.

The following fields display when a primary address is configured. You can configure multiple secondary addresses.

- **Secondary Address** — Select a configured IPv4 secondary address for the selected Loopback interface from the drop-down menu. A new address can be entered in the Secondary IP Address field by selecting Add Secondary IP Address here (if the maximum number of secondary addresses has not been configured). A primary address must be configured before a secondary address can be added.
- **Secondary IP Address** — The secondary IP address for this interface in dotted decimal notation. This input field is visible only when Add Secondary is selected.
- **Secondary Subnet Mask** — The secondary subnet mask for this interface in dotted decimal notation. This input field is visible only when Add Secondary is selected.

Creating a New Loopback (IPv4)

1. Open the **Loopbacks Configuration** page.
2. Select **Create** from the **Loopback** drop-down menu.
3. Specify an ID to use in the **Loopback ID** field.
4. Click **Apply Changes**.

The Loopback ID field goes away, and the remaining loopback fields display.

Figure 9-56. Loopbacks Configuration - IPv4 Entry

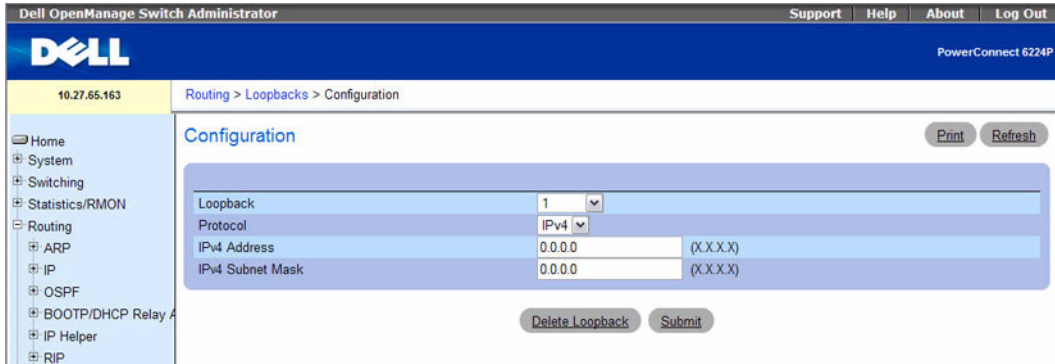

5. Enter IPv4 in the Protocol field.
6. Enter desired values in the remaining fields.
7. Click Submit.

The new loopback is saved, and the webpage reappears showing secondary address configuration fields.

Figure 9-57. Loopback Configuration - Add Secondary Address

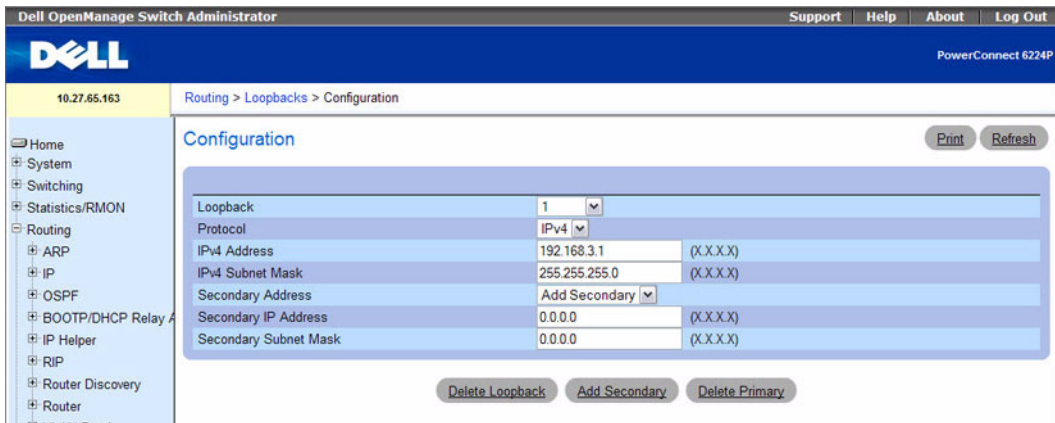

8. Complete the Secondary Address, Secondary IP Address, and Secondary Subnet Mask fields.
9. Click the Add Secondary button. The secondary address is saved, and the webpage reappears showing the primary and secondary loopback addresses.

Creating a New Loopback (IPv6)

1. Open the **Loopbacks Configuration** page.
2. Select **Create** from the **Loopback** drop-down menu.
3. Specify an ID to use in the **Loopback ID** field.
4. Click **Apply Changes**.

The Loopback ID field goes away, and the remaining loopback fields display.

Figure 9-58. Loopbacks Configuration - IPv6 Entry

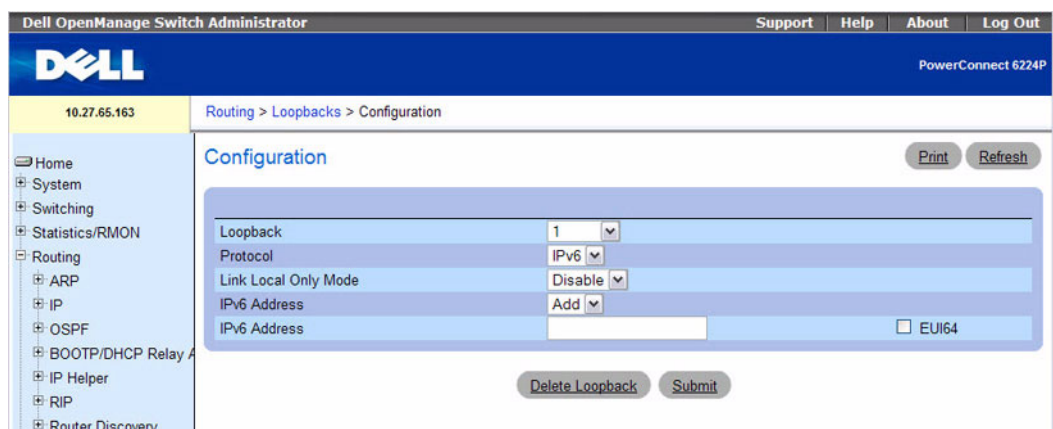

The screenshot shows the Dell OpenManage Switch Administrator interface. The top navigation bar includes 'Support', 'Help', 'About', and 'Log Out'. The main header displays the Dell logo and 'PowerConnect 6224P'. The breadcrumb trail indicates the current location: 'Routing > Loopbacks > Configuration'. The left-hand navigation menu is expanded to 'Routing', with sub-items like 'ARP', 'IP', 'OSPF', 'BOOTP/DHCP Relay A', 'IP Helper', 'RIP', and 'Router Discovery'. The main content area is titled 'Configuration' and contains a form for creating a new loopback. The form fields are: 'Loopback' (dropdown menu with '1' selected), 'Protocol' (dropdown menu with 'IPv6' selected), 'Link Local Only Mode' (dropdown menu with 'Disable' selected), and 'IPv6 Address' (dropdown menu with 'Add' selected). Below these fields is an empty text input field for the IPv6 address and a checkbox labeled 'EUI64'. At the bottom of the form are two buttons: 'Delete Loopback' and 'Submit'.

5. Choose **IPv6** from the drop-down box in the **Protocol** field.
6. Add the **IPv6 Address**.
7. Enter desired values in the remaining fields.
8. Click **Submit**.

The new loopback is saved, and the device is updated.

Configuring an Existing Loopback

1. Open the **Loopback Configuration** page.
2. Specify the loopback to configure in the **Loopback** drop-down menu.
3. Change field values as desired in the remaining fields.
4. Click **Apply Changes**.

The new configuration is saved, and the device is updated.

Removing a Loopback

1. Open the **Loopback Configuration** page.

2. Specify the loopback to remove in the **Loopback** drop-down menu.
3. Click **Delete Loopback**.

The loopback is deleted, and the device is updated.

Removing a Secondary Address

1. Open the **Loopback Configuration** page.
2. Specify the loopback to be affected.
3. Specify the secondary address to be removed.
4. Click **Delete Selected Secondary**.

The secondary address is deleted, and the device is updated.

Configuring a Loopback using CLI Commands

For information about the CLI commands that perform this function, see the following chapters in the *CLI Reference Guide*:

- Loopback Interface Commands
- IP Addressing Commands
- IPv6 Routing Commands

The following table summarizes the equivalent CLI commands for this feature.

Table 9-44. Loopback Commands

CLI Command	Description
interface loopback	Enters the Interface Loopback configuration mode.
ip address	Configures an IP address on an interface.
ipv6 address	Configures an IPv6 address on an interface (including tunnel and loopback interfaces).

Loopbacks Summary

Use the **Loopbacks Summary** page to display a summary of configured loopbacks.

To display the page, click **Routing** → **Loopbacks** → **Summary** in the tree view.

Figure 9-59. Loopbacks Summary

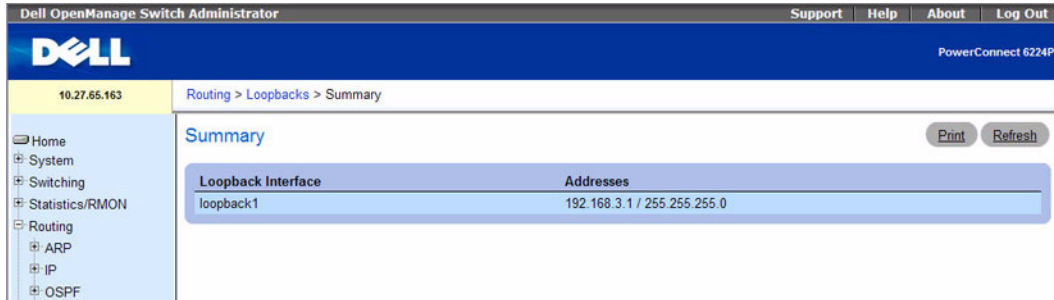

The Loopbacks Summary page displays the following fields:

- **Loopback Interface** — The ID of the configured loopback interface.
- **Addresses** — A list of the addresses configured on the loopback interface.

Displaying the Loopbacks Summary Using CLI Commands

For information about the CLI command that performs this function, see the following chapter in the *CLI Reference Guide*:

- Loopback Interface Commands

The following table summarizes the equivalent CLI commands for this feature.

Table 9-45. Loopback Summary Command

CLI Command	Description
show interface loopback	Displays information about configured loopback interfaces.

Configuring IPv6

Overview

The **IPv6** menu page contains links to the following features:

- Global Configuration
- Interface Configuration
- Interface Summary
- IPv6 Statistics
- IPv6 Neighbor Table
- DHCPv6
- OSPFv3
- IPv6 Routes

IPv6 is the next generation of the Internet Protocol. With 128-bit addresses, versus 32-bit addresses for IPv4, IPv6 solves the address depletion issues seen with IPv4 and removes the requirement for Network Address Translation (NAT), which is used in IPv4 networks to reduce the number of globally unique IP addresses required for a given network. Its aggregate addresses can dramatically reduce the size of the global routing table through well known address combinations. Security is more integrated and network configuration is simplified yet more flexible.

On the PowerConnect 6200 Series, IPv6 coexists with IPv4. As with IPv4, IPv6 routing can be enabled on loopback and VLAN interfaces. Each L3 routing interface can be used for IPv4, IPv6, or both. IP protocols running over L3 (for example, UDP and TCP) do not change with IPv6. For this reason, a single CPU stack is used for transport of both IPv4 and IPv6, and a single sockets interface provides access to both. Routing protocols are capable of computing routes for one or both IP versions.

Global Configuration

Use the **Global Configuration** page to enable IPv6 forwarding on the router, enable the forwarding of IPv6 unicast datagrams, and configure global IPv6 settings.

To display the page, click **IPv6** → **Global Configuration** in the tree view.

Figure 10-1. IPv6 Global Configuration

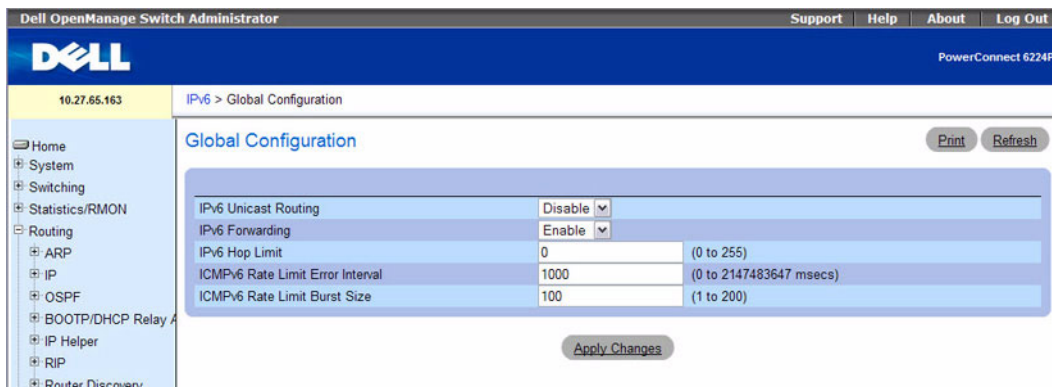

The **IPv6 Global Configuration** page contains the following fields:

- **IPv6 Unicast Routing** — Globally enable or disable IPv6 unicast routing on the router. The default is Disable.
- **IPv6 Forwarding** — Enable or disable forwarding of IPv6 frames on the router. The default is Enable.
- **IPv6 Hop Limit** — Specifies the TTL value for the router.
- **ICMPv6 Rate Limit Error Interval** — To control the ICMPv6 error packets, specify the number of ICMP error packets that are allowed per burst interval. The default Rate Limit is 100 packets per second. In other words, the burst interval is 1000 milliseconds. To disable ICMP Rate Limiting, set this value to zero. The Error Interval range is 0–2147483647.
- **ICMPv6 Rate Limit Burst Size** — To control the ICMPv6 error packets, specify the number of ICMP error packets that are allowed per burst interval. The default Burst Size is 100 packets. The valid Burst Size must be in the range of 1 to 200.

Configuring IPv6 Parameters

1. Open the **IPv6 Global Configuration** page.
2. Enable or disable unicast routing from the drop-down menu.
3. Enable or disable IPv6 frames forwarding from the drop-down menu.
4. Click **Apply Changes**.

Settings are saved, and the device is updated.

Configuring IPv6 Using CLI Commands

For information about the CLI commands that perform this function, see the following chapter in the *CLI Reference Guide*:

- IPv6 Routing Commands

The following table summarizes the equivalent CLI commands for this feature.

Table 10-1. IPv6 Routing Global Commands

CLI Command	Description
ipv6 forwarding	Enables IPv6 forwarding on a router.
ipv6 icmp error-interval	Limits the rate at which ICMP error messages are sent.
ipv6 unicast-routing	Enables forwarding of IPv6 unicast datagrams.
show ipv6 brief	Displays the IPv6 status of forwarding mode and IPv6 unicast routing mode.

Interface Configuration

Use the **Interface Configuration** page to configure IPv6 interface parameters. This page has been updated to include the IPv6 Destination Unreachables field.

To display the page, click **IPv6** → **Interface Configuration** in the tree view.

Figure 10-2. IPv6 Interface Configuration



The **IPv6 Interface Configuration** page contains the following fields:

- **Interface** — Selects the interface to be configured. When the selection is changed, a screen refresh occurs, causing all fields to be updated for the newly selected interface. Shows only routing-enabled interfaces and tunnels.
- **IPv6 Mode** — When IPv6 mode is enabled, interface is capable of IPv6 operation without a global address. In this case, an EUI-64 based link-local address is used. This selector lists the two options for IPv6 mode: **Enable** and **Disable**. Default value is **Disable**.

- **IPv6 Prefix** — Choose to **Add** or **Delete** an IPv6 prefix on this interface. If adding a prefix, specify that prefix in the following **IPv6 Prefix** field. Checking **Delete** causes deletion of a displayed IPv6 Prefix.
- **IPv6 Prefix** — Specifies the IPv6 prefix for an interface. When the selection is changed, the screen is refreshed and valid lifetime, preferred lifetime, on-link flag, and autonomous flag fields are updated for the selected IPv6 address.
- **EUI-64** — If checked, specifies 64-bit unicast prefix.
- **IPv6 Prefix Length** — Specifies the IPv6 prefix length.
- **Valid Lifetime by Prefix** — The value, in seconds, to be placed in the **Valid Lifetime** field of the **Prefix Information** option in a router advertisement. The prefix is valid for on-link determination for this length of time. Hosts that generate an address from this prefix using stateless address auto-configuration can use those addresses for this length of time. An auto-configured address older than the preferred lifetime but younger than the valid lifetime are considered to be deprecated addresses. As defined by RFC 2462, a deprecated address is an address assigned to an interface whose use is discouraged, but not forbidden. A deprecated address should no longer be used as a source address in new communications, but packets sent from or to deprecated addresses are delivered as expected. A deprecated address may continue to be used as a source address in communications where switching to a preferred address causes hardship to a specific upper-layer activity (for example, an existing TCP connection). The valid range is from 0 to 4,294,967,295 seconds.
- **Preferred Lifetime by Prefix** — The value, in seconds, to be placed in the **Preferred Lifetime** in the **Prefix Information** option in a router advertisement. Addresses generated from a prefix using stateless address autoconfiguration remain preferred for this length of time. As defined by RFC 2462, a preferred address is “an address assigned to an interface whose use by upper layer protocols is unrestricted. Preferred addresses may be used as the source (or destination) address of packets sent from (or to) the interface.” The range is from 0 to 4,294,967,295 seconds.
- **Onlink Flag by Prefix** — Specifies the selected prefix that can be used for on-link determination. Default value is Enable. This selector lists the two options for on-link flag: Enable and Disable.
- **Autonomous Flag by Prefix** — Specifies the selected prefix that can be used for autonomous address configuration. Default value is Disable. This selector lists the two options for autonomous flag: Enable and Disable.
- **Current State by Prefix** — Interface Operational status for selected IPv6 prefix.
- **Routing Mode** — Specifies the routing mode of an interface. This selector lists the two options for routing mode: Enable and Disable. Default value is Disable.
- **IPv6 Routing Operational Mode** — Displays the operational state of an interface.
- **Interface Maximum Transmit Unit** — Specifies the maximum transmit unit on an interface. If the value is 0 then this interface is not enabled for routing. It is not valid to set this value to 0 if routing is enabled. The valid range of MTU is 1280 to 1500.
- **Router Duplicate Address Detection Transmits** — Specifies the number of duplicate address detections transmits on an interface. DAD transmits values must be in the range of 0 to 600.

- **Router Advertisement NS Interval** — Specifies retransmission time field of router advertisement sent from the interface. A value of 0 means the interval is not specified for this router. The range of neighbor solicit interval is 1000 to 4294967295.
- **Router Lifetime Interval** — Specifies the router advertisement lifetime field sent from the interface. This value must be greater than or equal to the maximum advertisement interval. 0 means do not use the router as the default router. The range of router lifetime is 0 to 9000.
- **Router Advertisement Reachable Time** — Specifies the router advertisement time to consider neighbor reachable after the neighbor discovery (ND) confirmation. The range of reachable time is 0 to 3600000.
- **Router Advertisement Interval** — Specifies the maximum time allowed between sending router advertisements from the interface. The default value is 600. the range of maximum advertisement interval is 4 to 1800.
- **Router Advertisement Managed Config Flag** — Specifies the router advertisement managed address configuration flag. When true, the end nodes use DHCPv6. When false, the end nodes auto configure the addresses. The default value of managed flag is Disable.
- **Router Advertisement Other Config Flag** — Specifies the router advertisement other stateful configuration flag. The default value of other config flag is Disable.
- **Router Advertisement Suppress Flag** — Specifies the router advertisement suppression on an interface. The default value of suppress flag is Disable.
- **IPv6 Destination Unreachables** — Indicates whether the interface sends (Enabled) or suppresses (Disabled) ICMPv6 unreachable messages. This field also applies to tunnels.

Configuring IPv6 Interface

1. Open the **IPv6 Interface Configuration** page.
2. Modify the fields as needed.
3. Click **Apply Changes**.

The IPv6 interface modifications are saved, and the device is updated.

Configuring IPv6 Interface with the CLI Commands

For information about the CLI commands that perform this function, see the following chapter in the *CLI Reference Guide*:

- IPv6 Routing Commands

The following table summarizes the equivalent CLI commands for this feature.

Table 10-2. IPv6 Interface Routing Commands

CLI Command	Description
ipv6 address	Configures an IPv6 address on an interface (including tunnel and loopback interfaces).
ipv6 enable	Enables IPv6 routing on an interface (including tunnel and loopback interfaces) that has not been configured with an explicit IPv6 address.
ipv6 host	Defines static host name-to- ipv6 address mapping in the host cache.
ipv6 mtu	Sets the maximum transmission unit (MTU) size, in bytes, of IPv6 packets on an interface.
ipv6 nd dad attempts	Sets the number of duplicate address detection probes transmitted while doing neighbor discovery.
ipv6 nt managed-config-flag	Sets the “managed address configuration” flag in router advertisements.
ipv6 nd ns-interval	Sets the interval between router advertisements for advertised neighbor solicitations.
ipv6 nd other-config-flag	Sets the “other stateful configuration” flag in router advertisements sent from the interface.
ipv6 nd prefix	Sets the IPv6 prefixes to include in the router advertisement.
ipv6 nd ra-interval	Sets the transmission interval between router advertisements.
ipv6 nd ra-lifetime	Sets the value that is placed in the Router Lifetime field of the router advertisements sent from the interface.
ipv6 nd reachable-time	Sets the router advertisement time to consider a neighbor reachable after neighbor discovery confirmation.
ipv6 nd suppress-ra	Suppresses router advertisement transmission on an interface.
show ipv6 traffic	Shows traffic and statistics for IPv6 and ICMPv6.
show ipv6 vlan	Displays IPv6 VLAN routing interface addresses.

Interface Summary

Use the **Interface Summary** page to display settings for all IPv6 interfaces. To display the page, click **IPv6** → **Interface Summary** in the tree view.

Figure 10-3. IPv6 Interface Summary

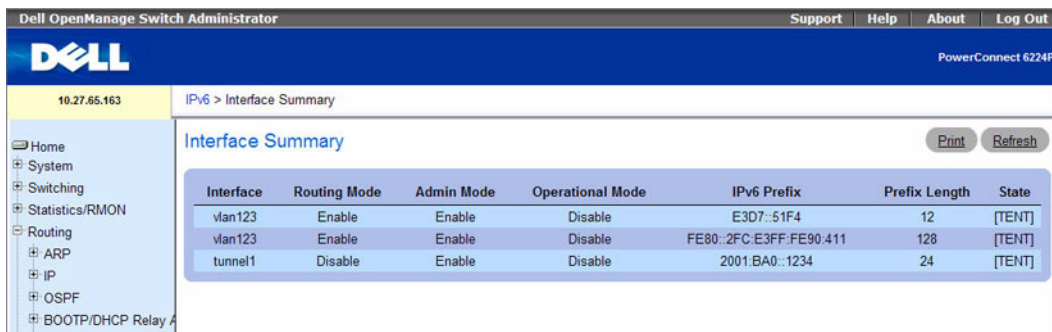

The **IPv6 Interface Summary** page contains the following fields:

- **Interface** — Specifies the interface whose settings are displayed in the current table row.
- **Routing Mode** — Specifies routing mode of the interface.
- **Admin Mode** — Specifies administrative mode of the interface.
- **Operational Mode** — Specifies operational mode of the interface.
- **IPv6 Prefix/PrefixLength** — Specifies configured IPv6 addresses on the interface.
- **State** — Specifies whether the interface is active or not.

Displaying IPv6 Interface Summary Using CLI Commands

For information about the CLI commands that perform this function, see the following chapter in the *CLI Reference Guide*:

- IPv6 Routing Commands

The following table summarizes the equivalent CLI commands for this feature.

Table 10-3. IPv6 Interface Summary Commands

CLI Command	Description
show ipv6 interface	Shows the usability status of IPv6 interfaces.

IPv6 Statistics

Use the **IPv6 Statistics** page to display IPv6 traffic statistics for one or all interfaces.

To display the page, click IPv6 → IPv6 Statistics in the tree view.

Figure 10-4. IPv6 Statistics

The screenshot shows the Dell OpenManage Switch Administrator interface. The top navigation bar includes 'Support', 'Help', 'About', and 'Log Out'. The main header displays the Dell logo and 'PowerConnect 6224P'. The left sidebar shows a tree view with 'IPv6' expanded to 'Statistics'. The main content area is titled 'IPv6 > Statistics' and features a dropdown menu for 'Interface' set to 'vlan111'. Below this are two tables of statistics.

IPv6 Statistics	
Total Datagrams Received	0
Received Datagrams Locally Delivered	0
Received Datagrams Discarded Due To Header Errors	0
Received Datagrams Discarded Due To MTU	0
Received Datagrams Discarded Due To No Route	0
Received Datagrams With Unknown Protocol	0
Received Datagrams Discarded Due To Invalid Address	0
Received Datagrams Discarded Due To Truncated Data	0
Received Datagrams Discarded Other	0
Received Datagrams Reassembly Required	0
Datagrams Successfully Reassembled	0
Datagrams Failed To Reassemble	0
Datagrams Forwarded	0
Datagrams Locally Transmitted	0
Datagrams Transmit Failed	0
Datagrams Successfully Fragmented	0
Datagrams Failed To Fragment	0
Datagrams Fragments Created	0
Multicast Datagrams Received	0
Multicast Datagrams Transmitted	0

ICMPv6 Statistics	
Total ICMPv6 Messages Received	0
ICMPv6 Messages With Errors Received	0
ICMPv6 Destination Unreachable Messages Received	0
ICMPv6 Messages Prohibited Administratively Received	0
ICMPv6 Time Exceeded Messages Received	0
ICMPv6 Parameter Problem Messages Received	0
ICMPv6 Packet Too Big Messages Received	0
ICMPv6 Echo Request Messages Received	0
ICMPv6 Echo Reply Messages Received	0
ICMPv6 Router Solicit Messages Received	0
ICMPv6 Router Advertisement Messages Received	0
ICMPv6 Neighbor Solicit Messages Received	0

The IPv6 Statistics page contains the following fields:

- **Interface** — Selects the interface for which statistics are displayed. When the selection is changed, a screen refresh occurs, causing all fields to be updated for the newly selected interface.

IPv6 Statistics

- **Total Datagrams Received** — The total number of input datagrams received by the interface, including those received in error.

- **Received Datagrams Locally Delivered** — The total number of datagrams successfully delivered to IPv6 user-protocols (including ICMP). This counter is incremented at the interface to which these datagrams were addressed, which might not be necessarily the input interface for some of the datagrams.
- **Received Datagrams Discarded Due To Header Errors** — The number of input datagrams discarded due to errors in their IPv6 headers, including version number mismatch, other format errors, hop count exceeded, errors discovered in processing their IPv6 options, etc.
- **Received Datagrams Discarded Due To MTU** — The number of input datagrams that could not be forwarded because their size exceeded the link MTU of outgoing interface.
- **Received Datagrams Discarded Due To No Route** — The number of input datagrams discarded because no route could be found to transmit them to their destination.
- **Received Datagrams With Unknown Protocol** — The number of locally-addressed datagrams received successfully but discarded because of an unknown or unsupported protocol. This counter is incremented at the interface to which these datagrams were addressed which might not be necessarily the input interface for some of the datagrams.
- **Received Datagrams Discarded Due To Invalid Address** — The number of input datagrams discarded because the IPv6 address in their IPv6 header's destination field was not a valid address to be received at this entity. This count includes invalid addresses (for example, ::0) and unsupported addresses (for example, addresses with unallocated prefixes). For entities which are not IPv6 routers and therefore do not forward datagrams, this counter includes datagrams discarded because the destination address was not a local address.
- **Received Datagrams Discarded Due To Truncated Data** — The number of input datagrams discarded because datagram frame didn't carry enough data.
- **Received Datagrams Discarded Other** — The number of input IPv6 datagrams for which no problems were encountered to prevent their continued processing, but which were discarded (for example, for lack of buffer space). Note that this counter does not include any datagrams discarded while awaiting re-assembly.
- **Received Datagrams Reassembly Required** — The number of IPv6 fragments received which needed to be reassembled at this interface. Note that this counter is incremented at the interface to which these fragments were addressed which might not be necessarily the input interface for some of the fragments.
- **Datagrams Successfully Reassembled** — The number of IPv6 datagrams successfully reassembled. Note that this counter is incremented at the interface to which these datagrams were addressed which might not be necessarily the input interface for some of the fragments.
- **Datagrams Failed To Reassemble** — The number of failures detected by the IPv6 reassembly algorithm (for whatever reason: timed out, errors, etc.). Note that this is not necessarily a count of discarded IPv6 fragments since some algorithms (notably the algorithm in RFC 815) can lose track of the number of fragments by combining them as they are received. This counter is incremented at the interface to which these fragments were addressed which might not be necessarily the input interface for some of the fragments.

- **Datagrams Forwarded** — The number of output datagrams which this entity received and forwarded to their final destinations. In entities which do not act as IPv6 routers, this counter includes only those packets which were Source-Routed through this entity, and the Source-Route processing was successful. Note that for a successfully forwarded datagram the counter of the outgoing interface is incremented.
- **Datagrams Locally Transmitted** — The number of datagrams which this entity has successfully transmitted from this output interface.
- **Datagrams Transmit Failed** — The number of datagrams which this entity failed to transmit successfully.
- **Datagrams Successfully Fragmented** — The number of IPv6 datagrams that have been successfully fragmented at this output interface.
- **Datagrams Failed To Fragment** — The number of output datagrams that could not be fragmented at this interface.
- **Datagrams Fragments Created** — The number of output datagram fragments that have been generated as a result of fragmentation at this output interface.
- **Multicast Datagrams Received** — The number of multicast packets received by the interface.
- **Multicast Datagrams Transmitted** — The number of multicast packets transmitted by the interface.

ICMPv6 Statistics

- **Total ICMPv6 Messages Received** — The total number of ICMP messages received by the interface which includes all those counted by `ipv6IfIcmpInErrors`. Note that this interface is the interface to which the ICMP messages were addressed which may not be necessarily the input interface for the messages.
- **ICMPv6 Messages With Errors Received** — The number of ICMP messages which the interface received but determined as having ICMP-specific errors (bad ICMP checksums, bad length, etc.)
- **ICMPv6 Destination Unreachable Messages Received** — The number of ICMP Destination Unreachable messages received by the interface.
- **ICMPv6 Messages Prohibited Administratively Received** — The number of ICMP destination unreachable/communication administratively prohibited messages received by the interface.
- **ICMPv6 Time Exceeded Messages Received** — The number of ICMP Time Exceeded messages received by the interface.
- **ICMPv6 Parameter Problem Messages Received** — The number of ICMP Parameter Problem messages received by the interface.
- **ICMPv6 Packet Too Big Messages Received** — The number of ICMP Packet Too Big messages received by the interface.
- **ICMPv6 Echo Request Messages Received** — The number of ICMP Echo (request) messages received by the interface.
- **ICMPv6 Echo Reply Messages Received** — The number of ICMP Echo Reply messages received by the interface.

- **ICMPv6 Router Solicit Messages Received** — The number of ICMP Router Solicit messages received by the interface.
- **ICMPv6 Router Advertisement Messages Received** — The number of ICMP Router Advertisement messages received by the interface.
- **ICMPv6 Neighbor Solicit Messages Received** — The number of ICMP Neighbor Solicit messages received by the interface.
- **ICMPv6 Neighbor Advertisement Messages Received** — The number of ICMP Neighbor Advertisement messages received by the interface.
- **ICMPv6 Redirect Messages Received** — The number of ICMPv6 Redirect messages received by the interface.
- **ICMPv6 Group Membership Query Messages Received** — The number of ICMPv6 Group Membership Query messages received by the interface.
- **ICMPv6 Group Membership Response Messages Received** — The number of ICMPv6 Group Membership Response messages received by the interface.
- **ICMPv6 Group Membership Reduction Messages Received** — The number of ICMPv6 Group Membership Reduction messages received by the interface.
- **Total ICMPv6 Messages Transmitted** — The total number of ICMP messages which this interface attempted to send. Note that this counter includes all those counted by icmpOutErrors.
- **ICMPv6 Messages Not Transmitted Due To Error** — The number of ICMP messages which this interface did not send due to problems discovered within ICMP such as a lack of buffers. This value should not include errors discovered outside the ICMP layer such as the inability of IPv6 to route the resultant datagram. In some implementations there may be no types of error which contribute to this counter's value.
- **ICMPv6 Destination Unreachable Messages Transmitted** — The number of ICMP Destination Unreachable Messages sent by the interface.
- **ICMPv6 Messages Prohibited Administratively Transmitted** — Number of ICMP destination unreachable/communication administratively prohibited messages sent.
- **ICMPv6 Time Exceeded Messages Transmitted** — The number of ICMP Time Exceeded messages sent by the interface.
- **ICMPv6 Parameter Problem Messages Transmitted** — The number of ICMP Parameter Problem messages sent by the interface.
- **ICMPv6 Packet Too Big Messages Transmitted** — The number of ICMP Packet Too Big messages sent by the interface.
- **ICMPv6 Echo Request Messages Transmitted** — The number of ICMP Echo (request) messages sent by the interface.
- **ICMPv6 Echo Reply Messages Transmitted** — The number of ICMP Echo Reply messages sent by the interface.

- **ICMPv6 Router Solicit Messages Transmitted** — The number of ICMP Router Solicitation messages sent by the interface.
- **ICMPv6 Router Advertisement Messages Transmitted** — The number of ICMP Router Advertisement messages sent by the interface.
- **ICMPv6 Neighbor Solicit Messages Transmitted** — The number of ICMP Neighbor Solicitation messages sent by the interface.
- **ICMPv6 Neighbor Advertisement Messages Transmitted** — The number of ICMP Neighbor Advertisement messages sent by the interface.
- **ICMPv6 Redirect Messages Transmitted** — The number of Redirect messages sent.
- **ICMPv6 Group Membership Query Messages Transmitted** — The number of ICMPv6 Group Membership Query messages sent.
- **ICMPv6 Group Membership Response Messages Transmitted** — The number of ICMPv6 Group Membership Response messages sent.
- **ICMPv6 Group Membership Reduction Messages Transmitted** — The number of ICMPv6 Group Membership Reduction messages sent.
- **ICMPv6 Duplicate Address Detects** — The number of duplicate Addressees detected by the interface.

Displaying IPv6 Statistics

1. Open the IPv6 Statistics page.
2. Select the interface to be displayed from the **Interface** drop-down menu.
Statistics for the selected interface display.

Displaying IPv6 and ICMPv6 Statistics Using CLI Commands

For information about the CLI commands that perform this function, see the following chapter in the *CLI Reference Guide*:

- IPv6 Routing Commands

The following table summarizes the equivalent CLI commands for this feature.

Table 10-4. IPv6 Statistics Commands

CLI Command	Description
show ipv6 traffic	Displays IPv6 statistics.
clear ipv6 statistics	Clears IPv6 statistics for all interfaces or for a specific interface, including loopback and tunnel interfaces.

IPv6 Neighbor Table

Use the IPv6 Neighbor Table page to display IPv6 neighbor details for a specified interface. To display the page, click IPv6 → IPv6 Neighbor Table in the tree view.

Figure 10-5. IPv6 Neighbor Table



The IPv6 Neighbor Table page contains the following fields:

- **Interface** — Selects the interface for which neighbor state information is displayed.
- **Interface** — Specifies the interface whose settings are displayed in the current table row.
- **IPv6 Address** — Specifies the IPv6 address of neighbor or interface.
- **MAC Address** — Specifies MAC address associated with an interface.
- **IsRtr** — Indicates whether the neighbor is a router. If the neighbor is a router, the value is TRUE. If the neighbor is not a router, the value is FALSE.
- **Neighbor State** — Specifies the state of the neighbor cache entry. Following are the states for dynamic entries in the IPv6 neighbor discovery cache:
 - **Incmp** — Address resolution is being performed on the entry. A neighbor solicitation message has been sent to the solicited-node multicast address of the target, but the corresponding neighbor advertisement message has not yet been received.

- **Reachable** — Positive confirmation was received within the last Reachable Time milliseconds that the forward path to the neighbor was functioning properly. While in REACH state, the device takes no special action as packets are sent.
- **Stale** — More than ReachableTime milliseconds have elapsed since the last positive confirmation was received that the forward path was functioning properly. While in STALE state, the device takes no action until a packet is sent.
- **Delay** — More than ReachableTime milliseconds have elapsed since the last positive confirmation was received that the forward path was functioning properly. A packet was sent within the last DELAY_FIRST_PROBE_TIME seconds. If no reachability confirmation is received within DELAY_FIRST_PROBE_TIME seconds of entering the DELAY state, send a neighbor solicitation message and change the state to PROBE.
- **Probe** — A reachability confirmation is actively sought by resending neighbor solicitation messages every RetransTimer milliseconds until a reachability confirmation is received.
- **Last Updated** — Time since the address was confirmed to be reachable.

Displaying IPv6 Neighbor Table

1. Open the IPv6 Neighbor Table page.
2. Select the interface to be displayed from the **Interface** drop-down menu.
Neighbor details for the selected interface display.

Displaying IPv6 Neighbor Table Using CLI Commands

For information about the CLI commands that perform this function, see the following chapter in the *CLI Reference Guide*:

- IPv6 Routing Commands

The following table summarizes the equivalent CLI commands for this feature.

Table 10-5. IPv6 Neighbor Table Commands

CLI Command	Description
show ipv6 neighbors	Displays information about IPv6 neighbors.
clear ipv6 neighbors	Clears all entries in the IPv6 neighbor table or an entry on a specific interface.

DHCPv6

DHCP is generally used between clients (for example hosts) and servers (for example routers) for the purpose of assigning IP addresses, gateways, and other networking definitions such as DNS, NTP, and/or Session Initiation Protocol (SIP) parameters. However, IPv6 natively provides for auto configuration of IP addresses through IPv6 Neighbor Discovery Protocol (NDP) and the use of Router Advertisement messages. Thus, the role of DHCPv6 within the network is different than that of DHCPv4 in that it is less relied upon for IP address assignment.

There is a list of DHCP options that is commonly supported by DHCPv4 that need to be supported also by DHCPv6, and must be configured.

 **NOTE:** The most important DHCP option to configure is the DNS Server option, which is configured on the **IPv6 → DHCPv6 → Pool Configuration** web page.

The **DHCPv6** menu page contains links to web pages that define and display DHCPv6 parameters and data. To display this page, click **IPv6 → DHCPv6** in the tree view. Following are the web pages accessible from this menu page:

- DHCPv6 Global Configuration
- DHCPv6 Pool Configuration
- Prefix Delegation Configuration
- DHCPv6 Pool Summary
- DHCPv6 Interface Configuration
- DHCPv6 Server Bindings Summary
- DHCPv6 Statistics

DHCPv6 Global Configuration

Use the **DHCPv6 Global Configuration** page to configure DHCPv6 global parameters. To display the page, click **IPv6 → DHCPv6 → Global Configuration** in the tree view.

Figure 10-6. DHCPv6 Global Configuration

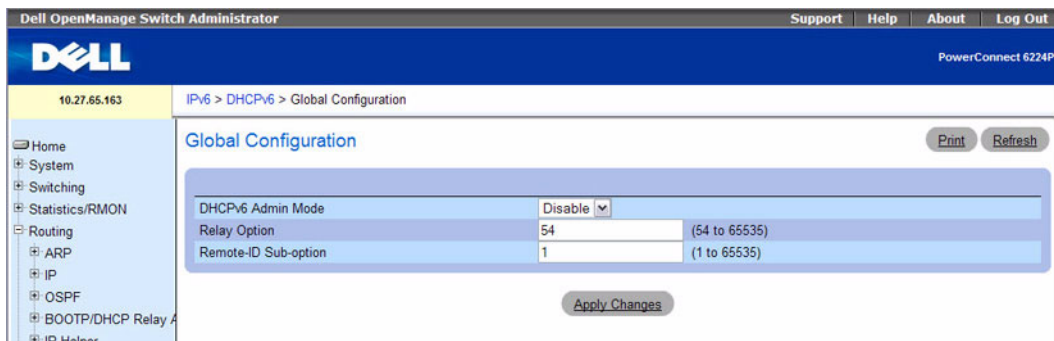

The **DHCPv6 Global Configuration** page contains the following fields:

- **DHCPv6 Admin Mode** — Specifies DHCPv6 operation on the switch. Possible values are Enable and Disable; the default value is Disable.
- **Relay Option** — Specifies Relay Agent Information Option value. The values allowed are between 32 to 65535, and represent the value exchanged between the relay agent and the server. Each value has a different meaning, of which 1 to 39 are standardized. The default value, 32, means `OPTION_INFORMATION_REFRESH_TIME`.
- **Remote-id Sub-option** — Lets you specify a number to represent the Relay Agent Information Option Remote-ID Sub-option type. The values allowed are between 1 and 65535. The default value is 1.

Configuring DHCPv6 Global Parameters

1. Open the **DHCPv6 Global Configuration** page.
2. Modify the fields as needed.
3. Click **Apply Changes**.

The DHCPv6 parameter modifications are saved, and the device is updated.

Configuring DHCPv6 Global Parameters Using CLI Commands

For information about the CLI commands that perform this function, see the following chapter in the *CLI Reference Guide*:

- DHCPv6 Commands

The following table summarizes the equivalent CLI commands for this feature.

Table 10-6. DHCPv6 Global Commands

CLI Command	Description
service dhcpv6	Enables DHCPv6 configuration on the router.
show ipv6 dhcp	Displays the DHCPv6 server name and status.

DHCPv6 Pool Configuration

DHCP for IPv6 clients are connected to a server which is configured to use parameters from a pool that you set up. The pool is identified with a pool name, and contains IPv6 addresses and domain names of DNS servers.

Use the **Pool Configuration** page to create a pool and/or configure pool parameters.

To display the page, click **IPv6** → **DHCPv6** → **Pool Configuration** in the tree view.

Figure 10-7. Pool Configuration - Create

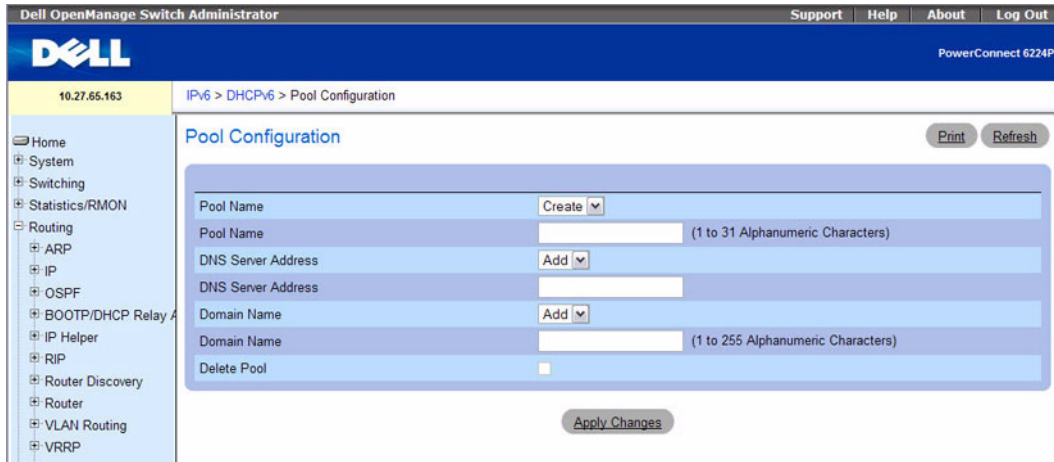

The **Pool Configuration** page contains the following fields:

- **Pool Name** — Drop-down menu that lists all the pool names configured. When **Create** is selected, fields on the page are cleared of data, in preparation for new pool information.
- **Pool Name** — Displays the pool selected from the previous field, or provides entry of a unique name for a DHCPv6 pool when **Create** is selected. A maximum of 31 alphanumeric characters can be entered.
- **DNS Server Address** — Drop-down menu that specifies the IPv6 address of a DNS server within a particular DHCPv6 pool. When **Add** is selected from the menu, the following field is cleared of data, in preparation for a new address.
- **DNS Server Address** — Displays the selected DNS server address from the previous field. Enter a new DNS server address here when **Add** is selected in the previous field. Click **Delete** to remove an address from this pool. The address is deleted when **Apply Changes** is clicked.
- **Domain Name** — Drop-down menu that specifies the list of domain names configured within a particular DHCPv6 pool. When **Add** is selected from the menu, the following field is cleared of data, in preparation for a new name.
- **Domain Name** — Displays the selected DNS domain name from the previous field. Enter a new DNS domain name here when **Add** is selected in the previous field. A maximum of 255 alphanumeric characters can be entered. Click **Delete** to remove a domain name from this pool. The name is deleted when **Apply Changes** is clicked.
- **Delete Pool** — Check this box to delete the displayed pool. The pool is deleted when **Apply Changes** is clicked.

Creating a DHCPv6 Pool

1. Open the **Pool Configuration** page.
2. Select Create from the Pool Name drop-down menu.
3. Enter a new name in the Pool Name field.
4. Specify an existing DNS Server Address to associate with this pool, or create a new one.
5. Specify an existing Domain Name to associate with this pool, or create a new one.
6. Click **Apply Changes**.

The new pool is saved, and the device is updated. If a new DNS server address or domain name was specified, it is also saved.

Modifying DHCPv6 Pool Parameters

1. Open the **Pool Configuration** page.
2. Select the pool for which parameters are changing from the drop-down Pool Name menu.
3. Change or set up a new DNS Server Address for the specified pool.
4. Change or set up a new Domain Name for the specified pool.
5. Click **Apply Changes**.

The DHCPv6 Pool parameter modifications are saved, and the device is updated.

Deleting a DHCPv6 Pool or Parameter

1. Open the **Pool Configuration** page.
2. Select the pool to be affected from the drop-down Pool Name menu.
3. Click the Delete box if deleting the DNS Server Address for this pool.
4. Click the Delete box if deleting the Domain Name for this pool.
5. Click the Delete Pool box if deleting the entire pool.
6. Click **Apply Changes**.

The pool or its parameter setting is deleted, and the device is updated.

Configuring DHCPv6 Pool Parameters Using CLI Commands

For information about the CLI commands that perform this function, see the following chapter in the *CLI Reference Guide*:

- DHCPv6 Commands

The following table summarizes the equivalent CLI commands for this feature.

Table 10-7. DHCPv6 Pool Configuration Commands

CLI Command	Description
dns-server	Sets the ipv6 DNS server address which is provided to a DHCPv6 client by the DHCPv6 server.
domain-name	Sets the DNS domain name which is provided to a DHCPv6 client by the DHCPv6 server.
ipv6 dhcp pool	Enters IPv6 DHCP Pool Configuration mode.

Prefix Delegation Configuration

Use the **Prefix Delegation Configuration** page to configure a delegated prefix for a pool. At least one pool must be created using DHCPv6 Pool Configuration before a delegated prefix can be configured. To display the page, click **IPv6** → **DHCPv6** → **Prefix Delegation Configuration** in the tree view.

Figure 10-8. Prefix Delegation Configuration

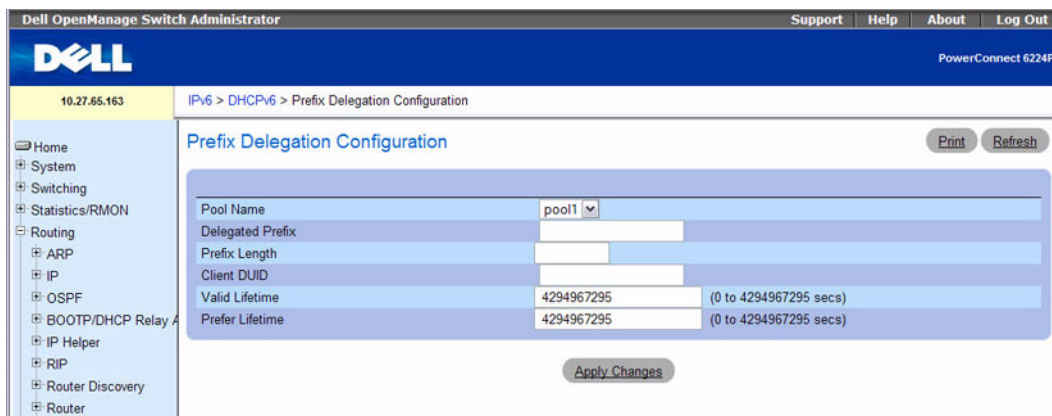

The **Prefix Delegation Configuration** page contains the following fields:

- **Pool Name** — Specifies all the pool names configured. Select the pool to configure.
- **Delegated Prefix** — Drop-down menu that specifies the delegated IPv6 prefix to associate with the specified pool. Select **Add** to define a new delegated prefix for this pool.
- **Delegated Prefix** — Displays selected delegated prefix or allows entry of new one.
- **DUID List** - Drop-down menu that selects the client's unique DUID value. Select **Add** to define a new DUID value for this pool.
- **DUID** - Displays selected DUID value or allows entry of new one.
- **Valid Lifetime** — Specifies the valid lifetime in seconds for delegated prefix.

- **Prefer Lifetime** — Specifies the prefer lifetime in seconds for delegated prefix.
- **Delete** — Deletes the displayed pool prefix delegation configuration when checked and **Apply Changes** is clicked.

Configuring a delegated prefix to a Pool

1. Open the **Prefix Delegation Configuration** page.
2. Select the pool to be configured.
3. Specify the delegated prefix.
4. Modify the remaining fields as needed.
5. Click **Apply Changes**.

The delegated prefix and parameters are saved, and the device is updated.

Configuring a delegated prefix Using CLI Commands

For information about the CLI commands that perform this function, see the following chapter in the *CLI Reference Guide*:

- DHCPv6 Commands

The following table summarizes the equivalent CLI commands for this feature.

Table 10-8. DHCPv6 Prefix Delegation Command

CLI Command	Description
prefix-delegation	Defines Multiple IPv6 prefixes within a pool for distributing to specific DHCPv6 Prefix delegation clients.

DHCPv6 Pool Summary

Use the **Pool Summary** page to display settings for all DHCPv6 Pools. At least one pool must be created using DHCPv6 Pool Configuration before the Pool Summary displays.

To display the page, click **IPv6** → **DHCPv6** → **Pool Summary** in the tree view.

Figure 10-9. Pool Summary

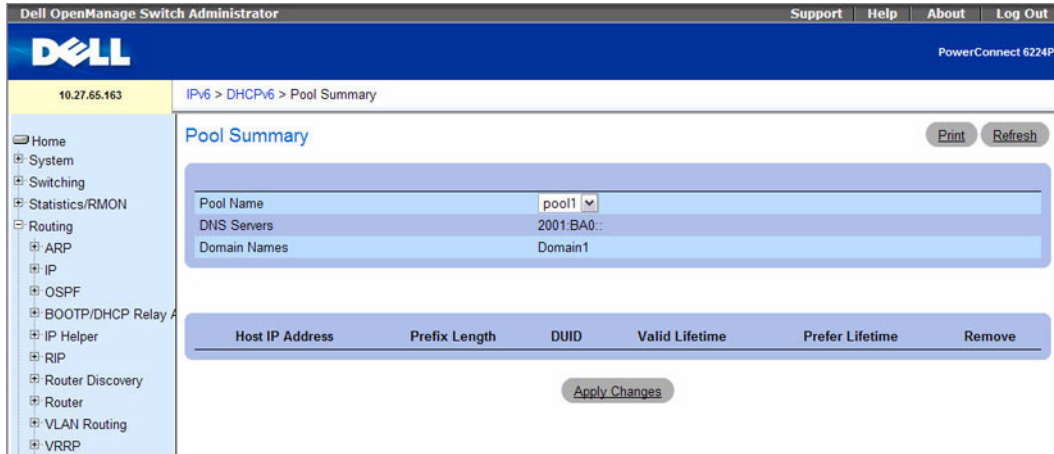

The Pool Summary page contains the following fields:

- **Pool Name** — Selects the pool to display.
- **DNS Server** — Displays the IPv6 address of the associated DNS server.
- **Domain Name** — Displays the DNS domain name.
- **Host IP Address** — Displays the IPv6 address and mask length for the delegated prefix.
- **DUID** — Identifier used to identify the client's unique DUID value.
- **Valid Lifetime** — Displays the valid lifetime in seconds for delegated prefix.
- **Prefer Lifetime** — Displays the preferred lifetime in seconds for delegated prefix.

Displaying the Pool Summary Using CLI Commands

For information about the CLI commands that perform this function, see the following chapter in the *CLI Reference Guide*:

- DHCPv6 Commands

The following table summarizes the equivalent CLI commands for this feature.

Table 10-9. DHCPv6 Pool Summary Command

CLI Command	Description
show ipv6 dhcp pool	Displays the configured DHCP pool.

DHCPv6 Interface Configuration

Use the **DHCPv6 Interface Configuration** page to configure a DHCPv6 interface.

To display the page, click IPv6 → DHCPv6 → Interface Configuration in the tree view.

Figure 10-10. DHCPv6 Interface Configuration

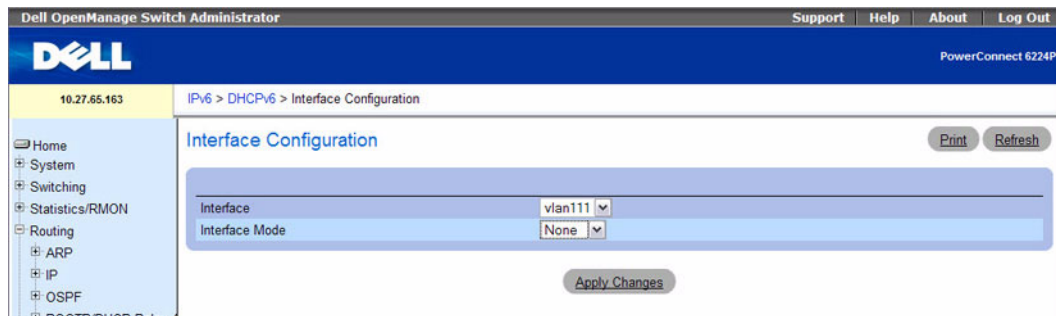

The fields that display on the **DHCPv6 Interface Configuration** pages depend on the value selected in the **Interface Mode** field. The following list describes all the possible fields on the page:

- **Interface** — Select the interface for which you are configuring DHCPv6 server functionality.
- **Interface Mode** — Configure the DHCPv6 mode as either Server or Relay. DHCPv6 server and DHCPv6 relay functions are mutually exclusive.
- **Pool Name** — Selects the DHCPv6 pool containing stateless and/or prefix delegation parameters. This field displays when the Interface Mode is Server.
- **Rapid Commit** — Rapid commit is an optional parameter. Specified to allow abbreviated exchange between the client and server. This field displays when the Interface Mode is Server.
- **Preference** — Selects the preference value used by clients to determine preference between multiple DHCPv6 servers. The values allowed are between 0 to 4294967295. This field displays when the Interface Mode is Server.
- **Delete** — Check this box and click **Apply Changes** to delete this configuration. This field displays when the Interface Mode is Server or Relay.
- **Relay Interface** — Selects the interface to reach a relay server. This field displays when the Interface Mode is Relay.
- **Destination IP Address** — Selects the IPv6 address of the DHCPv6 relay server. This field displays when the Interface Mode is Relay.
- **Remote ID** — Selects the relay agent information option. the Remote ID needs to be derived from the DHCPv6 server DUID and the relay interface number, or it can be specified as a user-defined string. This field displays when the Interface Mode is Relay.

Configuring a DHCPv6 Interface for Relay Interface Mode

1. Open the **DHCPv6 Interface Configuration** page.
2. Specify the desired Interface, and select **Relay** from the **Interface Mode** drop down menu.

The following screen appears:

Figure 10-11. DHCPv6 Interface Configuration - Relay

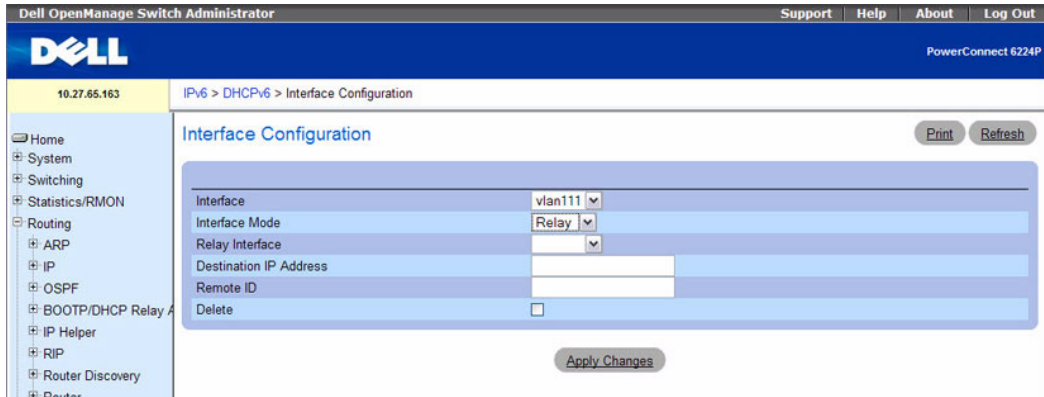

3. Modify the fields as needed.
4. Click Apply Changes.

The DHCPv6 interface configuration is saved, and the device is updated.

Configuring a DHCPv6 Interface for Server Interface Mode

1. Open the DHCPv6 Interface Configuration page.
2. Specify the desired Interface, and select Server from the Interface Mode drop down menu.

The following screen appears:

Figure 10-12. DHCPv6 Interface Configuration - Server

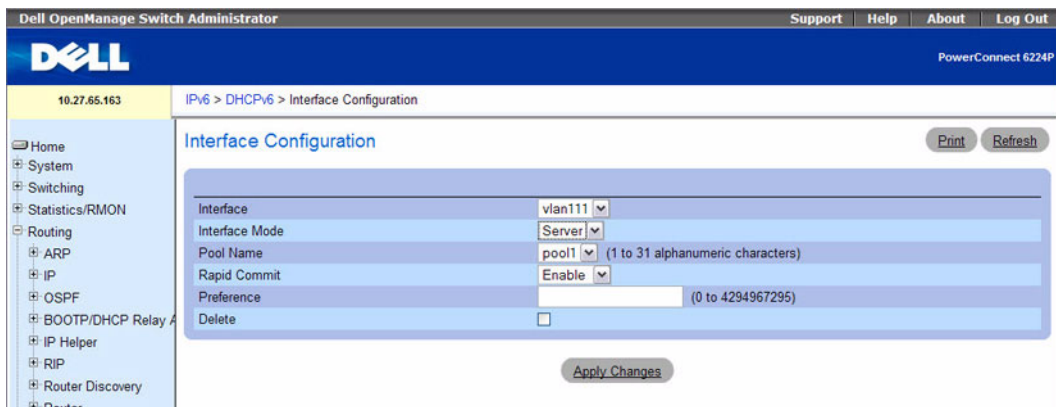

3. Modify the fields as needed.
4. Click Apply Changes.

The DHCPv6 interface configuration is saved, and the device is updated.

Configuring a DHCPv6 Interface Using CLI Commands

For information about the CLI commands that perform this function, see the following chapter in the *CLI Reference Guide*:

- DHCPv6 Commands

The following table summarizes the equivalent CLI commands for this feature.

Table 10-10. DHCPv6 Interface Configuration Commands

CLI Command	Description
ipv6 dhcp relay	Configures an interface for DHCPv6 relay functionality.
ipv6 dhcp relay-agent-info-opt	Configures a number to represent the DHCPv6 Relay Agent Information Option.
ipv6 dhcp relay-agent-info-remote-id-subopt	Configures a number to represent the DHCPv6 the “remote-id” sub-option.
ipv6 dhcp server	Configures DHCPv6 server functionality on an interface.
show ipv6 dhcp interface	Displays DHCPv6 information for all relevant interfaces or a specified interface.

DHCPv6 Server Bindings Summary

Use the Server Bindings Summary page to display all DHCPv6 server bindings. To display the page, click IPv6 →DHCPv6 →Bindings Summary in the tree view.

Figure 10-13. Server Bindings Summary

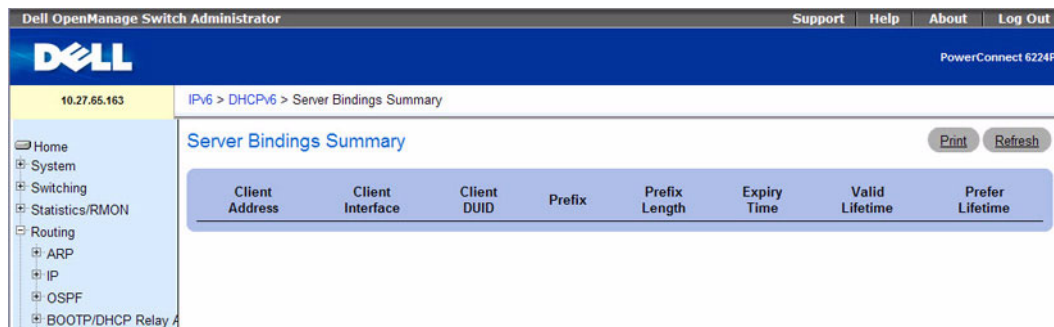

The Server Bindings Summary page contains the following fields:

- **Client Address** — Specifies the IPv6 address of the client associated with the binding.
- **Client Interface** — Specifies the interface number where the client binding occurred.
- **Client DUID** — Specifies client's DHCPv6 unique identifier.
- **Prefix** - Specifies the type of prefix associated with this binding.
- **Expiry Time** — Specifies the number of seconds until the prefix associated with a binding expires.
- **Valid Lifetime** — Specifies the valid lifetime value in seconds of the prefix associated with a binding.
- **Prefer Lifetime** — Specifies the preferred lifetime value in seconds of the prefix associated with a binding.

Displaying Server Bindings Using CLI Commands

For information about the CLI commands that perform this function, see the following chapter in the *CLI Reference Guide*:

- DHCPv6 Commands

The following table summarizes the equivalent CLI commands for this feature.

Table 10-11. DHCPv6 Binding Commands

CLI Command	Description
show ipv6 dhcp binding	Displays the configured DHCP pool.

DHCPv6 Statistics

Use the DHCPv6 Statistics page to display DHCPv6 statistics for one or all interfaces.

To display the page, click IPv6 → DHCPv6 → Statistics in the tree view.

Figure 10-14. DHCPv6 Statistics

The screenshot shows the Dell OpenManage Switch Administrator interface. The breadcrumb path is IPv6 > DHCPv6 > Statistics. The 'Interface' dropdown is set to 'vlan111'. The 'Messages Received' table shows the following data:

Message Type	Count
DHCPv6 Solicit Packets Received	0
DHCPv6 Request Packets Received	0
DHCPv6 Confirm Packets Received	0
DHCPv6 Renew Packets Received	0
DHCPv6 Rebind Packets Received	0
DHCPv6 Release Packets Received	0
DHCPv6 Decline Packets Received	0
DHCPv6 Inform Packets Received	0
DHCPv6 Relay-forward Packets Received	0
DHCPv6 Relay-reply Packets Received	0
DHCPv6 Malformed Packets Received	0
Received DHCPv6 Packets Discarded	0
Total DHCPv6 Packets Received	0

The 'Messages Sent' table shows the following data:

Message Type	Count
DHCPv6 Advertisement Packets Transmitted	0
DHCPv6 Reply Packets Transmitted	0
DHCPv6 Reconfig Packets Transmitted	0
DHCPv6 Relay-forward Packets Transmitted	0
DHCPv6 Relay-reply Packets Transmitted	0
Total DHCPv6 Packets Sent	0

The DHCPv6 Statistics page displays the following fields:

- **Interface** — Select the interface for which data is to be displayed or configured. On selecting All, data is shown for all interfaces.

Messages Received

This section specifies the aggregate of all interface level statistics for received messages:

- **DHCPv6 Solicit Packets Received** — Specifies the number of Solicits.
- **DHCPv6 Request Packets Received** — Specifies the number of Requests.
- **DHCPv6 Confirm Packets Received** — Specifies the number of Confirms.

- **DHCPv6 Renew Packets Received** — Specifies the number of Renews.
- **DHCPv6 Rebind Packets Received** — Specifies the number of Rebinds.
- **DHCPv6 Release Packets Received** — Specifies the number of Releases.
- **DHCPv6 Decline Packets Received** — Specifies the number of Declines.
- **DHCPv6 Inform Packets Received** — Specifies the number of Informs.
- **DHCPv6 Relay-forward Packets Received** — Specifies the number of Relay forwards.
- **DHCPv6 Relay-reply Packets Received** — Specifies the number of Relay Replies.
- **DHCPv6 Malformed Packets Received** — Specifies the number of Malformed Packets.
- **Received DHCPv6 Packets Discarded** — Specifies the number of Packets Discarded.
- **Total DHCPv6 Packets Received** — Specifies the total number of Packets Received.

Messages Sent

This section specifies the aggregate of all interface level statistics for messages sent:

- **DHCPv6 Advertisement Packets Transmitted** — Specifies the number of Advertisements.
- **DHCPv6 Reply Packets Transmitted** — Specifies the number of Replies.
- **DHCPv6 Reconfig Packets Transmitted** — Specifies the number of Reconfigurations.
- **DHCPv6 Relay-forward Packets Transmitted** — Specifies the number of Relay forwards.
- **DHCPv6 Relay-reply Packets Transmitted** — Specifies the number of Relay Replies.
- **Total DHCPv6 Packets Sent** — Specifies the total number of Packets Transmitted.
- **Clear** — Resets the interface packet counters.

Displaying DHCPv6 Statistics

1. Open the **DHCPv6 Statistics** page.
2. Select the interface to be displayed from the Interface drop-down menu.
DHCPv6 statistics display for the selected interface.

Displaying DHCPv6 Statistics Using CLI Commands

For information about the CLI commands that perform this function, see the following chapter in the *CLI Reference Guide*:

- DHCPv6 Commands

The following table summarizes the equivalent CLI commands for this feature.

Table 10-12. DHCPv6 Statistics Commands

CLI Command	Description
show ipv6 dhcp statistics	Displays the DHCPv6 server name and status.
clear ipv6 dhcp	Clears DHCPv6 statistics for all interfaces or for a specific interface.

OSPFv3

OSPFv3 is the Open Shortest Path First routing protocol for IPv6. It is similar to OSPFv2 in its concept of a link state database, intra/inter area, and AS external routes and virtual links. It differs from its IPv4 counterpart in a number of respects, including the following: peering is done through link-local addresses; the protocol is link rather than network centric; and addressing semantics have been moved to leaf LSAs, which eventually allow its use for both IPv4 and IPv6. Point to point links are also supported in order to enable operation over tunnels.

It is possible to enable OSPF and OSPFv3 at the same time. OSPF works with IPv4 and OSPFv3 works with IPv6.

The **OSPFv3** menu page contains links to web pages that define and display OSPFv3 parameters and data. To display this page, click **IPv6** → **OSPFv3** in the tree view.

Following are the web pages accessible from this menu page:

- OSPFv3 Configuration
- OSPFv3 Area Configuration
- OSPFv3 Stub Area Summary
- OSPFv3 Area Range Configuration
- OSPFv3 Interface Configuration
- OSPFv3 Interface Statistics
- OSPFv3 Neighbors
- OSPFv3 Neighbor Table
- OSPFv3 Link State Database
- OSPFv3 Virtual Link Configuration
- OSPFv3 Virtual Link Summary
- OSPFv3 Route Redistribution Configuration
- OSPFv3 Route Redistribution Summary
- Nonstop Forwarding OSPFv3 Graceful Restart

OSPFv3 Configuration

Use the **OSPFv3 Configuration** page to activate and configure OSPFv3 for a switch.

To display the page, click IPv6 → OSPFv3 → Configuration in the tree view.

Figure 10-15. OSPFv3 Configuration

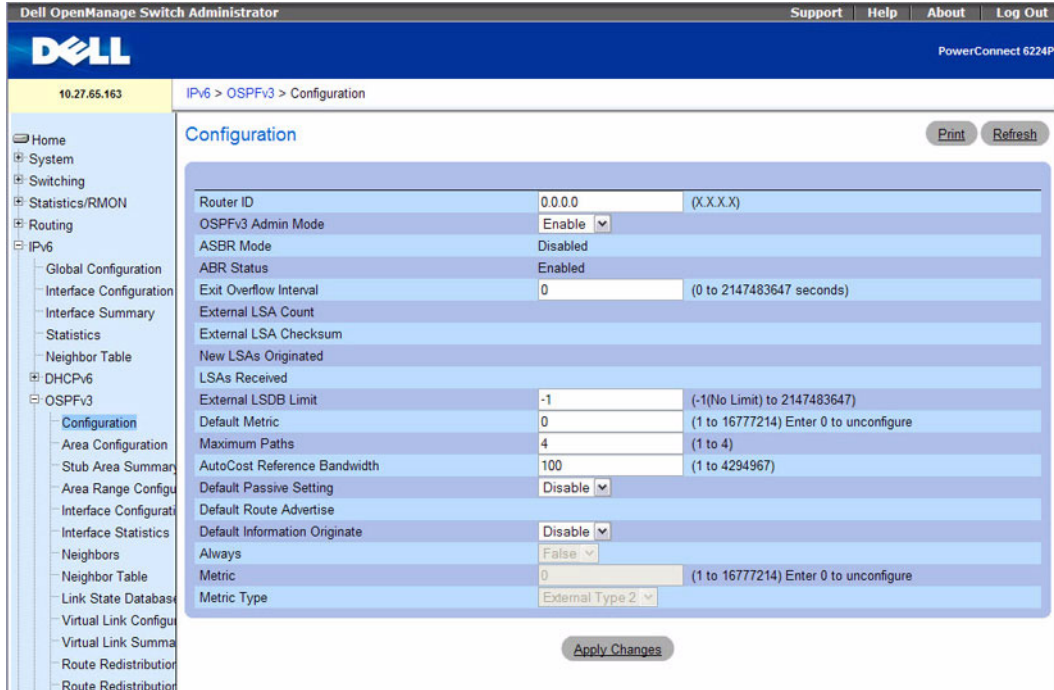

The OSPFv3 Configuration page contains the following fields:

- **Router ID** — The 32-bit integer in dotted decimal format that uniquely identifies the router within the autonomous system (AS). If you want to change the Router ID you must first disable OSPFv3. After you set the new Router ID, you must re-enable OSPFv3 to have the change take effect. The default value is 0.0.0.0, although this is not a valid Router ID, and must be changed before you press the **Apply Changes** button.
- **OSPFv3 Admin Mode** — Select Enable or Disable from the drop-down menu. If you select Enable, OSPFv3 is activated for the switch. The default value is Enable. You must configure a Router ID before OSPFv3 becomes operational. This can also be done by issuing the CLI command, `router id`, in the IPv6 router OSPF mode.
 **NOTE:** Once OSPFv3 is initialized on the router, it remains initialized until the router is reset.
- **ASBR Mode** — Reflects whether the ASBR mode is enabled or disabled. Enable implies that the router is an autonomous system border router. Router automatically becomes an ASBR when it is configured to redistribute routes learned from other protocol.

- **ABR Status** — The values of this are Enable or Disable. The field displays only when a valid configuration exists. Enabled implies that the router is an area border router. Disabled implies that it is not an area border router.
- **Exit Overflow Interval** — Enter the number of seconds that, after entering overflow state, the router should wait before attempting to leave overflow state. This allows the router to again originate non-default AS-external-LSAs. If you enter 0, the router does not leave Overflow State until restarted. The range is 0 to 2147483647 seconds.
- **External LSA Count** — The number of external (LS type 5) LSAs (link state advertisements) in the link state database.
- **External LSA Checksum** — The sum of the LS checksums of the external LSAs (link state advertisements) contained in the link-state database. This sum can be used to determine if there has been a change in a router's link state database, and to compare the link-state databases of two routers.
- **New LSAs Originated** — In any given OSPFv3 area, a router originates several LSAs. Each router originates a router-LSA. If the router is also the Designated Router for any of the area's networks, it originates network-LSAs for those networks. This value represents the number of LSAs originated by this router.
- **LSAs Received** — The number of LSAs (link state advertisements) received that were determined to be new instantiations. This number does not include newer instantiations of self-originated LSAs.
- **External LSDB Limit** — The maximum number of AS-External-LSAs that can be stored in the database. A value of -1 implies there is no limit on the number that can be saved. The valid range of values is -1 to 2147483647.
- **Default Metric** — Sets a default for the metric of redistributed routes. This field displays the default metric if one has already been set or blank if not configured earlier. Valid values are 1 to 16777214.
- **Maximum Paths** — Configure the maximum number of paths that OSPFv3 can report to a given destination. Valid values are 1 to 4.
- **AutoCost Reference Bandwidth** — This field configures the value that OSPFv3 uses in calculating the default metric for an interface. OSPF calculates the link cost of each interface as:

$$\text{Cost} = (\text{Reference Bandwidth in Mbps}) / (\text{Interface Bandwidth}).$$

For example, setting this value to 1000 Mbps would cause all 1-Gbps interfaces to have a default cost of $1000/1000 = 1$. For 100 Mbps interfaces, the default cost would be $1000/100 = 10$.
- **Default Passive Setting** — Select whether OSPFv3 interfaces default to passive mode. In passive mode, interfaces do not send OSPF routing updates. This setting is disabled by default, so that all interfaces default to non-passive mode. If enabled, then all interfaces default to passive mode, and the network manager can selectively enable interfaces to send OSPF routing updates.
- **Default Route Advertise:** Use this section to configure the parameters for Default Route Advertisements into OSPF domain.
- **Default Information Originate** — Enable or disable Default Route Advertise.



NOTE: The values for Always, Metric, and Metric Type can only be configured after Default Information Originate is set to Enable.

If Default Information Originate is set to Enable and values for Always, Metric, and Metric Type are already configured, then setting Default Information Originate back to disable sets the Always, Metric, and Metric Type values to default.

- **Always** — Sets the router advertise ::/0 when set to True.
- **Metric** — Specifies the metric of the default route. Valid values are 0 to 16777214.

Metric Type — Sets the metric type of the default route. Valid values are External Type 1 and External Type 2.

Configuring OSPFv3

1. Open the **OSPFv3 Configuration** page.
2. Modify the fields as needed.
3. Click **Apply Changes**.

The OSPFv3 configuration is saved, and the device is updated.

Configuring OSPFv3 Using CLI Commands

For information about the CLI commands that perform this function, see the following chapter in the *CLI Reference Guide*:

- OSPFv3 Commands

The following table summarizes the equivalent CLI commands for this feature.

Table 10-13. OSPFv3 Global Configuration Commands

CLI Command	Description
default-information originate	Controls the advertisement of default routes.
default-metric	Sets a default for the metric of distributed routes.
distance ospf	Sets the route preference value of OSPF in the router.
enable	Resets the default administrative mode of OSPF in the router (active).
exit-overflow-interval	Configures the exit overflow interval for OSPF.
external-lsdb-limit	Configures the external LSDB limit for OSPF.
ipv6 router ospf	Enters Router OSPFv3 Configuration mode.
maximum-paths	Sets the number of paths that OSPF can report for a given destination.
passive-interface default	Enables the global passive mode by default for all interfaces.
router-id	Sets a 4-digit dotted-decimal number uniquely identifying the Router OSPF ID.
show ipv6 ospf	Displays information relevant to the OSPF router.
show ipv6 ospf abr	Displays the internal OSPFv3 routes to reach Area Border Routers (ABR).
show ipv6 ospf asbr	Displays the internal OSPFv3 routes to reach Autonomous System Boundary Routes (ASBR).
trapflags	Enables OSPF traps

OSPFv3 Area Configuration

Use the **OSPFv3 Area Configuration** page to create and configure an OSPFv3 area.

To display the page, click **IPv6** → **OSPFv3** → **Area Configuration** in the tree view.

Figure 10-16. OSPFv3 Area Configuration

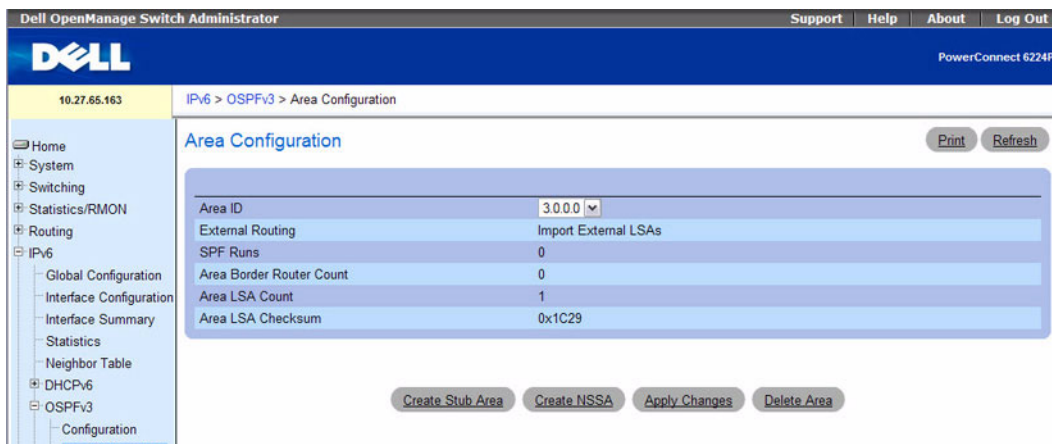

The OSPFv3 Area Configuration page contains the following fields:

- **Area ID** — The OSPFv3 area. An Area ID is a 32-bit integer in dotted decimal format that uniquely identifies the area to which a router interface connects.
- **External Routing** — A definition of the router's capabilities for the area, including whether or not AS-external-LSAs are flooded into/throughout the area. If the area is a stub area, then these are the possible options for which you may configure the external routing capability, otherwise the only option is Import External LSAs.
- **SPF Runs** — The number of times that the intra-area route table has been calculated using this area's link-state database. This is typically done using Dijkstra's algorithm.
- **Area Border Router Count** — The total number of area border routers reachable within this area. This is initially zero, and is calculated in each SPF Pass.
- **Area LSA Count** — The total number of link-state advertisements in this area's link-state database, excluding AS External LSAs.
- **Area LSA Checksum** — The 32-bit unsigned sum of the link-state advertisements' LS checksums contained in this area's link-state database. This sum excludes external (LS type 5) link-state advertisements. The sum can be used to determine if there has been a change in a router's link state database, and to compare the link-state database of two routers. This value is in hexadecimal.

Configuring OSPFv3 Area

1. Open the **OSPFv3 Area Configuration** page.
2. Modify the fields as needed.
3. Click **Apply Changes**.

The configuration is saved and the device is updated.

The web page reappears with **Create Stub Area** and **NSSA Create** buttons.

Figure 10-17. OSPFv3 Area Configuration - Create Stub Area and NSSA Create

The screenshot shows the 'Area Configuration' web page. At the top right are 'Print' and 'Refresh' buttons. The main configuration area is a table with the following fields and values:

Area ID	0.0.0.1
External Routing	Import External LSAs
SPF Runs	0
Area Border Router Count	0
Area LSA Count	0
Area LSA Checksum	0x0

Below the table are four buttons: 'Create Stub Area', 'Create NSSA', 'Apply Changes', and 'Delete Area'.

Configuring OSPFv3 Stub Area

1. Open the OSPFv3 Area Configuration page.
2. Modify the fields as needed.
3. Click **Apply Changes**.

The web page reappears with **Create Stub Area** and **NSSA Create** buttons. See Figure 10-17.

4. Click **Create Stub Area**.

The **Stub Area Information** fields display.

Figure 10-18. OSPFv3 Stub Area Configuration

The screenshot shows the 'Stub Area Information' section of the OSPFv3 Area Configuration web page. It contains the following fields and values:

Import Summary LSAs	Enable
Metric Value	1 (1 to 16777215)

Below the table are three buttons: 'Delete Stub Area', 'Apply Changes', and 'Delete Area'.

5. Complete the remaining fields.
6. Click **Apply Changes**.

The Stub Area information is saved and the device is updated.

Configuring OSPFv3 NSSA Area

1. Open the OSPFv3 Area Configuration page.

2. Modify the fields as needed.

3. Click **Apply Changes**.

The web page reappears with **Create Stub Area** and **NSSA Create** buttons. See Figure 10-17.

4. Click **NSSA Create** on the **OSPFv3 Area Configuration** web page.

The web page reappears showing options for NSSA configuration.

Figure 10-19. OSPFv3 Area Configuration - NSSA

Area Configuration	
Area ID	0.0.0.1
External Routing	Import NSSAs
SPF Runs	0
Area Border Router Count	0
Area LSA Count	0
Area LSA Checksum	0x0

NSSA Specific Information	
Import Summary LSAs	Enable
Default Information Originate	False
Default Metric	10
Default Metric Type	Non-Comparable Cost
Translator Role	Candidate
Translator Stability Interval	40 (0 to 3600)
No-Redistribute Mode	Disable
Translator State	Disabled

Buttons: Delete NSSA, Apply Changes, Delete Area

5. Complete the remaining fields.

6. Click **Apply Changes**.

The NSSA information is saved and the device is updated.

Deleting OSPFv3 Stub Area Information

1. Open the **OSPFv3 Area Configuration** page with configured Stub Area information.

2. Click **Delete Stub Area**.

3. Click **Apply Changes**.

Deleting OSPFv3 NSSA Information

1. Open the **OSPFv3 Area Configuration** page with configured NSSA information.

2. Click **NSSA Delete**.

3. Click **Apply Changes**.

Configuring OSPFv3 Area Using CLI Commands

For information about the CLI commands that perform this function, see the following chapter in the *CLI Reference Guide*:

- OSPFv3 Commands

The following table summarizes the equivalent CLI commands for this feature.

Table 10-14. OSPFv3 Area Configuration Commands

CLI Command	Description
area default-cost	Configures the monetary default cost for the stub area.
area nssa	Configures the specified areaid to function as an NSSA.
area nssa default-info-originate	Configures the metric value and type for the default route advertised into the NSSA.
area nssa no-redistribute	Configures the NSSA ABR so that learned external routes will not be redistributed to the NSSA.
area nssa no-summary	Configures the NSSA so that summary LSAs are not advertised into the NSSA.
area nssa translator-role	Configures the translator role of the NSSA.
area nssa translator-stab-intv	Configures the translator stability interval of the NSSA.
area stub	Creates a stub area for the specified area ID.
area stub no-summary	Disables the import of Summary LSAs for the stub area identified by <i>areaid</i> .
show ipv6 ospf area	Displays information about the area.

OSPFv3 Stub Area Summary

Use the OSPFv3 Stub Area Summary page to display OSPFv3 stub area detail. To display the page, click IPv6 → OSPFv3 → Stub Area Summary in the tree view.

Figure 10-20. OSPFv3 Stub Area Summary

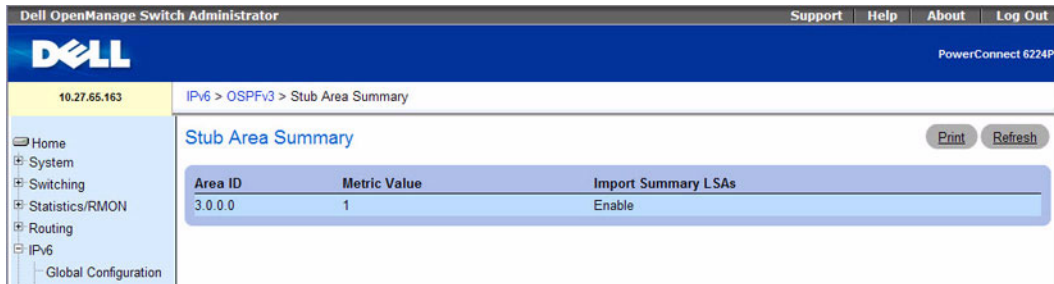

The OSPFv3 Stub Area Summary page displays the following fields:

- **Area ID** — The Area ID of the Stub area.
- **Metric Value** — The metric value applied to the default route advertised into the area.
- **Import Summary LSAs** — Whether the import of Summary LSAs is enabled or disabled.

Displaying the OSPFv3 Stub Area Summary Using CLI Commands

For information about the CLI commands that perform this function, see the following chapter in the *CLI Reference Guide*:

- OSPFv3 Commands

The following table summarizes the equivalent CLI commands for this feature.

Table 10-15. OSPFv3 Stub Area Summary Command

CLI Command	Description
show ipv6 ospf stub table	Displays the OSPF stub table.

OSPFv3 Area Range Configuration

Use the OSPFv3 Area Range Configuration page to configure OSPFv3 area ranges.

To display the page, click IPv6 → OSPFv3 → Area Range Configuration in the tree view.

Figure 10-21. OSPFv3 Area Range Configuration

The screenshot shows the Dell OpenManage Switch Administrator interface. The top navigation bar includes 'Support', 'Help', 'About', and 'Log Out'. The main header displays the Dell logo and 'PowerConnect 6224P'. The left sidebar shows a tree view with 'IPv6' expanded to 'OSPFv3'. The main content area is titled 'Area Range Configuration' and contains the following fields:

Area ID	IPv6 Prefix/Prefix Length	LSDB Type	Advertisement	Create New Area Range
0.0.0		Network Summary	Enable	<input type="checkbox"/>

Below the configuration fields is a table with the following columns: Area ID, IPv6 Prefix/Prefix Length, LSDB Type, Advertisement, and Delete. An 'Apply Changes' button is located at the bottom of the configuration area.

The OSPFv3 Area Range Configuration page contains the following fields:

- **Area ID** — Selects the area for which data is to be configured.
- **IPv6 Prefix/Prefix Length** — Enter the IPv6 Prefix/Prefix Length for the address range for the selected area.
- **LSDB Type** — Select the type of Link Advertisement associated with the specified area and address range. The default type is Network Summary.
- **Advertisement** — Select Enable or Disable from the drop-down menu. If you selected Enable, the address range is advertised outside the area through a Network Summary LSA. The default is Enable.
- **Create New Area Range** — Click this check box to create a new OSPFv3 area range using the values you specified.
- **Area ID** — The OSPFv3 area.
- **IPv6 Prefix** — The IPv6 Prefix of an address range for the area.
- **LSDB Type** — The Link Advertisement type for the address range and area.
- **Advertisement** — The Advertisement mode for the address range and area.
- **Delete** — Click this check box to delete the specified OSPFv3 area range.

Configuring OSPFv3 Area Range

1. Open the OSPFv3 Area Range Configuration page.
2. Modify the fields as needed.
3. Click **Apply Changes**.

The OSPFv3 area range is saved, and the device is updated.

Configuring OSPFv3 Area Range Using CLI Commands

For information about the CLI commands that perform this function, see the following chapter in the *CLI Reference Guide*:

- OSPFv3 Commands

The following table summarizes the equivalent CLI commands for this feature.

Table 10-16. OSPFv3 Area Range Command

CLI Command	Description
area range	Creates an area range for a specified NSSA.
show ipv6 ospf range	Displays information about the area ranges for the specified area identifier.

OSPFv3 Interface Configuration

Use the **OSPFv3 Interface Configuration** page to create and configure OSPFv3 interfaces. This page has been updated to include the **Passive Mode** field.

To display the page, click **IPv6** → **OSPFv3** → **Interface Configuration** in the tree view.

Figure 10-22. OSPFv3 Interface Configuration

The screenshot shows the Dell OpenManage Switch Administrator interface. The top navigation bar includes 'Support', 'Help', 'About', and 'Log Out'. The main header displays the Dell logo and 'PowerConnect 6224P'. The breadcrumb path is 'IPv6 > OSPFv3 > Interface Configuration'. The left sidebar shows a tree view with 'OSPFv3' expanded to 'Interface Configuration'. The main content area is titled 'Interface Configuration' and contains a form for configuring the 'vian111' interface. The form includes fields for 'Interface', 'IPv6 Address', 'OSPFv3 Admin Mode' (set to 'Disable'), 'OSPFv3 Area ID' (0.0.0.0), 'Router Priority' (1), 'Retransmit Interval' (5), 'Hello Interval' (10), 'Dead Interval' (40), 'LSA Ack Interval' (1), 'Interface Delay Interval' (1), 'MTU Ignore' (Disable), 'Passive Mode' (Disable), 'Interface Type' (Broadcast), 'State', 'Designated Router', 'Backup Designated Router', 'Number of Link Events', and 'Metric Cost' (10). 'Print' and 'Refresh' buttons are in the top right, and an 'Apply Changes' button is at the bottom.

Field	Value	Range/Options
Interface	vian111	
IPv6 Address		
OSPFv3 Admin Mode	Disable	
OSPFv3 Area ID	0.0.0.0	(X.X.X.X)
Router Priority	1	(0 to 255)
Retransmit Interval	5	(0 to 3600 seconds)
Hello Interval	10	(1 to 65535 seconds)
Dead Interval	40	(1 to 65535 seconds)
LSA Ack Interval	1	(seconds)
Interface Delay Interval	1	(1 to 3600 seconds)
MTU Ignore	Disable	
Passive Mode	Disable	
Interface Type	Broadcast	
State		
Designated Router		
Backup Designated Router		
Number of Link Events		
Metric Cost	10	(1 to 65535)

The **OSPFv3 Interface Configuration** page contains the following fields:

- **Interface** — Select the interface for which data is to be displayed or configured.
- **IPv6 Address** — The IPv6 address of the interface.
- **OSPFv3 Admin Mode** — You may select **Enable** or **Disable** from the drop-down menu. The default value is **Disable**. You can configure OSPFv3 parameters without enabling OSPFv3 Admin Mode, but they have no effect until you enable Admin Mode. The following information is displayed only if the Admin Mode is enabled: **State**, **Designated Router**, **Backup Designated Router**, **Number of Link Events**, **LSA Ack Interval**, and **Metric Cost**. For OSPFv3 to be fully functional, the interface must have a valid IPv6 Prefix/Prefix Length. This can be done through the CLI using the `ipv6 address` command in the interface configuration mode.



NOTE: Once OSPFv3 is initialized on the router, it remains initialized until the router is reset.

- **OSPFv3 Area ID** — Enter the 32-bit integer in dotted decimal format that uniquely identifies the OSPFv3 area to which the selected router interface connects. If you assign an Area ID which does not exist, the area is created with default values.
- **Router Priority** — Enter the OSPFv3 priority for the selected interface. The priority of an interface is specified as an integer from 0 to 255. The default is 1, which is the highest router priority. A value of 0 indicates that the router is not eligible to become the designated router on this network.
- **Retransmit Interval** — Enter the OSPFv3 retransmit interval for the specified interface. This is the number of seconds between link-state advertisements for adjacencies belonging to this router interface. This value is also used when retransmitting database descriptions and link-state request packets. Valid values range from 0 to 3600 seconds (1 hour). The default is 5 seconds.
- **Hello Interval** — Enter the OSPFv3 hello interval for the specified interface in seconds. This parameter must be the same for all routers attached to a network. Valid values range from 1 to 65,535. The default is 10 seconds.
- **Dead Interval** — Enter the OSPFv3 dead interval for the specified interface in seconds. This specifies how long a router waits to see a neighbor router's Hello packets before declaring that the router is down. This parameter must be the same for all routers attached to a network. This value should be a multiple of the Hello Interval (for example 4). Valid values range from 1 to 165535. The default is 40.
- **LSA Ack Interval** — Displays the number of seconds between LSA Acknowledgment packet transmissions, which must be less than the Retransmit Interval.
- **Interface Delay Interval** — Enter the OSPFv3 Transit Delay for the specified interface. This specifies the estimated number of seconds it takes to transmit a link state update packet over the selected interface. Valid values range from 1 to 3600 seconds (1 hour). The default value is 1 second.
- **MTU Ignore** — Disables OSPFv3 MTU mismatch detection on receiving packets. The default value is Disable.
- **Passive Mode** — When you enable passive mode on an OSPFv3 interface, you disable sending OSPFv3 routing updates on the interface. An OSPFv3 adjacency will not be formed on a passive interface. Interfaces are not passive by default.
- **Interface Type** — Enter the interface type, which can either be set to broadcast mode or point to point mode. The default interface type is broadcast.
- **State** — The current state of the selected router interface. The State is displayed only if the OSPFv3 admin mode is enabled. This field can have one of the following values:
 - **Down** — This is the initial interface state. In this state, the lower-level protocols have indicated that the interface is unusable. In this state, interface parameters are set to their initial values. All interface timers are disabled, and there are no adjacencies associated with the interface.
 - **Loopback** — In this state, the router's interface to the network is looped back either in hardware or software. The interface is unavailable for regular data traffic. However, it may still be desirable to gain information on the quality of this interface, either through sending ICMP pings to the

interface or through something like a bit error test. For this reason, IP packets may still be addressed to an interface in Loopback state. To facilitate this, such interfaces are advertised in router-LSAs as single host routes, whose destination is the IP interface address.

- **Waiting** — The router is trying to determine the identity of the (Backup) Designated Router for the network by monitoring received Hello Packets. The router is not allowed to elect a Backup Designated Router or a Designated Router until it transitions out of Waiting state. This prevents unnecessary changes of (Backup) Designated Router.
- **Designated Router** — This router is itself the Designated Router on the attached network. Adjacencies are established to all other routers attached to the network. The router must also originate a network-LSA for the network node. The network-LSA contains links to all routers (including the Designated Router itself) attached to the network.
- **Backup Designated Router** — This router is itself the Backup Designated Router on the attached network. It is promoted to Designated Router if the present Designated Router fails. The router establishes adjacencies to all other routers attached to the network. The Backup Designated Router performs slightly different functions during the Flooding Procedure, as compared to the Designated Router.
- **Other Designated Router** — The interface is connected to a broadcast or NBMA network on which other routers have been selected to be the Designated Router and Backup Designated Router either. The router attempts to form adjacencies to both the Designated Router and the Backup Designated Router.
- **Metric Cost** — Enter the value on this interface for the cost TOS (type of service). The range for the metric cost is between 1 and 65,535. Metric Cost is only configurable if OSPFv3 is initialized on the interface.

Configuring an OSPFv3 Interface

1. Open the **OSPFv3 Interface Configuration** page.
2. Select the Interface on which you want OSPFv3 configured.
3. Modify the remaining fields as needed.
4. Click **Apply Changes**.

The interface is configured for OSPFv3, and the device is updated.

Configuring an OSPFv3 Interface Using CLI Commands

For information about the CLI commands that perform this function, see the following chapter in the *CLI Reference Guide*:

- OSPFv3 Commands

The following table summarizes the equivalent CLI commands for this feature.

Table 10-17. OSPFv3 Interface Commands

CLI Command	Description
ipv6 ospf	Enables OSPF on a router interface or loopback interface.
ipv6 ospf areaid	Sets the OSPF area to which the specified router interface belongs.
ipv6 ospf cost	Configures the cost on an OSPF interface.
ipv6 ospf dead-interval	Sets the OSPF dead interval for the specified interface.
ipv6 ospf hello-interval	Sets the OSPF hello interval for the specified interface.
ipv6 ospf mtu-ignore	Disables OSPF maximum transmission unit (MTU) mismatch detection.
ipv6 ospf network	Changes the default OSPF network type for the interface.
ipv6 ospf priority	Sets the OSPF priority for the specified router interface.
ipv6 ospf retransmit-interval	Sets the OSPF retransmit interval for the specified interface.
ipv6 ospf transmit-delay	Sets the OSPF Transmit Delay for the specified interface.
passive-interface	Sets the interface or tunnel as passive.
show ipv6 ospf interface	Displays the information for the IFO object or virtual interface tables.
show ipv6 ospf interface brief	Displays brief information for the IFO object or virtual interface tables.
show ipv6 ospf interface vlan	Displays OSPFv3 configuration and status information for a specific vlan

OSPFv3 Interface Statistics

Use the **OSPFv3 Interface Statistics** page to display OSPFv3 interface statistics. Information is only displayed if OSPF is enabled. Several fields have been added to this page.

To display the page, click **IPv6** → **OSPFv3** → **Interface Statistics** in the tree view.

Figure 10-23. OSPFv3 Interface Statistics

The screenshot shows the Dell OpenManage Switch Administrator interface. The main content area displays the 'Interface Statistics' page for the selected interface 'vlan123'. The page includes a navigation menu on the left and a table of statistics on the right.

Interface	vlan123
OSPFv3 Area ID	3.0.0.0
Area Border Router Count	0
AS Border Router Count	0
Area LSA Count	2
IPv6 Address	FE80::2FC:E3FF:FE90:411
Interface Events	2
Virtual Events	0
Neighbor Events	0
External LSA Count	0
Sent Packets	16
Received Packets	0
Discards	0
Bad Version	0
Virtual Link Not Found	0
Area Mismatch	0
Invalid Destination Address	0
No Neighbor at Source Address	0
Invalid OSPF Packet Type	0
Hellos Ignored	0
Hellos Sent	16
Hellos Received	0
DD Packets Sent	0
DD Packets Received	0
LS Requests Sent	0
LS Requests Received	0
LS Updates Sent	0
LS Updates Received	0
LS Acknowledgements Sent	0
LS Acknowledgements Received	0

The OSPFv3 Interface Statistics page displays the following fields:

- **Interface** — Select the interface for which data is to be displayed.
- **OSPFv3 Area ID** — The OSPF area to which the selected router interface belongs. An OSPF Area ID is a 32-bit integer in dotted decimal format that uniquely identifies the area to which the interface connects.
- **Area Border Router Count** — The total number of area border routers reachable within this area. This is initially zero, and is calculated in each SPF Pass.
- **AS Border Router Count** — The total number of Autonomous System border routers reachable within this area. This is initially zero, and is calculated in each SPF Pass.
- **Area LSA Count** — The total number of link-state advertisements in this area's link-state database, excluding AS External LSAs.
- **IPv6 Address** - The IP address of the interface.

- **Interface Events** — The number of times the specified OSPF interface has changed its state, or an error has occurred.
- **Virtual Events** — The number of state changes or errors that have occurred on this virtual link.
- **Neighbor Events** — The number of times this neighbor relationship has changed state, or an error has occurred.
- **External LSA Count** — The number of external (LS type 5) link-state advertisements in the link-state database.
- **Sent packets** — The number of OSPFv3 packets transmitted on the interface.
- **Received packets** — The number of valid OSPFv3 packets received on the interface.
- **Discards** — The number of received OSPFv3 packets discarded because of an error in the packet or an error in processing the packet.
- **Bad Version** — The number of received OSPFv3 packets whose version field in the OSPFv3 header does not match the version of the OSPFv3 process handling the packet.
- **Virtual Link Not Found** — The number of received OSPFv3 packets discarded where the ingress interface is in a non-backbone area and the OSPFv3 header identifies the packet as belonging to the backbone, but OSPFv3 does not have a virtual link to the packet's sender.
- **Area Mismatch** — The number of OSPFv3 packets discarded because the area ID in the OSPFv3 header is not the area ID configured on the ingress interface.
- **Invalid Destination Address** — The number of OSPFv3 packets discarded because the packet's destination IP address is not the address of the ingress interface and is not the AllDrRouters or AllSpfRouters multicast addresses.
- **No Neighbor at Source Address** — The number of OSPFv3 packets dropped because the sender is not an existing neighbor or the sender's IP address does not match the previously recorded IP address for that neighbor.
- **Invalid OSPF Packet Type** — The number of OSPFv3 packets discarded because the packet type field in the OSPFv3 header is not a known type.
- **Hellos Ignored** — The number of received Hello packets that were ignored by this router from the new neighbors after the limit has been reached for the number of neighbors on an interface or on the system as a whole.
- **Hellos Sent** — The number of Hello packets sent on this interface by this router.
- **Hellos Received** — The number of Hello packets received on this interface by this router.
- **DD Packets Sent** — The number of Database Description packets sent on this interface by this router.
- **DD Packets Received** — The number of Database Description packets received on this interface by this router.
- **LS Requests Sent** — The number of LS Requests sent on this interface by this router.
- **LS Requests Received** — The number of LS Requests received on this interface by this router.
- **LS Updates Sent** — The number of LS updates sent on this interface by this router.

- **LS Updates Received** — The number of LS updates received on this interface by this router.
- **LS Acknowledgements Sent** — The number of LS acknowledgements sent on this interface by this router.
- **LS Acknowledgements Received** — The number of LS acknowledgements received on this interface by this router.

Displaying OSPFv3 Interface Statistics

1. Open the **OSPFv3 Interface Statistics** page.
2. Select the interface to display from the **Interface** drop-down menu.
Statistics for the interface display.

Displaying OSPFv3 Interface Statistics Using CLI Commands

For information about the CLI commands that perform this function, see the following chapter in the *CLI Reference Guide*:

- OSPFv3 Commands

The following table summarizes the equivalent CLI commands for this feature.

Table 10-18. OSPFv3 Interface Statistics Commands

CLI Command	Description
show ipv6 ospf interface stats	Displays the statistics for a specific interface.

OSPFv3 Neighbors

Use the **OSPFv3 Neighbors** page to display the OSPF neighbor configuration for a selected neighbor ID. When a particular neighbor ID is specified, detailed information about that neighbor is given. Neighbor information only displays if OSPF is enabled and the interface has a neighbor. The IP address is the IP address of the neighbor.

To display the page, click **IPv6** → **OSPFv3** → **Neighbors** in the tree view.

Figure 10-24. OSPFv3 Neighbors



The OSPFv3 Neighbors page contains the following fields:

- **Interface** — Selects the interface for which data is to be displayed or configured.
- **Neighbor Router ID** — Selects the IP Address of the neighbor for which data is to be displayed.
- **Area ID** — A 32-bit integer in dotted decimal format that identifies the neighbor router.
- **Options** — The optional OSPF capabilities supported by the neighbor. The neighbor's optional OSPF capabilities are also listed in its Hello packets. This enables received Hello Packets to be rejected (i.e., neighbor relationships do not even start to form) if there is a mismatch in certain crucial OSPF capabilities.
- **Router Priority** — Displays the OSPF priority for the specified neighbor. The priority of a neighbor is a priority integer from 0 to 255. A value of 0 indicates that the router is not eligible to become the designated router on this network.
- **Dead Timer Due in (secs)** — If Hello packets do not arrive, specifies amount of time elapsed before neighbor is declared dead.
- **State** — The state of a neighbor can be the following:
 - **Down** — This is the initial state of a neighbor conversation. It indicates that there is no recent information received from the neighbor. On NBMA networks, Hello packets may still be sent to Down neighbors, although at a reduced frequency.

- **Attempt** — This state is only valid for neighbors attached to NBMA networks. It indicates that no recent information has been received from the neighbor, but that a more concerted effort should be made to contact the neighbor. This is done by sending the neighbor Hello packets at intervals of Hello Interval.
- **Init** — In this state, a Hello packet has recently been seen from the neighbor. However, bidirectional communication has not yet been established with the neighbor (i.e., the router itself did not appear in the neighbor's Hello packet). All neighbors in this state (or greater) are listed in the Hello packets sent from the associated interface.
- **2-Way** — In this state, communication between the two routers is bidirectional. This has been assured by the operation of the Hello Protocol. This is the most advanced state short of beginning adjacency establishment. The (Backup) Designated Router is selected from the set of neighbors in state 2-Way or greater.
- **Exchange Start** — This is the first step in creating an adjacency between the two neighboring routers. The goal of this step is to decide which router is the master, and to decide upon the initial DD sequence number. Neighbor conversations in this state or greater are called adjacencies.
- **Exchange** — In this state the router is describing its entire link state database by sending Database Description packets to the neighbor. In this state, Link State Request Packets may also be sent asking for the neighbor's more recent LSAs. All adjacencies in Exchange state or greater are used by the flooding procedure. These adjacencies are fully capable of transmitting and receiving all types of OSPF routing protocol packets.
- **Loading** — In this state, Link State Request packets are sent to the neighbor asking for the more recent LSAs that have been discovered (but not yet received) in the Exchange state.
- **Full** — In this state, the neighboring routers are fully adjacent. These adjacencies now appears in router-LSAs and network-LSAs.
- **Events** — The number of times this neighbor relationship has changed state, or an error has occurred.
- **Retransmission Queue Length** — The current length of the retransmission queue.

Displaying OSPFv3 Neighbors

1. Open the OSPFv3 Neighbors page.
2. Select the interface to display from the **Interface** drop-down menu.
3. Select the **Neighbor Router ID** to display.

Statistics for the selected interface **Neighbor ID** display.

Displaying OSPFv3 Neighbors Using CLI Commands

For information about the CLI commands that perform this function, see the following chapter in the *CLI Reference Guide*:

- OSPFv3 Commands

The following table summarizes the equivalent CLI commands for this feature.

Table 10-19. OSPFv3 Neighbor Command

CLI Command	Description
show ipv6 ospf neighbor	Displays information about OSPF neighbors.

OSPFv3 Neighbor Table

Use the **OSPFv3 Neighbor Table** page to display the OSPF neighbor table list. When a particular neighbor ID is specified, detailed information about a neighbor is given. The neighbor table is only displayed if OSPF is enabled.

To display the page, click **IPv6** → **OSPFv3** → **Neighbor Table** in the tree view.

Figure 10-25. OSPFv3 Neighbor Table

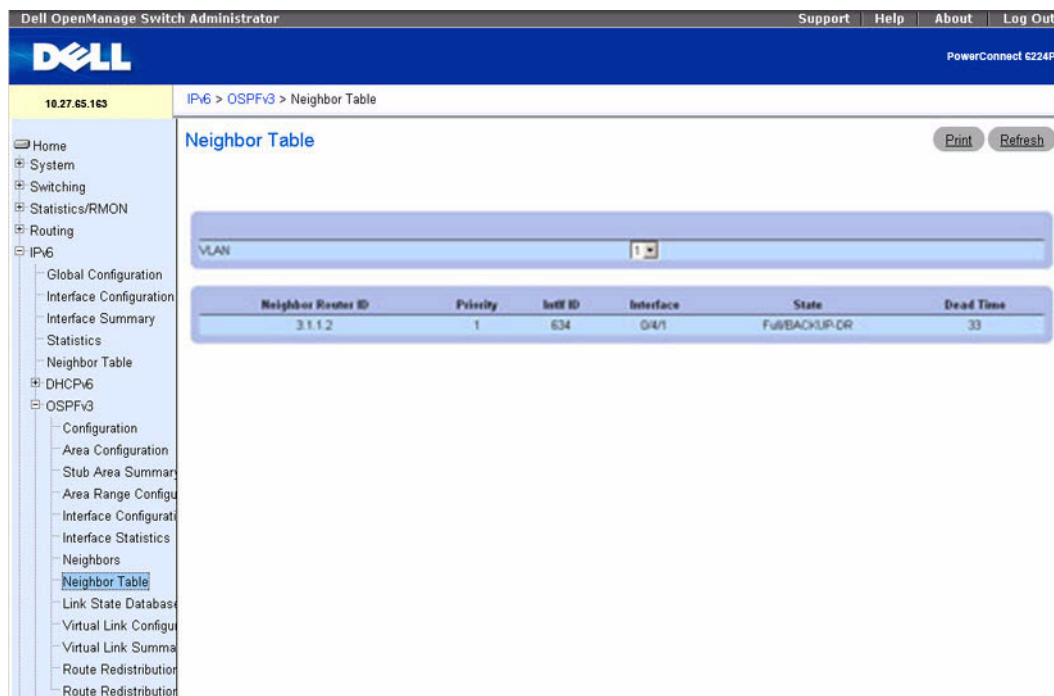

The **OSPFv3 Neighbor Table** page displays the following fields:

- **Interface** — Selects the interface for which data is to be displayed or configured.
- **Neighbor Router ID** — A 32-bit integer in dotted decimal format representing the neighbor interface.
- **Priority** — The priority of this neighbor in the designated router election algorithm. A value of 0 indicates that the neighbor is not eligible to become the designated router on this network.

- **IntfID** — The Interface ID that the neighbor advertises in its Hello packets on this link.
- **Interface** — The slot/port that identifies the neighbor interface index.
- **State** — State of the relationship with this neighbor.
- **Dead Time** — Number of seconds since last Hello was received from adjacent neighbors. Set this value to 0 for neighbors in a state less than or equal to Init.

Displaying the OSPFv3 Neighbor Table

1. Open the **OSPFv3 Neighbor Table** page.
2. Select the interface to display from the **Interface** drop-down menu.
The OSPF neighbor table for the selected interface displays.

Displaying the OSPFv3 Neighbor Table Using CLI Commands

For information about the CLI commands that perform this function, see the following chapter in the *CLI Reference Guide*:

- OSPFv3 Commands

The following table summarizes the equivalent CLI commands for this feature.

Table 10-20. OSPFv3 Neighbor Table Commands

CLI Command	Description
show ipv6 ospf neighbor	Displays information about OSPF neighbors.

OSPFv3 Link State Database

Use the **OSPFv3 Link State Database** page to display the link state and external LSA databases. The **OSPFv3 Link State Database** page has been updated to display external LSDB table information in addition to OSPFv3 link state information.

To display the page, click **IPv6** → **OSPFv3** → **Link State Database** in the tree view.

Figure 10-26. OSPFv3 Link State Database

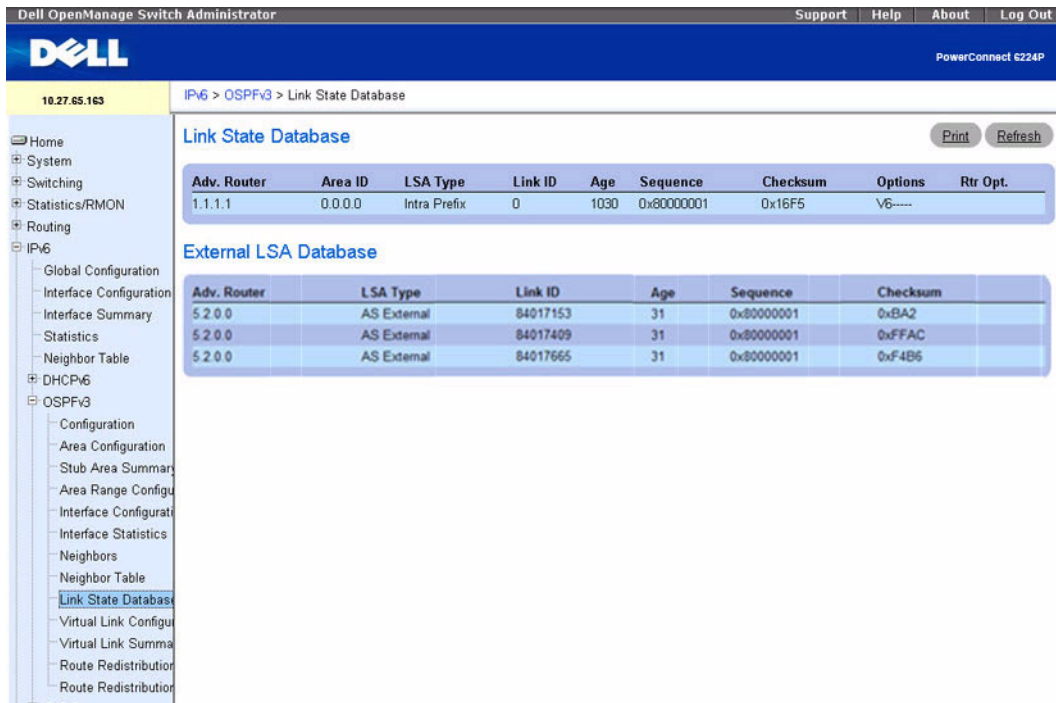

The OSPFv3 Link State Database page displays the following fields:

- **Adv. Router** — The 32-bit integer in dotted decimal format that uniquely identifies the router within the autonomous system (AS). The Router ID is set on the OSPFv3 Configuration page.
- **Area ID** — The ID of an OSPF area to which one of the router interfaces is connected. An Area ID is a 32-bit integer in dotted decimal format that uniquely identifies the area to which an interface is connected.
- **LSA Type** — The format and function of the link state advertisement. The types, which are defined in RFC 2740 section A.4, can be any of the following:
 - Router-LSA
 - Network-LSA
 - Inter-Area-Prefix-LSA
 - Inter-Area-Router-LSA
 - AS-External-LSA
 - Type-7-LSA
 - Link-LSA

- Intra-Area-Prefix-LSA
- **Link ID** — The Link State ID identifies the piece of the routing domain that is being described by the advertisement. The value of the LS ID depends on the advertisement's LS type.
- **Age** — The time since the link state advertisement was first originated, in seconds.
- **Sequence** — The sequence number field is a signed 32-bit integer. It is used to detect old and duplicate link state advertisements. The larger the sequence number, the more recent the advertisement.
- **Checksum** — The checksum is used to detect data corruption of an advertisement. This corruption can occur while an advertisement is being flooded, or while it is being held in a router's memory. This field is the checksum of the complete contents of the advertisement, except the LS age field.
- **Options** — The Options field in the link state advertisement header indicates which optional capabilities are associated with the advertisement. The options are:
 - V6 — When clear, the link is excluded from IPv6 routing calculations.
 - E — Describes how AS-external-LSAs are flooded
 - MC — Describes whether IP multicast datagrams are forwarded according to the specifications in
 - N — Describes how Type-7 LSAs are handled
 - R — Shows whether the originator is an active router. The R option is the router bit, and when it is clear, routes that pass through the advertising node cannot be computed.
 - DC — Describes how the system handles demand circuits.
- **Rtr Opt.** — Shows router-specific options.

Displaying OSPFv3 Link State Database Using CLI Commands

For information about the CLI commands that perform this function, see the following chapter in the *CLI Reference Guide*:

- OSPFv3 Commands

The following table summarizes the equivalent CLI commands for this feature.

Table 10-21. OSPFv3 Link State Database Commands

CLI Command	Description
show ipv6 ospf database	Displays information about the link state database when OSPFv3 is enabled.
show ipv6 ospf database database-summary	Displays the number of each type of LSA in the database and the total number of LSAs in the database.

OSPFv3 Virtual Link Configuration

Use the [OSPFv3 Virtual Link Configuration](#) page to define a new or configure an existing virtual link. To display this page, a valid OSPFv3 area must be defined through the [OSPFv3 Area Configuration](#) page.

To display the page, click IPv6 → OSPFv3 → Virtual Link Configuration in the tree view.

Figure 10-27. OSPFv3 Virtual Link Configuration

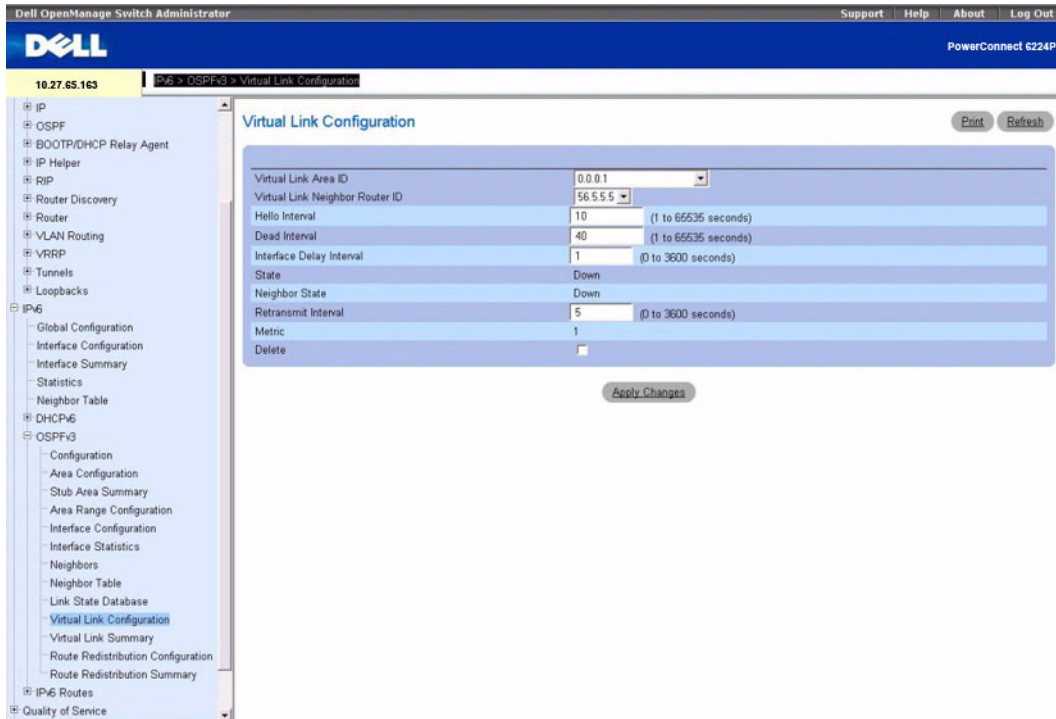

The OSPFv3 Virtual Link Configuration page contains the following fields:

- **Create New Virtual Link** — Select this option from the drop-down menu to define a new virtual link. The area portion of the virtual link identification is fixed: you are prompted to enter the Neighbor Router ID on a new screen.
- **Virtual Link (Area ID - Neighbor Router ID)** — Select the virtual link for which you want to display or configure data. It consists of the Area ID and Neighbor Router ID.
- **Hello Interval (secs)** — Enter the OSPF hello interval for the specified interface in seconds. This parameter must be the same for all routers attached to a network. Valid values range from 1 to 65,535. The default is 10 seconds.
- **Dead Interval (secs)** — Enter the OSPF dead interval for the specified interface in seconds. This specifies how long a router waits to see a neighbor router's Hello packets before declaring that the router is down. This parameter must be the same for all routers attached to a network. This value should be a multiple of the Hello Interval (for example 4). Valid values range from 1 to 2147483647. The default is 40.

- **Interface Delay Interval (secs)** — Enter the OSPF Transit Delay for the specified interface. This specifies the estimated number of seconds it takes to transmit a link state update packet over the selected interface. Valid values range from 1 to 3600 seconds (1 hour). The default value is 1 second.
- **State** — The current state of the selected Virtual Link. One of:
 - **Down** — This is the initial interface state. In this state, the lower-level protocols have indicated that the interface is unusable. In this state, interface parameters are set to their initial values. All interface timers are disabled, and there are no adjacencies associated with the interface.
 - **Waiting** — The router is trying to determine the identity of the (Backup) Designated Router by monitoring received Hello Packets. The router is not allowed to elect a Backup Designated Router or a Designated Router until it transitions out of Waiting state. This prevents unnecessary changes of (Backup) Designated Router.
 - **Point-to-Point** — The interface is operational, and is connected either to the virtual link. On entering this state the router attempts to form an adjacency with the neighboring router. Hello Packets are sent to the neighbor every HelloInterval seconds.
 - **Designated Router** — This router is itself the Designated Router on the attached network. Adjacencies are established to all other routers attached to the network. The router must also originate a network-LSA for the network node. The network- LSA contains links to all routers (including the Designated Router itself) attached to the network.
 - **Backup Designated Router** — This router is itself the Backup Designated Router on the attached network. It is promoted to Designated Router if the present Designated Router fails. The router establishes adjacencies to all other routers attached to the network. The Backup Designated Router performs slightly different functions during the Flooding Procedure, as compared to the Designated Router.
 - **Other Designated Router** — The interface is connected to a broadcast or NBMA network on which other routers have been selected to be the Designated Router and Backup Designated Router either. The router attempts to form adjacencies to both the Designated Router and the Backup Designated Router.
- **Neighbor State** — The state of the Virtual Neighbor Relationship.
- **Retransmit Interval** — Enter the OSPF retransmit interval for the specified interface. This is the number of seconds between link-state advertisements for adjacencies belonging to this router interface. This value is also used when retransmitting database descriptions and link-state request packets. Valid values range from 1 to 3600 seconds (1 hour). The default is 5 seconds.
- **Metric** — The metric value used by the virtual link.
- **Delete** — Removes the specified virtual link from the router configuration.

Creating a New Virtual Link

1. Open the OSPFv3 Virtual Link Configuration page.
2. Select **Create New Virtual Link** from the drop-down menu to define a new virtual link.
3. Enter the **Neighbor Router ID**.

4. Click Create.

The new link is created, and you are returned to the Virtual Link Configuration page.

Configuring a Virtual Link

1. Open the OSPFv3 Virtual Link Configuration page.
2. Select the virtual link to configure.
3. Modify the remaining fields as needed.
4. Click Apply Changes.
5. The virtual link is configured for OSPFv3, and the device is updated.

Configuring an OSPFv3 Virtual Link using CLI Commands

For information about the CLI commands that perform this function, see the following chapter in the *CLI Reference Guide*:

- OSPFv3 Commands

The following table summarizes the equivalent CLI commands for this feature.

Table 10-22. OSPFv3 Virtual Link Configuration Command

CLI Command	Description
area virtual-link	Creates the OSPF virtual interface for the specified <i>areaid</i> and <i>neighbor</i> .
area virtual-link dead-interval	Configures the dead interval for the OSPF virtual interface on the virtual interface identified by <i>areaid</i> and <i>neighbor</i> .
area virtual-link hello-interval	Configures the hello interval for the OSPF virtual interface on the virtual interface identified by <i>areaid</i> and <i>neighbor</i> .
area virtual-link retransmit-interval	Configures the retransmit interval for the OSPF virtual interface on the virtual interface identified by <i>areaid</i> and <i>neighbor</i> .
area virtual-link transmit-delay	Configures the transmit delay for the OSPF virtual interface on the virtual interface identified by <i>areaid</i> and <i>neighbor</i> .
show ipv6 ospf virtual-link	Displays the OSPF Virtual Interface information for a specific area and neighbor.

OSPFv3 Virtual Link Summary

Use the OSPFv3 Virtual Link Summary page to display virtual link data by Area ID and Neighbor Router ID.

To display the page, click **IPv6** → **OSPFv3** → **Virtual Link Summary** in the tree view.

Figure 10-28. OSPFv3 Virtual Link Summary

The screenshot shows the Dell OpenManage Switch Administrator interface. The top navigation bar includes 'Support', 'Help', 'About', and 'Log Out'. The main content area is titled 'Virtual Link Summary' and contains a table with the following data:

Area ID	Neighbor Router ID	Hello Interval (secs)	Dead Interval (secs)	Retransmit Interval (secs)	Interface Delay Interval (secs)
0.0.0.1	56.5.5.5	10	40	5	1

The OSPFv3 Virtual Link Summary page displays the following fields:

- **Area ID** — The Area ID portion of the virtual link identification for which data is to be displayed. The Area ID and Neighbor Router ID together define a virtual link.
- **Neighbor Router ID** — The neighbor portion of the virtual link identification. Virtual links may be configured between any pair of area border routers having interfaces to a common (non-backbone) area.
- **Hello Interval (secs)** — The OSPF hello interval for the virtual link in units of seconds. The value for hello interval must be the same for all routers attached to a network.
- **Dead Interval (secs)** — The OSPF dead interval for the virtual link in units of seconds. This specifies how long a router waits to see a neighbor router's Hello packets before declaring that the router is down. This parameter must be the same for all routers attached to a common network, and should be a multiple of the Hello Interval (i.e. 4).
- **Retransmit Interval (secs)** — The OSPF retransmit interval for the virtual link in units of seconds. This specifies the time between link-state advertisements for adjacencies belonging to this router interface. This value is also used when retransmitting database descriptions and link-state request packets.

- **Interface Delay Interval (secs)** — The OSPF Transit Delay for the virtual link in units of seconds. It specifies the estimated number of seconds it takes to transmit a link state update packet over this interface.

Displaying OSPFv3 Virtual Link Summary Using CLI Commands

For information about the CLI commands that perform this function, see the following chapter in the *CLI Reference Guide*:

- OSPFv3 Commands

The following table summarizes the equivalent CLI commands for this feature.

Table 10-23. OSPFv3 Virtual Link Summary Commands

CLI Command	Description
show ipv6 ospf virtual-link brief	Displays the OSPFv3 Virtual Interface information for all areas in the system.

OSPFv3 Route Redistribution Configuration

Use the OSPFv3 Route Redistribution Configuration page to configure route redistribution.

To display the page, click IPv6 → OSPFv3 → Route Redistribution Configuration in the tree view.

Figure 10-29. OSPFv3 Route Redistribution Configuration

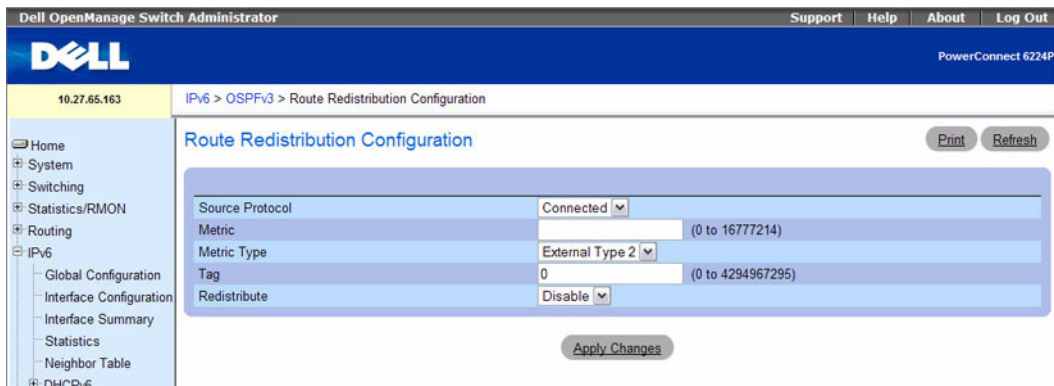

The OSPFv3 Route Redistribution Configuration page contains the following fields:

- **Source Protocol** — Select the type of source routes to configure for redistribution by OSPF. Valid values are Static and Connected.
- **Metric** — Sets the metric value to be used as the metric of redistributed routes. This field displays the metric if the source was pre-configured and can be modified. Valid values are 0 to 16777214.
- **Metric Type** — Sets the OSPF metric type of redistributed routes.

- **Tag** — Sets the tag field in routes redistributed. This field displays the tag if the source was pre-configured, otherwise 0 is displayed. Valid values are 0 to 4294967295.
- **Redistribute** — Enables or disables the redistribution for the selected source protocol. This field has to be enabled in order to be able to configure any of the route redistribution attributes.

Configuring OSPFv3 Route Redistribution

1. Open the **OSPFv3 Route Redistribution Configuration** page.
2. Specify **Create** to set up a new configured source. Specify **Connected** or **Static** to modify an existing configured source.
3. Set up or modify the remaining fields as needed.
4. Click **Apply Changes**.

The selected route redistribution is configured for OSPFv3, and the device is updated.

Configuring OSPFv3 Route Redistribution Using CLI Commands

For information about the CLI commands that perform this function, see the following chapter in the *CLI Reference Guide*:

- OSPFv3 Commands

The following table summarizes the equivalent CLI commands for this feature.

Table 10-24. OSPFv3 Route Redistribution Commands

CLI Command	Description
redistribute	Configures the OSPFv3 protocol to allow redistribution of routes from the specified source protocol/routers.
distribute-list out	Specifies the access list to filter routes received from the source protocol.

OSPFv3 Route Redistribution Summary

Use the **OSPFv3 Route Redistribution Summary** page to display route redistribution settings by source.

To display the page, click **IPv6** → **OSPFv3** → **Route Redistribution Summary** in the tree view.

Figure 10-30. OSPFv3 Route Redistribution Summary

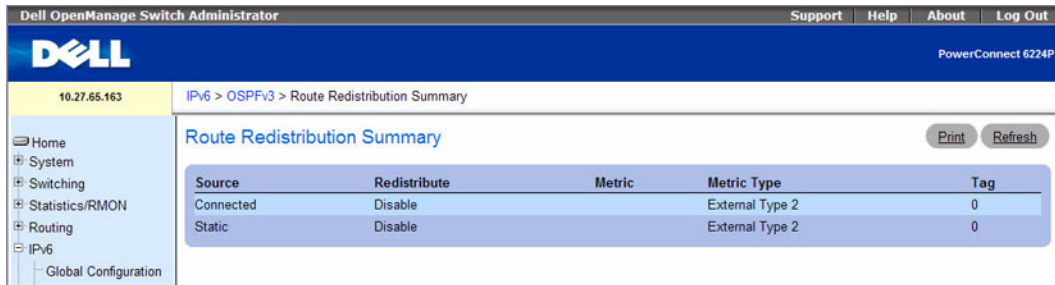

The OSPFv3 Route Redistribution Summary page displays the following fields:

- **Source** — The Source Route to be Redistributed by OSPF.
- **Redistribute** — Specify whether to allow the routes learned through this protocol to be redistributed.
- **Metric** — The Metric of redistributed routes for the given Source Route. Displays nothing when not configured.
- **Metric Type** — The OSPF metric type of redistributed routes.
- **Tag** — The tag field in routes redistributed. This field displays the tag if the source was pre-configured, otherwise 0.

Displaying OSPFv3 Route Redistribution Summary Using CLI Commands

For information about the CLI commands that perform this function, see the following chapter in the *CLI Reference Guide*:

- OSPFv3 Commands

The following table summarizes the equivalent CLI commands for this feature.

Table 10-25. OSPFv3 Route Redistribution Summary Command

CLI Command	Description
show ipv6 ospf	Displays OSPFv3 route redistribution summary data.

Nonstop Forwarding OSPFv3 Graceful Restart

The OSPFv3 protocol can be configured to perform a “graceful restart” in conjunction with the nonstop forwarding feature (see “Nonstop Forwarding” on page 258) for stacked switches. When OSPFv3 graceful restart is enabled and the management unit in a stack fails, the hardware can continue to forward packets using OSPFv3 routes while a backup switch takes over management unit responsibility.

Graceful restart uses the concept of “helpful neighbors”. A fully adjacent router enters helper mode when it receives a link state announcement (LSA) from the restarting management unit indicating its intention of performing a graceful restart. In helper mode, a switch continues to advertise to the rest of the network that they have full adjacencies with the restarting router, thereby avoiding announcement of a topology change and the potential for flooding of LSAs and shortest-path-first (SPF) runs (which determine OSPFv3 routes). Helpful neighbors continue to forward packets through the restarting router. The restarting router relearns the network topology from its helpful neighbors.

Graceful restart can be enabled for either planned or unplanned restarts, or both. A planned restart is initiated by the operator (see “Enabling and Disabling NSF” on page 258). The operator may initiate a failover in order to take the management unit out of service (for example, to address a partial hardware failure), to correct faulty system behavior which cannot be corrected through less severe management actions, or other reasons. An unplanned restart is an unexpected failover caused by a fatal hardware failure of the management unit or a software hang or crash on the management unit.

To configure the OSPFv3 graceful restart feature, click **IPv6** → **OSPFv3** → **NSF OSPFv3 Summary** in the navigation tree.

Figure 10-31. NSF OSPFv3 Summary

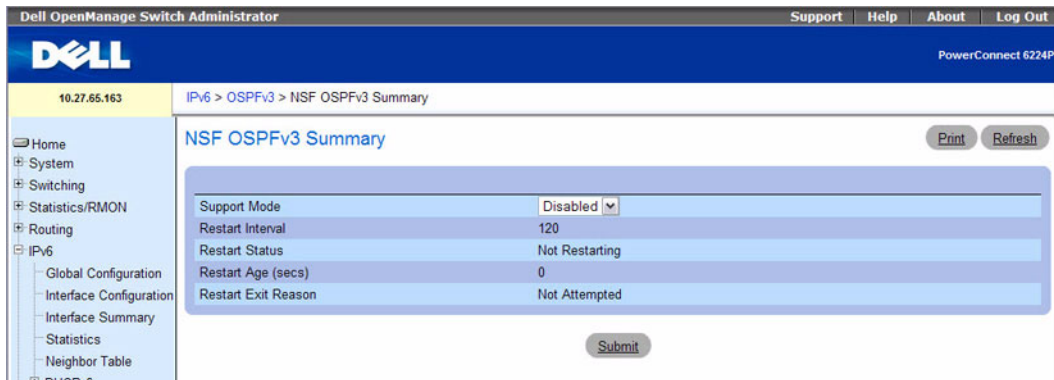

- Support Mode — Enables or disables OSPFv3 to perform graceful restarts. The following options are available:
 - Planned—OSPFv3 will perform a graceful restart for planned restarts. A planned restart is a failover initiated by the administrator (see "Enabling and Disabling NSF" on page 258).
 - Always—OSPFv3 will perform a graceful restart for all planned and unplanned warm restart events.
 - Disable—OSPFv3 will not perform graceful restarts.
- Restart Interval — The grace period during which a neighboring router will be in the helper state after receiving notice that the management unit is performing a graceful restart.
- Restart Status — Displays the restart status of OSPFv3 Helper feature. The possible values are:
 - Not Restarting
 - Planned Restart
 - Unplanned Restart
- Restart Age (secs) — Displays the amount of time since the last restart occurred.
- Restart Exit Reason — Displays how the master unit on the stack last started up. The possible values are:
 - Not Attempted—Graceful restart has not been attempted.
 - In Progress—Restart is in progress.
 - Completed—The previous graceful restart completed successfully.
 - Timed Out—The previous graceful restart timed out.
 - Topology Changed—The previous graceful restart terminated prematurely because of a topology change.

If you change the Support Mode, click **Submit** to save your change.

Click **Refresh** to redisplay the page with the latest values from the switch.

Enabling the NSF OSPFv3 Graceful Restart Using CLI Commands

For information about the CLI command that performs this function, see the following chapter in the *CLI Reference Guide*:

- OSPFv3 Commands

The following table summarizes the equivalent CLI commands for this feature.

Table 10-26. NSF OSPFv3 Graceful Restart Command

CLI Command	Description
nsf	Enables non-stop forwarding.
nsf helper	Enables helpful neighbor functionality for the OSPFv3 protocol.
nsf helper strict-lsa-checking	Requires that an OSPFv3 helpful neighbor exit helper mode whenever a topology change occurs.
show ipv6 ospf	Displays information relevant to the OSPFv3 router.
show ipv6 ospf neighbor	This command displays information about OSPFv3 neighbors.

IPv6 Routes

The **IPv6 Routes** menu page contains links to web pages that define and display IPv6 Routes parameters and data. To display this page, click **IPv6** → **IPv6 Routes** in the tree view. Following are the web pages accessible from this menu page:

- IPv6 Route Entry Configuration
- IPv6 Route Table
- IPv6 Route Preferences
- Configured IPv6 Routes

IPv6 Route Entry Configuration

Use the **IPv6 Route Entry Configuration** page to configure information for IPv6 routes.

To display the page, click **IPv6** → **IPv6 Routes** → **IPv6 Route Entry Configuration** in the tree view.

Figure 10-32. IPv6 Route Entry Configuration

The screenshot shows the Dell OpenManage Switch Administrator interface. The top navigation bar includes 'Support', 'Help', 'About', and 'Log Out'. The main header displays the Dell logo and 'PowerConnect 6224P'. The breadcrumb path is 'IPv6 > IPv6 Routes > IPv6 Route Entry Configuration'. The left sidebar shows a tree view with 'IPv6' expanded to 'Interface Configuration'. The main content area is titled 'IPv6 Route Entry Configuration' and contains a form with the following fields:

Route Type	Global
IPv6 Network Prefix	
IPv6 Network Prefix Length	
Interface	vlan111
Next Hop IPv6 Address	
Preference	1 (1 to 255)

Buttons for 'Print', 'Refresh', and 'Apply Changes' are visible.

The **IPv6 Route Entry Configuration** page contains the following fields:

- **IPv6 Network Prefix/PrefixLength** — Enter a valid IPv6 Network Address and Prefix.
- **Next Hop IPv6 Address** — Enter an IPv6 Next Hop Address. If the Next Hop IPv6 Address specified is a Link-local IPv6 Address, specify the Interface for the Link-local IPv6 Next Hop Address. Select Global or Link-local from the drop-down menu to apply to this address.
- **Preference** — Enter a Preference Value for the given route. Valid values are 1 to 255, with the default as 1.

Configuring IPv6 Route Entry

1. Open the **IPv6 Route Entry Configuration** page.

2. Modify the fields as needed.
3. Click **Apply Changes**.

The route entry is configured for IPv6, and the device is updated.

Configuring Route Entry the CLI Command

For information about the CLI commands that perform this function, see the following chapter in the *CLI Reference Guide*:

- IPv6 Routing Commands

The following table summarizes the equivalent CLI commands for this feature.

Table 10-27. IPv6 Route Commands

CLI Command	Description
ipv6 route	Configures an IPv6 static route

IPv6 Route Table

Use the **IPv6 Route Table** page to display all active IPv6 routes and their settings.

To display the page, click **IPv6** → **IPv6 Routes** → **IPv6 Route Table** in the tree view.

Figure 10-33. IPv6 Route Table

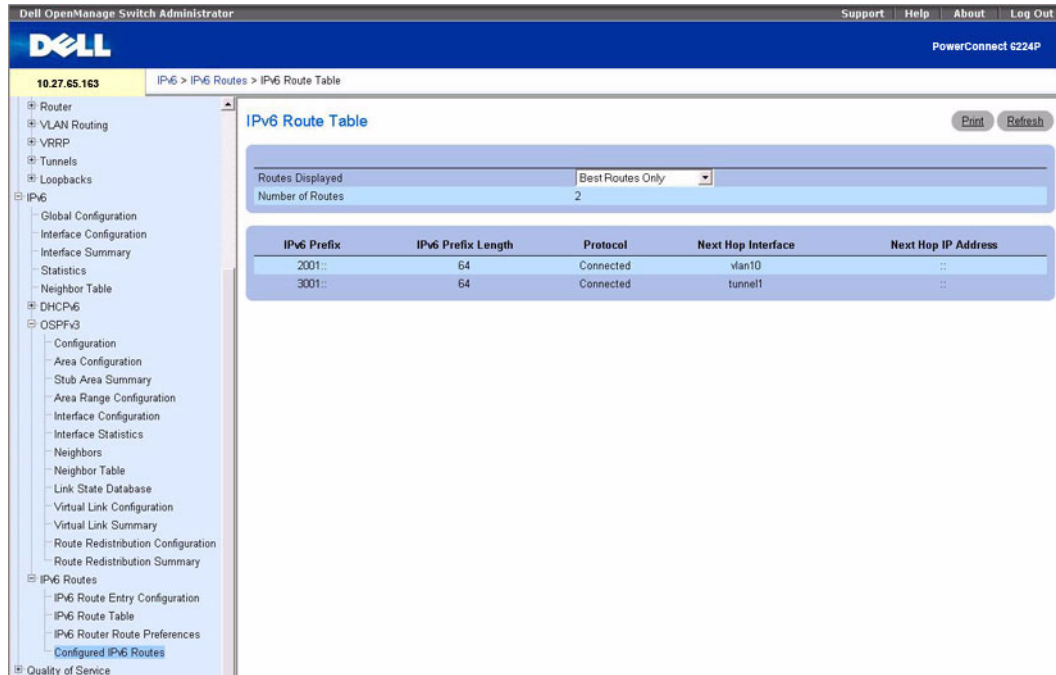

The IPv6 Route Table page displays the following fields:

- **Routes Displayed** — Select to view either the Configured Routes, Best Routes, or All Routes from the drop-down menu.
- **Number of Routes** — Displays the total number of active routes/best routes in the route table for the type of route selected.
- **IPv6 Prefix/Prefix Length** — Displays the Network Prefix and Prefix Length for the Active Route.
- **Protocol** — Displays the Type of Protocol for the Active Route.
- **Next Hop Interface** — Displays the Interface over which the Route is Active.
- **Next Hop IP Address** — Displays the Next Hop IPv6 Address for the Active Route.

Displaying the IPv6 Route Table

1. Open the IPv6 Route Table page.
2. Select the type of routes to display from the **Routes Displayed** field.
The selected routes display.

Displaying the IPv6 Route Table Using CLI Commands

For information about the CLI commands that perform this function, see the following chapter in the *CLI Reference Guide*:

- IPv6 Routing Commands

The following table summarizes the equivalent CLI commands for this feature.

Table 10-28. IPv6 Route Table Command

CLI Command	Description
show ipv6 route	Displays the IPv6 routing table.
show ipv6 route summary	Displays a summary of the routing table.

IPv6 Route Preferences

Use the **IPv6 Route Preferences** page to configure the default preference for each protocol. These values are arbitrary values in the range of 1 to 255 and are independent of route metrics. Most routing protocols use a route metric to determine the shortest path known to the protocol, independent of any other protocol. The best route to a destination is chosen by selecting the route with the lowest preference value. When there are multiple routes to a destination, the preference values are used to determine the preferred route. If there is still a tie, the route with the best route metric is chosen. To avoid problems with mismatched metrics you must configure different preference values for each of the protocols.

To display the page, click **IPv6** → **IPv6 Routes** → **IPv6 Route Preferences** in the tree view.

Figure 10-34. IPv6 Route Preferences

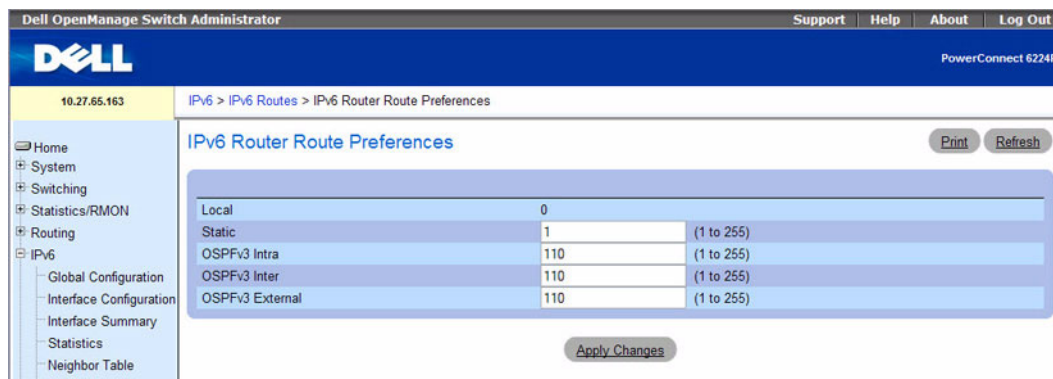

The **IPv6 Route Preferences** page contains the fields shown below. In each case, the lowest values indicate the highest preference.

- **Local** — This field displays the local route preference value.
- **Static** — The static route preference value in the router. The default value is 1. The range is 1 to 255.

- **OSPF Intra** — The OSPF intra route preference value in the router. The default value is 110.
- **OSPF Inter** — The OSPF inter route preference value in the router. The default value is 110.
- **OSPF External** — The OSPF External route preference value in the router (OSPF Type-1 and OSPF Type-2 routes). The default value is 110.

Configuring IPv6 Route Preferences

1. Open the **IPv6 Route Preferences** page.
2. Configure the default preference for each protocol.
3. Click **Apply Changes**.
Route preferences are configured for IPv6, and the device is updated.

Configuring IPv6 Route Preference Using CLI Commands

For information about the CLI commands that perform this function, see the following chapter in the *CLI Reference Guide*:

- IPv6Routing Commands

The following table summarizes the equivalent CLI commands for this feature.

Table 10-29. IPv6 Route Preference Command

CLI Command	Description
ipv6 route distance	Sets the default distance (preference) for static routes.
show ipv6 route preference	Shows the preference value associated with the type of route.

Configured IPv6 Routes

Use the **Configured IPv6 Routes** page to display selected IPv6 routes.

To display the page, click **IPv6** → **IPv6 Routes** → **Configured IPv6 Routes** in the tree view.

Figure 10-35. Configured IPv6 Routes

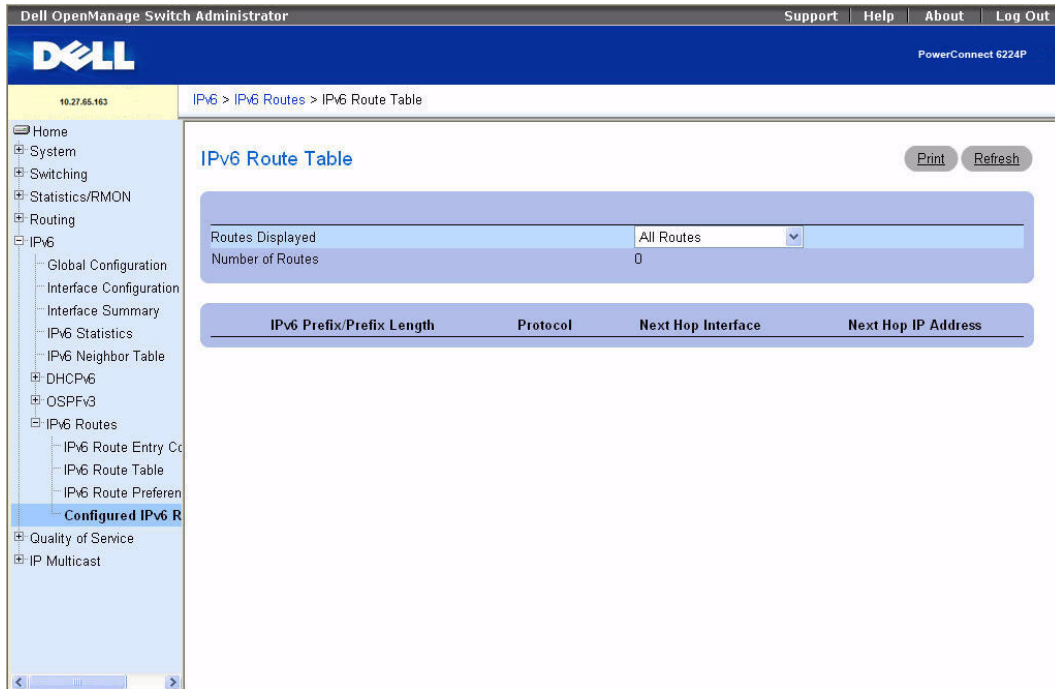

The **Configured IPv6 Routes** page contains the following fields:

- **Routes Displayed** — Select to view either the Configured Routes, Best Routes or All Routes.

When the Configured Routes option is selected, the following fields appear:

- **IPv6 Prefix/Prefix Length** — Displays the Network Prefix and Prefix Length for the Configured Route.
- **Next Hop IP** — Displays the Next Hop IPv6 Address for the Configured Route.
- **Next Hop Interface** — Displays the Next Hop Interface for the Configured Route.
- **Preference** — Displays the Route Preference of the Configured Route.
- **Delete** — Click this box and the Refresh button to delete the displayed route.

When the Best Routes or All Routes options are select, the following fields appear:

- **Number of Routes** — Displays the number of Best Routes or All Routes.
- **IPv6 Prefix/Prefix Length** — Displays the Network Prefix and Prefix Length for the Configured Route.
- **Protocol** — Displays the protocol in use for the Configured routes.
- **Next Hop Interface** — Displays the Next Hop Interface for the Configured Route.
- **Next Hop IP Address** — Displays the Next Hop IPv6 Address for the Configured Route.

Displaying IPv6 Routes

1. Open the **Configured IPv6 Routes** page.
2. Select the routes to view from the **Routes Displayed** drop-down menu.

The selected routes and their configurations display.

Displaying Configured IPv6 Routes Using CLI Commands

For information about the CLI commands that perform this function, see the following chapter in the *CLI Reference Guide*:

- IPv6 Routing Commands

The following table summarizes the equivalent CLI commands for this feature.

Table 10-30. IPv6 Configured Routers Commands

CLI Command	Description
show ipv6 route	Displays the IPv6 routing table.

Configuring Quality of Service

Overview

The **Quality of Service** menu page contains links to the following pages:

- Differentiated Services
- Class of Service
- Auto VoIP

In a typical switch, each physical port consists of one or more queues for transmitting packets on the attached network. Multiple queues per port are often provided to give preference to certain packets over others based on user-defined criteria. When a packet is queued for transmission in a port, the rate at which it is serviced depends on how the queue is configured and possibly the amount of traffic present in the other queues of the port. If a delay is necessary, packets get held in the queue until the scheduler authorizes the queue for transmission. As queues become full, packets have no place to be held for transmission and get dropped by the switch.

QoS is a means of providing consistent, predictable data delivery by distinguishing between packets that have strict timing requirements from those that are more tolerant of delay. Packets with strict timing requirements are given “special treatment” in a QoS capable network. With this in mind, all elements of the network must be QoS-capable. The presence of at least one node which is not QoS-capable creates a deficiency in the network path and the performance of the entire packet flow is compromised.

Differentiated Services

DiffServ Overview

The QoS feature contains Differentiated Services (DiffServ) support that allows traffic to be classified into streams and given certain QoS treatment in accordance with defined per-hop behaviors.

Standard IP-based networks are designed to provide “best effort” data delivery service. “Best effort” service implies that the network delivers the data in a timely fashion, although there is no guarantee that it will. During times of congestion, packets may be delayed, sent sporadically, or dropped. For typical Internet applications, such as e-mail and file transfer, a slight degradation in service is acceptable and in many cases unnoticeable. Conversely, any degradation of service has undesirable effects on applications with strict timing requirements, such as voice or multimedia.

Defining DiffServ

To use DiffServ for QoS, the web pages accessible from the **Differentiated Services** menu page must first be used to define the following categories and their criteria:

1. Class: create classes and define class criteria
2. Policy: create policies, associate classes with policies, and define policy statements
3. Service: add a policy to an inbound interface

Packets are classified and processed based on defined criteria. The classification criteria is defined by a class. The processing is defined by a policy's attributes. Policy attributes may be defined on a per-class instance basis, and it is these attributes that are applied when a match occurs. A policy can contain multiples classes. When the policy is active, the actions taken depend on which class matches the packet.

Packet processing begins by testing the class match criteria for a packet. A policy is applied to a packet when a class match within that policy is found.

The **Differentiated Services** menu page contains links to the various Diffserv configuration and display features.

To display the page, click **Quality of Service** → **Differentiated Services** in the tree view. The Differentiated Services menu page contains links to the following features:

- Diffserv Configuration
- Class Configuration
- Class Criteria
- Policy Configuration
- Policy Class Definition
- Service Configuration
- Service Detailed Statistics

Diffserv Configuration

Use the **Diffserv Configuration** page to display DiffServ General Status Group information, which includes the current administrative mode setting as well as the current and maximum number of rows in each of the main DiffServ private MIB tables.

To display the page, click **Quality of Service** → **Differentiated Services** → **Diffserv Configuration** in the tree view.

Figure 11-1. Diffserv Configuration

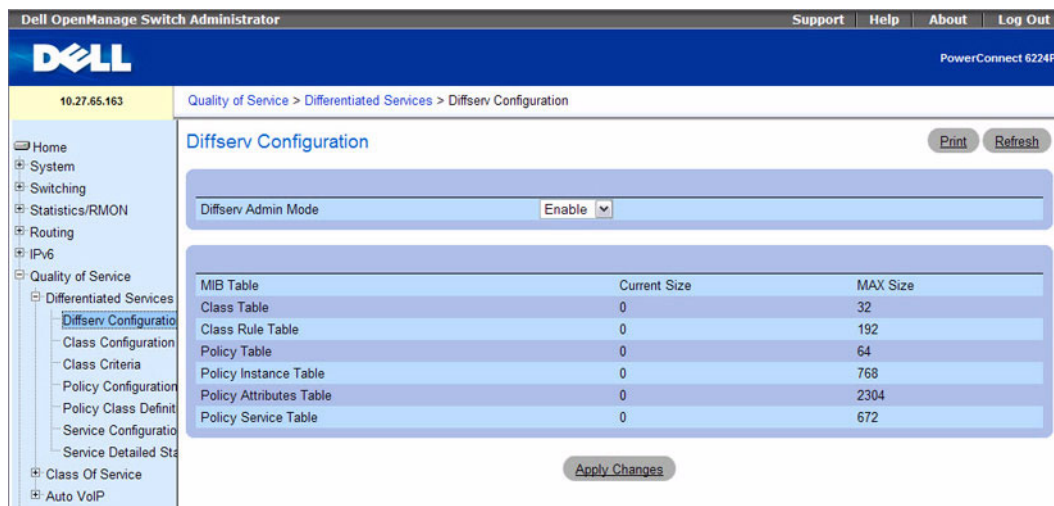

The **Diffserv Configuration** page contains the following fields:

Diffserv Admin Mode — Turns admin mode on and off. While disabled, the DiffServ configuration is retained and can be changed, but it is not active. While enabled, Differentiated Services are active.

MIB Table

- **Class Table** — Displays the current and maximum number of rows of the class table.
- **Class Rule Table** — Displays the current and maximum number of rows of the class rule table.
- **Policy Table** — Displays the current and maximum number of rows of the policy table.
- **Policy Instance Table** — Displays the current and maximum number of rows of the policy instance table.
- **Policy Attributes Table** — Displays the current and maximum number of rows of the policy attributes table.
- **Service Table** — Displays the current and maximum number of rows of the service table.

Changing Diffserv Admin Mode

1. Open the **Diffserv Configuration** page.
2. Turn **Diffserv Admin Mode** on or off by selecting **Enable** or **Disable** from the drop-down menu.
3. Click **Apply Changes**.

The Diffserv Admin Mode is changed, and the device is updated.

Displaying MIB Tables Using CLI Commands

For information about the CLI commands that perform this function, see the following chapter in the *CLI Reference Guide*:

- [QoS Commands](#)

The following table summarizes the equivalent CLI commands for this feature.

Table 11-1. DiffServ Configuration Commands

CLI Command	Description
diffserv	Sets the DiffServ operational mode to active.
show diffserv	Displays the DiffServ General Status information.

Class Configuration

Use the **Diffserv Class Configuration** page to add a new Diffserv class name, or to rename or delete an existing class.

To display the page, click **Quality of Service** → **Differentiated Services** → **Class Configuration** in the tree view.

Figure 11-2. Diffserv Class Configuration

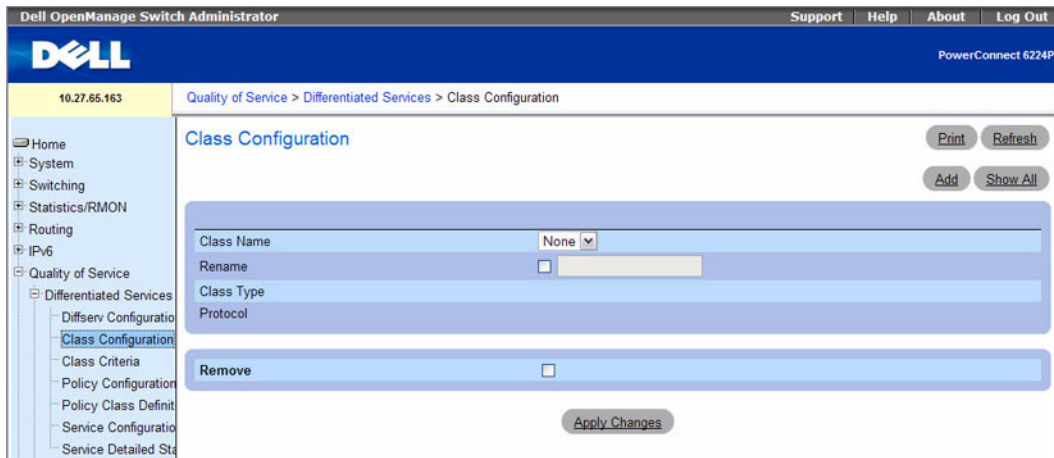

The Diffserv Class Configuration page contains the following fields:

- **Class Name** — Selects a class name to rename or delete. Click **Add** to set up a new class name.
- **Rename** — Renames the class displayed when the box is checked and a new name is entered.
- **Class Type** — Lists the class types. Currently the hardware supports only the **Class Type** value **All**.
 - **All** — All the various match criteria defined for the class should be satisfied for a packet match. **All** signifies the logical **AND** of all the match criteria.
- **Protocol** — Indicates how to interpret Layer 3. This field displays the types of packets supported by DiffServ. The Layer 3 Protocol option is available only when you select Class Type. Options are:
 - **IPv4** — A class where the match criteria is based on fields in an IPv4 packet.
 - **IPv6** — A class where the match criteria is based on fields in an IPv6 packet.

The protocol is chosen on the **Add DiffServ Class** page. See "Adding a DiffServ Class" on page 685.

- **Remove** — Deletes the displayed class name when checked and **Apply Changes** is clicked.

Adding a DiffServ Class

1. Open the **Diffserv Class Configuration** page.
2. Click **Add**.

The **Add DiffServ Class** page displays

Figure 11-3. Add DiffServ Class

The screenshot shows a web interface for adding a DiffServ class. The title is "Add Class". There are two buttons at the top right: "Print" and "Refresh". The main form area is light blue and contains three rows of input fields. The first row is "Class Name" with a text input field and a note "(1 to 31 alphanumeric characters)". The second row is "Class Type" with a dropdown menu currently showing "All". The third row is "Protocol" with a dropdown menu currently showing "IPv4". Below the form are two buttons: "Apply Changes" and "Back".

Enter a name for the class and select the protocol to use for class match criteria.

3. Click Apply Changes.

The new class is added and the device is updated.

Adding a Class Configuration Using CLI Commands

For information about the CLI commands that perform this function, see the following chapter in the *CLI Reference Guide*:

- QoS Commands

The following table summarizes the equivalent CLI commands for this feature.

Table 11-2. Class Configuration Commands

CLI Command	Description
class-map	Defines a new DiffServ class of type <i>match-all</i> , <i>match-any</i> , or <i>match-access-group</i> . For now, only <i>match-all</i> is available in the CLI.
class-map rename	Changes the name of a DiffServ class.

Class Criteria

Use the **Diffserv Class Criteria** page to define the criteria to associate with a DiffServ class. As packets are received, these DiffServ classes are used to prioritize packets.

To display the page, click **Quality of Service** → **Differentiated Services** → **Class Criteria** in the tree view.

Figure 11-4. Diffserv Class Criteria IPv4



The Diffserv Class Criteria page contains the following fields:

- **Class Name** — Selects the class name for which you are specifying criteria.
- **Class Type** — Displays the class type. The only configurable class type supported is All.

Match Attributes (IPv4)

Use the following fields to match IPv4 packets to a class. Click the check box for each field to be used as a criterion for a class, and enter data in the related field. You can have multiple match criteria in a class. The logic is a Boolean “logical-and” for this criteria.

- **Source IP Address** — Requires a packet’s source port IP address to match the address listed here.
- **Subnet Mask** — The subnet mask of the source IP address. This field is required when **Source IP Address** is checked.
- **Destination IP Address** — Requires a packet’s destination port IP address to match the address listed here.

- **Subnet Mask** — The subnet mask of the destination IP address. This field is required when **Destination IP Address** is checked.
- **Source L4 Port**— Requires a packet’s TCP/UDP source port to match the port listed here. Select one of the following options:
 - **Select From List** — Click to select from a list of well known source ports to which packets are matched.
 - **Match to Port** — Click to add a user-defined Port ID to which packets are matched. Range is 0-65535.
- **Destination L4 Port** — Requires a packet’s TCP/UDP destination port to match the port listed here. Select one of the following:
 - **Select From List** — Select from a list of well known destination ports to which packets are matched.
 - **Match to Port** — Click to add a user-defined Port ID to which packets are matched. Range is 0-65535.
- **Protocol** — Requires a packet’s protocol to match the protocol listed here. Select one of the following:
 - **Select from List** — Select from the drop-down list of protocols.
 - **Match to Protocol ID** — Enter a protocol ID to which packets are matched. Range is 0-255.
- **EtherType** — Requires a frames’ Ethertype to match the Ethertype listed here. Select one of the following:
 - **Select from List** — Select from the drop-down list of EtherTypes.
 - **Match to Value** — Enter an Ethertype ID to which packets are matched. Range is 0600-FFFF.
- **Class of Service** — Requires a packet’s Class of Service (CoS) for incoming packets to match the CoS entered here. Range is 0-7.
- **Source MAC Address** — Requires a packet’s Source MAC Address for incoming packets to match the address entered here.
- **Source MAC Mask** — Specifies the Source MAC address wildcard mask. Wild card masks determine which bits are used and which bits are ignored. A wild card mask of 00.00.00.00.00.00 indicates that no bit is important. A wildcard of FF:FF:FF:FF:FF:FF indicates that all bits are important. This field is required when **Source MAC Address** is checked.
- **Destination MAC Address** — Requires a packet’s Destination MAC Address for incoming packets to match the address entered here.
- **Destination MAC Mask** — Specifies the Destination MAC address wildcard mask. Wild card masks determine which bits are used and which bits are ignored. A wild card mask of 00.00.00.00.00.00 indicates that no bit is important. A wildcard of FF:FF:FF:FF:FF:FF indicates that all bits are important. This field is required when **Destination MAC Address** is checked.
- **VLAN ID** — Requires a packet’s VLAN ID for incoming packets to match the VLAN ID entered here. Range is 0-4095.

- **Reference Class** — Selects a class to start referencing for criteria. Select the **Add Diffserv Class** check box, then select a previously configured Diffserv class from the related drop-down menu.

Figure 11-5. Diffserv Class Criteria IPv6

The screenshot shows the Dell OpenManage Switch Administrator interface. The top navigation bar includes 'Support', 'Help', 'About', and 'Log Out'. The breadcrumb trail is 'Quality of Service > Differentiated Services > Class Criteria'. The left sidebar shows a tree view with 'Quality of Service' expanded to 'Differentiated Services' > 'Class Criteria'. The main content area is titled 'Class Criteria' and contains the following sections:

- Class Criteria:** Class Name: Class2, Class Type: All.
- Match Attributes:**
 - Source IPv6 Prefix: [text field]
 - Source IPv6 Prefix Length: [text field]
 - Destination IPv6 Prefix: [text field]
 - Destination IPv6 Prefix Length: [text field]
 - Source L4 Port: Select From List [dropdown]
 - Match to Port: [text field] (0 - 65535)
 - Destination L4 Port: Select From List [dropdown]
 - Match to Port: [text field] (0 - 65535)
 - Protocol: Select From List [dropdown]
 - Match to Protocol ID: [text field] (0 - 255)
 - IPv6 Flow Label: [text field] (0 - 1048575)
 - Reference Class: Add Diffserv Class [dropdown]
- Service Type:** IP DSCP: Select From List [dropdown] Match to Value [text field] (0 - 63)
- Match Every:**

An 'Apply Changes' button is located at the bottom of the form.

Match Attributes (IPv6)

Use the following fields to match IPv6 packets to a class. For other fields not listed here, see the description in "Match Attributes (IPv4)" on page 687. Click the check box for each field to be used as a criterion for a class, and enter data in the related field. You can have multiple match criteria in a class. The logic is a Boolean "logical-and" for this criteria.

- **Source IPv6 Prefix** — Requires a packet's source port IPv6 address to match the address listed here. Enter the address in the format: `aaaa:aaaa:aaaa:aaaa`.
- **Source IPv6 Prefix Length** — Prefix Length can be entered in the range of 0-128.
- **Destination IPv6 Prefix** — Requires a packet's destination port IPv6 address to match the address listed here. Enter the address in the format: `aaaa:aaaa:aaaa:aaaa`.
- **Destination IPv6 Prefix Length** — Prefix Length can be entered in the range of 0 to 128.
- **IPv6 Flow Label** — Flow label is a 20-bit number that is unique to an IPv6 packet, used by end stations to signify quality-of-service handling in routers. The flow label of the incoming packet must match this value. Range is 0-1048575.

Service Type Criteria

Click to select one of the following three Match fields to use in matching packets to class criteria:

- **IP DSCP** — Matches the packet's DSCP to the class criteria's when selected. Either select the DSCP type from the drop-down menu or enter a DSCP value to match. Valid range is 0-63.
- **Match Every** — Requires a packet to match every criterion when **Match Every** is checked.

Configuring Class Criteria with CLI Commands

For information about the CLI commands that perform this function, see the following chapter in the *CLI Reference Guide*:

- QoS Commands

The following table summarizes the equivalent CLI commands for this feature.

Table 11-3. Class Configuration Commands

CLI Command	Description
class	Creates an instance of a class definition within the specified policy for the purpose of defining treatment of the traffic class through subsequent policy attribute statements.

Policy Configuration

Use the **Diffserv Policy Configuration** page to associate a collection of classes with one or more policy statements.

To display the page, click **Quality of Service** → **Differentiated Services** → **Policy Configuration** in the tree view.

Figure 11-6. Diffserv Policy Configuration

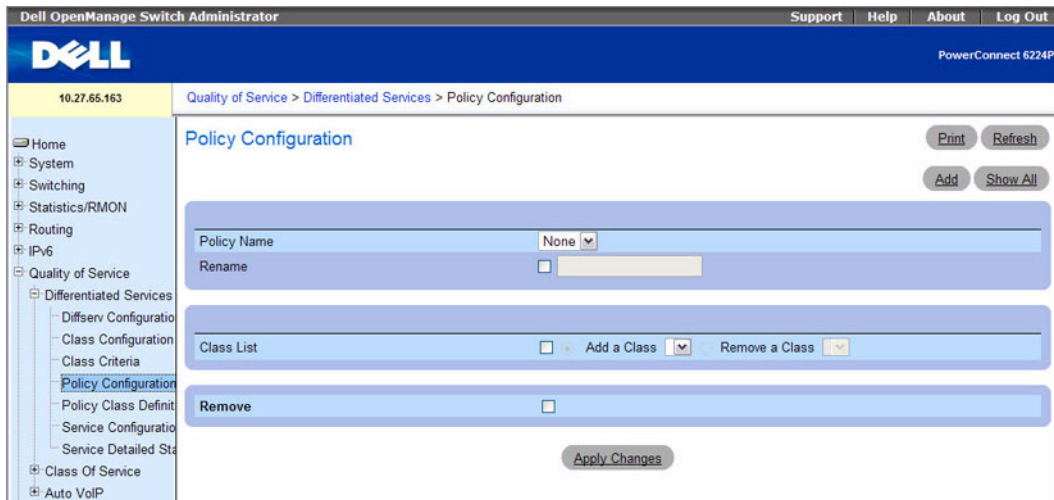

The Diffserv Policy Configuration page contains the following fields:

- **Policy Name** — Selects the policy name to be associated with the class(es).
- **Rename Policy** — Renames a policy when box is checked, a new name is entered, and **Apply Changes** is clicked.
- **Class List** — Configures class association for the policy.
 - **Add a Class** — Associates the class selected in the drop-down menu to a policy.
 - **Remove a Class** — Removes the selected class from the policy.
- **Remove** — Deletes the selected policy name from the device.

Associating a Class to a Policy or Removing the Association

1. Open the Diffserv Policy Configuration page.
2. Select the **Policy Name** to associate with the class.
3. In **Class List** field, select the check box, then click the **Add a Class** or **Remove a Class** radio button and select the class from the related drop down menu

Use **Add a Class** to associate a class with this policy. Use **Remove a Class** to remove the class from this policy.

4. Select the class to be affected from the relevant drop-down menu.
5. Click **Apply Changes**.

The modified policy is saved, and the device is updated.

Renaming a Policy

1. Open the **Diffserv Policy Configuration** page.
2. Select the **Policy Name** to be renamed.
3. Rename policy by checking **Rename Policy** and entering the new name in the adjacent field.

The modified policy name is saved, and the device is updated.

Adding a New Policy Name

1. Open the **Diffserv Policy Configuration** page.
2. Click **Add**.

The **Add Diffserv Policy** page displays.

Figure 11-7. Add Diffserv Policy

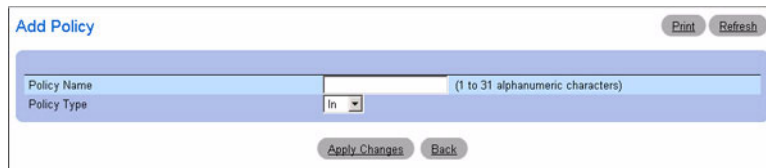

3. Enter the new **Policy Name**.
4. Click **Apply Changes**.

The new policy is saved, and the device is updated.

Displaying the Policy Summary

1. Open the **Policy Configuration** page.
2. Click **Show All**.

The **Diffserv Policy Summary** page displays all policy names, their policy types, and their member classes.

Figure 11-8. Diffserv Policy Summary

	Policy Name	Member Classes
1	Policy1	Class1
2	Policy2	

Removing a Policy Configuration

1. Open the **Diffserv Policy Configuration** page.
2. Select the policy name to be deleted from the **Policy Name** drop-down menu.
3. Check the **Remove** check box.
4. Click **Apply Changes**.

The associated policy configuration is removed, and the device is updated.

Defining Policy Configurations Using CLI Commands

For information about the CLI commands that perform this function, see the following chapter in the *CLI Reference Guide*:

- QoS Commands

The following table summarizes the equivalent CLI commands for this feature.

Table 11-4. Policy Configuration Commands

CLI Command	Description
policy-map	Establishes a new DiffServ policy
show policy-map	Displays all configuration information for the specified policy.
show policy-map interface	Displays policy-oriented statistics information for the specified interface and direction

Policy Class Definition

Use the **Diffserv Policy Class Definition** page to associate a class to a policy, and to define attributes for that policy-class instance.

To display the page, click **Quality of Service** → **Differentiated Services** → **Policy Class Definition** in the tree view.

Figure 11-9. Diffserv Policy Class Definition

The screenshot shows the Dell OpenManage Switch Administrator interface. The top navigation bar includes 'Support', 'Help', 'About', and 'Log Out'. The breadcrumb trail is 'Quality of Service > Differentiated Services > Policy Class Definition'. The left navigation tree is expanded to 'Quality of Service > Differentiated Services > Policy Class Definition'. The main content area is titled 'Policy Class Definition' and contains the following fields:

- Policy Name:** A text input field with a dropdown menu set to 'None'.
- Member Classes:** A dropdown menu.
- Drop Packets:** A checkbox.
- Assign Queue:** A dropdown menu set to '(0 - 6)'.
- Traffic Conditioning:** A checkbox and a dropdown menu set to 'Configured: None'.
- Redirect Interface:** A checkbox and a dropdown menu set to 'Unit 1 Port g1 LAG ch1'.
- Flow Based Mirroring:** A checkbox and a dropdown menu set to 'Unit 1 Port g1 LAG ch1'.

Buttons for 'Print', 'Refresh', 'Show All', and 'Apply Changes' are also visible.

The **Diffserv Policy Class Definition** page contains the following fields:

- **Policy Name** — Selects the policy to associate with a member class from a drop-down menu.
- **Member Classes** — Selects the member class to associate with this policy name from a drop-down menu.
- **Drop Packets** — Select this field to drop packets for this policy-class.
- **Assign Queue** — Assigns the packets of this policy-class to a queue. The valid range is 0–6.
- **Traffic Conditioning** — Assigns a type of traffic conditioning when checked and a condition is selected from the drop-down menu. This field affects how traffic that matches this policy-class is treated. Choose from **None**, **Marking**, and **Policing**. When **Marking** or **Policing** is selected, the screen changes to display related fields.
 - **None:** Specifies no traffic conditioning occurs during packet processing. This is the default.
 - **Marking:** Allows you to mark one of the following fields in the packet: IP DSCP, IP Precedence, or Class of Service. For information on the fields that display when **Marking** is selected, see "Packet Marking Traffic Condition."

- **Policing:** Allows you to configure how policing is performed, as well as configure what happens to packets that are considered conforming and non-conforming. For more information on the fields that display when **Policing** is selected, see "Policing Traffic Condition."
- **Redirect Interface** — Displays whether Redirect Interface applies to this policy-class, and specifies the interface or LAG used.
- **Flow Based Mirroring** — Displays whether Flow Based Mirroring applies to this policy-class, and specifies the interface or LAG used.

Defining a Policy-Class Instance

1. Open the **Diffserv Policy Class Definition** page.
2. Select a policy and member class to associate.
3. Specify attributes to apply to this policy-class instance using the remaining fields on the page.
4. Click **Apply Changes**.

The policy-class is defined, and the device is updated.

Packet Marking Traffic Condition

When **Marking** is chosen as the **Traffic Condition**, the following Packet Marking page displays.

Figure 11-10. Policy Class Definition - Packet Marking

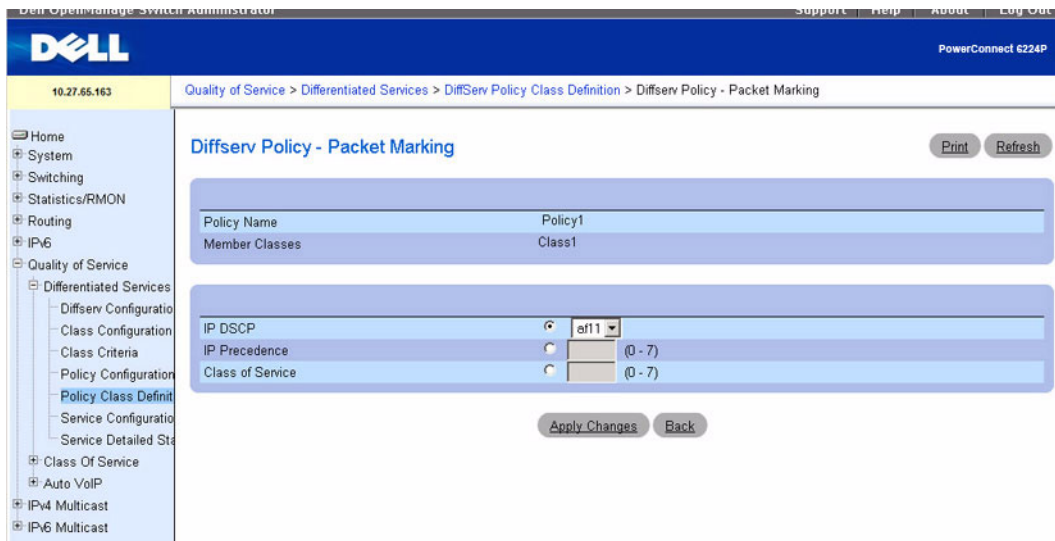

The **Diffserv Policy - Packet Marking** page contains the following fields:

- **Policy Name**— Displays the policy associated with a member class.
- **Member Classes** — Displays the member class associated with this policy name.

You have the option of marking one of the following fields in the packet:

- **IP DSCP** — Selects the IP DSCP to mark. Select from the drop down menu or enter directly in the User Value field.
- **IP Precedence** — Selects the specified IP Precedence queue number to mark.
- **Class of Service** — Selects the specified Class of Service queue number to mark.

Configuring Packet Marking for a Policy Class Instance

1. Select **Marking** from the **Traffic Conditioning** drop-down menu on the **Diffserv Policy Class Definition** page.

The **Packet Marking** page displays.

2. Select **IP DSCP**, **IP Precedence**, or **Class of Service** to mark for this policy-class.
3. Select or enter a value for this field.
4. Click **Apply Changes**.
The policy-class is defined, and the device is updated.

Policing Traffic Condition

When **Policing** is chosen as the **Traffic Condition**, the following **Diffserv Policy - Policing** page displays.

Figure 11-11. Policy Class Definition - Policing

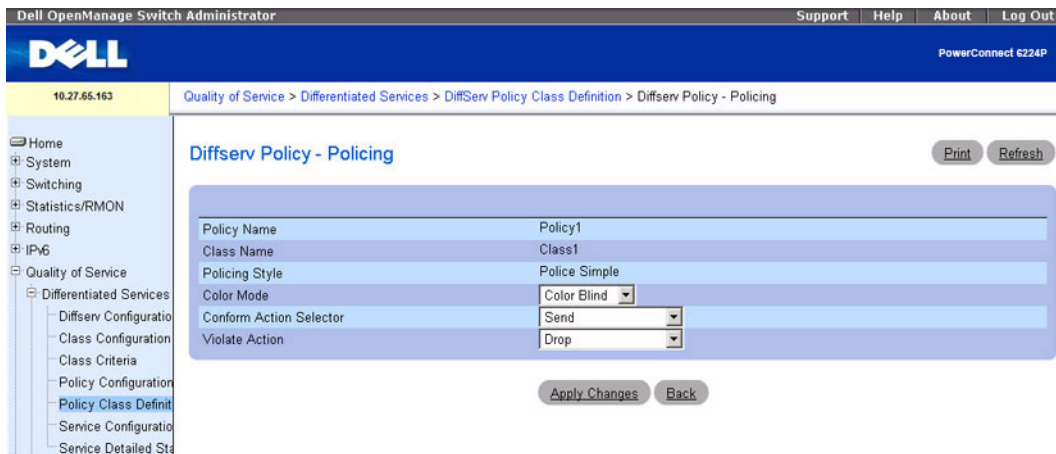

The **Diffserv Policy - Policing** page contains the following fields:

- **Policy Name** — Displays the policy for which policing is being configured.
- **Class Name** — Displays the member class associated with this policy name.
- **Policing Style** — Displays the style of policing being used.

- **Color Mode** — Selects the type of color policing used. Choose Color Blind or Color Aware from the drop-down menu.
- **Conform Action Selector** — Selects what happens to packets that are considered conforming (below the police rate). Options are Send, Drop, Mark CoS, Mark IP DSCP, Mark IP Precedence.
- **Violate Action** — Selects what happens to packets that are considered non-conforming (above the police rate). Options are Send, Drop, Mark CoS, Mark IP DSCP, Mark IP Precedence.

Configuring Policing for a Policy-Class Instance

1. Select **Policing** from the **Traffic Conditioning** drop-down menu on the **Diffserv Policy Class Definition** page.

The **Diffserv Policy - Policing** page displays.

2. Check to select one or more policing criteria to use for this policy-class.
3. Select or enter a value for each field selected.
4. Click **Apply Changes**.

The following **Policy Rate Configuration** page displays.

Figure 11-12. Policy Rate Configuration

Diffserv Policy - Policing		Print	Refresh
Policy Name	East		
Class Name	test		
Color Mode	Color Blind		
Committed Rate (Kbps)	<input type="text"/>	(1 to 4294967295) Kbps	
Committed Burst Size (KB)	<input type="text"/>	(1 to 128) KBytes	
Conform Action	Send		
Violate Action	Drop		

5. Enter the desired criteria values for Committed Rate and/or Committed Burst Size.
6. Click **Apply Changes**.
Policing is configured for the specified policy-class instance, and the device is updated.

Defining Policy Classes Using CLI Commands

For information about the CLI commands that perform this function, see the following chapter in the *CLI Reference Guide*:

- [QoS Commands](#)

The following table summarizes the equivalent CLI commands for this feature.

Table 11-5. Policy Class Configuration Commands

CLI Command	Description
assign-queue	Modifies the queue ID to which the associated traffic stream is assigned.
conform-color	Specifies for each outcome, the only possible actions are drop, set-cos-transmit, set-sec-cos-transmit, setdscp-transmit, set-prec-transmit, or transmit
drop	Use the drop policy-class-map configuration command to specify that all packets for the associated traffic stream are to be dropped at ingress.
mark cos	Marks all packets for the associated traffic stream with the specified class of service value in the priority field of the 802.1p header.
mark ip-dscp	Marks all packets for the associated traffic stream with the specified IP DSCP value.
mark ip-precedence	Marks all packets for the associated traffic stream with the specified IP precedence value.
match class-map	Adds add to the specified class definition the set of match conditions defined for another class.
match cos	Adds to the specified class definition a match condition for the Class of Service value.
match destination-address mac	Adds to the specified class definition a match condition based on the destination MAC address of a packet.
match dstip	Adds to the specified class definition a match condition based on the destination IP address of a packet.
match dstip6	adds to the specified class definition a match condition based on the destination IPv6 address of a packet.
match dstl4port	Adds to the specified class definition a match condition based on the destination layer 4 port of a packet using a single keyword, or a numeric notation.
match ethertype	Adds to the specified class definition a match condition based on the value of the ethertype.
match ip6flowlbl	Adds to the specified class definition a match condition based on the IPv6 flow label of a packet.
match ip dscp	Adds to the specified class definition a match condition based on the value of the IP DiffServ Code Point (DSCP) field in a packet.
match ip precedence	Adds to the specified class definition a match condition based on the value of the IP.
match ip tos	Adds to the specified class definition a match condition based on the value of the IP TOS field in a packet.

Table 11-5. Policy Class Configuration Commands (continued)

CLI Command	Description
match protocol	Adds to the specified class definition a match condition based on the value of the IP Protocol field in a packet using a single keyword notation or a numeric value notation.
match source-address mac	Adds to the specified class definition a match condition based on the source MAC address of the packet.
match srcip	Adds to the specified class definition a match condition based on the source IP address of a packet.
match srcip6	Adds to the specified class definition a match condition based on the source IPv6 address of a packet.
match srcl4port	Adds to the specified class definition a match condition based on the source layer 4 port of a packet using a single keyword, a numeric notation, or a numeric range notation.
match vlan	Adds to the specified class definition a match condition based on the value of the layer 2 VLAN Identifier field.
mirror	Mirrors all the data that matches the class defined to the destination port specified
police-simple	Establishes the traffic policing style for the specified class.
redirect	Specifies that all incoming packets for the associated traffic stream are redirected to a specific egress interface (physical port or port-channel).
show class-map	Displays all configuration information for the specified class.

Service Configuration

Use the Diffserv Service Configuration page to activate a policy on a port.

To display the page, click **Quality of Service** → **Differentiated Services** → **Service Configuration** in the tree view.

Figure 11-13. Diffserv Service Configuration

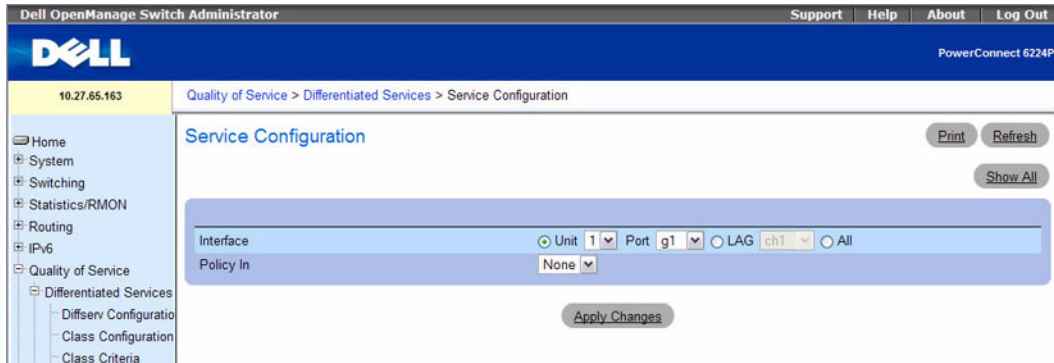

The Diffserv Service Configuration page contains the following fields:

- **Interface** — Selects the interface (Unit/Port, LAG, or All) to be affected from drop-down menus.
- **Policy In** — Selects the policy to be associated with the port from a drop-down menu.

Activating a Policy on a Port

1. Open the Diffserv Service Configuration page.
2. Select the interface from the drop-down menus.
3. Select the policy from the drop-down menu.
4. Click **Apply Changes**.
The policy is activated on the interface, and the device is updated.

Displaying Diffserv Service Summary

1. Open the Diffserv Service Configuration page.
2. Click **Show All**.
The Diffserv Service Summary page displays.

Figure 11-14. Diffserv Service Summary

	Interface	Direction	Operation Status	Policy Name
1	1/xg1	In	Down	East

Assigning a Policy to a Port Using CLI Commands

For information about the CLI commands that perform this function, see the following chapter in the *CLI Reference Guide*:

- QoS Commands

The following table summarizes the equivalent CLI commands for this feature.

Table 11-6. Service Configuration Command

CLI Command	Description
service-policy	Attaches a policy to an interface in a particular direction.
show diffserv service interface ethernet in	Displays policy service information for the specified interface and direction.
show diffserv service interface port-channel in	Displays policy service information for the specified interface and direction.
show service-policy	Displays a summary of policy-oriented statistics information for all interfaces in the specified direction.

Service Detailed Statistics

Use the **Diffserv Service Detailed Statistics** page to display packet details for a particular port and class. To display the page, click **Quality of Service** → **Differentiated Services** → **Service Detailed Statistics** in the tree view.

Figure 11-15. Diffserv Service Detailed Statistics

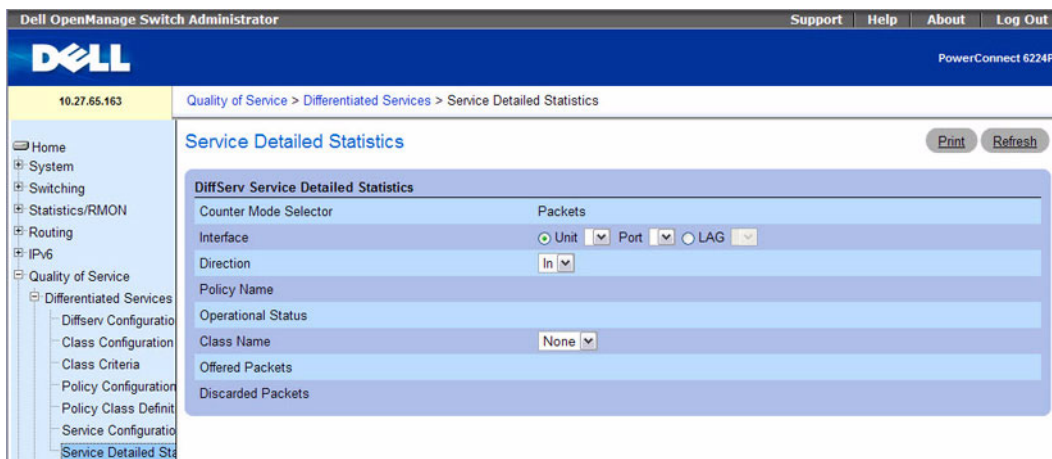

The Diffserv Service Detailed Statistics page contains the following fields:

- **Counter Mode Selector** — Type of statistics to display. Packets is the only available type.
- **Interface** — Selects the Unit and Port or LAG for which service statistics are to display.
- **Direction** — Selects the direction of packets for which service statistics are to display.
- **Policy Name** — Displays the policy associated with the selected interface.
- **Operational Status** — Displays whether the policy is active or not on this interface.
- **Member Classes** — Selects the member class for which octet statistics are to display.
- **Offered Packets** — Displays how many packets match the policy.
- **Discarded Packets** — Displays how many packets are dropped by the policy.

Displaying Service Statistics

1. Open the **Diffserv Service Detailed Statistics** page.
2. Complete the fields as needed.
Packet statistics display for the specified interface, direction, and class.

Configuring Service Statistics Using CLI Commands

For information about the CLI command that performs this function, see the following chapter in the *CLI Reference Guide*:

- **QoS Commands**

The following table summarizes the equivalent CLI commands for this feature.

Table 11-7. DiffServ Statistics Commands

CLI Command	Description
show diffserv service brief	Displays all interfaces in the system to which a DiffServ policy has been attached.

Class of Service

The Class of Service (CoS) queueing feature lets you directly configure certain aspects of switch queueing. This provides the desired QoS behavior for different types of network traffic when the complexities of DiffServ are not required. The priority of a packet arriving at an interface can be used to steer the packet to the appropriate outbound CoS queue through a mapping table. CoS queue characteristics that affect queue mapping, such as minimum guaranteed bandwidth, transmission rate shaping, etc., are user-configurable at the queue (or port) level.

Seven queues per port are supported. Although the hardware supports eight queues, one queue is always reserved for internal use by the stacking subsystem.

To display the page, click **Quality of Service** → **Class of Service** in the tree view. The **Class of Service** menu page contains links to the following features:

- Mapping Table Configuration
- Interface Configuration
- Interface Queue Configuration

Mapping Table Configuration

Each port in the switch can be configured to trust one of the packet fields (802.1p, IP Precedence, or IP DSCP), or to not trust any packet's priority designation (untrusted mode). If the port is set to a trusted mode, it uses a mapping table appropriate for the trusted field being used. This mapping table indicates the CoS queue to which the packet should be forwarded on the appropriate egress port(s). Of course, the trusted field must exist in the packet for the mapping table to be of any use, so there are default actions performed when this is not the case. These actions involve directing the packet to a specific CoS level configured for the ingress port as a whole, based on the existing port default priority as mapped to a traffic class by the current 802.1p mapping table.

Alternatively, when a port is configured as untrusted, it does not trust any incoming packet priority designation and uses the port default priority value instead. All packets arriving at the ingress of an untrusted port are directed to a specific CoS queue on the appropriate egress port(s), in accordance with the configured default priority of the ingress port. This process is also used for cases where a trusted port mapping is unable to be honored, such as when a non-IP packet arrives at a port configured to trust the IP DSCP value.

Use the **Mapping Table Configuration** page to define how class of service is assigned to a packet.

To display the page, click **Quality of Service** → **Class of Service** → **Mapping Table Configuration** in the tree view.

The Trust Mode selected on the **Mapping Table Configuration** page affects how the page displays and the fields accessible from the page. There are three trust modes available from here:

- Untrusted (None)
- CoS(802.1P)
- IP DSCP

CoS(802.1P) is the default mode, so this is the page that displays when **Mapping Table Configuration** is selected from the **Class of Service** menu page.

Figure 11-16. Mapping Table Configuration — CoS (802.1P)

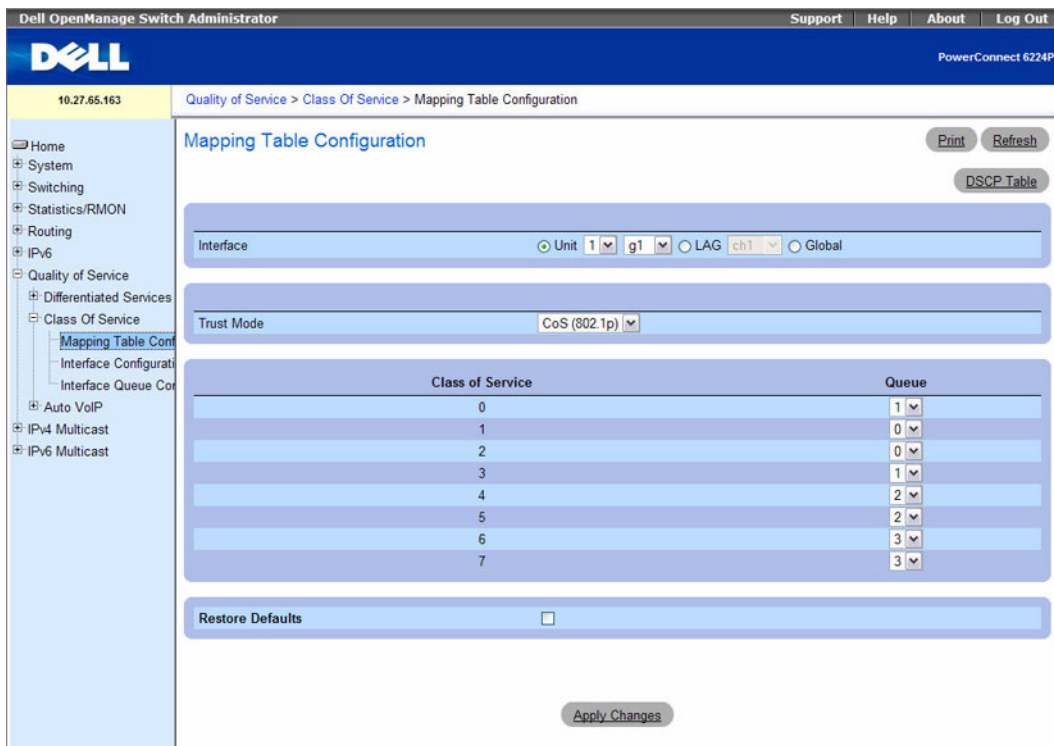

CoS (802.1P) Trust Mode

The CoS (802.1P) Mapping Table Configuration page contains the following fields:

- **Interface** — Selects the interface to which the class of service configuration is applied. Select a unit and port or LAG, or select Global to apply the class of configuration to all the interfaces.
- **Trust Mode** — Selects the trust mode to apply. CoS (802.1P) is the default.

- **Class of Service** — Lists each class of service on a separate line, so a separate queue can be assigned to each class of service.
- **Queue** — Selects a queue for each **Class of Service** from the drop-down menu. Default queues are displayed initially.
- **Restore Defaults** — Restores default queue values when checked and **Apply Changes** is clicked.

Configuring CoS (802.1P) Trust Mode

1. Open the **Mapping Table Configuration** page.
2. Select the unit and port or LAG to be affected, or select **Global** to apply the settings to all interfaces.
3. Select a **Trust Mode**.
4. Select a **Queue** to associate with each **Class of Service**.
5. Click **Apply Changes**.

Changes made are applied to the selected interfaces, and the device is updated.

Restoring Queue Defaults

1. Open the **Mapping Table Configuration** page.
2. Click the **Restore Defaults** check box.
3. Click **Apply Changes**.

Queues are returned to their defaults for each **Class of Service**, and the device is updated.

Configuring the IP DSCP Table

To access the **DSCP Queue Mapping Table**, click **Quality of Service** → **Class of Service** → **Mapping Table Configuration** in the tree view, and then click the **DSCP Table** link.

Figure 11-17. DSCP Queue Mapping Table

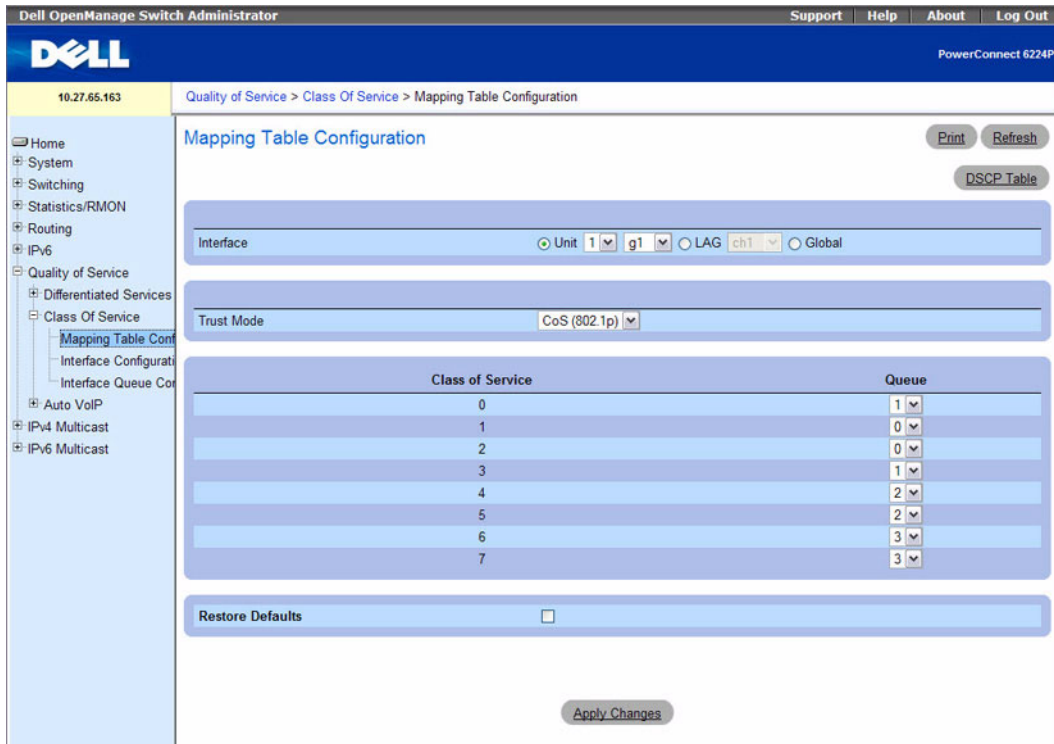

The DSCP Queue Mapping Table page contains the following fields:

- **DSCP In** — Check to select as a criterion, and enter which DiffServ Code Point in the packet to use. This field determines to which queue the packet is sent.
- **Queue ID** — Selects the queue to which the packet is sent.

Restoring Queue Defaults

1. Open the DSCP Queue Mapping Table page.
2. Click the Restore Defaults check box.
3. Click Apply Changes.
Queue values are returned to their defaults, and the device is updated.

Mapping Table Configuration Using CLI Commands

For information about the CLI commands that perform this function, see the following chapter in the *CLI Reference Guide*:

- QoS Commands

The following table summarizes the equivalent CLI commands for this feature.

Table 11-8. Mapping Table Configuration Commands

CLI Command	Description
classofservice dot1p-mapping	Maps an 802.1p priority to an internal traffic class for a switch.
classofservice ip-dscp-mapping	Maps an IP DSCP value to an internal traffic class.
classofservice trust	Sets the class of service trust mode of an interface.
show classofservice dot1p-mapping	Displays the current Dot1p (802.1p) priority mapping to internal traffic classes for a specific interface.
show classofservice ip-dscp-mapping	Displays the current IP DSCP mapping to internal traffic classes for a specific interface.
show classofservice trust	Displays the current trust mode setting for a specific interface.
show interfaces cos-queue	Displays the class-of-service queue configuration for the specified interface.

Interface Configuration

Use the **Interface Configuration** page to specify ports individually for CoS configuration and to apply an interface shaping rate to the selected ports.

To display the Interface Configuration page, click **Quality of Service** → **Class of Service** → **Interface Configuration** in the tree view.

Figure 11-18. Interface Configuration

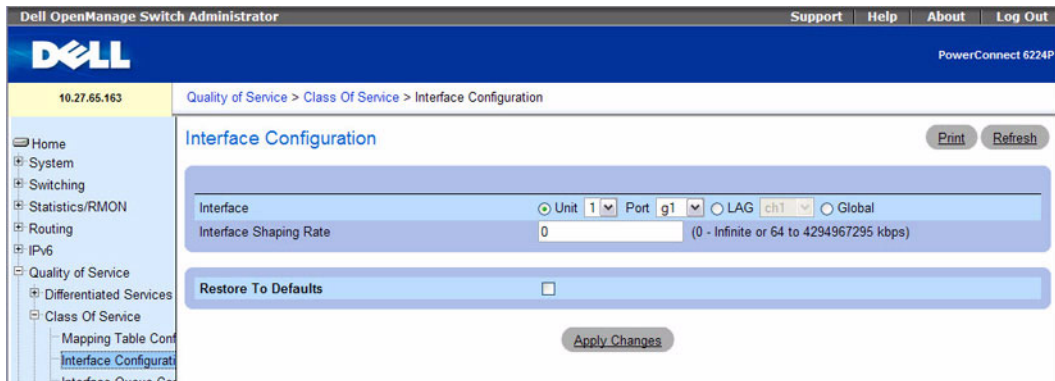

The **Interface Configuration** page contains the following fields:

- **Interface** — Selects the interface to be affected by the **Interface Shaping Rate**. Select **Unit/Port**, or **LAG** to be affected from the drop-down menu. Select **Global** to specify all interfaces.

- **Interface Shaping Rate** — Sets the cap on how much traffic can leave a port. The specified value represents the maximum negotiated bandwidth in kilobit per second (Kbps). The range is 0 - Infinity or 64 to 4294967295 kbps.
- **Restore to Defaults** — Restores the default interface shaping rate to the selected interfaces when checked.

Defining Interface Configuration

1. Open the **Interface Configuration** page.
2. Select the unit and port or LAG to be affected, or select Global to apply the settings to all interfaces.
3. Enter an **Interface Shaping Rate** to apply to these ports.
4. Click **Apply Changes**.
The new **Interface Shaping Rate** is applied to the selected interface(s) and the device is updated.

Restoring Default Shaping Rate

1. Open the **Interface Configuration** page.
2. Click the **Restore to Defaults** check box.
3. Click **Apply Changes**.

All ports are restored to the default shaping rate, and the device is updated.

Defining Interface Configuration Using CLI Commands

For information about the CLI commands that perform this function, see the following chapter in the *CLI Reference Guide*:

- [QoS Commands](#)

The following table summarizes the equivalent CLI commands for this feature.

Table 11-9. Interface Configuration Commands

CLI Command	Description
traffic-shape	Specifies the maximum transmission bandwidth limit for the interface as a whole.

Interface Queue Configuration

Use the **Interface Queue Configuration** page to define what a particular queue does by configuring switch egress queues. User-configurable parameters control the amount of bandwidth used by the queue, the queue depth during times of congestion, and the scheduling of packet transmission from the set of all queues on a port. Each port has its own CoS queue-related configuration.

The configuration process is simplified by allowing each CoS queue parameter to be configured globally or per-port. A global configuration change is automatically applied to all ports in the system.

To display the **Interface Queue Configuration** page, click **Quality of Service** → **Class of Service** → **Interface Queue Configuration** in the tree view.

Figure 11-19. Interface Queue Configuration

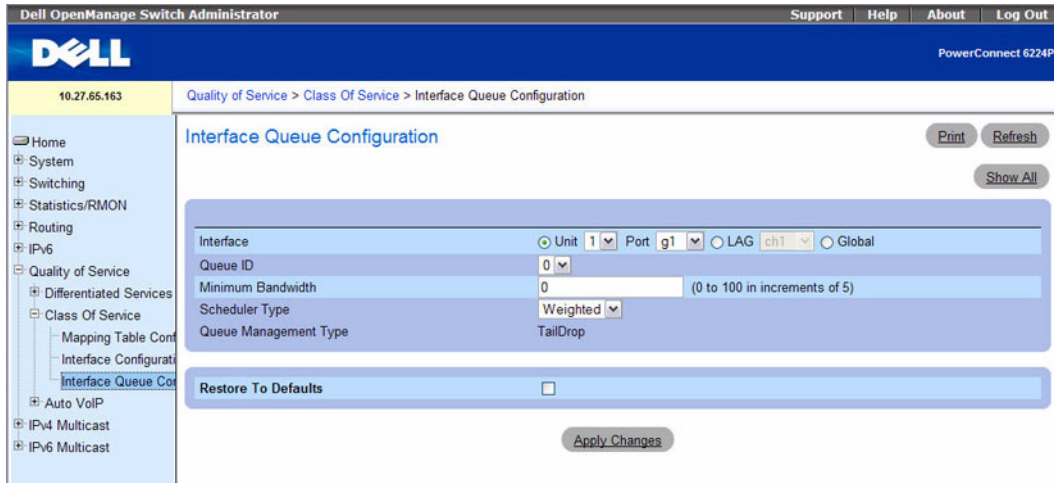

The **Interface Queue Configuration** page contains the following fields:

- **Interface** — Specifies the **Interface** (Unit/Port, LAG, or Global) that's being configured.
- **Queue ID** — Selects the queue to be configured from the drop-down menu.
- **Minimum Bandwidth** — Selects a percentage of the maximum negotiated bandwidth for the port. Specify a percentage from 0 to 100, in increments of 5.
- **Scheduler Type** — Selects the type of queue processing from the drop-down menu. Options are **Weighted** and **Strict**. Defining on a per-queue basis allows the user to create the desired service characteristics for different types of traffic.
 - **Weighted** — Weighted round robin associates a weight to each queue. This is the default.
 - **Strict** — Strict priority services traffic with the highest priority on a queue first.
- **Queue Management Type** — Displays the type of packet management used for all packets, which is Taildrop. All packets on a queue are safe until congestion occurs. At this point, any additional packets queued are dropped.

Configuring an Interface Queue

1. Open the **Interface Queue Configuration** page.
2. Select the port to be affected from the **Interface Unit** and **Port** drop-down menus.
3. Use the remaining fields to configure the queue and its settings for this port.
4. Click **Apply Changes**.

The queue is configured, and the device is updated.

Displaying Interface Queue Settings

1. Open the **Interface Queue Configuration** page.
2. Click **Show All**.
The **Interface Queue Status** page displays.
3. Select **Unit / Port, LAG, or Global**.

Figure 11-20. Interface Queue Status

Queue ID	Minimum Bandwidth	Scheduler Type	Queue Management Type
0	0	Weighted	TailDrop
1	0	Weighted	TailDrop
2	0	Weighted	TailDrop
3	0	Weighted	TailDrop
4	0	Weighted	TailDrop
5	0	Weighted	TailDrop
6	0	Weighted	TailDrop

Configuring an Interface Queue Using CLI Commands

For information about the CLI commands that perform this function, see the following chapter in the *CLI Reference Guide*:

- **QoS Commands**

The following table summarizes the equivalent CLI commands for this feature.

Table 11-10. Interface Queue Configuration Commands

CLI Command	Description
cos-queue min-bandwidth	Specifies the minimum transmission bandwidth for each interface queue.
cos-queue strict	Activates the strict priority scheduler mode for each specified queue.

Auto VoIP

Voice over Internet Protocol (VoIP) allows you to make telephone calls using a computer network over a data network like the Internet. With the increased prominence of delay-sensitive applications (voice, video, and other multimedia applications) deployed in networks today, proper QoS configuration will ensure high-quality application performance. The Auto VoIP feature is intended to provide an easy classification mechanism for voice packets so that they can be prioritized above data packets in order to provide better QoS.

The Auto VoIP feature explicitly matches VoIP streams in Ethernet switches and provides them with a better class of service than ordinary traffic. If you enable the Auto VoIP feature on an interface, the interface scans incoming traffic for the following call-control protocols:

- Session Initiation Protocol (SIP)
- H.323
- Skinny Client Control Protocol (SCCP)

When a call-control protocol is detected the switch assigns the traffic in that session to the highest CoS queue, which is generally used for time-sensitive traffic.

To display the page, click **Quality of Service** → **Auto VoIP** in the tree view. The **Auto VoIP** menu page contains links to the following pages:

- Auto VoIP Global Configuration
- Auto VoIP Interface Configuration

Auto VoIP Global Configuration

Use the Auto VoIP Configuration page to configure the Auto VoIP settings on the switch.

To display the Auto VoIP Configuration page, click **Quality of Service** → **Auto VoIP** → **Global Configuration** in the navigation menu.

Figure 11-21. Auto VoIP Configuration

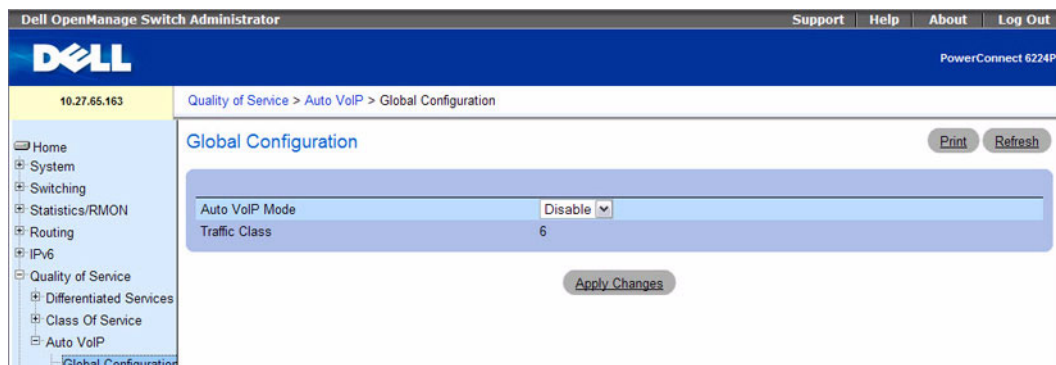

The Auto VoIP Configuration page contains the following fields:

- **Auto VoIP Mode** — Enables or Disables Auto VoIP mode. The default is Disable.
- **Traffic Class** — Displays the traffic class used for VoIP traffic.

Configuring Auto VoIP Using CLI Commands

For information about the CLI commands that perform this function, see the following chapter in the *CLI Reference Guide*:

- **QoS Commands**

The following table summarizes the equivalent CLI commands for this feature.

Table 11-11. Auto VoIP Configuration Commands

CLI Command	Description
switchport voice detect auto	Enables the VoIP Profile on all the interfaces of the switch.

Auto VoIP Interface Configuration

Use the Auto VoIP Interface Configuration page to configure the Auto VoIP settings for each interface.

To display the Auto VoIP Configuration page, click **Quality of Service** → **Auto VoIP** → **Interface Configuration** in the navigation menu.

Figure 11-22. Auto VoIP Interface Configuration

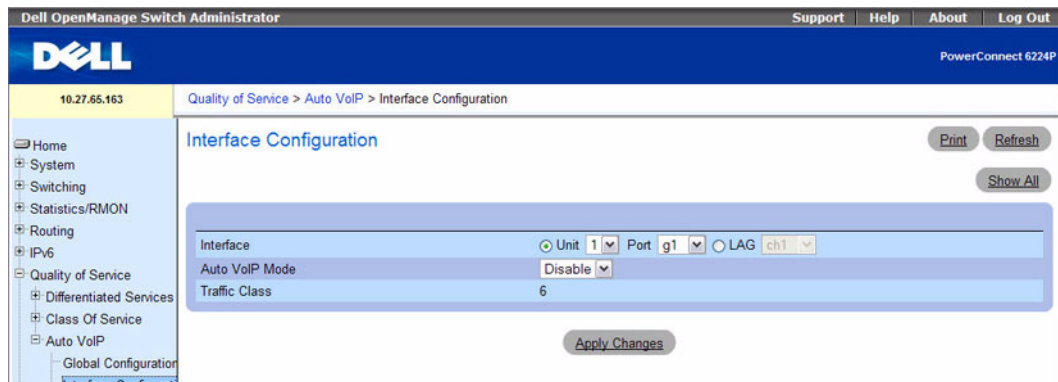

The Auto VoIP Interface Configuration page contains the following fields:

- **Interface** — Lists the interfaces, Unit and Port or LAG, on which Auto VoIP can be configured.
- **Auto VoIP Mode** — Use the mode setting to either Enable or Disable the Auto VoIP mode on the selected interface. The default is Disable.
- **Traffic Class** — Displays the traffic class used for VoIP traffic.

Viewing the Auto VoIP Summary Table

1. Open the Auto VoIP Interface Configuration page.
2. Click Show All.

The Auto VoIP Summary page opens.

Figure 11-23. Auto VoIP Summary

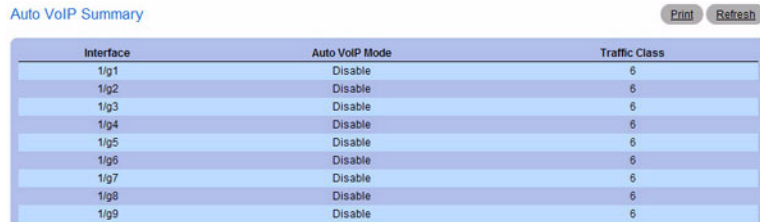

Interface	Auto VoIP Mode	Traffic Class
1/g1	Disable	6
1/g2	Disable	6
1/g3	Disable	6
1/g4	Disable	6
1/g5	Disable	6
1/g6	Disable	6
1/g7	Disable	6
1/g8	Disable	6
1/g9	Disable	6

Configuring Auto VoIP Interfaces Using CLI Commands

For information about the CLI commands that perform this function, see the following chapter in the *CLI Reference Guide*:

- QoS Commands

The following table summarizes the equivalent CLI commands for this feature.

Table 11-12. AutoVoIP Interface Commands

CLI Command	Description
switchport voice detect auto	Enables the VoIP Profile on all the specified interface.
show switchport voice	Displays the status of auto-voip on an interface or all interfaces.

Configuring IP Multicast

Overview

This chapter describes how to configure IPv4 and IPv6 multicast features on the PowerConnect 6200 Series.

To display the **IPv4 Multicast** menu page, click **IPv4 Multicast** in the tree view. The **IPv4 Multicast** menu page contains links to the following features:

- Multicast
- Distance Vector Multicast Routing Protocol
- Internet Group Management Protocol
- Protocol Independent Multicast

To display the **IPv6 Multicast** menu page, click **IPv6 Multicast** in the tree view. The **IPv6 Multicast** menu page contains links to the following features:

- Multicast
- Multicast Listener Discovery
- Protocol Independent Multicast

Multicast protocols are used to deliver Multicast packets from one source to multi receivers. They facilitate better bandwidth utilization, less host and router processing, making them ideal for usage in applications like video or audio conferencing, Whiteboard tools, stock distribution tickers etc.

Multicast applications send one copy of a packet, and address it to a group of receivers (Multicast Group Address) rather than to a single receiver (unicast address). Multicast depends on the network to forward the packets to only those networks and hosts that need to receive them.

Multicast capable/enabled routers forward multicast packets based on the routes in the Multicast Routing Information Base (MRIB). These routes are created in the MRIB during the process of building multicast distribution trees by the Multicast Protocols running on the router. Different IP Multicast routing protocols use different techniques to construct these multicast distribution trees.

If Multicast traffic is to be routed through a part of a network that does not support multicasting (routers which are not multicast capable) then the multicast packets are encapsulated in an IP datagram and sent as a unicast packet. When the multicast router at the remote end of the tunnel receives the packet, the router strips off the IP encapsulation and forwards the packet as an IP Multicast packet. This process of encapsulating multicast packets in IP is called tunneling.

Multicast

The **IPv4 Multicast** menu page contains links to web pages that define and display **Multicast** parameters and data. To display this page, click **IPv4 Multicast** → **Multicast** in the tree view. Following are the web pages accessible from this menu page:

- Multicast Global Configuration
- Multicast Interface Configuration
- Multicast Static MRoute Configuration
- Multicast Static MRoute Summary
- Multicast Admin Boundary Configuration
- Multicast Admin Boundary Summary

 **NOTE:** The IPv6 Multicast menu contains a link to the IPv6 Multicast Route Table.

Multicast Global Configuration

Use the **Multicast Global Configuration** page to configure the administrative status of Multicast Forwarding in the router, and to display global multicast parameters.

To display the page, click **IPv4 Multicast** → **Multicast** → **Global Configuration** in the tree view.

Figure 12-1. Multicast Global Configuration

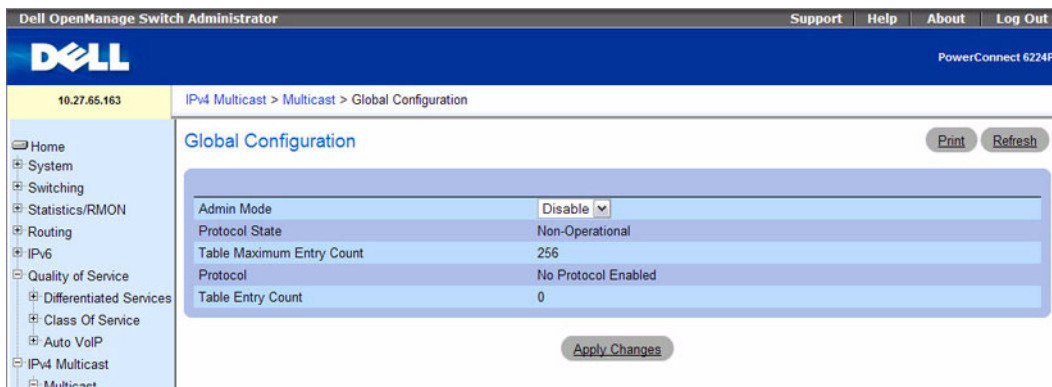

The **Multicast Global Configuration** page contains the following fields:

- **Admin Mode** — Select Enable or Disable to set the administrative status of Multicast Forwarding in the router. The default is Disable.
- **Protocol State** — The operational state of the multicast forwarding module.
- **Table Maximum Entry Count** — The maximum number of entries in the IP Multicast routing table.
- **Protocol** — The multicast routing protocol presently activated on the router, if any.
- **Table Entry Count** — The number of multicast route entries currently present in the Multicast route table.

Configuring Multicast Forwarding Administrative Mode

1. Open the **Multicast Global Configuration** page.
2. Select Enable or Disable for the **Admin Mode**.
3. Click **Apply Changes**.

The multicast global configuration is saved, and the device is updated.

Configuring/Displaying Multicast Forwarding Parameters Using CLI Commands

For information about the CLI commands that perform this function, see the following chapter in the *CLI Reference Guide*:

- Multicast Commands

The following table summarizes the equivalent CLI commands for this feature.

Table 12-1. Multicast Global Commands

CLI Command	Description
ip multicast	Sets the administrative mode of the IP multicast forwarder in the router to active.
ip mroute	Creates a static multicast route for a source range.
ip multicast	Set the administrative mode of the IP multicast forwarder in the router to active.
ip pimsm bsr-candidate	Configures the router to announce its candidacy as a bootstrap router (BSR).
ip pimsm register-threshold	Configures the Register Threshold rate for the RP router to switch to the shortest path.
ip pimsm rp-address	Statically configures the RP address for one or more multicast groups.
ip pimsm rp-candidate	Configures the router to advertise itself as a PIM candidate rendezvous point (RP) to the bootstrap router (BSR).

Table 12-1. Multicast Global Commands (continued)

CLI Command	Description
ip pimsm spt-threshold	Configures the Data Threshold rate for the last hop router to switch to the shortest path.
ip pimsm ssm	Defines the Source Specific Multicast (SSM) range of IP multicast addresses.
show ip mcast	Displays the system-wide multicast information.
show ip mcast boundary	Displays all the configured administrative scoped multicast boundaries.
show ip mcast interface	Displays the multicast information for the specified interface.
show ip mcast mroute	Displays a summary or all the details of the multicast table.
show ip mcast mroute group	Displays the multicast configuration settings such as flags, timer settings, incoming and outgoing interfaces, RPF neighboring routers, and expiration times of all the entries in the multicast mroute table containing the groupipaddr value.
show ip mcast mroute source	Displays the multicast configuration settings such as flags, timer settings, incoming and outgoing interfaces, RPF neighboring routers, and expiration times of all the entries in the multicast mroute table containing the sourceipaddr or sourceipaddr groupipaddr pair value(s).
show ip mcast mroute static	Displays all the static routes configured in the static mcast table if it is specified or display the static route associated with the particular sourceipaddr.
show ip pimsm bsr	Displays the bootstrap router (BSR) information.
show ip pimsm interface	Displays interface config parameters.
show ip pimsm rphash	Displays which rendezvous point (RP) is being selected for a specified group.
show ip pimsm rp mapping	Displays all group-to-RP mappings of which the router is aware (either configured or learned from the bootstrap router (BSR)).

Multicast Interface Configuration

Use the **Multicast Interface Configuration** page to configure the TTL threshold of a multicast interface. You must configure at least one router interface before fields display on this page.

To display the page, click **IPv4 Multicast** → **Multicast** → **Interface Configuration** in the tree view.

Figure 12-2. Multicast Interface Configuration

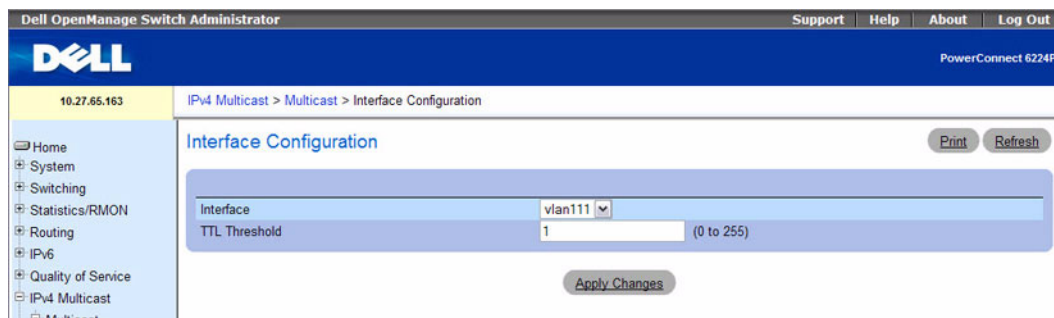

The **Multicast Interface Configuration** page contains the following fields:

- **Interface** — Select the routing interface you want to configure from the drop-down menu.
- **TTL Threshold** — Enter the TTL threshold below which a multicast data packet is not forwarded from the selected interface. Enter a number between 0 and 255. If you enter 0, all multicast packets for the selected interface are forwarded. You must configure at least one router interface to see this field.

Configuring a Multicast Interface

1. Open the **Multicast Interface Configuration** page.
2. Select the interface to configure from the **Interface** drop-down menu.
3. Enter the desired **TTL Threshold**.
4. Click **Apply Changes**.

The multicast interface configuration is saved, and the device is updated.

Configuring a Multicast Interface Using CLI Commands

For information about the CLI command that performs this function, see the following chapter in the *CLI Reference Guide*:

- Multicast Commands

The following table summarizes the equivalent CLI commands for this feature.

Table 12-2. Multicast Interface Configuration Commands

CLI Command	Description
ip multicast ttl-threshold	Applies a <i>ttlvalue</i> to a routing interface.
show ip mcast interface	Displays the multicast information for the specified interface.

Multicast Route Table

Use the Multicast Route Table page is used to display MRoute data.

To display the page, click IPv4 Multicast → Multicast → Multicast Route Table or IPv6 Multicast → Multicast → Multicast Route Table.

Figure 12-3. Multicast Route Table

The screenshot shows the Dell OpenManage Switch Administrator interface. The breadcrumb navigation is IPv6 Multicast > Multicast > Multicast Route Table. The main content area displays a table titled "Multicast Route Table" with the following data:

Group IP	Source IP	Incoming Interface	Outgoing Interfaces	Up Time(hh:mm:ss)	Expiry Time(hh:mm:ss)	RPF Neighbor	Protocol	Flags
FF1E:3	2002:2	vlan10	vlan10	00:00:33	00:00:00	⋮	PIMSM	RPT
FF1E:4	2002:2	vlan10	vlan10	00:00:33	00:00:00	⋮	PIMSM	RPT
FF1E:5	2002:2	vlan10	vlan10	00:00:33	00:00:00	⋮	PIMSM	RPT
FF1E:6	2002:2	vlan10	vlan10	00:00:33	00:00:00	⋮	PIMSM	RPT
FF1E:7	2002:2	vlan10	vlan10	00:00:33	00:00:00	⋮	PIMSM	RPT
FF1E:8	2002:2	vlan10	vlan10	00:00:33	00:00:00	⋮	PIMSM	RPT
FF1E:9	2002:2	vlan10	vlan10	00:00:33	00:00:00	⋮	PIMSM	RPT
FF1E:A	2002:2	vlan10	vlan10	00:00:33	00:00:00	⋮	PIMSM	RPT
FF1E:B	2002:2	vlan10	vlan10	00:00:33	00:00:00	⋮	PIMSM	RPT
FF1E:C	2002:2	vlan10	vlan10	00:00:33	00:00:00	⋮	PIMSM	RPT

The Multicast Route Table page contains the following fields:

- **Group IP** — The destination group IP address.
- **Source IP** — The IP address of the multicast packet source that, combined with the Group IP, identifies an multicast route table entry.
- **Incoming Interface** — The incoming interface on which multicast packets for this source/group arrive.

- **Outgoing Interfaces** — The list of outgoing interfaces on which multicast packets for this source/group are forwarded.
- **Up Time** — The time in hours:minutes:seconds since the entry was created.
- **Expiry Time** — The time in hours:minutes:seconds before this entry ages out and is removed from the table.
- **RPF Neighbor** — The IP address of the Reverse Path Forwarding neighbor.
- **ProtocolFlags** — The multicast routing protocol which created this entry. The possibilities are:
 - PIM-DM
 - PIM-SM
 - DVMRP
- **Flags** — The value displayed in this field is valid if the multicast routing protocol running is PIM-SM. The possible values are RPT or SPT. For other protocols a “-----” (no value) is displayed.

Viewing the Multicast Route Table Using CLI Commands

For information about the CLI command that performs this function, see the following chapter in the *CLI Reference Guide*:

- Multicast Commands

The following table summarizes the equivalent CLI commands for this feature.

Table 12-3. Multicast Table Command

CLI Command	Description
show ip mcast mroute	Displays a summary or all the details of the multicast table.
show bridge multicast address-table count	Displays statistical information about the entries in the multicast address table.
show ip mcast mroute group	Displays the multicast configuration settings of entries in the multicast mroute table.
show ip mcast mroute source	Displays the multicast configuration settings of entries in the multicast mroute table.

Multicast Admin Boundary Configuration

The definition of an administratively scoped boundary is a way to stop the ingress and egress of multicast traffic for a given range of multicast addresses on a given routing interface. Use the **Multicast Admin Boundary Configuration** page to configure a new or existing administratively scoped boundary. To see this page, you must have configured a valid routing interface and multicast.

To display the page, click **IPv4 Multicast** → **Multicast** → **Admin Boundary Configuration** in the tree view.

Figure 12-4. Multicast Admin Boundary Configuration

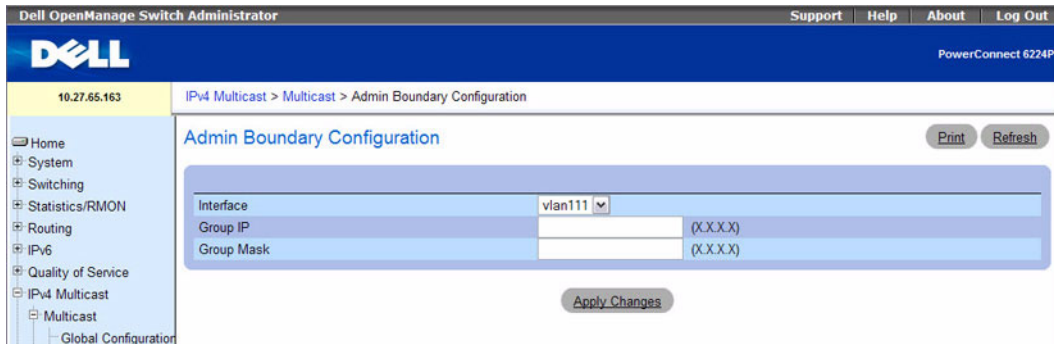

The **Multicast Admin Boundary Configuration** page contains the following fields:

- **Interface** — Select the router interface for which the administratively scoped boundary is to be configured.
- **Group IP** — Enter the multicast group address for the start of the range of addresses to be excluded. The address must be in the range of 239.0.0.0 through 239.255.255.255.
- **Group Mask** — Enter the mask to be applied to the multicast group address. The combination of the mask and the Group IP gives the range of administratively scoped addresses for the selected interface.

Configuring an Admin Boundary Using CLI Commands

For information about the CLI command that performs this function, see the following chapter in the *CLI Reference Guide*:

- Multicast Commands

The following table summarizes the equivalent CLI commands for this feature.

Table 12-4. Multicast Admin Boundary Configuration Command

CLI Command	Description
ip mcast boundary	Adds an administrative scope multicast boundary.

Multicast Admin Boundary Summary

Use the Multicast Admin Boundary Summary page to display existing administratively scoped boundaries.

To display the page, click IPv4 Multicast → Multicast → Admin Boundary Summary in the tree view.

Figure 12-5. Multicast Admin Boundary Summary

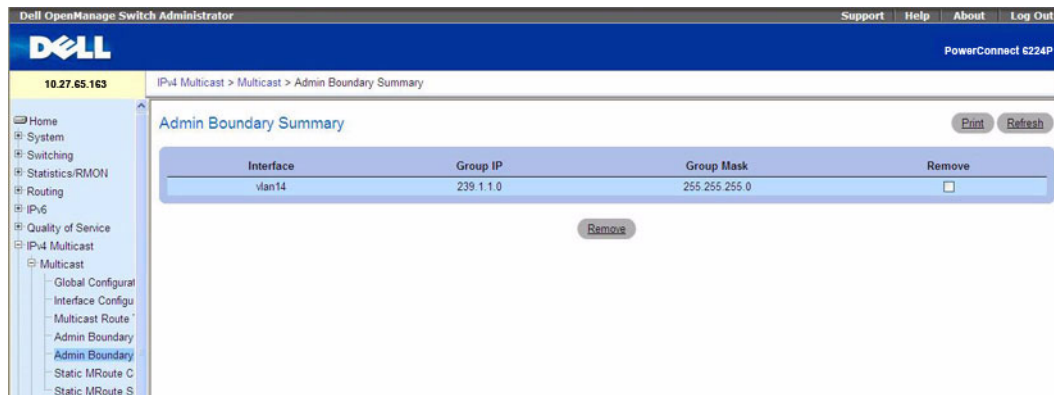

The Multicast Admin Boundary Summary page displays the following fields:

- **Interface** — The router interface to which the administratively scoped address range is applied.
- **Group IP** — The multicast group address for the start of the range of addresses to be excluded.
- **Group Mask** — The mask that is applied to the multicast group address. The combination of the mask and the Group IP gives the range of administratively scoped addresses for the selected interface.

Displaying the Multicast Admin Boundary Summary Using CLI Commands

For information about the CLI command that performs this function, see the following chapter in the *CLI Reference Guide*:

- Multicast Commands

The following table summarizes the equivalent CLI commands for this feature.

Table 12-5. Multicast Admin Boundary Summary Command

CLI Command	Description
show ip mcast boundary	Displays the system-wide multicast information.

Multicast Static MRoute Configuration

Use the Multicast Static MRoute Configuration page to configure a new static entry in the Mroute table or to modify an existing entry.

To display the page, click IPv4 Multicast → Multicast → Static MRoute Configuration in the tree view.

Figure 12-6. Multicast Static Routes Configuration

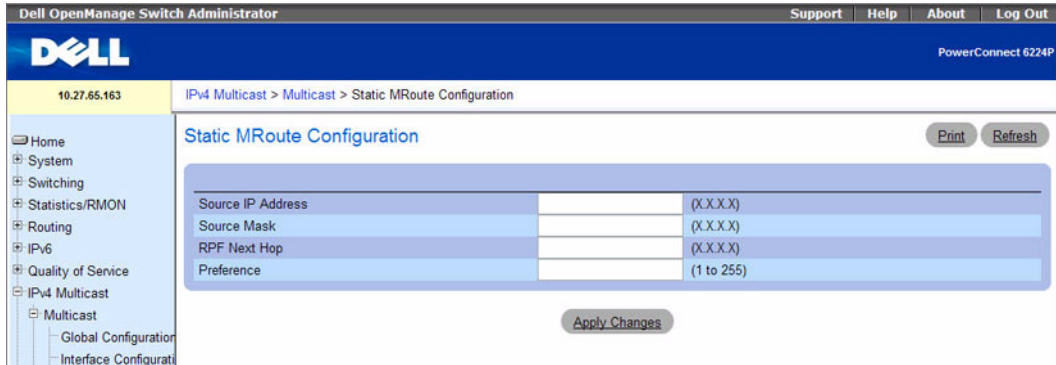

The Multicast Static MRoute Configuration page contains the following fields:

- **Source IP** — Enter the IP Address that identifies the multicast packet source for the entry you are creating.
- **Source Mask** — Enter the subnet mask to be applied to the Source IP address.
- **RPF Next Hop**— Enter the IP address of the neighbor router on the path to the source.
- **Preference** — Enter the preference with which the static mroute to be considered against other matching static mroute entry for a given source. The values should range from 1 to 255.

Configuring a Static Route

1. Open the **Static Routes** page.
2. Modify the fields as needed.
3. Click **Apply Changes**.

The new or modified static route is saved, and the device is updated.

Configuring a Static Route the CLI Commands

For information about the CLI commands that perform this function, see the following chapter in the *CLI Reference Guide*:

- Multicast Commands

The following table summarizes the equivalent CLI commands for this feature.

Table 12-6. Multicast Static Route Configuration Commands

CLI Command	Description
ip mroute	Creates a static multicast route for a source range.

Multicast Static MRoute Summary

Use the Multicast Static Routes Summary page to display static routes and their configurations. To display the page, click IPv4 Multicast → Multicast → Static MRoute Summary in the tree view.

Figure 12-7. Multicast Static Routes Summary

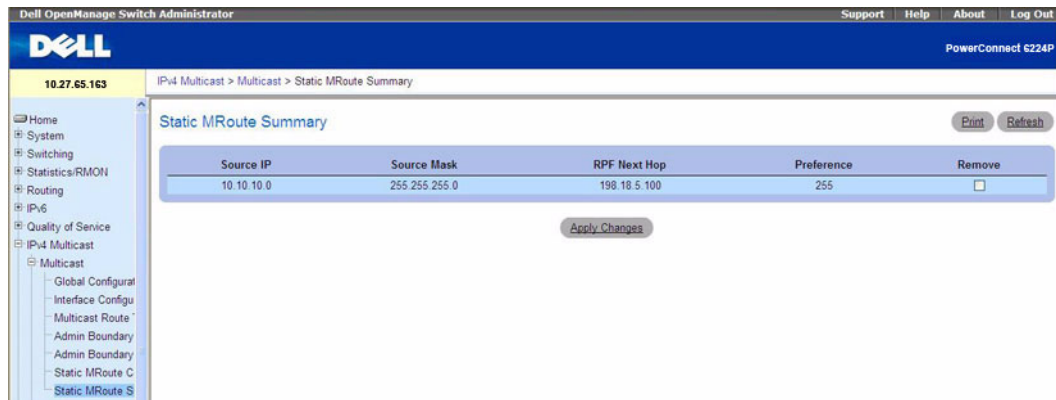

The Multicast Static MRoute Summary page displays the following fields:

- **Source IP** — The IP Address that identifies the multicast packet source for this route.
- **Source Mask** — The subnet mask applied to the Source IP address.
- **RPF Address** — The IP address of the RPF neighbor.
- **Preference** — Enter the preference with which the static mroute to be considered against other matching static mroute entry for a given source. The values should range from 1 to 255.

Displaying the Static Routes Summary Using CLI Commands

For information about the CLI command that performs this function, see the following chapter in the *CLI Reference Guide*:

- Multicast Commands

The following table summarizes the equivalent CLI commands for this feature.

Table 12-7. Multicast Static Route Summary Command

CLI Command	Description
show ip mcast mroute static	Displays all the static routes configured in the static mcast table.

Distance Vector Multicast Routing Protocol

Distance Vector Multicast Routing Protocol (DVMRP) exchanges probe packets with all its DVMRP enabled routers, it establishes two way neighboring relationships, and it builds a neighbor table. It exchanges report packets and creates a unicast topology table, with which it builds the multicast routing table. This table is used to route the multicast packets. Since every DVMRP router uses the same unicast routing protocol, routing loops are avoided.

The **DVMRP** menu page contains links to web pages that define and display DVMRP parameters and data. To display this page, click **IPv4 Multicast** → **DVMRP** in the tree view.

The following web pages are accessible from this menu page:

- DVMRP Global Configuration
- DVMRP Interface Configuration
- DVMRP Configuration Summary
- Next Hop Summary
- Prune Summary
- Route Summary

DVMRP Global Configuration

Use the **DVMRP Global Configuration** page to configure global DVMRP settings.

To display the page, click **IPv4 Multicast** → **DVMRP** → **Global Configuration** in the tree view.

Figure 12-8. DVMRP Global Configuration

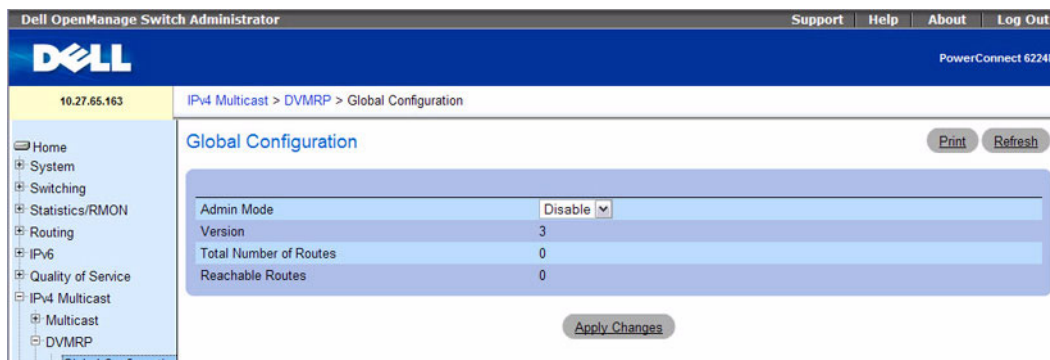

The **DVMRP Global Configuration** page contains the following fields:

- **Admin Mode** — Select Enable or Disable from the drop-down menu. This sets the administrative status of DVMRP to active or inactive. The default is Disable.
- **Version** — The current value of the DVMRP version string.

- **Total Number of Routes** — The number of routes in the DVMRP routing table.
- **Reachable Routes** — The number of routes in the DVMRP routing table that have a non-infinite metric.

Setting the DVMRP Admin Mode

1. Open the **DVMRP Global Configuration** page.
2. Set **Admin Mode** to **Enable** or **Disable**, to turn DVMRP on or off.
3. Click **Apply Changes**.

The DVMRP configuration is saved, and the device is updated.

Configuring DVMRP Using CLI Commands

For information about the CLI commands that perform this function, see the following chapter in the *CLI Reference Guide*:

- **DVMRP Commands**

The following table summarizes the equivalent CLI commands for this feature.

Table 12-8. DVMRP Global Commands

CLI Command	Description
ip dvmrp	Sets the administrative mode of DVMRP in the router to active.
show ip dvmrp	Displays the system-wide information for DVMRP.
ip dvmrp trapflags	Enables the DVMRP trap mode.

DVMRP Interface Configuration

Use the **DVMRP Interface Configuration** page to configure a DVMRP interface. You must configure at least one router interface before you configure a DVMRP interface. Otherwise you see a message telling you that no router interfaces are available, and the configuration screen is not displayed.

To display the page, click **IPv4 Multicast** → **DVMRP** → **Interface Configuration** in the tree view.

Figure 12-9. DVMRP Interface Configuration

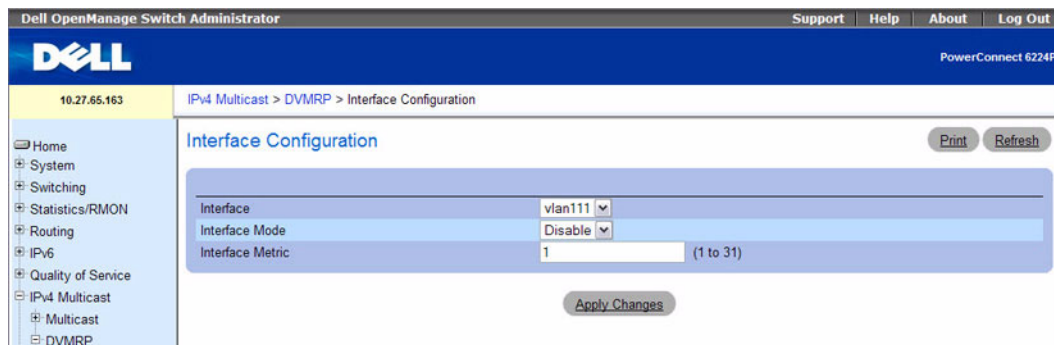

The **DVMRP Interface Configuration** page contains the following fields:

- **Interface** — Select the interface for which data is to be configured. You must configure at least one router interface before you configure a DVMRP interface.
- **Interface Mode** — Select Enable or Disable from the drop-down menu to set the administrative mode of the selected DVMRP routing interface.
- **Interface Metric** — Enter the DVMRP metric for the selected interface. This value is sent in DVMRP messages as the cost to reach this network. Valid values are from 1 to 31.

Configuring a DVMRP Interface

1. Open the **DVMRP Interface Configuration** page.
2. Select the interface to configure from the **Interface** field.
3. Modify the remaining fields as needed.
4. Click **Apply Changes**.

The interface configuration is saved, and the device is updated.

Configuring a DVMRP Interface Using CLI Commands

For information about the CLI commands that perform this function, see the following chapter in the *CLI Reference Guide*:

- DVMRP Commands

The following table summarizes the equivalent CLI commands for this feature.

Table 12-9. DVMRP Interface Commands

CLI Command	Description
ip dvmrp metric	Configures the metric for an interface.

DVMRP Configuration Summary

Use the DVMRP Configuration Summary page to display or print the DVMRP configuration and data for a selected interface. You must configure at least one router interface before you can display data for a DVMRP interface. Otherwise you see a message telling you that no router interfaces are available, and the configuration summary screen is not displayed.

To display the page, click IPv4 Multicast → DVMRP → Configuration Summary in the tree view.

Figure 12-10. DVMRP Configuration Summary

The screenshot shows the Dell OpenManage Switch Administrator interface. The top navigation bar includes 'Support', 'Help', 'About', and 'Log Out'. The main header displays the Dell logo and the device name 'PowerConnect 6224P'. The breadcrumb path is 'IPv4 Multicast > DVMRP > Configuration Summary'. The left sidebar contains a tree view with categories like Home, System, Switching, Statistics/RMON, Routing, IPv6, Quality of Service, IPv4 Multicast, Multicast, DVMRP, IGMP, PIM, and IPv6 Multicast. The 'DVMRP' section is expanded, showing 'Global Configuration', 'Interface Configuration', 'Configuration Summary', 'Next Hop Summary', 'Prune Summary', and 'Route Summary'. The 'Configuration Summary' page is active, showing a dropdown menu for 'Interface' set to 'vian111'. Below this are three sections: 'Interface Parameters', 'Interface Statistics', and 'Neighbor Parameters'. The 'Interface Parameters' section shows: Interface Mode (Disable), Protocol State (Non-Operational), Local Address (9.25.67.1), and Interface Metric (1). The 'Interface Statistics' section shows: Generation ID, Received Bad Packets (0), Received Bad Routes (0), and Sent Routes (0). The 'Neighbor Parameters' section shows a dropdown for 'Neighbor IP' and fields for State, Neighbor Uptime, Neighbor Expiry Time, Generation ID, Major Version, Minor Version, Capabilities, Received Routes, Received Bad Packets, and Received Bad Routes.

The DVMRP Configuration Summary page contains the following fields:

- **Interface** — Select the interface for which data is to be displayed. You must configure at least one router interface before you can display data for a DVMRP interface.

Interface Parameters

- **Interface Mode** — Displays the administrative mode of the selected DVMRP routing interface, either Enable or Disable.

- **Protocol State** — Displays the operational state of the DVMRP protocol on the selected interface, either Operational or Non-operational.
- **Local Address** — Displays the IP address used as a source address in packets sent from the selected interface.
- **Interface Metric** — Displays the metric used to calculate distance vectors for the selected interface.

Interface Statistics

- **Generation ID** — Displays the DVMRP generation ID used by the router for the selected interface. This value is reset every time an interface is (re)started and is placed in prune messages. A change in generation ID informs the neighbor routers that any previous information about this router should be discarded.
- **Received Bad Packets** — The number of invalid packets received on the selected interface.
- **Received Bad Routes** — The number of invalid routes received on the selected interface.
- **Sent Routes** — The number of routes sent on the selected interface.

Neighbor Parameters

- **Neighbor IP** — The IP address of the neighbor whose information is displayed.
- **State** — The state of the specified neighbor router on the selected interface, either active or down.
- **Neighbor Uptime** — The DVMRP uptime for the specified neighbor on the selected interface. This is the time since the neighbor entry was learned.
- **Neighbor Expiry Time** — The DVMRP expiry time for the specified neighbor on the selected interface. This is the time left before this neighbor entry ages out, and is not applicable if the neighbor router's state is down.
- **Generation ID** — The DVMRP generation ID for the specified neighbor on the selected interface.
- **Major Version** — The DVMRP Major Version for the specified neighbor on the selected interface.
- **Minor Version** — The DVMRP Minor Version for the specified neighbor on the selected interface.
- **Capabilities** — The DVMRP capabilities of the specified neighbor on the selected interface.
- **Received Routes** — The number of routes received for the specified neighbor on the selected interface.
- **Received Bad Packets** — The number of invalid packets received for the specified neighbor on the selected interface.
- **Received Bad Routes** — The number of invalid routes received for the specified neighbor on the selected interface.

Displaying DVMRP Configuration Summary Using CLI Commands

For information about the CLI commands that perform this function, see the following chapter in the *CLI Reference Guide*:

- DVMRP Commands

The following table summarizes the equivalent CLI commands for this feature.

Table 12-10. DVMRP Configuration Summary Commands

CLI Command	Description
show ip dvmrp interface	Displays the interface information for DVMRP on the specified interface.
show ip dvmrp neighbor	Displays the neighbor information for DVMRP.

Next Hop Summary

Use the **Next Hop Summary** page to display or print the next hop summary by Source IP. To display the page, click **IPv4 Multicast** → **DVMRP** → **Next Hop Summary** in the tree view.

Figure 12-11. Next Hop Summary

Source IP	Source Mask	Interface	Type
6.6.6.0	255.255.255.0	vlan10	Leaf
6.6.6.0	255.255.255.0	vlan11	Leaf
6.6.6.0	255.255.255.0	vlan13	Leaf
6.6.6.0	255.255.255.0	vlan100	Leaf
198.18.1.0	255.255.255.0	vlan10	Leaf
198.18.1.0	255.255.255.0	vlan11	Leaf
198.18.1.0	255.255.255.0	vlan13	Leaf
198.18.2.0	255.255.255.0	vlan100	Branch
198.18.2.0	255.255.255.0	vlan10	Leaf
198.18.2.0	255.255.255.0	vlan11	Leaf
198.18.2.0	255.255.255.0	vlan13	Leaf
198.18.2.0	255.255.255.0	vlan100	Branch
198.18.4.0	255.255.255.0	vlan10	Leaf
198.18.4.0	255.255.255.0	vlan11	Leaf
198.18.4.0	255.255.255.0	vlan13	Leaf
198.18.4.0	255.255.255.0	vlan100	Branch

The **Next Hop Summary** page displays the following fields:

- **Source IP** — Displays the IP address used with the source mask to identify the source network for this table entry.
- **Source Mask** — Displays the network mask used with the source IP address.
- **Next Hop Interface** — Displays the outgoing interface for this next hop.
- **Type** — Displays the next hop type. Leaf means that no downstream dependent neighbors exist on the outgoing interface. Otherwise, the type is Branch.

Displaying the Next Hop Summary Using CLI Commands

For information about the CLI commands that perform this function, see the following chapter in the *CLI Reference Guide*:

- DVMRP Commands

The following table summarizes the equivalent CLI commands for this feature.

Table 12-11. DVMRP Next Hop Command

CLI Command	Description
show ip dvmrp nexthop	Displays the next hop information on outgoing interfaces for routing multicast datagrams.

Prune Summary

Use the **Prune Summary** page to display or print the prune summary by Group IP.

To display the page, click **IPv4 Multicast** → **DVMRP** → **Prune Summary** in the tree view.

Figure 12-12. Prune Summary

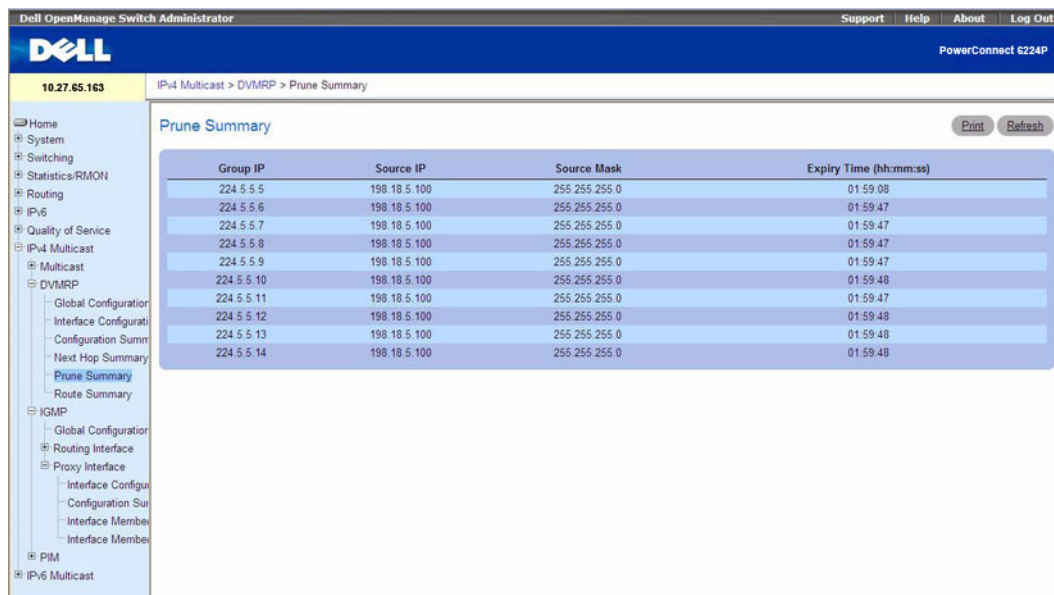

The screenshot shows the Dell OpenManage Switch Administrator interface. The breadcrumb navigation is IPv4 Multicast > DVMRP > Prune Summary. The main content area displays a table titled "Prune Summary" with the following data:

Group IP	Source IP	Source Mask	Expiry Time (hh:mm:ss)
224.5.5.5	198.18.5.100	255.255.255.0	01:59:08
224.5.5.6	198.18.5.100	255.255.255.0	01:59:47
224.5.5.7	198.18.5.100	255.255.255.0	01:59:47
224.5.5.8	198.18.5.100	255.255.255.0	01:59:47
224.5.5.9	198.18.5.100	255.255.255.0	01:59:47
224.5.5.10	198.18.5.100	255.255.255.0	01:59:48
224.5.5.11	198.18.5.100	255.255.255.0	01:59:47
224.5.5.12	198.18.5.100	255.255.255.0	01:59:48
224.5.5.13	198.18.5.100	255.255.255.0	01:59:48
224.5.5.14	198.18.5.100	255.255.255.0	01:59:48

The **Prune Summary** page displays the following fields:

- **Group IP** — The group address which has been pruned.
- **Source IP** — The address of the source or source network which has been pruned.

- **Source Mask** — The subnet mask to be combined with the source IP address to identify the source or source network which has been pruned.
- **Expiry Time (secs)** — The amount of time remaining before this prune should expire at the upstream neighbor. If no prune messages have been received from downstream neighbors, this is set to value of the default prune lifetime timer, otherwise it is set to the smallest received value or the default timer, whichever is less.

Displaying the Prune Summary Using CLI Commands

For information about the CLI command that performs this function, see the following chapter in the *CLI Reference Guide*:

- DVMRP Commands

The following table summarizes the equivalent CLI commands for this feature.

Table 12-12. DVMRP Prune Summary Command

CLI Command	Description
show ip dvmrp prune	Displays the table that lists the router's upstream prune information.

Route Summary

Use the **Route Summary** page to display or print the DVMRP route summary.

To display the page, click **IPv4 Multicast** → **DVMRP** → **Route Summary** in the tree view.

Figure 12-13. Route Summary

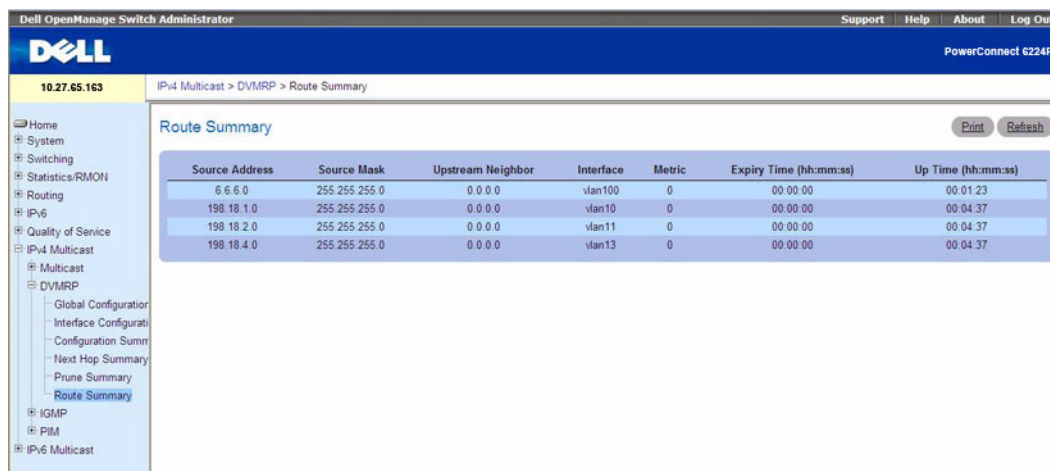

The **Route Summary** page displays the following fields:

- **Source Address** - The network address that is combined with the source mask to identify the sources for this entry.
- **Source Mask** — The subnet mask to be combined with the source address to identify the sources for this entry.
- **Upstream Neighbor** — The address of the upstream neighbor (for example, RPF neighbor) from which IP datagrams from these sources are received.
- **Interface** — The interface on which IP datagrams sent by these sources are received. A value of 0 typically means the route is an aggregate for which no next-hop interface exists.
- **Metric** — The distance in hops to the source subnet.
- **Expiry Time** — The minimum amount of time remaining before this entry is aged out.
- **Up Time** — The time since the route represented by this entry was learned by the router.

Displaying the DVMRP Route Summary Using CLI Commands

For information about the CLI command that performs this function, see the following chapter in the *CLI Reference Guide*:

- DVMRP Commands

The following table summarizes the equivalent CLI commands for this feature.

Table 12-13. DVMRP Route Summary Command

CLI Command	Description
show ip dvmrp route	Displays the multicast routing information for DVMRP.

Internet Group Management Protocol

The Internet Group Management Protocol (IGMP) is used by IPv4 systems (hosts and routers) to report their IP multicast group memberships to any neighboring multicast routers. The PowerConnect 6200 Series performs the multicast router role of the IGMP protocol, which means it collects the membership information needed by the active multicast routing. The currently supported multicast routing protocols in the PowerConnect 6200 Series are DVMRP, PIM-DM, and PIM-SM.

The PowerConnect 6200 Series supports IGMP Version 3. Version 3 adds support for source filtering, which is the ability for a system to report interest in receiving packets only from specific source addresses, as required to support Source-Specific Multicast [SSM], or from all but specific source addresses, sent to a particular multicast address. Version 3 is designed to be interoperable with Versions 1 and 2.

The **IGMP** menu page contains links to web pages that define and display IGMP parameters and data. To display this page, click **IPv4 Multicast** → **IGMP** in the tree view.

Following are the web pages accessible from this menu page:

- IGMP Global Configuration
- Routing Interface
- Proxy Interface

IGMP Global Configuration

Use the **IGMP Global Configuration** page to set IGMP on the system to active or inactive. To display the page, click **IPv4 Multicast** → **IGMP** → **Global Configuration** in the tree view.

Figure 12-14. IGMP Global Configuration

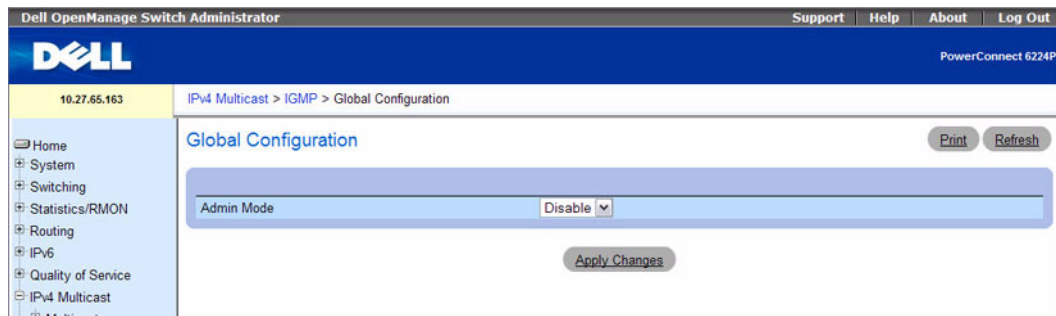

The **IGMP Global Configuration** page contains the following field:

- **Admin Mode** — Select **Enable** or **Disable** from the drop-down menu to set the administrative status of IGMP in the router to active or inactive. The default is **Disable**.

Setting the IGMP Mode

1. Open the **IGMP Global Configuration** page.

2. Set **Admin Mode** to **Enable** or **Disable**, to turn IGMP on or off.
3. Click **Apply Changes**.

The IGMP configuration is saved, and the device is updated.

Setting IGMP Mode Using CLI Commands

For information about the CLI commands that perform this function, see the following chapter in the *CLI Reference Guide*:

- IGMP Commands

The following table summarizes the equivalent CLI commands for this feature.

Table 12-14. IGMP Global Commands

CLI Command	Description
ip igmp	Sets the administrative mode of IGMP in the system to active.
show ip igmp	Displays system-wide IGMP information.

Routing Interface

The **Routing Interface** menu page contains links to web pages that configure and display IGMP routing parameters and data. To display this page, click **IPv4 Multicast** → **IGMP** → **Routing Interface** in the tree view. Following are the web pages accessible from this menu page:

- IGMP Interface Configuration
- IGMP Configuration Summary
- IGMP Cache Information
- IGMP Interface

IGMP Interface Configuration

Use the **IGMP Interface Configuration** page to configure and/or display router interface parameters. You must configure at least one valid routing interface before you can access this page and configure IP Multicast IGMP.

To display the page, click **IPv4 Multicast** → **IGMP** → **Routing Interface** → **Interface Configuration** in the tree view.

Figure 12-15. IGMP Interface Configuration



The IGMP Interface Configuration page contains the following fields:

- **Interface** — Select the interface for which data is to be displayed or configured from the drop-down menu.
- **Interface Mode** — Select Enable or Disable from the drop-down menu to set the administrative status of IGMP on the selected interface. The default is Disable.
- **Version** — Enter the version of IGMP you want to configure on the selected interface. Valid values are 1 to 3, and the default value is 3. This field is configurable only when IGMP interface mode is enabled.
- **Robustness** — Enter the robustness value. This variable allows tuning for the expected packet loss on a subnet. If you expect the subnet to be lossy, you should enter a higher number for this parameter. IGMP is robust to (robustness variable-1) packet losses. Valid values are from 1 to 255. The default value is 2.
- **Query Interval (secs)** — Enter the frequency in seconds at which IGMP host-query packets are to be transmitted on this interface. Valid values are from 1 to 3600. The default value is 125.
- **Query Max Response Time (1/10 of a second)** — Enter the maximum query response time to be advertised in IGMPv2 queries on this interface, in tenths of a second. The default value is 100. Valid values are from 0 to 255.
- **Startup Query Interval (secs)** — Enter the number of seconds between the transmission of startup queries on the selected interface. The valid values are from 1 to 300. The default value is 31.
- **Startup Query Count** — Enter the number of queries to be sent on startup. The valid values are from 1 to 20. The default value is 2.

- **Last Member Query Interval (1/10 of a second)** — Enter the last member query interval in tenths of a second. This is the maximum response time to be inserted into group-specific queries sent in response to leave group messages, and is also the amount of time between group-specific query messages. Valid values are from 0 to 255. The default value is 10. This value is not used for IGMP version 1.
- **Last Member Query Count** — Enter the number of queries to be sent on receiving a leave group report. Valid values are from 1 to 20. The default value is 2.

Configuring an IGMP Routing Interface

1. Open the **IGMP Interface Configuration** page.
2. Select the interface to configure from the **Interface** field.
3. Modify the remaining fields as needed.
4. Click **Apply Changes**.

The interface configuration is saved, and the device is updated.

Configuring an IGMP Routing Interface Using CLI Commands

For information about the CLI commands that perform this function, see the following chapter in the *CLI Reference Guide*:

- IGMP Commands

The following table summarizes the equivalent CLI commands for this feature.

Table 12-15. IGMP Interface Configuration Commands

CLI Command	Description
ip igmp last-member-query-count	Sets the number of Group-Specific Queries sent before the router assumes that there are no local members on the interface.
ip igmp last-member-query-interval	Configures the Maximum Response Time inserted in Group-Specific Queries which are sent in response to Leave Group messages.
ip igmp query-interval	Configures the query interval for the specified interface. The query interval determines how fast IGMP Host-Query packets are transmitted on this interface.
ip igmp query-max-response-time	Configures the maximum response time interval for the specified interface.
ip igmp robustness	Configures the robustness that allows tuning of the interface.
ip igmp startup-query-count	Sets the number of queries sent out on startup—at intervals equal to the startup query interval for the interface.
ip igmp startup-query-interval	Sets the interval between general queries sent at startup on the interface.
ip igmp version	Configures the version of IGMP for an interface.

IGMP Configuration Summary

Use the IGMP Configuration Summary page to display IGMP routing parameters and data. You must configure at least one IGMP router interface to access this page.

To display the page, click IPv4 Multicast → IGMP → Routing Interface → Configuration Summary in the tree view.

Figure 12-16. IGMP Configuration Summary

The screenshot shows the Dell OpenManage Switch Administrator interface. The breadcrumb navigation is IPv4 Multicast > IGMP > Routing Interface > Interface Summary. The page title is "Interface Summary" with "Print" and "Refresh" buttons. A dropdown menu shows "vlan111" selected. The "Interface Parameters" section contains the following data:

Interface Parameters	
Interface Mode	Disable
Operational Mode	Non-Operational
Version	V3
Query Interval	125 (1 to 3600 seconds)
Query Max Response Time	100 (0 to 255 1/10 th of a second)
Robustness	2
Startup Query Interval	31 (1 to 300 seconds)
Startup Query Count	2
Last Member Query Interval	10 (0 to 255 1/10 th of a second)
Last Member Query Count	2

The "Interface Statistics" section contains the following data:

Interface Statistics	
Querier	
Querier Status	
Querier Up Time	(hh:mm:ss)
Querier Expiry Time	(hh:mm:ss)
Wrong Version Queries Received	
Number of Joins Received	
Number of Groups	

The IGMP Configuration Summary page displays the following fields:

- **Interface** — Select the interface for which data is to be displayed.

Interface Parameters

- **Interface Mode** — The administrative status of IGMP on the selected interface.
- **IP Address** — The IP address of the selected interface.
- **Subnet Mask** — The subnet mask for the IP address of the selected interface.
- **Protocol State** — The operational state of IGMP on the selected interface.
- **Version** — The version of IGMP configured on the selected interface.

- **Query Interval (secs)** — The frequency at which IGMP host-query packets are transmitted on the selected interface.
- **Query Max Response Time (1/10 of a second)** — The maximum query response time advertised in IGMPv2 queries sent from the selected interface.
- **Robustness** — The robustness parameter for the selected interface. This variable allows tuning for the expected packet loss on a subnet. If a subnet is expected to be lossy, the robustness variable may be increased. IGMP is robust to (robustness variable-1) packet losses.
- **Startup Query Interval (secs)** — The interval at which startup queries are sent on the selected interface.
- **Startup Query Count** — The number of queries to be sent on startup.
- **Last Member Query Interval (1/10 of a second)** — The last member query interval is the maximum response time inserted into group-specific queries sent in response to leave group messages, and is also the amount of time between group-specific query messages. This value may be tuned to modify the leave latency of the network. A reduced value results in reduced time to detect the loss of the last member of a group. This value is not used for IGMP version 1.
- **Last Member Query Count** — The number of queries to be sent on receiving a leave group report.

Interface Statistics

- **Querier** — The address of the IGMP querier on the IP subnet to which the selected interface is attached.
- **Querier Status** — Indicates whether the selected interface is in querier or non querier mode.
- **Querier Up Time (secs)** — The time in seconds since the IGMP interface querier was last changed.
- **Querier Expiry Time (secs)** — The time in seconds remaining before the other querier present timer expires. If the local system is the querier, this is zero.
- **Wrong Version Queries** — The number of queries that have been received on the selected interface with an IGMP version that does not match the IGMP version configured for the interface, over the lifetime of the entry. IGMP requires that all routers on a LAN be configured to run the same version of IGMP. Therefore, a configuration error is indicated if any queries are received with the wrong version number.
- **Number of Joins** — The number of times a group membership has been added on the selected interface; that is, the number of times an entry for this interface has been added to the cache table. This gives an indication of the amount of IGMP activity on the interface.
- **Number of Groups** — The current number of entries for the selected interface in the cache table.

Displaying the IGMP Routing Configuration Using CLI Commands

For information about the CLI command that performs this function, see the following chapter in the *CLI Reference Guide*:

- IGMP Commands

The following table summarizes the equivalent CLI commands for this feature.

Table 12-16. IGMP Configuration Summary Command

CLI Command	Description
show ip igmp interface	Displays the IGMP information for the specified interface.

IGMP Cache Information

Use the **IGMP Cache Information** page to display cache parameters and data for an IP multicast group address. You must configure at least one IGMP router interface to access this page. Also, group membership reports must have been received on the selected interface for data to display here.

To display the page, click **IPv4 Multicast** → **IGMP** → **Routing Interface** → **Cache Information** in the tree view.

Figure 12-17. IGMP Cache Information

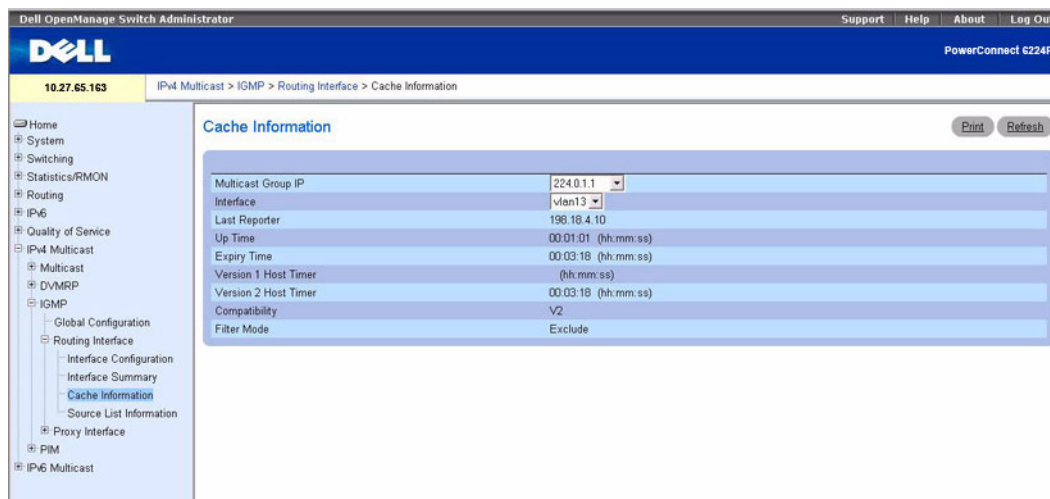

The **IGMP Cache Information** page displays the following fields:

- **Interface** — Select the interface for which data is to be displayed.
- **Multicast Group IP** — Select the IP multicast group address for which data is to be displayed. If no group membership reports have been received on the selected interface you cannot make this selection, and none of the data on this page displays.
- **Last Reporter** — The IP address of the source of the last membership report received for the IP Multicast group address on the selected interface.
- **Up Time** — The time elapsed since this entry was created.
- **Expiry Time** — The minimum amount of time remaining before this entry ages out.

- **Version 1 Host Timer** — The time remaining until the local router assumes that there are no longer any IGMP version 1 members on the IP subnet attached to this interface. When an IGMPv1 membership report is received, this timer is reset to the group membership timer. While this timer is non-zero, the local router ignores any IGMPv2 leave messages for this group that it receives on the selected interface. This field is displayed only if the interface is configured for IGMP version 1.
- **Version 2 Host Timer** — The time remaining until the local router assumes that there are no longer any IGMP version 2 members on the IP subnet attached to this interface. When an IGMPv2 membership report is received, this timer is reset to the group membership timer. While this timer is non-zero, the local router ignores any IGMPv1 and IGMPv3 leave messages for this group that it receives on the selected interface. This field is displayed only if the interface is configured for IGMP version 2.
- **Compatibility** — This parameter shows group compatibility mode (v1, v2 and v3) for this group on the specified interface.
- **Filter Mode** — The source filter mode (Include/Exclude/NA) for the specified group on this interface. When NA mode is active the field is blank.

Displaying Cache Information Using CLI Commands

For information about the CLI command that performs this function, see the following chapter in the *CLI Reference Guide*:

- IGMP Commands

The following table summarizes the equivalent CLI commands for this feature.

Table 12-17. IGMP Cache Information Command

CLI Command	Description
show ip igmp groups	Displays the registered multicast groups on the interface.

IGMP Interface

Use the **IGMP Interface** page to display detailed membership information for an interface. You must configure at least one IGMP router interface to access this page. Also, group membership reports must have been received on the selected interface for data to display here.

To display the page, click **IPv4 Multicast** → **IGMP** → **Routing Interface** → in the tree view.

Figure 12-18. IGMP Interface

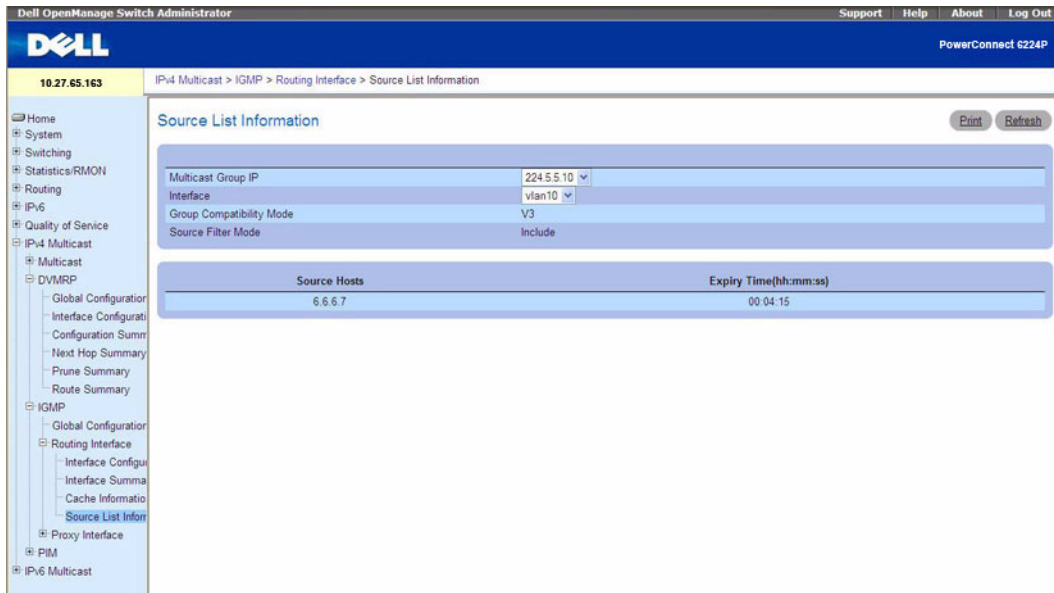

The **IGMP Interface** page displays the following fields:

- **Multicast Group IP** — Select the IP multicast group address for which data is to be displayed. If no group membership reports have been received on the selected interface, you cannot make this selection, and none of the remaining fields are displayed.
- **Interface** — The interface on which multicast packets are forwarded.
- **Group Compatibility Mode** — The group compatibility mode (v1, v2 and v3) for this group on the specified interface.
- **Source Filter Mode** — The source filter mode (Include/Exclude/NA) for the specified group on this interface.
- **Source Hosts** — The source addresses which are members of this multicast address.
- **Expiry Time** — The expiry time interval against each source address which are members of this multicast group. This is the amount of time after which the specified source entry is aged out.

Displaying IGMP Interface Detailed Membership

1. Open the **IGMP Interface Detailed Membership Info** page.
2. Select the interface to display from the **Interface** drop-down menu.
3. Select the desired **Multicast Group IP**.

Detailed membership information for this interface and multicast group IP displays.

Displaying IGMP Interface Detailed Membership Using CLI Commands

For information about the CLI command that performs this function, see the following chapter in the *CLI Reference Guide*:

- IGMP Commands

The following table summarizes the equivalent CLI commands for this feature.

Table 12-18. IGMP Interface Detailed Membership Command

CLI Command	Description
show ip igmp interface membership	Displays the list of interfaces that have registered in the multicast group.

Proxy Interface

The purpose of IGMP Proxy is to enable a multicast router to learn multicast group membership information and be able to forward multicast packets based upon the group membership information. The IGMP Proxy is capable of functioning only in certain topologies that do not require Multicast Routing Protocols (i.e. DVMRP, PIM-DM, and PIM-SM) and that have a tree-like topology, as there is no support for features like spanning tree to correct packet route loops.

The **Proxy Interface** menu page contains links to web pages that define and display Proxy Interface parameters and data. To display this page, click **IPv4 Multicast** → **IGMP** → **Proxy Interface** in the tree view. Following are the web pages accessible from this menu page:

- IGMP Proxy Interface Configuration
- IGMP Proxy Configuration Summary
- IGMP Proxy Interface Membership Info
- IGMP Proxy Interface Membership Info Detailed

IGMP Proxy Interface Configuration

The IGMP Proxy is used by IGMP Router (IPv4 system) to enable the system to issue IGMP host messages on behalf of hosts that the system discovered through standard IGMP router interfaces. Thus, this feature acts as proxy to all hosts residing on its router interfaces.

Use the **IGMP Proxy Interface Configuration** page to configure IGMP proxy for an interface. You must have configured at least one router interface before configuring or displaying data for an IGMP proxy interface, and it should not be an IGMP routing interface.

To display the page, click **IPv4 Multicast** → **IGMP** → **Proxy Interface** → **Interface Configuration** in the tree view.

Figure 12-19. IGMP Proxy Interface Configuration

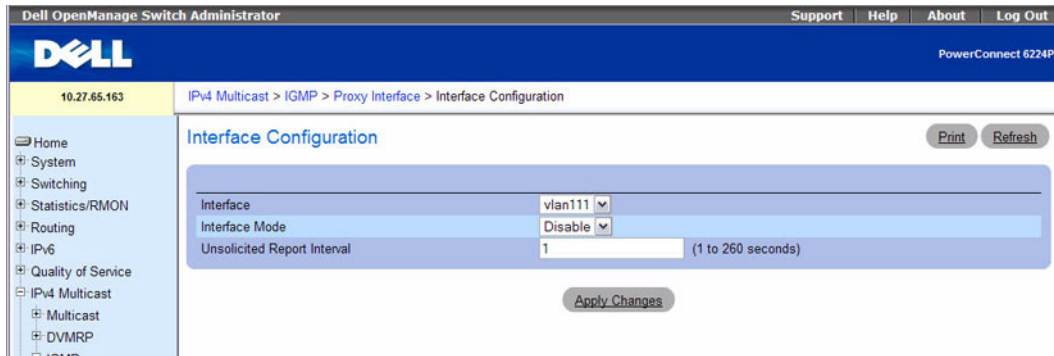

The **IGMP Proxy Interface Configuration** page contains the following fields:

- **Interface** — Select the port for which data is to be displayed or configured from the drop-down menu. You must have configured at least one router interface before configuring or displaying data for an IGMP Proxy interface and it should not be a IGMP routing interface. This field is configurable only when interface mode is disabled.
- **Interface Mode** — Select Enable or Disable from the drop-down menu to set the administrative status of IGMP Proxy on the selected interface. The default is Disable. Routing, IGMP, and Multicast global admin modes should be enabled to enable IGMP Proxy interface mode.
- **Unsolicited Report Interval** — Enter the unsolicited time interval value in seconds. The Unsolicited Report Interval is the time between repetitions of a host's initial report of membership in a group. Valid values are from 1 to 260. The default value is 1.

Configuring IGMP Proxy Interface

1. Open the **IGMP Proxy Interface Configuration** page.
2. Select the interface to display from the **Interface** drop-down menu.
3. Modify the remaining fields as needed.
4. Click **Apply Changes**.

The proxy interface configuration is saved, and the device is updated.

Configuring IGMP Proxy Interface Using CLI Commands

For information about the CLI commands that perform this function, see the following chapter in the *CLI Reference Guide*:

- IGMP Proxy Commands

The following table summarizes the equivalent CLI commands for this feature.

Table 12-19. IGMP Proxy Global Commands

CLI Command	Description
ip igmp-proxy	Enables the IGMP Proxy on the router.
ip igmp-proxy unsolicited-report-interval	Sets the unsolicited report interval for the IGMP Proxy router.

IGMP Proxy Configuration Summary

Use the **IGMP Proxy Configuration Summary** page to display proxy interface configurations by interface. You must have configured at least one router interface configured before data displays on this page.

To display the page, click **IPv4 Multicast** → **IGMP** → **Proxy Interface** → **Configuration Summary** in the tree view.

Figure 12-20. IGMP Proxy Configuration Summary

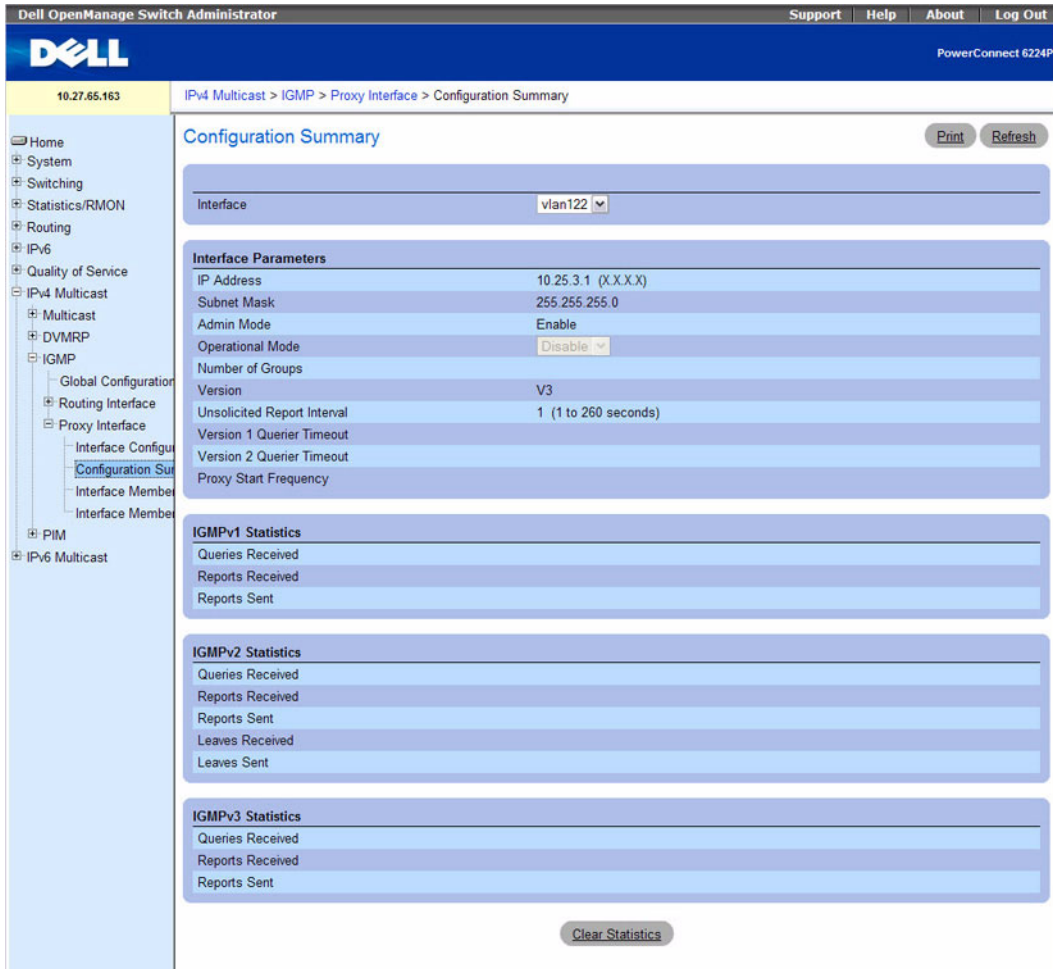

The IGMP Proxy Configuration Summary page displays the following fields:

- **Interface** — Displays the interface on which IGMP proxy is enabled. There can be only one IGMP Proxy interface.
- **IP Address** — The IP address of the IGMP Proxy interface.
- **Subnet Mask** — The subnet mask for the IP address of the IGMP Proxy interface.
- **Admin Mode** — The administrative status of IGMP Proxy on the selected interface.
- **Operational Mode** — The operational state of IGMP Proxy interface.

- **Number of Groups** — The current number of multicast group entries for the IGMP Proxy interface in the cache table.
- **Version** — The version of IGMP configured on the IGMP Proxy interface.
- **Unsolicited Report Interval** — The Unsolicited Report Interval is the time between repetitions of a host's initial report of membership in a group. Default: 1 second.
- **Version 1 Querier Timeout** — The older IGMP version 1 querier timeout value in seconds. The Older Version Querier Interval is the time-out for transitioning a host back to IGMPv3 mode once an older version query is heard. When an older version query is received, hosts set their Older Version Querier Present Timer to Older Version Querier Interval.
- **Version 2 Querier Timeout** — The older IGMP version 2 querier timeout value in seconds.
- **Proxy Start Frequency** — The number of times the proxy was brought up.
- **Proxy Interface Statistics** — The Queries Received, Reports Received/Sent, Leaves Received/Sent

Displaying IGMP Proxy Interface Configurations Using CLI Commands

For information about the CLI commands that perform this function, see the following chapter in the *CLI Reference Guide*:

- IGMP Proxy Commands

The following table summarizes the equivalent CLI commands for this feature.

Table 12-20. IGMP Proxy Interface Summary Commands

CLI Command	Description
show ip igmp-proxy	Displays a summary of the host interface status parameters.

IGMP Proxy Interface Membership Info

Use the **IGMP Proxy Interface Membership Info** page to display interface membership data for a specific IP multicast group address. You must have configured at least one router interface before you can display interface membership information, and it should not be an IGMP routing interface. Also, if no group membership reports have been received on the selected interface, no data displays on this page.

To display the page, click **IPv4 Multicast** → **IGMP** → **Proxy Interface** → **Interface Membership Info** in the tree view.

Figure 12-21. IGMP Proxy Interface Membership Info

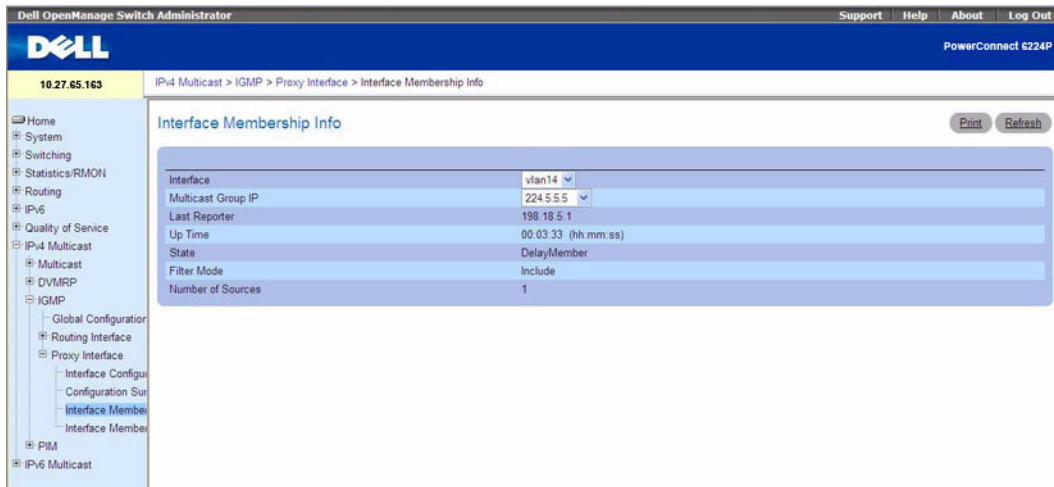

The **IGMP Proxy Interface Membership Info** page displays the following fields:

- **Interface** — Displays the interface on which IGMP proxy is enabled.
- **Multicast Group IP** — Select the IP multicast group address for which data is to be displayed. If no group membership reports have been received on the selected interface you cannot make this selection, and none of the following data displays.
- **Last Reporter** — The IP address of the source of the last membership report received for the IP Multicast group address on the IGMP Proxy interface.
- **Up Time (secs)** — The time elapsed since this entry was created.
- **State** — The state of the host entry. A Host can be in one of the state. Non-member state - does not belong to the group on the interface. Delaying member state - host belongs to the group on the interface and report timer running. The report timer is used to send out the reports. Idle member state - host belongs to the group on the interface and no report timer running.
- **Number of Sources** — The number of source hosts present in the selected multicast group.

Displaying IGMP Proxy Interface Membership Info Using CLI Commands

For information about the CLI command that performs this function, see the following chapter in the *CLI Reference Guide*:

- IGMP Proxy Commands

The following table summarizes the equivalent CLI commands for this feature.

Table 12-21. IGMP Proxy Interface Membership Command

CLI Command	Description
show ip igmp-proxy	Displays a summary of the host interface status parameters.
show ip igmp-proxy groups	Displays a table of information about multicast groups that IGMP Proxy reported.

IGMP Proxy Interface Membership Info Detailed

Use the **IGMP Proxy Interface Membership Info Detailed** page to display detailed interface membership data. You must have configured at least one router interface before you can display detailed interface membership information, and it should not be an IGMP routing interface. Also, if no group membership reports have been received on the selected interface you cannot display data.

To display the page, click **IPv4 Multicast** → **IGMP** → **Proxy Interface** → **Interface Membership Info Detailed** in the tree view.

Figure 12-22. IGMP Proxy Interface Membership Info Detailed

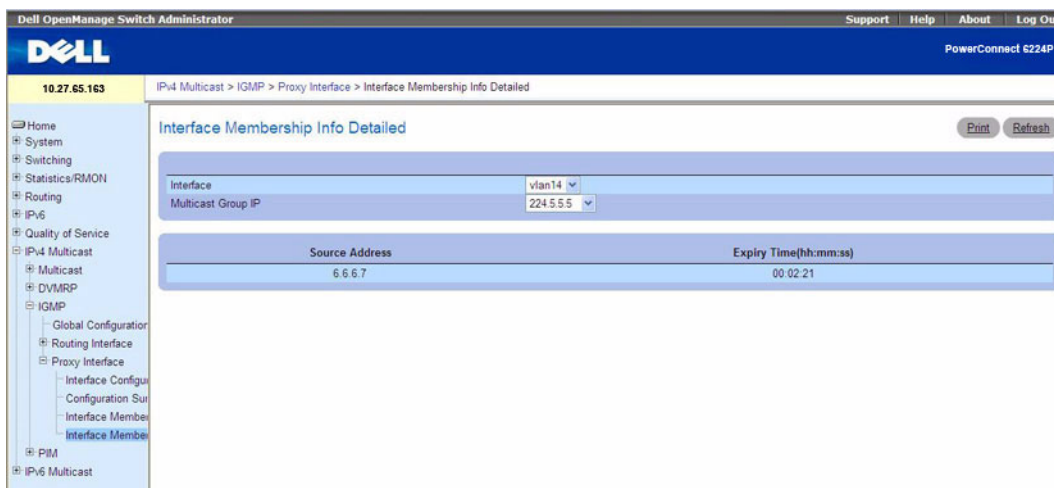

The **IGMP Proxy Interface Membership Info Detailed** page contains the following fields:

- **Interface** — Select the interface for which data is to be displayed.
- **Multicast Group IP** — Select the IP multicast group address for which data is to be displayed. If no group membership reports have been received on the selected interface, you are not able to make this selection, and none of the non-configurable data is displayed.
- **Source IP** — This parameter shows source addresses that are members of this multicast address.
- **Last Reporter** — The IP address of the source of the last membership report received for the selected interface's IP Multicast group address.

- **Up Time (secs)** — Displays the up time since the entry was created in the cache table.
- **State** — The state of the host entry. A host can be in one of the following states:
 - **Non-member State** — Does not belong to the group on the interface.
 - **Delaying Member State** — Host belongs to the group on the interface and report timer is running. The report timer is used to send out the reports.
 - **Idle Member State** — Host belongs to the group on the interface and no report timer is running.
- **Filter Mode** — The group filter mode (Include/Exclude/None) for the specified group on the IGMP Proxy interface.

Displaying Detailed IGMP Proxy Interface Membership Info

1. Open the **IGMP Proxy Interface Membership Info Detailed** page.
2. Select the interface to display from the **Interface** drop-down menu.
3. Select the desired **Multicast Group IP**.

Detailed membership data for this interface and multicast group IP displays.

Displaying Detailed IGMP Proxy Interface Membership Info Using CLI Commands

For information about the CLI command that performs this function, see the following chapter in the *CLI Reference Guide*:

- IGMP Proxy Commands

The following table summarizes the equivalent CLI commands for this feature.

Table 12-22. IGMP Proxy Interface Membership Detail Commands

CLI Command	Description
show ip igmp-proxy interface	Displays a detailed list of the host interface status parameters.
show ip igmp-proxy groups detail	Displays complete information about multicast groups that IGMP Proxy has reported.

Multicast Listener Discovery

Multicast Listener Discovery (MLD) protocol enables IPv6 routers to discover the presence of multicast listeners, the nodes who wish to receive the multicast data packets, on its directly-attached interfaces. The protocol specifically discovers which multicast addresses are of interest to its neighboring nodes and provides this information to the active multicast routing protocol that makes decisions on the flow of multicast data packets.

The Multicast router sends General Queries periodically to request multicast address listeners information from systems on an attached network. These queries are used to build and refresh the multicast address listener state on attached networks. Multicast listeners respond to these queries by reporting their multicast addresses listener state and their desired set of sources with Current-State Multicast address Records in the MLD2 Membership Reports. The Multicast router also processes unsolicited Filter-Mode-Change records and Source-List-Change Records from systems that want to indicate interest in receiving or not receiving traffic from particular sources.

The FASTPATH implementation of MLD v2 supports the multicast router portion of the protocol (i.e., not the listener portion). It is backward-compatible with MLD v1.

MLD Global Configuration

Use the **MLD Global Configuration** page to administratively enable and disable the MLD service.

To display the page, click **IPv6 Multicast** → **MLD** → **Global Configuration** in the tree view.

Figure 12-23. MLD Global Configuration

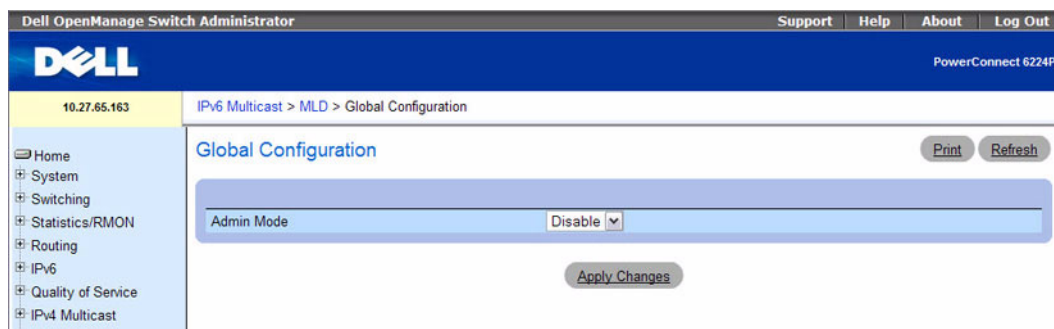

The **MLD Global Configuration** page contains the following field:

- **Admin Mode** — Select **Enable** or **Disable** to set the MLD administrative status. The default is **disable**. Click **Apply Changes** to send the updated configuration to the router. Configuration changes take effect immediately. These changes will not be retained across a power cycle unless a save is performed.

Configuring MLD Global Settings Using CLI Commands

For information about the CLI command that performs this function, see the following chapter in the *CLI Reference Guide*:

- IPv6 Routing Commands

The following table summarizes the equivalent CLI commands for this feature.

Table 12-23. IPv6 MLD Global Commands

CLI Command	Description
ipv6 mld router	Enables MLD in the router in global configuration mode and for a specific interface in interface configuration mode.

MLD Routing Interface Configuration

Use the **MLD Routing Interface Configuration** page to enable selected IPv6 router interfaces to discover the presence of multicast listeners, the nodes who wish to receive the multicast data packets, on its directly attached interfaces. To access this page, click **IPv6 Multicast** → **MLD** → **Routing Interface** → **Interface Configuration** in the navigation tree.

Figure 12-24. MLD Routing Interface Configuration



The **MLD Routing Interface Configuration** page contains the following fields:

- **Interface** — From the drop-down menu, select the VLAN routing interface to be configuration.
- **Interface Mode** — Select **Enable** or **Disable** to set the administrative status of MLD on the selected interface. The default is **Disable**.
- **Version** — Select the MLD version.

- **Query Interval** — Specify the number of seconds between MLD general queries. Valid values are 1 to 3600. The default value is 125.
- **Query Max Response Time (secs)** — Enter the maximum query response time to be advertised in MLDv2 queries on this interface, in ms. The default value is 10000. Valid values are 0 to 65535 milliseconds (ms).
- **Last Member Query Interval** — Enter the maximum response time inserted into group-specific queries sent in response to leave group messages. This value is also the amount of time between group-specific query messages. This value may be tuned to modify the leave latency of the network. Valid values are 0 to 65535 milliseconds (ms). The default is 1000.
- **Last Member Query Count** — The number of queries to be sent on receiving a leave group report. Valid values are 1 to 20. The default is 2.

Configuring MLD Routing Interfaces Using CLI Commands

For information about the CLI command that performs this function, see the following chapter in the *CLI Reference Guide*:

- IPv6 Routing Commands

The following table summarizes the equivalent CLI commands for this feature.

Table 12-24. IPv6 MLD Routing Interface Commands

CLI Command	Description
ipv6 mld last-member-query-count	Sets the number of listener-specific queries sent before the router assumes that there are no local members on the interface.
ipv6 mld last-member-query-interval	Sets the last member query interval for the MLD interface, which is the value of the maximum response time parameter in the groupspecific queries sent out of this interface.
ipv6 mld query-interval	Sets the MLD router's query interval for the interface.
ipv6 mld query-max-response-time	Sets MLD querier's maximum response time for the interface.
ipv6 mld router	Enables MLD in the router in global configuration mode and for a specific interface in interface configuration mode.

MLD Routing Interface Summary

Use the **MLD Routing Interface Summary** page to display information and statistics on a selected MLD-enabled interface. You must configure at least one IGMP router interface to access this page.

To access this page, click **IPv6 Multicast →MLD →Routing Interface →Interface Summary** in the navigation tree.

Figure 12-25. MLD Routing Interface Summary



The MLD Routing Interface Summary page contains the following fields:

- **Interface** — Select the VLAN for which data is to be displayed.

Interface Parameters

- **Global Admin Mode** — Displays whether MLD has been globally enabled or disabled.
- **Interface Mode** — Displays whether the administrative status of MLD on the selected interface is enabled or disabled.
- **Operational Mode** — Displays the operational state of MLD on the selected interface, regardless of the administrative setting.
- **Version** — Displays the version of MLD configured on the selected interface.
- **Query Interval** — Displays the interval in seconds at which MLD host-query packets are transmitted on the selected interface.
- **Query Max Response Time** — Displays the maximum query response time in milliseconds (ms) advertised in MLDv2 queries from the selected interface.

- **Robustness** — Displays the robustness parameter for the selected interface. This value allows tuning for the expected packet loss on a subnet. If a subnet is expected to be lossy, increase the robustness variable. MLD is robust to (robustness variable - 1) packet losses.
- **Startup Query Interval** — Displays the interval in seconds at which startup queries are sent on the selected interface.
- **Startup Query Count** — Displays the number of queries to be sent upon startup.
- **Last Member Query Interval** — Displays the maximum response time, in milliseconds, inserted into group-specific queries sent in response to leave group messages. This value is also the amount of time between group-specific query messages. This value may be tuned to modify the leave latency of the network. This value may be tuned to modify the leave latency of the network. A reduced value results in reduced time to detect the loss of the last member of a group.



NOTE: This value is not used for MLD version 1.

- **Last Member Query Count** — The number of queries to be sent on receiving a leave group report.

Interface Statistics

- **Querier Status** — Displays whether the selected router interface is currently the MLD querier. If another interface on the network has a lower source IP address, it becomes the querier.
- **Querier** — The address of the MLD querier on the IP subnet to which the selected interface is attached.
- **Querier Up Time** — The time in hours:minutes:seconds since the MLD interface querier was last changed.
- **Querier Expiry Time** — The time in hours:minutes:seconds remaining before the other querier present timer expires. If the local system is the querier, this will be zero.
- **Wrong Version Queries Received** — The number of queries that have been received on the selected interface with an MLD version that does not match the MLD version configured for the interface, over the lifetime of the entry. MLD requires that all routers on a LAN be configured to run the same version of MLD. Therefore, a configuration error is indicated if any queries are received with the wrong version number.
- **Number of Joins Received** — The number of times a group membership has been added on the selected interface; that is, the number of times an entry for this interface has been added to the cache table. This gives an indication of the amount of MLD activity on the interface.
- **Number of Groups** — The current number of entries for the selected interface in the cache table.

Click **Refresh** to display the latest information from the router.

Displaying IPv6 MLD Routing Interface Summary Information Using CLI Commands

For information about the CLI command that performs this function, see the following chapter in the *CLI Reference Guide*:

- IPv6 Routing Commands

The following table summarizes the equivalent CLI commands for this feature.

Table 12-25. IPv6 MLD Interface Summary Commands

CLI Command	Description
show ipv6 mld interface	Displays MLD related information for an interface.

MLD Routing Interface Cache Information

The **MLD Routing Interface Cache Information** page displays cache parameters and data for an IP multicast group address that has been reported to operational MLD routing interfaces. You must configure at least one MLD router interface to access this page. Also, group membership reports must have been received on the selected interface in order for data to be displayed here. To access this page, click **IPv6 Multicast** → **MLD** → **Routing Interface** → **Cache Information** in the navigation tree.

Figure 12-26. MLD Routing Interface Cache Information



The **MLD Routing Interface Cache Information** page contains the following fields:

- **Multicast Group IP** — Select the IP multicast group address for which data is to be displayed. Only if group membership reports have been received on the selected interface can you make this selection, and the data on this page displays.
- **Interface** — Select the MLD routing interface for which data is displayed.
- **Last Reporter** — The IP Address of the source of the last membership report received for this IP Multicast group address on the selected interface.
- **Up Time** — The time elapsed in hours:minutes:seconds since this entry was created.

- **Expiry Time** — The cache timer value which indicates the remaining lifetime in hours:minutes:seconds for each entry.
- **Version1 Host Timer** — The time in hours:minutes:seconds remaining until the local router assumes that there are no longer any MLD version 1 members on the IP subnet attached to this interface. When an MLDv1 membership report is received, this timer is reset to the group membership timer.
- **Compatibility** — The compatibility mode (V1, V2) for this multicast group on the specified interface.
- **Filter Mode** — The source filter mode for the specified multicast group on this interface. Possible values are **Include**, **Exclude** and **NA**. When **NA** mode is active, this field is blank.

Displaying IPv6 MLD Routing Cache Information Using CLI Commands

For information about the CLI command that performs this function, see the following chapter in the *CLI Reference Guide*:

- IPv6 Routing Commands

The following table summarizes the equivalent CLI commands for this feature.

Table 12-26. IPv6 MLD Routing Cache Information Command

CLI Command	Description
show ipv6 mld groups	Displays information about multicast groups that MLD reported.

MLD Routing Interface Source List Information

The **MLD Routing Interface Source List Information** page displays detailed membership information for an interface. You must configure at least one MLD router interface to access this page. Also, group membership reports must have been received on the selected interface in order for data to be displayed here. To access this page, click **IPv6 Multicast** → **MLD** → **Routing Interface** → **Source List Information** in the navigation tree.

Figure 12-27. MLD Routing Interface Source List Information



The MLD Routing Interface Source List Information page contains the following fields:

- **Multicast Group IP** — Select the IP multicast group address for which data is to be displayed. Only if group membership reports have been received on the selected interface can you make this selection, and the data on this page displays.
- **Interface** — Select the MLD routing interface for which data is displayed.
- **Group Compatibility Mode** — The compatibility mode (V1, V2) for this multicast group on the specified interface.
- **Source Filter Mode** — The source filter mode for the specified multicast group on this interface. Possible values are **Include**, **Exclude** and **NA**. When **NA** mode is active, this field is blank.
- **Source Hosts** — The source addresses which are members of this multicast address.
- **Expiry Time** — The expiry time interval in hours:minutes:seconds for each source address that is a member of this multicast group. This is the length of time after which the specified source entry is aged. out.

MLD Traffic

The MLD Traffic page displays summary statistics on the MLD messages sent to and from the router.

To access this page, click **IPv6 Multicast** → **MLD** → **Routing Interface** → **MLD Traffic** in the navigation tree.

Figure 12-28. MLD Traffic

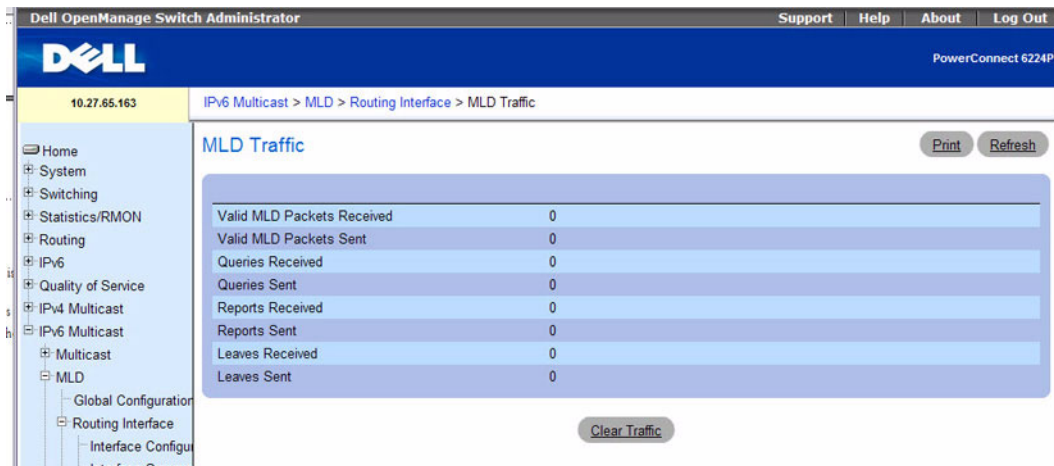

The MLD Traffic page contains the following fields:

- **Valid MLD Packets Received** — The total number of valid MLD packets received by the router.
- **Valid MLD Packets Sent** — The total number of valid MLD packets sent from the router
- **Querier Received** — The total number of MLD packets sent as the MLD querier.
- **Querier Sent** — The total number of MLD packets sent as the MLD querier.
- **Reports Received** — The total number of MLD reports received.
- **Reports Sent** — The total number of MLD reports received.
- **Leaves Received** — The total number of MLD Leave messages received.
- **Leaves Sent** — The total number of MLD Leave messages received.

Click **Refresh** to display the latest information from the router.

Click **Clear Traffic** to reset all counters to their default values.

Displaying IPv6 MLD Traffic Information Using CLI Commands

For information about the CLI command that performs this function, see the following chapter in the *CLI Reference Guide*:

- IPv6 Routing Commands

The following table summarizes the equivalent CLI commands for this feature.

Table 12-27. MLD Routing Traffic Command

CLI Command	Description
show ipv6 mld traffic	Displays MLD statistical information for the router.

MLD Proxy Configuration

When you configure an interface in MLD proxy mode, it acts as a proxy multicast host that sends MLD membership reports on one interface for MLD Membership reports received on all other MLD-enabled router interfaces.

Use the **MLD Proxy Interface Configuration** page to enable and disable ports as MLD proxy interfaces. To display this page, click **IPv6 Multicast** → **MLD** → **Proxy Interface** → **Interface Configuration** in the navigation tree.

Figure 12-29. MLD Proxy Interface Configuration

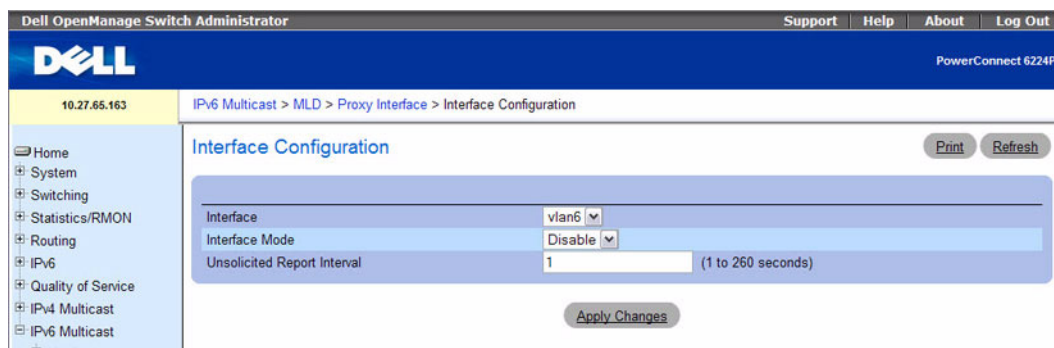

The **MLD Proxy Interface Configuration** page contains the following fields:

- **Interface** — Select the interface for which data is to be displayed or configured from the menu. You must have configured at least one router interface before configuring or displaying data for an MLD Proxy interface and it should not be a MLD routing interface.
- **Interface Mode** — Select enable or disable from the menu to set the administrative status of MLD Proxy on the selected interface. The default is disable. Routing, MLD and Multicast global admin modes should be enabled to enable MLD Proxy interface mode.
- **Unsolicited Report Interval** — Enter the unsolicited time interval value in seconds. The Unsolicited Report Interval is the time between repetitions of a host's initial report of membership in a group. Valid values are from (1 to 260). The default value is 1.

Click **Apply Changes** to send the updated configuration to the switch. Configuration changes take effect immediately. These changes will not be retained across a power cycle unless a save is performed.

Configuring MLD Proxy Global Settings Using CLI Commands

For information about the CLI command that performs this function, see the following chapter in the *CLI Reference Guide*:

- IPv6 Routing Commands

The following table summarizes the equivalent CLI commands for this feature.

Table 12-28. IPv6 MLD Proxy Global Commands

CLI Command	Description
ipv6 mld-proxy	Enables MLD Proxy on the router.
ipv6 mld-proxy reset-status	Resets the host interface status parameters of the MLD Proxy router.
ipv6 mld-proxy unsolicit-rprt-interval	Sets the unsolicited report interval for the MLD Proxy router.

MLD Proxy Configuration Summary

Use the **MLD Proxy Configuration Summary** page to view configuration and statistics on MLD proxy-enabled interfaces. To display this page, click **IPv6 Multicast** → **MLD** → **Proxy Interface** → **Configuration Summary** in the navigation tree.

Figure 12-30. MLD Proxy Configuration Summary

The screenshot displays the Dell OpenManage Switch Administrator interface. The breadcrumb navigation shows: IPv6 Multicast > MLD > Proxy Interface > Configuration Summary. The left navigation tree is expanded to 'Configuration Summary' under 'Proxy Interface'. The main content area is titled 'Configuration Summary' and includes the following sections:

- Interface:** A dropdown menu showing 'vlan6'.
- Interface Parameters:** A table of configuration settings:

IPv6 Address	
Prefix Length	
Admin Mode	Enable
Operational Mode	Disable
Number of Multicast Groups	
Version	V2
Unsolicited Report Interval	1 (1 to 260 seconds)
Version 1 Querier Timeout	(hh.mm.ss)
Proxy Start Frequency	
- MLDv1 Statistics:** A table of statistics:

Queries Received	
Reports Received	
Reports Sent	
Leaves Received	
Leaves Sent	
- MLDv2 Statistics:** A table of statistics:

Queries Received	
Reports Received	
Reports Sent	

Buttons for 'Print', 'Refresh', and 'Clear Statistics' are visible.

The MLD Proxy Configuration Summary page contains the following fields:

- **Interface** — Select the interface on which MLD proxy is enabled and for which data is to be displayed.
- **IPv6 Address** — The IPv6 address of the MLD Proxy interface.
- **Prefix Length** — Displays the prefix length for the IPv6 address of the MLD Proxy interface.
- **Admin Mode** — The administrative status of MLD Proxy on the selected interface.
- **Operational Mode** — The operational state of MLD Proxy interface.
- **Number of Multicast Groups** — The current number of multicast group entries for the MLD Proxy interface in the cache table.
- **Version** — The version of MLD configured on the MLD Proxy interface.
- **Unsolicited Report Interval** — The Unsolicited Report Interval in seconds is the time between repetitions of a host's initial report of membership in a group.
- **Version 1 Querier Timeout** — The older MLD version 1 querier timeout value in hours:minutes:seconds. The Older Version Querier Interval is the time-out for transitioning a host back to MLD mode once an older version query is heard. When an older version query is received, hosts set their Older Version Querier Present Timer to Older Version Querier Interval.
- **Proxy Start Frequency** — The number of times the proxy was brought up.

Click **Refresh** to refresh the data on the screen with the present state of the data in the router.

Click **Clear Statistics** to clear the MLD Proxy Interface statistics and reset the counters to their original values.

Displaying IPv6 MLD Proxy Summary Information Using CLI Commands

For information about the CLI command that performs this function, see the following chapter in the *CLI Reference Guide*:

- IPv6 Routing Commands

The following table summarizes the equivalent CLI commands for this feature.

Table 12-29. IPv6 MLD Proxy Summary Command

CLI Command	Description
show ipv6 mld-proxy	Displays a summary of the host interface status parameters.

Interface Membership Information

The **Interface Membership Information** page lists each IP multicast group for which the MLD proxy interface has received membership reports. To display this page, click **IPv6 Multicast** → **MLD** → **Proxy interface** → **Interface Membership Info** in the navigation tree.

Figure 12-31. Interface Membership Information

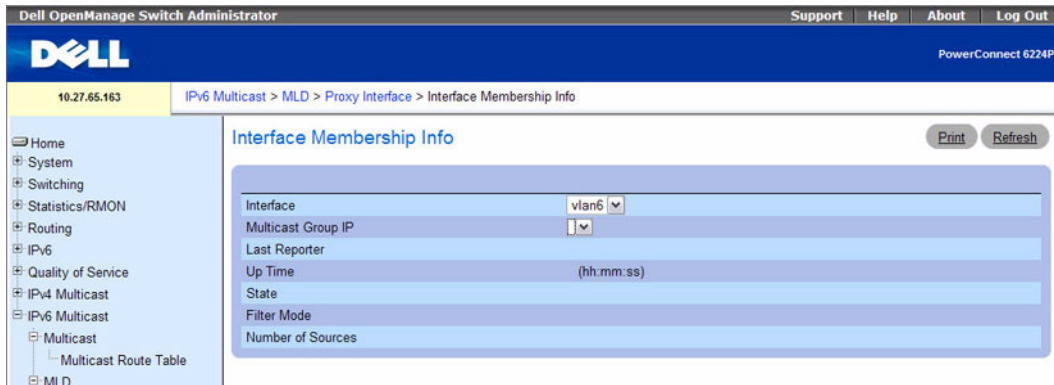

The **Interface Membership Information** page contains the following fields:

- **Interface** — Displays the interface on which MLD proxy is enabled.
- **Multicast Group IP** — Select the IP multicast group address for which data is to be displayed. If no group membership reports have been received on the selected interface you will not be able to make this selection, and none of the non-configurable data will be displayed.
- **Last Reporter** — The IP address of the source of the last membership report received for the IP Multicast group address on the MLD Proxy interface.
- **Uptime** — The time elapsed since this entry was created. Displayed in hours:minutes:seconds.
- **State** — The state of the host entry. A host can be in one of the following states:
 - **Non-member.** Does not belong to the group on the interface.
 - **Delaying Member.** Host belongs to the group on the interface and report timer is running. The report timer is used to send out the reports.
 - **Idle Member.** Host belongs to the group on the interface and no report timer is running.
- **Filter Mode** — The group filter mode for the specified group on the MLD Proxy interface. Possible values are **Include**, **Exclude**, or **None**.
- **Number of Sources** — The number of source hosts present in the selected multicast group.

Click **Refresh** to refresh the data on the screen with the present state of the data in the router.

Displaying IPv6 MLD Membership Information Using CLI Commands

For information about the CLI command that performs this function, see the following chapter in the *CLI Reference Guide*:

- IPv6 Routing Commands

The following table summarizes the equivalent CLI commands for this feature.

Table 12-30. IPv6 MLD Membership Information Command

CLI Command	Description
show ipv6 mld-proxy groups	Displays information about multicast groups that the MLD Proxy reported.

Interface Membership Information—Detailed

The **Interface Membership Information—Detailed** page provides additional information on the IP multicast groups for which the MLD proxy interface has received membership reports. To display this page, click **IPv6 Multicast** → **MLD** → **Proxy Interface** → **Interface Membership Info Detailed** in the navigation tree.

Figure 12-32. Interface Membership Information—Detailed

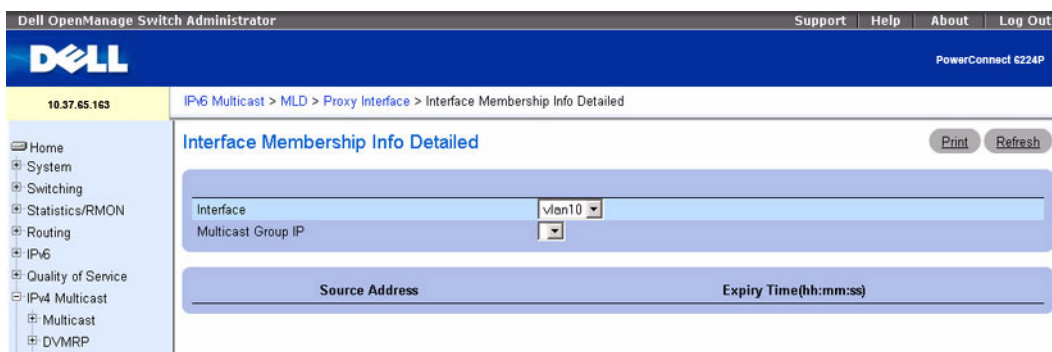

The **Interface Membership Information — Detailed** page contains the following fields:

- **Interface** — Select the interface on which MLD proxy is enabled for which data is to be displayed.
- **Multicast Group IP** — Select the IP multicast group address for which data is to be displayed. If no group membership reports have been received on the selected MLD Proxy interface you will not be able to make this selection, and none of the non-configurable data will be displayed.
- **Source Address** — This parameter shows source addresses which are members of this multicast address.
- **Expiry Time** — Displays the expiry time in hours:minutes:seconds since the entry was created in the cache table.
- Click **Refresh** to refresh the data on the screen with the present state of the data in the router.

Displaying IPv6 MLD Membership Detailed Information Using CLI Commands

For information about the CLI command that performs this function, see the following chapter in the *CLI Reference Guide*:

- IPv6 Routing Commands

The following table summarizes the equivalent CLI commands for this feature.

Table 12-31. IPv6 MLD Membership Detailed Information Command

CLI Command	Description
show ipv6 mld-proxy groups detail	Displays information about multicast groups that MLD Proxy reported.

Protocol Independent Multicast

Protocol Independent Multicast-Dense Mode (PIM-DM) protocol is a simple, protocol-independent multicast routing protocol. It uses an existing Unicast routing table and a Join/Prune/Graft mechanism to build a tree. PIM-DM creates source-based shortest-path distribution trees that make use of RPF. It cannot be used to build a shared distribution tree, as is the case in PIM-SM. PIM-DM assumes that when a sender starts sending data, all downstream routers and hosts want to receive a multicast datagram. PIM-DM initially floods multicast traffic throughout the network. Routers that do not have any downstream neighbors prune back the unwanted traffic. In addition to PRUNE messages, PIM-DM makes use of graft and assert messages. Graft messages are used whenever a new host wants to join the group. Assert messages are used to shutoff duplicate flows on the same multi-access network.

There are two versions of PIM-DM. Version 2 doesn't use the IGMP message; instead, it uses a message that is encapsulated in IP package, with protocol number 103. In Version 2, Hello message is introduced in place of query message.

PIM-DM is appropriate for:

- Densely distributed receivers
- Few senders -to- many receivers (due to frequent flooding)
- High volume of multicast traffic
- Constant stream of traffic

Protocol Independent Multicast-Sparse Mode (PIM-SM) is used to efficiently route multicast traffic to multicast groups that may span wide area networks and where bandwidth is a constraint. PIM-SM uses shared trees by default and implements source-based trees for efficiency. This data threshold rate is used to toggle between trees. PIM-SM assumes that no hosts want the multicast traffic unless they specifically ask for it. It creates a shared distribution tree centered on a defined rendezvous point (RP) from which source traffic is relayed to the receivers. Senders first send the multicast data to the RP, which in turn sends the data down the shared tree to the receivers. Shared trees centered on a RP do not necessarily provide the shortest/optimal path. In such cases, PIM-SM provides a means to switch to more efficient source-specific trees.

The **PIM** menu page contains links to web pages that define and display **PIM-DM** and **PIM-SM** parameters and data. Only one PIM protocol can be enabled on the switch at a time. To display the **PIM** page, click **IPv4 Multicast →PIM** or **IPv6 Multicast →PIM** in the tree view.

Following are the web pages accessible from this menu page:

- PIM Global Configuration
- PIM Global Status
- PIM Interface Configuration
- Interface Summary
- Candidate RP Configuration
- Static RP Configuration
- SSM Range Configuration
- BSR Candidate Configuration
- BSR Candidate Summary

PIM Global Configuration

Use the **PIM Global Configuration** page to configure the administrative status of PIM-DM or PIM-SM on the switch.

To display the page, click **IPv4 Multicast** → **PIM** → **Global Configuration** or **IPv6 Multicast** → **PIM** → **Global Configuration** in the navigation tree.

Figure 12-33. PIM Global Configuration

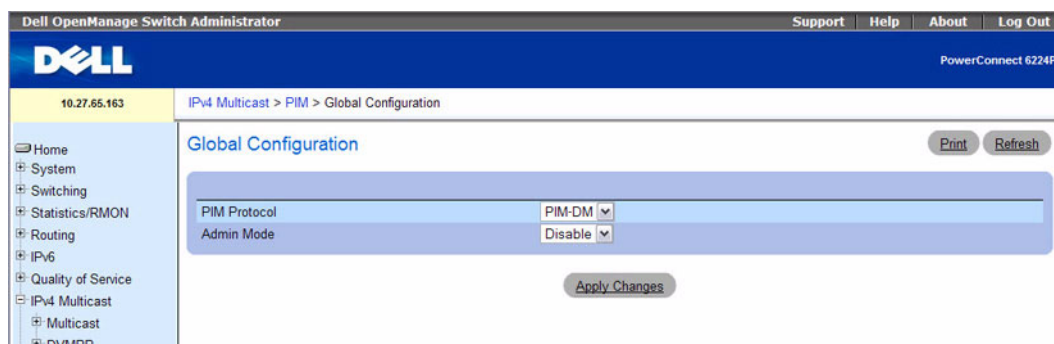

The **PIM Global Configuration** page contains the following fields:

- **PIM Protocol** — Select PIM-DM or PIM-SM. Only one PIM protocol can be enabled on the switch at a time. If you select PIM-SM, additional fields appear.
- **Admin Mode** — Select Enable or Disable from the drop-down menu to set the administrative status of PIM on the system. The default is Disable.
- **Data Threshold Rate** — If PIM-SM is selected as the protocol, enter the minimum source data rate in K bits/second above which the last-hop router switches to a source-specific shortest path tree. The valid values are from 0 to 2000 K bits/sec. The default value is 0. This field is not available for PIM-DM.

- **Register Threshold Rate** — If PIM-SM is selected as the protocol, enter the minimum source data rate in K bits/second above which the Rendezvous Point router switches to a source-specific shortest path tree. The valid values are from 0 to 2000 K bits/sec. The default value is 0. This field is not available for PIM-DM.

Configuring PIM Using CLI Commands

For information about the CLI command that performs this function, see the following chapters in the *CLI Reference Guide*:

- PIM-DM Commands
- PIM-SM Commands

The following table summarizes the equivalent CLI commands for this feature.

Table 12-32. PIM Global Configuration Commands

CLI Command	Description
ip pimdm	Enables the administrative mode of PIM-DM in the router.
ip pimsm	Enables the administrative mode of PIM-SM in the router.

PIM Global Status

Use the **PIM Global Status** page to view the administrative status of PIM-DM or PIM-SM on the switch.

To display the page, click **IPv4 Multicast** → **PIM** → **Global Status** or **IPv6 Multicast** → **PIM** → **Global Status** in the tree view.

Figure 12-34. PIM Global Status

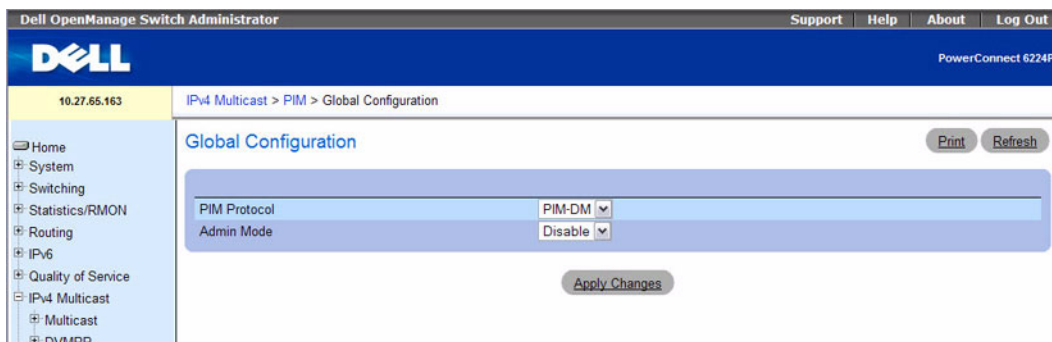

The **PIM Global Status** page contains the following fields:

- **PIM Protocol** — Select PIM-DM or PIM-SM. Only one PIM protocol can be enabled on the switch at a time. If you select PIM-SM, additional fields appear.

- **Admin Mode** — Displays the administrative status of the selected PIM protocol on the system.
- **Data Threshold Rate** — If PIM-SM is selected as the protocol, shows the minimum source data rate in Kbps above which the last-hop router switches to a source-specific shortest path tree.
- **Register Threshold Rate** — If PIM-SM is selected as the protocol, shows the minimum source data rate in Kbps above which the Rendezvous Point router switches to a source-specific shortest path tree.

Viewing Global PIM Settings Using CLI Commands

For information about the CLI command that performs this function, see the following chapter in the *CLI Reference Guide*:

- PIM-DM or PIM-SM Commands

The following table summarizes the equivalent CLI commands for this feature.

Table 12-33. PIM Global Settings Summary Commands

CLI Command	Description
show ip pimdm	Displays system-wide information for PIM-DM.
show ip pimsm	Displays the system-wide information for PIM-SM.

PIM Interface Configuration

Use the **PIM Interface Configuration** page to configure specific interfaces with PIM.

To display the page, click **IPv4 Multicast** → **PIM** → **Interface Configuration** or **IPv6 Multicast** → **PIM** → **Interface Configuration** in the tree view.

Figure 12-35. PIM Interface Configuration

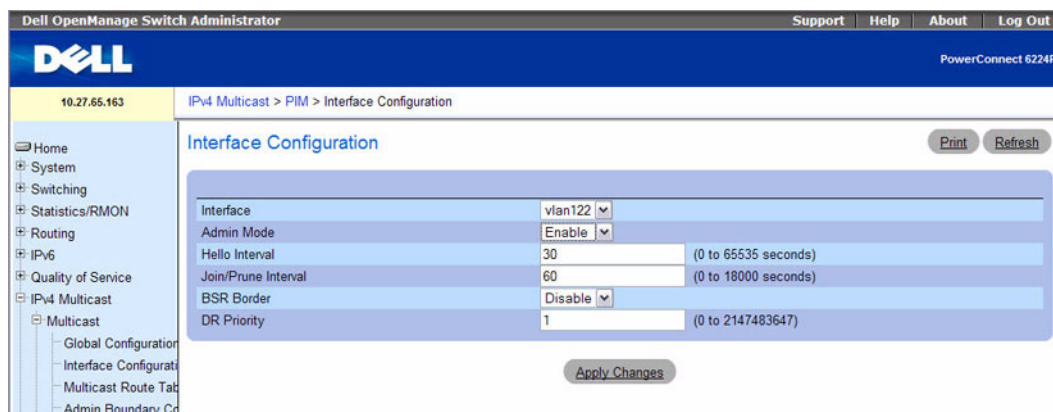

The **PIM Interface Configuration** page contains the following fields:

- **Interface** — Select the interface for which data is to be displayed or configured. You must have configured at least one router interface before configuring or displaying data for a PIM interface, otherwise an error message is displayed.
- **Admin Mode** — Select Enable or Disable from the drop-down menu to set the administrative status of PIM for the selected interface. The default is Disable.
- **Hello Interval** — Enter the number of seconds between PIM hello messages transmitted from the selected interface. The default value is 30. Valid values are 0 to 65535 seconds.
- **Join Prune Interval** — Enter the frequency at which PIM Join/Prune messages are transmitted on this PIM interface. The valid values are from (0 to 65535). The default value is 60.
- **BSR Border** — Indicates whether this interface is enabled or disables to act as a border for all PIM bootstrap messages. Bootstrap messages do not cross the BSR border.
- **DR Priority** — The Designated Router priority value. The router with the highest priority value is elected as the Designated Router. A shared-media such as Ethernet may have multiple PIM-SM routers connected to it. A single one of these routers, the DR, acts on behalf of directly connected hosts with respect to the PIM protocol. This field is applicable for PIM-SM only. The valid values are 0 to 2147483647.

Configuring PIM for an Interface

1. Open the **PIM Interface Configuration** page.
2. Select the interface to configure from the **Interface** field.
3. Modify the remaining fields as needed.
4. Click **Apply Changes**.

The interface configuration is saved, and the device is updated.

Configuring PIM for an Interface Using CLI Commands

For information about the CLI commands that perform this function, see the following chapter in the *CLI Reference Guide*:

- PIM-DM or PIM-SM Commands

The following table summarizes the equivalent CLI commands for this feature.

Table 12-34. PIM Interface Commands

CLI Command	Description
ip pimdm mode	Sets administrative mode of PIM-DM on an interface to enabled.
ip pimsm mode	Sets to enabled the administrative mode of PIM-SM multicast routing on a routing interface.

Interface Summary

Use the PIM Interface Summary page to display a PIM interface and its settings.

To display the page, click **IPv4 Multicast** → **PIM** → **Interface Summary** or **IPv6 Multicast** → **PIM** → **Interface Summary** in the tree view.

Figure 12-36. PIM Interface Summary

The screenshot shows the Dell OpenManage Switch Administrator web interface. The breadcrumb navigation is IPv4 Multicast > PIM > Interface Summary. The page title is "Interface Summary" with "Print" and "Refresh" buttons. A dropdown menu shows "Interface" set to "vlan111".

Interface Parameters

Admin Mode	Disable
Protocol State	Non-Operational
IP Address	9.25.67.1
Hello Interval	30 (0 to 65535 seconds)
Join/Prune Interval	60 (0 to 18000 seconds)
DR Priority	
BSR Border	
Designated Router	

Interface Neighbors

Neighbor IP	Up Time(hh:mm:ss)	Expiry Time(hh:mm:ss)
Neighbor Count		

The PIM Interface Summary page contains the following fields:

- **Interface** — Select the interface for which data is to be displayed. There must be configured at least one router interface before displaying data for a PIM interface, otherwise an error message displays.

Interface Parameters fields are:

- **Admin Mode** — Displays the administrative status of PIM for the selected interface.
- **Protocol State** — The operational state of the PIM protocol on this interface.
- **IP Address** — The IP address of the selected interface.
- **Hello Interval** — The frequency (in seconds) at which PIM hello messages are transmitted on the selected interface.
- **Join/Prune Interval** — The frequency (in seconds) at which PIM Join/Prune messages are transmitted on this PIM interface.
- **DR Priority** — Indicates the DR priority on the PIM interface. This field is supported in PIM-SM only.

- **BSR Border** — Specifies the BSR border mode on the PIM interface. This field is not supported for PIM-DM.
- **Designated Router** — The designated router on the selected PIM interface. For point-to-point interfaces, this is 0.0.0.0.

Interface Neighbors fields are:

- **Neighbor Count** — The number of PIM neighbors on the selected interface.
- **Neighbor IP** — The IP address of the PIM neighbor for which this entry contains information.
- **Up Time** (hh:mm:ss) — The time since this PIM neighbor (last) became a neighbor of the local router.
- **Expiry Time** (hh:mm:ss) — The minimum time remaining before this PIM neighbor is aged out.

Displaying PIM Interface Summary Using CLI Commands

For information about the CLI command that performs this function, see the following chapter in the *CLI Reference Guide*:

- PIM-DM or PIM-SM Commands

The following table summarizes the equivalent CLI commands for this feature.

Table 12-35. PIM Interface Summary Commands

CLI Command	Description
show ip pimdm interface	Displays interface information for PIM-DM on the specified interface.
show ip pimsm interface	Displays interface information for PIM-SM on the specified interface.

Candidate RP Configuration

The Candidate RP is configured on the Add Candidate RP page. Use the Candidate RP Configuration page to display and delete the configured rendezvous points (RPs) for each port using PIM.

To access the page, click **IPv4 Multicast** → **PIM** → **Candidate RP Configuration** or **IPv6 Multicast** → **PIM** → **Candidate RP Configuration**.

Figure 12-37. Candidate RP Configuration

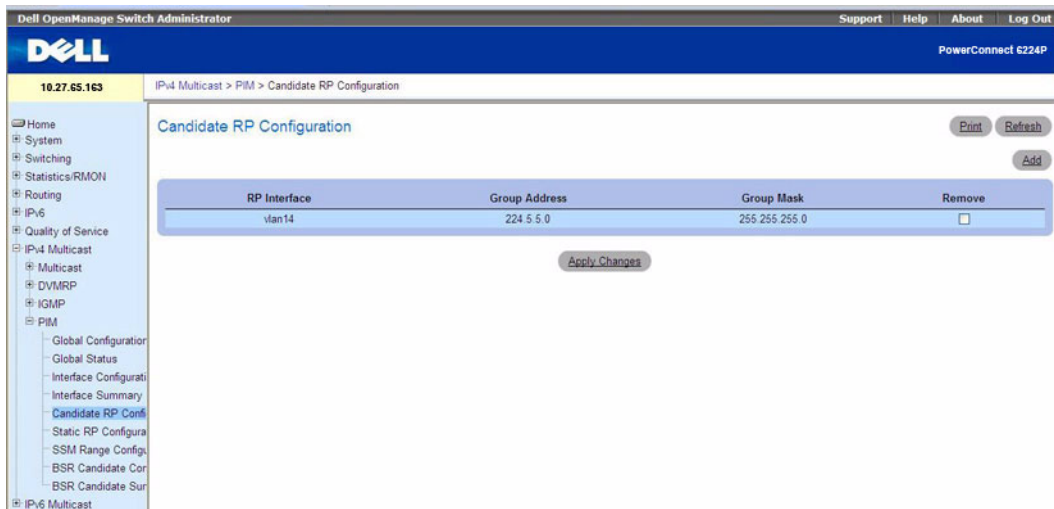

The Candidate RP Configuration page contains the following fields:

- **RP Interface** — Displays the interface for which the Candidate RP data is to be displayed. Slot 0 is the base unit.
- **Group Address** — Displays the group address transmitted in Candidate-RP-Advertisements.
- **Group Mask** — (IPv4) Displays the group address mask transmitted in Candidate-RP-Advertisements to fully identify the scope of the group which the router supports if it is elected as a Rendezvous Point.
- **Prefix Length** — (IPv6) Displays the group address prefix length transmitted in Candidate-RP-Advertisements to fully identify the scope of the group which the router will support if it is elected as a Rendezvous Point.
- **Remove** — Select this option and click **Apply Changes** to remove the specified Candidate RP Address for the PIM router.

After entering all required data, click **Apply Changes** to configure an interface as a PIM candidate.

Configuring the Candidate RP Using CLI Commands

For information about the CLI commands that perform this function, see the following chapter in the *CLI Reference Guide*:

- PIM Commands

The following table summarizes the equivalent CLI commands for this feature.

Table 12-36. PIM Candidate RP Configuration Commands

CLI Command	Description
ipv6 pimsm rp-candidate	Configures the router to advertise itself as a PIM candidate rendezvous point (RP) to the bootstrap router (BSR).

Adding a Candidate RP

Use the **Add Candidate RP** page to add PIM Candidate rendezvous points (RPs) for each IP multicast group.

1. Open the Candidate RP Configuration page.
2. Click Add.

The Add Candidate RP page displays.

Figure 12-38. Add Candidate RP

The screenshot shows a web-based configuration interface for adding a PIM Candidate RP. The page title is "Add Candidate RP" and it includes "Print" and "Refresh" buttons. The configuration form has three rows: "RP Interface" with a dropdown menu set to "vlan6", "Group Address" with a text input field containing "ff3e::7", and "Prefix Length" with a text input field containing "64". At the bottom of the form are "Apply Changes" and "Back" buttons.

3. Select the interface for which the Candidate RP is to be configured.
4. Enter the group address transmitted in Candidate-RP-Advertisements.
5. Enter the prefix length transmitted in Candidate-RP-Advertisements to fully identify the scope of the group which the router supports if elected as a Rendezvous Point.
6. Click **Apply Changes**.

The new Candidate RP is added, and the device is updated.

Static RP Configuration

Use the **PIM Static RP Configuration** page to display or remove the configured RP. The page also allows adding new static RPs by clicking the **Add** button.

To access the page, click **IPv4 Multicast** → **PIM** → **Static RP Configuration** or **IPv6 Multicast** → **PIM** → **Static RP Configuration**.

Figure 12-39. Static RP Configuration

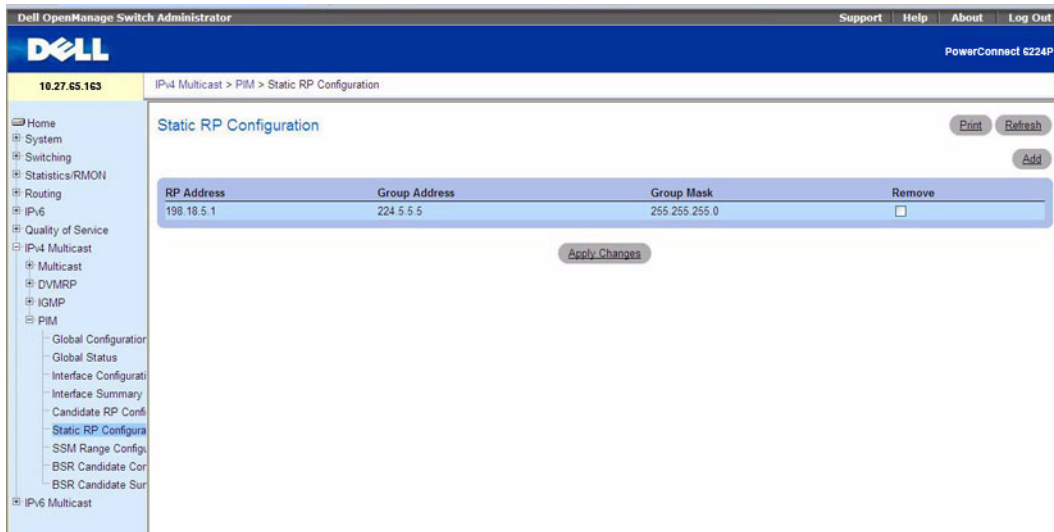

The **Static RP Configuration** page contains the following fields:

- **RP Address** — Select the slot and port for which data is to be displayed. Slot 0 is the base unit.
- **Group Address** — Specify the group address transmitted in Candidate-RP-Advertisements in Prefix/Length format.
- **Group Mask** — (IPv4) The Group Mask of the RP to be created or deleted.
- **Prefix Length** — (IPv6) Specify the group address prefix length transmitted in Candidate-RP-Advertisements to fully identify the scope of the group which the router will support if elected as a Rendezvous Point.
- **Remove** — Select this box to remove the specified static RP IP Address for the PIM router.

After entering all required data, click **Apply Changes** to configure an interface as a PIM candidate.

Adding a Static RP

Use the **Add Static RP** page to add the specified static rendezvous point (RP) for the PIM router.

1. Open the **Static RP Configuration** page.
2. Click **Add**.

The **Add Static RP** page displays.

Figure 12-40. Add Static RP

Add Static RP Print Refresh

RP Address	<input type="text"/>	(X.X.X.X)
Group Address	<input type="text"/>	(X.X.X.X)
Group Mask	<input type="text"/>	(X.X.X.X)
Override	<input type="checkbox"/>	

Apply Changes Back

3. Enter the IP address of the RP for the group range.
 4. Enter the group address of the RP.
 5. Enter the group mask of the RP.
 6. Check the **Override** option to configure the static RP to override the dynamic (candidate) RPs learned for same group ranges.
 7. Click **Apply Changes**.
- The new Static RP is added, and the device is updated.

Configuring the Candidate RP Using CLI Commands

For information about the CLI commands that perform this function, see the following chapter in the *CLI Reference Guide*:

- PIM Commands

The following table summarizes the equivalent CLI commands for this feature.

Table 12-37. PIM Candidate RP Configuration Commands

CLI Command	Description
ipv6 pimsm rp-address	Statically configures the RP address for one or more multicast groups.

SSM Range Configuration

Use this page to display or remove the the Source Specific Multicast (SSM) group IP address and group mask for the PIM router.

To display the page, click **IPv4 Multicast → PIM → SSM Range Configuration** or **IPv6 Multicast → PIM → SSM Candidate Configuration**.

Figure 12-41. SSM Range Configuration

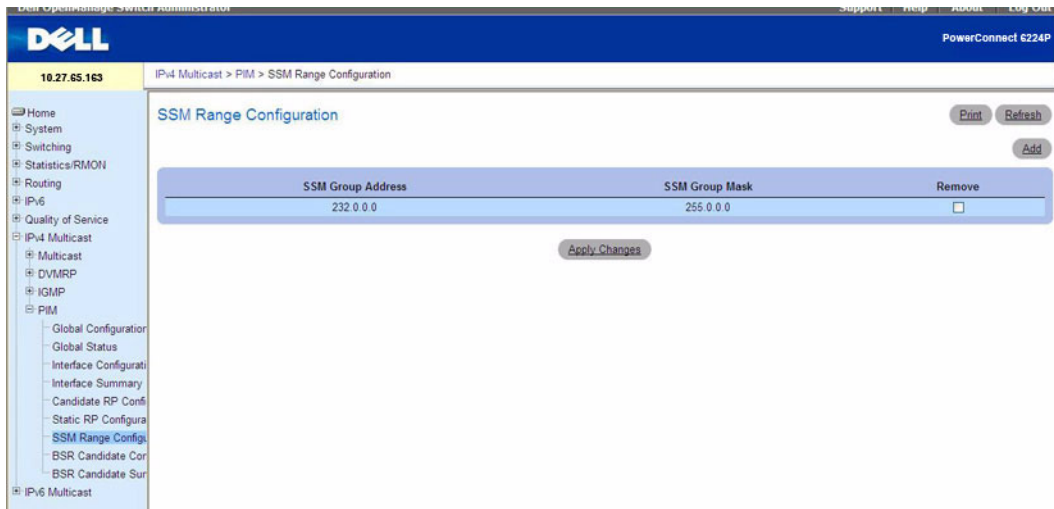

The SSM Range Configuration page contains the following fields:

- **SSM Group Address** — Displays the Source-Specific Multicast (SSM) group IP address.
- **SSM Group Mask** — (IPv4) Displays the SSM group ip-address mask.
- **SSM Prefix Length** — (IPv6) Displays the source-specific multicast group Prefix Length.
- **Remove** — Select this option and click **Apply Changes** to remove the specified SSM Group IP Addresses for the PIM router.

To configure the SSM Range, click the **Add** button to display the **SSM Range Configuration** page. Enter values for the **SSM Group Address** and **SSM Group Mask**, click **Apply Changes**, then the **Back** button.

Adding an SSM Range

Use the **Add SSM Range** page to add the Source-Specific Multicast (SSM) Group IP Address and Group Mask (IPv4) or Prefix Length (IPv6) for the PIM router.

1. Open the **SSM Range Configuration** page.
2. Click **Add**.

The **Add SSM Range** page displays.

Figure 12-42. Add SSM Range

The screenshot shows a web-based configuration interface for adding an SSM range. The title is "Add SSM Range" and there are "Print" and "Refresh" buttons in the top right. The main form area has a light blue background and contains three rows of configuration options:

- Add Default SSM Range:** A checkbox that is checked.
- SSM Group Address:** A text input field containing the value "FF3x:".
- SSM Prefix Length:** A text input field containing the value "32".

At the bottom of the form, there are two buttons: "Apply Changes" and "Back".

3. Click the Add Default SSM Range check box to add the default SSM Range. The default SSM Range is ff3x::/32.
4. Enter the SSM Group IP Address.
5. Enter the SSM Group Mask (IPv4) or SSM Prefix Length (IPv6).
6. Click **Apply Changes**.
The new SSM Range is added, and the device is updated.

Configuring the SSM Range Using CLI Commands

For information about the CLI commands that perform this function, see the following chapter in the *CLI Reference Guide*:

- PIM Commands

The following table summarizes the equivalent CLI commands for this feature.

Table 12-38. PIM SSM Range Configuration Command

CLI Command	Description
ipv6 pimsm ssm	Defines the Source Specific Multicast (SSM) range of multicast addresses.

BSR Candidate Configuration

Use this page to configure information to be used if the interface is selected as a bootstrap router.

To display the page, click **IPv4 Multicast** → **PIM** → **BSR Candidate Configuration** or **IPv6 Multicast** → **PIM** → **BSR Candidate Configuration**.

Figure 12-43. BSR Candidate Configuration

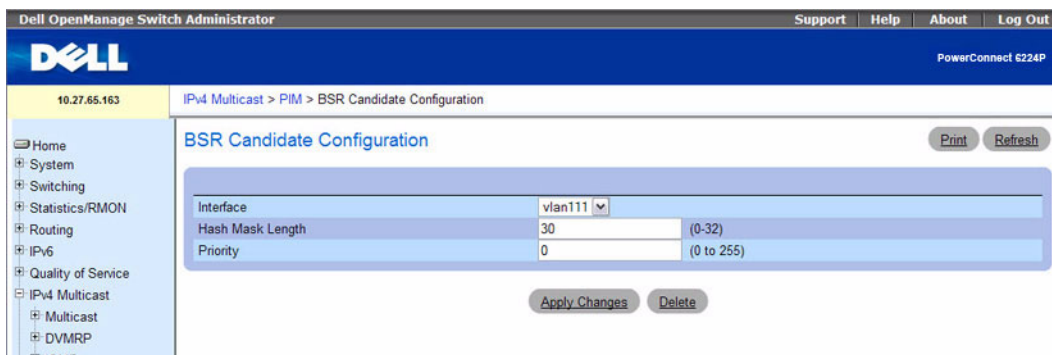

The **BSR Candidate Configuration** page contains the following fields:

- **Interface** — Select the interface for which data is to be displayed.
- **Hash Mask Length** — The CCSR hash mask length to be advertised in bootstrap messages if this interface is elected as the bootstrap router. This hash mask length will be used in the hash algorithm for selecting the RP for a particular group. The valid values are from 0 to 128. The default value is 126.
- **Priority** — The priority value for the local interface as a candidate bootstrap router. The valid values are from 0 to 255. The default value is 0.

Configuring the BSR Candidate Using CLI Commands

For information about the CLI commands that perform this function, see the following chapter in the *CLI Reference Guide*:

- PIM Commands

The following table summarizes the equivalent CLI commands for this feature.

Table 12-39. PIM BSR Candidate Configuration Commands

CLI Command	Description
ipv6 pimsm bsr-candidate	Configures the router to announce its candidacy as a bootstrap router (BSR).

BSR Candidate Summary

Use this page to display information about the configured BSR candidates. To display this page, click **IPv4 Multicast** → **PIM** → **BSR Candidate Summary** or **IPv6 Multicast** → **PIM** → **BSR Candidate Summary**.

Figure 12-44. BSR Candidate Summary

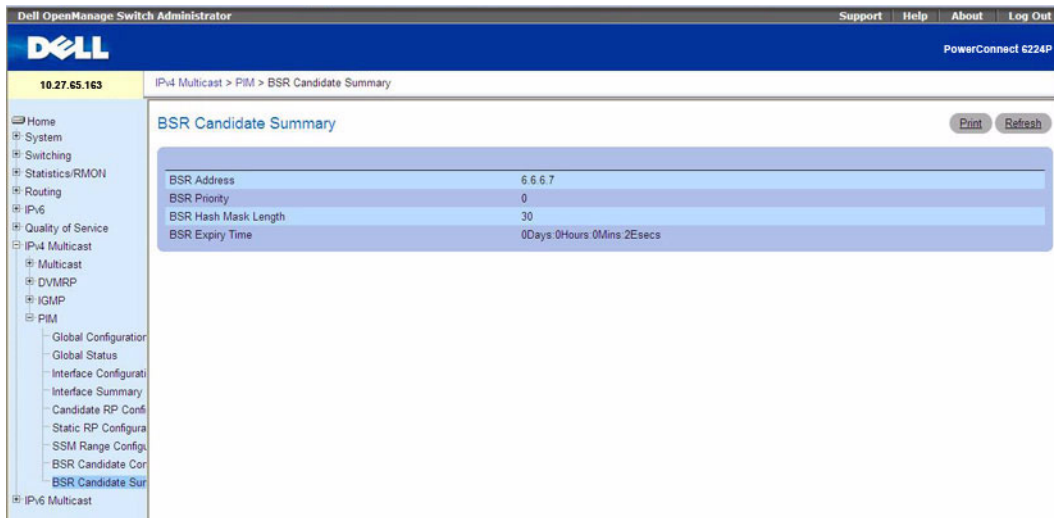

The **BSR Candidate Summary** page contains the following fields:

- **BSR Address** — Displays the IP address of the elected bootstrap router (BSR).
- **BSR Priority** — Displays the priority value of the elected BSR.
- **BSR Hash Mask Length** — Displays the mask length of the elected BSR.
- **BSR Expiry Time** — Time (in hours, minutes, and seconds) in which the learned elected Bootstrap Router (BSR) expires.

Viewing the BSR Candidate Summary Using CLI Commands

For information about the CLI commands that perform this function, see the following chapter in the *CLI Reference Guide*:

- PIM-DM or PIM-SM Commands

The following table summarizes the equivalent CLI commands for this feature.

Table 12-40. PIM BSR Candidate Configuration Commands

CLI Command	Description
show ipv6 pimsm bsr	Displays the bootstrap router (BSR) information.

Getting Help

This section contains information about getting help for questions about the PowerConnect 6200 Series switches. The topics covered in this section include:

- Obtaining Assistance
- Dell Enterprise Training and Certification
- Problems With Your Order
- Product Information
- Returning Items for Warranty Repair or Credit
- Before You Call
- Contacting Dell

Obtaining Assistance

If you experience a problem with your computer, you can complete the following steps to diagnose and troubleshoot the problem:

1. Fill out the "Diagnostics Checklist" on page 787.
2. Use Dell's extensive suite of online services available at Dell Support (support.dell.com) for help with installation and troubleshooting procedures. See "Online Services" on page 784 for a more extensive list of Dell Support online.
3. If the preceding steps have not resolved the problem, see "Contacting Dell" on page 788.

 **NOTE:** Call Dell Support from a telephone near or at the computer so that the support staff can assist you with any necessary procedures.

 **NOTE:** Dell's Express Service Code system may not be available in all countries.

When prompted by Dell's automated telephone system, enter your Express Service Code to route the call directly to the proper support personnel.

For instructions on using the Dell Support, see "Support Service" on page 785.

 **NOTE:** Some of the following services are not always available in all locations outside the continental U.S. Call your local Dell representative for information on availability.

Online Services

You can learn about Dell products and services on the following websites:

www.dell.com

www.dell.com/ap (Asian/Pacific countries only)

www.dell.com/jp (Japan only)

www.euro.dell.com (Europe only)

www.dell.com/la (Latin American and Caribbean countries)

www.dell.ca (Canada only)

You can access Dell Support through the following websites and e-mail addresses:

- Dell Support websites
support.dell.com
support.jp.dell.com (Japan only)
support.euro.dell.com (Europe only)

- Dell Support e-mail addresses
mobile_support@us.dell.com
support@us.dell.com
la-techsupport@dell.com (Latin America and Caribbean countries only)
apsupport@dell.com (Asian/Pacific countries only)
- Dell Marketing and Sales e-mail addresses
apmarketing@dell.com (Asian/Pacific countries only)
sales_canada@dell.com (Canada only)
- Anonymous file transfer protocol (FTP)
ftp.dell.com

Log in as user: anonymous, and use your e-mail address as your password.

Automated Order-Status Service

To check on the status of any Dell products that you have ordered, you can go to support.dell.com, or you can call the automated order-status service. A recording prompts you for the information needed to locate and report on your order. For the telephone number to call for your region, see "Contacting Dell" on page 788.

Support Service

Dell's support service is available 24 hours a day, 7 days a week, to answer your questions about Dell hardware. Our support staff use computer-based diagnostics to provide fast, accurate answers.

To contact Dell's support service, see "Before You Call" on page 786 and then see the contact information for your region.

Dell Enterprise Training and Certification

Dell Enterprise Training and Certification is available; see www.dell.com/training for more information. This service may not be offered in all locations.

Problems With Your Order

If you have a problem with your order, such as missing parts, wrong parts, or incorrect billing, contact Dell for customer assistance. Have your invoice or packing slip handy when you call. For the telephone number to call for your region, see "Contacting Dell" on page 788.

Product Information

If you need information about additional products available from Dell, or if you would like to place an order, visit the Dell website at www.dell.com. For the telephone number to call for your region or to speak to a sales specialist, see "Contacting Dell" on page 788.

Returning Items for Warranty Repair or Credit

Prepare all items being returned, whether for repair or credit, as follows:

1. Call Dell to obtain a Return Material Authorization Number, and write it clearly and prominently on the outside of the box.
For the telephone number to call for your region, see "Contacting Dell" on page 788.
2. Include a copy of the invoice and a letter describing the reason for the return.
3. Include a copy of the Diagnostics Checklist (see "Diagnostics Checklist" on page 787), indicating the tests that you have run and any error messages reported by the Dell Diagnostics.
4. Include any accessories that belong with the item(s) being returned (such as power cables, media such as CDs and diskettes, and guides) if the return is for credit.
5. Pack the equipment to be returned in the original (or equivalent) packing materials.

You are responsible for paying shipping expenses. You are also responsible for insuring any product returned, and you assume the risk of loss during shipment to Dell. Collect On Delivery (C.O.D.) packages are not accepted.

Returns that are missing any of the preceding requirements will be refused at Dell's receiving dock and returned to you.

Before You Call



NOTE: Have your Express Service Code ready when you call. The code helps Dell's automated-support telephone system direct your call more efficiently.

Remember to fill out the Diagnostics Checklist (see "Diagnostics Checklist" on page 787). If possible, turn on your computer before you call Dell for assistance and call from a telephone at or near the computer. You may be asked to type some commands at the keyboard, relay detailed information during operations, or try other troubleshooting steps possible only at the computer itself. Ensure that the computer documentation is available.



WARNING: Before working inside your switch, follow the safety instructions in the Safety, Environmental, and Regulatory Information that shipped with your system.

Diagnostics Checklist

Name:

Date:

Address:

Phone number:

Service Tag (bar code on the back or bottom of the computer):

Express Service Code:

Return Material Authorization Number (if provided by Dell support technician):

Operating system and version:

Devices:

Expansion cards:

Are you connected to a network? Yes No

Network, version, and network adapter:

Programs and versions:

See your operating system documentation to determine the contents of the system's start-up files. If the computer is connected to a printer, print each file. Otherwise, record the contents of each file before calling Dell.

Error message, beep code, or diagnostic code:

Description of problem and troubleshooting procedures you performed:

Contacting Dell

For customers in the United States, call 800-WWW.DELL (800.999.3355).



NOTE: If you do not have an active Internet connection, you can find contact information on your purchase invoice, packing slip, bill, or Dell product catalog.

Dell provides several online and telephone-based support and service options. Availability varies by country and product, and some services may not be available in your area. To contact Dell for sales, technical support, or customer service issues:

1. Visit support.dell.com.
2. Click your country/region at the bottom of the page. For a full listing of country/region click **All**.
3. Click **All Support** from Support menu.
4. Select the appropriate service or support link based on your need.
5. Choose the method of contacting Dell that is convenient for you.