

Alienware M17x R4

Owner's Manual

Computer model: M17x R4
Regulatory model: P11E
Regulatory type: P11E002



Notes, Cautions, and Warnings



NOTE: A NOTE indicates important information that helps you make better use of your computer.



CAUTION: A CAUTION indicates potential damage to hardware or loss of data if instructions are not followed.



WARNING: A WARNING indicates a potential for property damage, personal injury, or death.

Information in this document is subject to change without notice.

© 2012 Dell Inc. All rights reserved.

Reproduction of these materials in any manner whatsoever without the written permission of Dell Inc. is strictly forbidden.

Trademarks used in this text: Dell™ and the DELL logo are trademarks of Dell Inc.; Alienware® is a registered trademark of Alienware Corporation; Bluetooth® is a registered trademark owned by Bluetooth SIG, Inc. and is used by Dell under license; Microsoft®, Windows®, and the Windows start button logo  are either trademarks or registered trademarks of Microsoft Corporation in the United States and/or other countries.

Other trademarks and trade names may be used in this document to refer to either the entities claiming the marks and names or their products. Dell Inc. disclaims any proprietary interest in trademarks and trade names other than its own.

Contents

1	Before You Begin	9
	Turn Off Your Computer and Connected Devices.	9
	Safety Instructions	9
	Recommended Tools.	10
2	After Working Inside Your Computer	11
3	Removing the Battery Pack	12
	Procedure	12
4	Replacing the Battery Pack	13
	Procedure	13
	Postrequisites	13
5	Removing the Compartment Door	14
	Prerequisites	14
	Procedure	14
6	Replacing the Compartment Door	15
	Procedure	15
	Postrequisites	15
7	Removing the Coin-Cell Battery	16
	Prerequisites	16
	Procedure	16
8	Replacing the Coin-Cell Battery	17
	Procedure	17
	Postrequisites	17
9	Removing the Hard Drive(s)	18
	Prerequisites	18
	Procedure	18

10	Replacing the Hard Drive(s)	21
	Procedure	21
	Postrequisites	21
11	Removing the Memory Module(s)	22
	Prerequisites	22
	Procedure	22
12	Replacing the Memory Module(s)	24
	Procedure	24
	Postrequisites	25
13	Removing the Graphics-Card Heat Sink Fan	26
	Prerequisites	26
	Procedure	27
14	Replacing the Graphics-Card Heat Sink Fan	28
	Procedure	28
	Postrequisites	28
15	Removing the Processor Heat-Sink Fan	29
	Prerequisites	29
	Procedure	30
16	Replacing the Processor Heat-Sink Fan	31
	Procedure	31
	Postrequisites	31
17	Removing the Graphics-Card Assembly	32
	Prerequisites	32
	Procedure	33

18	Replacing the Graphics-Card Assembly	34
	Procedure	34
	Postrequisites	34
19	Removing the Processor Heat-Sink	35
	Prerequisites	35
	Procedure	36
20	Replacing the Processor Heat-Sink	37
	Procedure	37
	Postrequisites	37
21	Removing the Processor Module	38
	Prerequisites	38
	Procedure	38
22	Replacing the Processor Module	40
	Procedure	40
	Postrequisites	40
23	Removing the Center Control Cover	41
	Prerequisites	41
	Procedure	41
24	Replacing the Center Control Cover	44
	Procedure	44
	Postrequisites	44
25	Removing the Keyboard	45
	Prerequisites	45
	Procedure	45

26	Replacing the Keyboard	48
	Procedure	48
	Postrequisites	48
27	Removing the Mini-Card	49
	Prerequisites	49
	Procedure	50
28	Replacing the Mini-Card	51
	Procedure	51
	Postrequisites	52
29	Removing the WirelessHD Card	53
	Prerequisites	53
	Procedure	53
30	Replacing the WirelessHD Card	54
	Procedure	54
	Postrequisites	54
31	Removing the Power Button Board	55
	Prerequisites	55
	Procedure	55
32	Replacing the Power Button Board	56
	Procedure	56
	Postrequisites	56
33	Removing the Display Assembly	57
	Prerequisites	57
	Procedure	57

34	Replacing the Display Assembly	60
	Procedure	60
	Postrequisites	60
35	Removing the Status Light Board	61
	Prerequisites	61
	Procedure	61
36	Replacing the Status Light Board	63
	Procedure	63
	Postrequisites	63
37	Removing the Palm Rest Assembly	64
	Prerequisites	64
	Procedure	65
38	Replacing the Palm Rest Assembly	66
	Procedure	66
	Postrequisites	66
39	Removing the Bluetooth Card	67
	Prerequisites	67
	Procedure	67
40	Replacing the Bluetooth Card	69
	Procedure	69
	Postrequisites	69
41	Removing the Speakers	70
	Prerequisites	70
	Procedure	70
42	Replacing the Speakers	72
	Procedure	72

Postrequisites	72
43 Removing the Optical Drive	73
Prerequisites	73
Procedure.	73
44 Replacing the Optical Drive	76
Procedure.	76
Postrequisites	76
45 Removing the System Board.	77
Prerequisites	77
Procedure.	78
46 Replacing the System Board.	79
Procedure.	79
Postrequisites	79
Entering the Service Tag in the BIOS	80
47 System Setup	81
Configuring the System Setup	81
Entering System Setup	81
System Setup Screens.	81
System Setup Options.	82
48 Flashing the BIOS	88

Turn Off Your Computer and Connected Devices

 **CAUTION:** To avoid losing data, save and close all open files and exit all open programs before you turn off your computer.

- 1 Save and close all open files and exit all open programs.
- 2 Click **Start**  and click **Shut down**.

Microsoft Windows shuts down and then the computer turns off.

 **NOTE:** If you are using a different operating system, see the documentation of your operating system for shut-down instructions.

- 3 Disconnect your computer and all attached devices from their electrical outlets.
- 4 Disconnect all telephone cables, network cables, and attached devices from your computer.
- 5 Press and hold the power button for about 5 seconds, after the computer is unplugged, to ground the system board.

Safety Instructions

Use the following safety guidelines to protect your computer from potential damage and ensure your personal safety.

 **WARNING:** Before working inside your computer, read the safety information that shipped with your computer. For additional safety best practices information, see the Regulatory Compliance Homepage at dell.com/regulatory_compliance.

 **WARNING:** Disconnect all power sources before opening the computer cover or panels. After you finish working inside the computer, replace all covers, panels, and screws before connecting to the power source.

 **CAUTION:** To avoid damaging the computer, ensure that the work surface is flat and clean.

 **CAUTION:** To avoid damaging the components and cards, handle them by their edges and avoid touching pins and contacts.

- △ **CAUTION:** Only a certified service technician is authorized to remove the computer cover and access any of the components inside the computer. See the safety instructions for complete information about safety precautions, working inside your computer, and protecting against electrostatic discharge.
- △ **CAUTION:** Before touching anything inside your computer, ground yourself by touching an unpainted metal surface, such as the metal at the back of the computer. While you work, periodically touch an unpainted metal surface to dissipate static electricity, which could harm internal components.
- △ **CAUTION:** When you disconnect a cable, pull on its connector or on its pull-tab, not on the cable itself. Some cables have connectors with locking tabs or thumb-screws that you must disengage before disconnecting the cable. When disconnecting cables, keep them evenly aligned to avoid bending any connector pins. When connecting cables, ensure that the connectors and ports are correctly oriented and aligned.
- △ **CAUTION:** To disconnect a network cable, first unplug the cable from your computer and then unplug the cable from the network device.
- △ **CAUTION:** Press and eject any installed card from the 8-in-1 Media Card Reader.

Recommended Tools

The procedures in this document may require the following tools:

- Phillips screwdriver
- Plastic scribe
- Small flat-blade screwdriver

2

After Working Inside Your Computer

After you complete replacement procedures, ensure the following:

- Replace all screws and ensure that no stray screws remain inside your computer
- Connect any external devices, cables, cards, and any other part(s) you removed before working on your computer
- Connect your computer and all attached devices to their electrical outlets



CAUTION: Before turning on your computer, replace all screws and ensure that no stray screws remain inside the computer. Failure to do so may damage your computer.

3

Removing the Battery Pack

⚠ WARNING: Before working inside your computer, read the safety information that shipped with your computer and follow the steps in "Before You Begin" on page 9. For additional safety best practices information, see the Regulatory Compliance Homepage at dell.com/regulatory_compliance.

Procedure

- 1 Slide the battery latch to the unlock position as shown. The battery pack pops up.
- 2 Remove the battery pack.



1 battery pack

2 battery latch

4

Replacing the Battery Pack

 **WARNING:** Before working inside your computer, read the safety information that shipped with your computer and follow the steps in "Before You Begin" on page 9. For additional safety best practices information, see the Regulatory Compliance Homepage at dell.com/regulatory_compliance.

Procedure

 **CAUTION:** To avoid damage to the computer, use only the battery designed for this particular Alienware computer.

Align the tabs on the battery with the slots on the battery bay and snap the battery into place.

Postrequisites

Follow the instructions in "After Working Inside Your Computer" on page 11.

5

Removing the Compartment Door

⚠ WARNING: Before working inside your computer, read the safety information that shipped with your computer and follow the steps in "Before You Begin" on page 9. For additional safety best practices information, see the Regulatory Compliance Homepage at dell.com/regulatory_compliance.

Prerequisites

Remove the battery pack. See "Removing the Battery Pack" on page 12.

Procedure

- 1 Remove the screws that secure the compartment door to the computer base.
- 2 Slide and lift the compartment door away from the computer.



1 compartment door

2 screws (2)

6

Replacing the Compartment Door

 **WARNING:** Before working inside your computer, read the safety information that shipped with your computer and follow the steps in "Before You Begin" on page 9. For additional safety best practices information, see the Regulatory Compliance Homepage at dell.com/regulatory_compliance.

Procedure

- 1 Align the tabs on the compartment door with the slots on the computer base and slide the compartment door into place.
- 2 Replace the two screws that secure the compartment door to the computer base.

Postrequisites

- 1 Replace the battery pack. See "Replacing the Battery Pack" on page 13.
- 2 Follow the instructions in "After Working Inside Your Computer" on page 11.

7

Removing the Coin-Cell Battery

⚠ WARNING: Before working inside your computer, read the safety information that shipped with your computer and follow the steps in "Before You Begin" on page 9. For additional safety best practices information, see the Regulatory Compliance Homepage at dell.com/regulatory_compliance.

Prerequisites

- 1 Remove the battery pack. See "Removing the Battery Pack" on page 12.
- 2 Remove the compartment door. See "Removing the Compartment Door" on page 14.

Procedure

Use a plastic scribe to pry up the coin-cell battery from the slot on the system board.

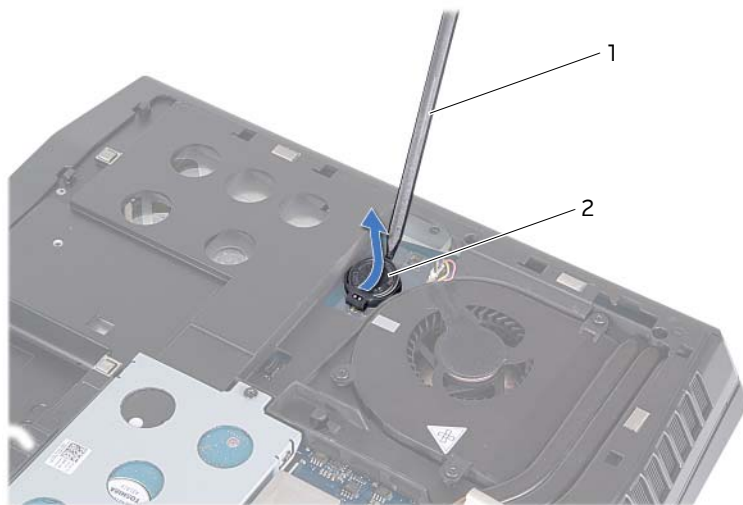

1 plastic scribe

2 coin-cell battery

8

Replacing the Coin-Cell Battery







WARNING: Before working inside your computer, read the safety information that shipped with your computer and follow the steps in "Before You Begin" on page 9. For additional safety best practices information, see the Regulatory Compliance Homepage at dell.com/regulatory_compliance.

Procedure

- 1 Hold the coin-cell battery with the positive side facing up.
- 2 Slide the coin-cell battery into the slot and gently press until it snaps into place.

Postrequisites

- 1 Replace the compartment door. See "Replacing the Compartment Door" on page 15.
- 2 Replace the battery pack. See "Replacing the Battery Pack" on page 13.
- 3 Follow the instructions in "After Working Inside Your Computer" on page 11.

-  **WARNING:** Before working inside your computer, read the safety information that shipped with your computer and follow the steps in "Before You Begin" on page 9. For additional safety best practices information, see the Regulatory Compliance Homepage at dell.com/regulatory_compliance.
-  **WARNING:** If you remove the hard drive from the computer when the drive is hot, *do not touch* the metal housing of the hard drive.
-  **CAUTION:** To help prevent damage to the system board, remove the main battery. See "Removing the Battery Pack" on page 12.
-  **CAUTION:** To prevent data loss, turn off your computer . See "Turn Off Your Computer and Connected Devices" on page 9. Do not remove the hard drive while the computer is On or in Sleep state.
-  **CAUTION:** Hard drives are extremely fragile. Exercise care when handling the hard drive.

Prerequisites

- 1 Remove the battery pack. See "Removing the Battery Pack" on page 12.
- 2 Remove the compartment door. See "Removing the Compartment Door" on page 14.

Procedure

- 1 Loosen the captive screws that secure the hard-drive assembly to the computer base.
- 2 Using the pull-tab, lift the hard-drive assembly to disconnect it from the connector on the system board.
- 3 Lift the hard-drive assembly out of the computer base.

Primary hard-drive assembly



-
- 1 captive screws (3)
 - 2 primary hard-drive assembly
-

Secondary hard-drive assembly

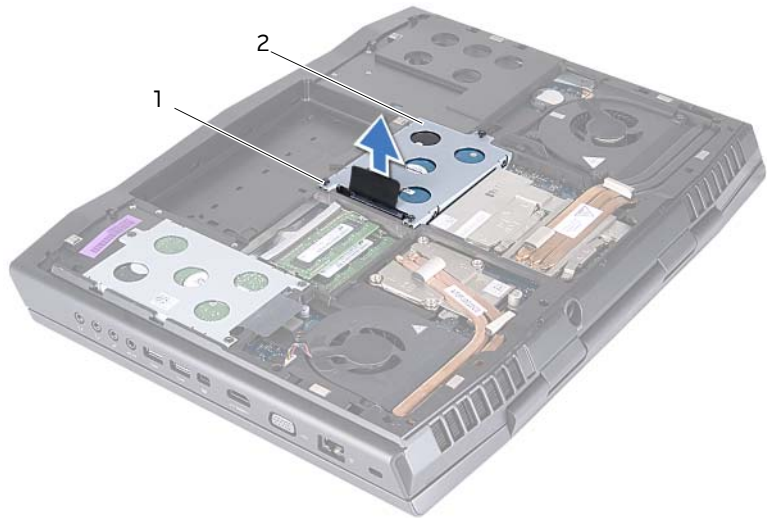

-
- 1 captive screws (3)
 - 2 secondary hard-drive assembly
-

- 4 Remove the screws that secure the hard drive to the hard-drive bracket.
- 5 Lift the hard-drive off the hard-drive bracket.
- 6 Remove the interposer from the hard drive.





1	interposer	2	screws (4)
3	hard drive	4	hard-drive bracket

⚠ CAUTION: When the hard drive is not in the computer, store it in protective antistatic packaging. See "Protecting Against Electrostatic Discharge" in the safety instructions that shipped with your computer.

 **WARNING:** Before working inside your computer, read the safety information that shipped with your computer and follow the steps in "Before You Begin" on page 9. For additional safety best practices information, see the Regulatory Compliance Homepage at dell.com/regulatory_compliance.

 **CAUTION:** Hard drives are extremely fragile. Exercise care when handling the hard drive.

 **NOTE:** Dell or Alienware does not guarantee compatibility or provide support for hard drives from sources other than Dell.

 **NOTE:** If you are installing a hard drive from a source other than Dell or Alienware, you need to install an operating system, drivers, and utilities on the new hard drive.

Procedure

- 1 Remove the new drive from its packaging.
Save the original packaging for storing or shipping the hard drive.
- 2 Connect the interposer to the hard drive.
- 3 Place the hard drive in the hard-drive bracket.
- 4 Replace the screws that secure the hard drive to the hard-drive bracket.
- 5 Align the connector on the hard drive with the connector on the system board and press the hard drive until it is fully seated.
- 6 Tighten the captive screws that secure the hard-drive assembly to the computer base.

Postrequisites

- 1 Replace the compartment door. See "Replacing the Compartment Door" on page 15.
- 2 Replace the battery pack. See "Replacing the Battery Pack" on page 13.
- 3 Follow the instructions in "After Working Inside Your Computer" on page 11.
- 4 Install the operating system for your computer, as needed.
- 5 Install the drivers and utilities for your computer, as needed.

⚠ WARNING: Before working inside your computer, read the safety information that shipped with your computer and follow the steps in "Before You Begin" on page 9. For additional safety best practices information, see the Regulatory Compliance Homepage at dell.com/regulatory_compliance.

✍ NOTE: Your computer supports up to four memory module connectors. You can access connectors DIMM 1 and DIMM 2 by removing the compartment door at the bottom of your computer. You can access connectors DIMM 3 and DIMM 4 by removing the memory-module cover on top of the palm rest assembly.

Prerequisites

- 1 Remove the battery pack. See "Removing the Battery Pack" on page 12.
- 2 Remove the compartment door. See "Removing the Compartment Door" on page 14.

Procedure

- 1 To remove memory module(s) from connectors DIMM 1 and DIMM 2, go to step 3.
- 2 To remove memory-module(s) from connectors DIMM 3 and DIMM 4:
 - a Remove the center control cover. See "Removing the Center Control Cover" on page 41.
 - b Remove the keyboard. See "Removing the Keyboard" on page 45.
 - c Remove the screws that secure the memory-module cover to the palm rest assembly.

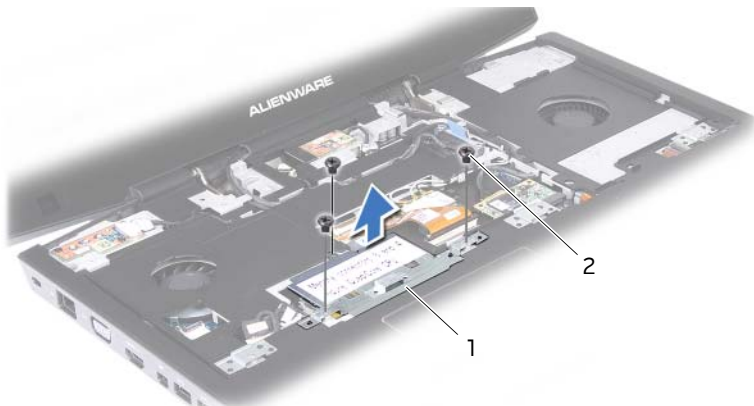

- | | | | |
|---|---------------------|---|------------|
| 1 | memory-module cover | 2 | screws (3) |
|---|---------------------|---|------------|

△ CAUTION: To prevent damage to the memory-module connector, do not use tools to spread the memory module securing clips.

- 3 Use your fingertips to carefully spread apart the securing clips on each end of the memory-module connector until the memory module pops up.

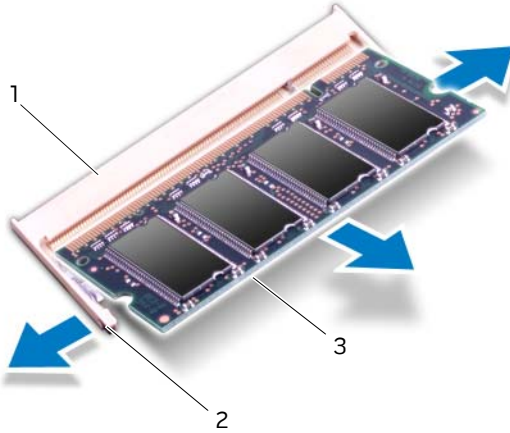

1 memory-module connector

2 securing clips (2)

3 memory module

- 4 Remove the memory module from the memory-module connector.



WARNING: Before working inside your computer, read the safety information that shipped with your computer and follow the steps in "Before You Begin" on page 9. For additional safety best practices information, see the Regulatory Compliance Homepage at dell.com/regulatory_compliance.



NOTE: Memory modules purchased from Dell or Alienware are covered under your computer warranty.



NOTE: If you purchased a dual-core processor, your computer supports only memory module connectors DIMM 1 and DIMM 2.



NOTE: Your computer supports up to four memory module connectors. You can access connectors DIMM 1 and DIMM 2 by removing the compartment door at the bottom of your computer. You can access connectors DIMM 3 and DIMM 4 by removing the memory-module cover on top of the palm rest assembly.

Procedure



NOTE: If you need to install memory modules in two connectors, install a memory module in the lower connector before you install a memory module in the upper connector.

- 1 Align the notch in the memory module with the tab on the memory-module connector.
- 2 Slide the memory module firmly into the connector at a 45-degree angle, and press the memory module down until it clicks into place. If you do not hear the click, remove the memory module and reinstall it.



NOTE: If the memory module is not installed properly, the computer may not boot.

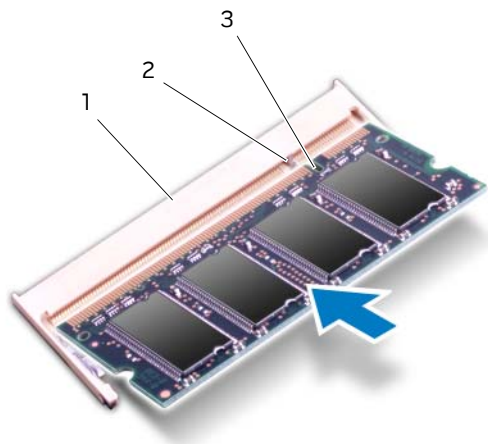

1	memory-module connector	2	tab
3	notch		

- 3** If you have replaced memory module(s) in connectors DIMM 1 and DIMM 2, go to Postrequisites.
- 4** If you have replaced memory module(s) in connectors DIMM 3 and DIMM 4:
 - a** Align the screw holes on the memory-module cover with the screw holes on the palm rest assembly.
 - b** Replace the screws that secure the memory-module cover to the palm rest assembly.
 - c** Replace the keyboard. See "Replacing the Keyboard" on page 48.
 - d** Replace the center control cover. See "Replacing the Center Control Cover" on page 44.

Postrequisites

- 1** Replace the compartment door. See "Replacing the Compartment Door" on page 15.
- 2** Replace the battery pack. See "Replacing the Battery Pack" on page 13.
- 3** Follow the instructions in "After Working Inside Your Computer" on page 11.

As the computer boots, it detects the additional memory and automatically updates the system configuration information.

To confirm the amount of memory installed in the computer:

Click **Start**  → **Control Panel** → **System and Security** → **System**.

13

Removing the Graphics-Card Heat Sink Fan



WARNING: Before working inside your computer, read the safety information that shipped with your computer and follow the steps in "Before You Begin" on page 9. For additional safety best practices information, see the Regulatory Compliance Homepage at dell.com/regulatory_compliance.



WARNING: The graphics-card assembly may be very hot during normal operation. Ensure that it has had sufficient time to cool before you touch it.

Prerequisites

- 1 Remove the battery pack. See "Removing the Battery Pack" on page 12.
- 2 Remove the compartment door. See "Removing the Compartment Door" on page 14.

Procedure

- 1 Disconnect the graphics-card heat sink fan cable from the connector on the system board.
- 2 Loosen the captive screws that secure the graphics-card heat sink fan to the chassis.
- 3 Lift the graphics-card heat sink fan along with the cable away from the computer base.



1	graphics-card heat sink fan cable	2	captive screws (3)
3	graphics-card heat sink fan		



WARNING: Before working inside your computer, read the safety information that shipped with your computer and follow the steps in "Before You Begin" on page 9. For additional safety best practices information, see the Regulatory Compliance Homepage at dell.com/regulatory_compliance.

Procedure



- 1 Align the screw holes on the graphics-card heat sink fan with the screw holes on the chassis.
- 2 Tighten the captive screws that secure the graphics-card heat sink fan to the chassis.
- 3 Connect the graphics-card heat sink fan cable to the connector on the system board.

Postrequisites

- 1 Replace the compartment door. See "Replacing the Compartment Door" on page 15.
- 2 Replace the battery pack. See "Replacing the Battery Pack" on page 13.
- 3 Follow the instructions in "After Working Inside Your Computer" on page 11.

15

Removing the Processor Heat-Sink Fan

-  **WARNING:** Before working inside your computer, read the safety information that shipped with your computer and follow the steps in "Before You Begin" on page 9. For additional safety best practices information, see the Regulatory Compliance Homepage at dell.com/regulatory_compliance.
-  **WARNING:** The processor heat-sink may be very hot during normal operation. Ensure that it has had sufficient time to cool before you touch it.

Prerequisites

- 1 Remove the battery pack. See "Removing the Battery Pack" on page 12.
- 2 Remove the compartment door. See "Removing the Compartment Door" on page 14.

Procedure

- 1 Disconnect the processor heat-sink fan cable from the connector on the system board.
- 2 Loosen the captive screws that secure the processor heat-sink fan to the chassis.
- 3 Lift the processor heat-sink fan along with the cable away from the chassis.

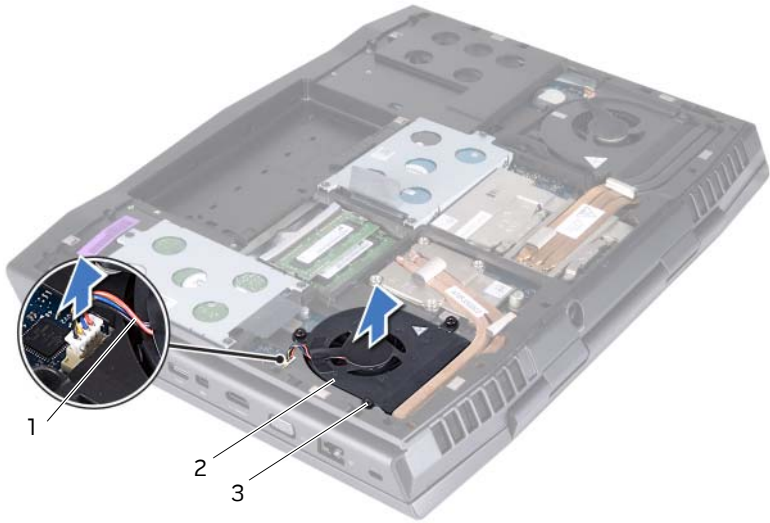

1	processor heat-sink fan cable	2	processor heat-sink fan
3	captive screws (3)		

16

Replacing the Processor Heat-Sink Fan



WARNING: Before working inside your computer, read the safety information that shipped with your computer and follow the steps in "Before You Begin" on page 9. For additional safety best practices information, see the Regulatory Compliance Homepage at dell.com/regulatory_compliance.

Procedure

- 1 Align the screw holes on the processor heat-sink fan with the screw holes on the chassis.
- 2 Tighten the captive screws that secure the processor heat-sink fan to the chassis.
- 3 Connect the processor heat-sink fan cable to the connector on the system board.

Postrequisites

- 1 Replace the compartment door. See "Replacing the Compartment Door" on page 15.
- 2 Replace the battery pack. See "Replacing the Battery Pack" on page 13.
- 3 Follow the instructions in "After Working Inside Your Computer" on page 11.



WARNING: Before working inside your computer, read the safety information that shipped with your computer and follow the steps in "Before You Begin" on page 9. For additional safety best practices information, see the Regulatory Compliance Homepage at dell.com/regulatory_compliance.



WARNING: The graphics-card assembly may be very hot during normal operation. Ensure that it has had sufficient time to cool before you touch it.

Prerequisites

- 1 Remove the battery pack. See "Removing the Battery Pack" on page 12.
- 2 Remove the compartment door. See "Removing the Compartment Door" on page 14.
- 3 Remove the graphics-card heat sink fan. See "Removing the Graphics-Card Heat Sink Fan" on page 26.

Procedure

- 1 Remove the screws that secure the graphics-card assembly to the system board.
- 2 Lift and slide the graphics-card assembly to disconnect it from the connector on the system board.



1	graphics-card assembly	2	screws (2)
---	------------------------	---	------------



WARNING: Before working inside your computer, read the safety information that shipped with your computer and follow the steps in "Before You Begin" on page 9. For additional safety best practices information, see the Regulatory Compliance Homepage at dell.com/regulatory_compliance.

Procedure

- 1 Insert the graphics card connector at a 45-degree angle into the connector on the system board.
- 2 Press the other end of the graphics-card assembly down into the slot on the system board and replace the two screws that secure the graphics-card assembly to the system board.

Postrequisites

- 1 Replace the graphics-card heat sink fan. See "Replacing the Graphics-Card Heat Sink Fan" on page 28.
- 2 Replace the compartment door. See "Replacing the Compartment Door" on page 15.
- 3 Replace the battery pack. See "Replacing the Battery Pack" on page 13.
- 4 Follow the instructions in "After Working Inside Your Computer" on page 11.



WARNING: Before working inside your computer, read the safety information that shipped with your computer and follow the steps in "Before You Begin" on page 9. For additional safety best practices information, see the Regulatory Compliance Homepage at dell.com/regulatory_compliance.



WARNING: If you remove the processor heat-sink from the computer when the heat sink is hot, *do not touch* the metal housing of the processor heat-sink.

Prerequisites

- 1 Remove the battery pack. See "Removing the Battery Pack" on page 12.
- 2 Remove the compartment door. See "Removing the Compartment Door" on page 14.
- 3 Remove the processor heat-sink fan. See "Removing the Processor Heat-Sink Fan" on page 29.

Procedure

- 1 In sequential order (indicated on the processor heat-sink), loosen the captive screws that secure the processor heat-sink to the system board.
- 2 Lift the processor heat-sink at an angle toward the front of the computer and out of the computer base.

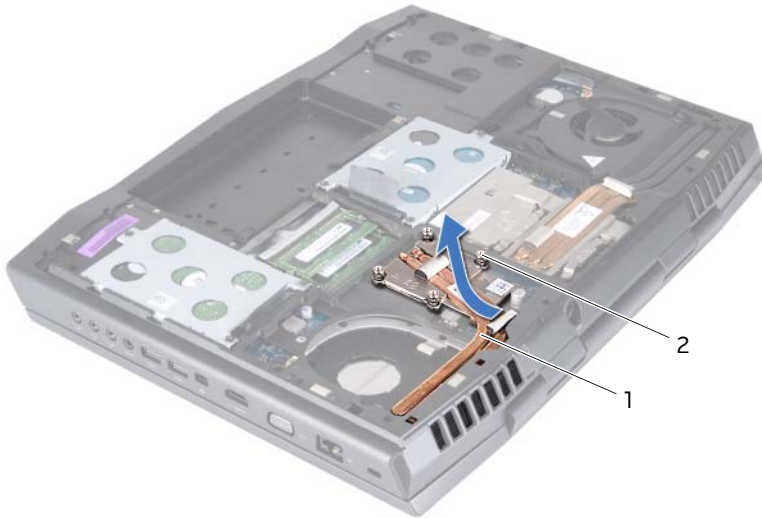

1	processor heat-sink	2	captive screws (4)
---	---------------------	---	--------------------

 **WARNING:** Before working inside your computer, read the safety information that shipped with your computer and follow the steps in "Before You Begin" on page 9. For additional safety best practices information, see the Regulatory Compliance Homepage at dell.com/regulatory_compliance.

 **CAUTION:** Incorrect alignment of the processor heat-sink can damage the processor.

 **NOTE:** The original thermal grease can be reused if the original processor heat-sink is reinstalled. If the processor heat-sink is replaced, use the thermal grease provided in the kit to ensure that thermal conductivity is achieved.

Procedure

- 1 Slide the processor heat-sink in place.
- 2 Align the captive screws on the processor heat-sink with the screw holes on the system board and tighten the screws in sequential order (indicated on the processor heat-sink).

Postrequisites

- 1 Replace the processor heat-sink fan. See "Replacing the Processor Heat-Sink Fan" on page 31.
- 2 Replace the compartment door. See "Replacing the Compartment Door" on page 15.
- 3 Replace the battery pack. See "Replacing the Battery Pack" on page 13.
- 4 Follow the instructions in "After Working Inside Your Computer" on page 11.

⚠ WARNING: Before working inside your computer, read the safety information that shipped with your computer and follow the steps in "Before You Begin" on page 9. For additional safety best practices information, see the Regulatory Compliance Homepage at dell.com/regulatory_compliance.

Prerequisites

⚠ CAUTION: To prevent intermittent contact between the ZIF-socket cam screw and the processor module when removing the processor, press to apply slight pressure to the center of the processor module while turning the cam screw.

⚠ CAUTION: To avoid damage to the processor module, hold the screwdriver so that it is perpendicular to the processor module when turning the cam screw.

- 1 Remove the battery pack. See "Removing the Battery Pack" on page 12.
- 2 Remove the compartment door. See "Removing the Compartment Door" on page 14.
- 3 Remove the processor heat-sink fan. See "Removing the Processor Heat-Sink Fan" on page 29.
- 4 Remove the processor heat-sink. See "Removing the Processor Heat-Sink" on page 35.

Procedure

- 1 To loosen the ZIF socket, use a small, flat-blade screwdriver and rotate the ZIF-socket cam screw counterclockwise until it comes to the cam stop.

⚠ CAUTION: To ensure maximum cooling for the processor module, do not touch the heat transfer areas on the processor thermal cooling assembly. The oils in your skin can reduce the heat transfer capability of the thermal pads.

⚠ CAUTION: When removing the processor module, lift the module straight up. Be careful not to bend the pins on the processor module.

2 Lift the processor module from the ZIF socket.

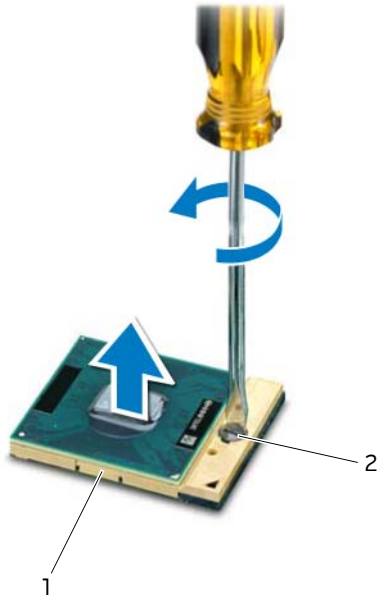

-
- | | | | |
|---|------------|---|----------------------|
| 1 | ZIF socket | 2 | ZIF-socket cam screw |
|---|------------|---|----------------------|
-

 **WARNING:** Before working inside your computer, read the safety information that shipped with your computer. For additional safety best practices information, see the Regulatory Compliance Homepage at www.dell.com/regulatory_compliance.

Procedure

 **NOTE:** If a new processor module is installed, you will receive a new thermal-cooling assembly, which will include an affixed thermal pad, or you will receive a new thermal pad along with documentation to illustrate proper installation.

- 1 Align the pin-1 corner of the processor module with the pin-1 corner of the ZIF socket, then place the processor module.

 **NOTE:** The pin-1 corner of the processor module has a triangle that aligns with the triangle on the pin-1 corner of the ZIF socket.

When the processor module is properly seated, all four corners are aligned at the same height. If one or more corners of the module are higher than the others, the module is not seated properly.

 **CAUTION:** To prevent intermittent contact between the ZIF-socket cam screw and the processor module when replacing the processor, press to apply slight pressure to the center of the processor module while turning the cam screw.

 **CAUTION:** To avoid damage to the processor module, hold the screwdriver perpendicular to the processor module when turning the cam screw.

- 2 Tighten the ZIF socket by turning the cam screw clockwise to secure the processor module to the ZIF socket.

Postrequisites

- 1 Replace the processor heat-sink. See "Replacing the Processor Heat-Sink" on page 37.
- 2 Replace the processor heat-sink fan. See "Replacing the Processor Heat-Sink Fan" on page 31.
- 3 Replace the compartment door. See "Replacing the Compartment Door" on page 15.
- 4 Replace the battery pack. See "Replacing the Battery Pack" on page 13.

23

Removing the Center Control Cover

⚠ WARNING: Before working inside your computer, read the safety information that shipped with your computer and follow the steps in "Before You Begin" on page 9. For additional safety best practices information, see the Regulatory Compliance Homepage at dell.com/regulatory_compliance.

Prerequisites

- 1 Remove the battery pack. See "Removing the Battery Pack" on page 12.
- 2 Remove the compartment door. See "Removing the Compartment Door" on page 14.

Procedure

- 1 Remove the screws that secure the center control cover to the computer base.

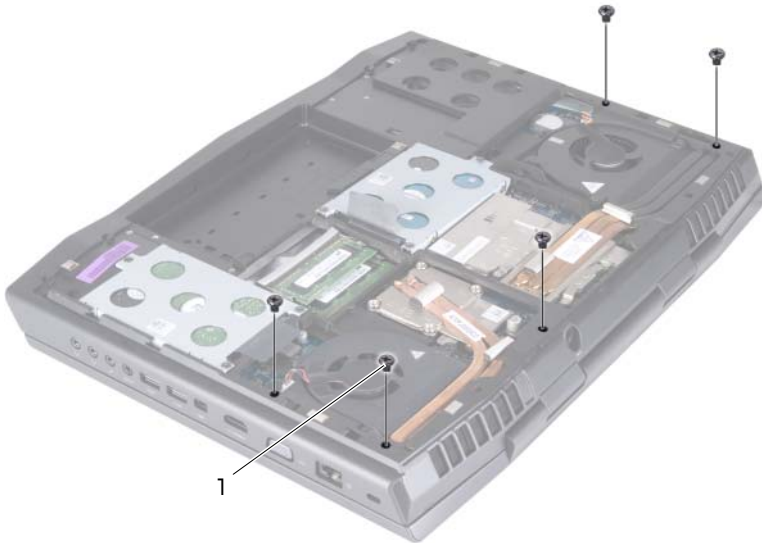

1 screws (5)

⚠ CAUTION: Be extremely careful when removing the center control cover. The cover along with the cable that attaches to it are fragile.

- 2 Turn the computer over and open the display as far as possible.

- 3 Gently pry the center control cover from the back of the computer and then ease the tabs on the center control cover out of the slots on the palm rest assembly.



1 center control cover



CAUTION: Be extremely careful when removing and handling the center control cover. Failure to do so could result in scratching the display panel.

- 4 Turn the center control cover towards the display.
- 5 Disconnect the media control keys cable from the connector on the system board.
- 6 Lift the center control cover away from the computer.



1 media control keys cable



WARNING: Before working inside your computer, read the safety information that shipped with your computer and follow the steps in "Before You Begin" on page 9. For additional safety best practices information, see the Regulatory Compliance Homepage at dell.com/regulatory_compliance.

Procedure

- 1 Connect the media control keys cable to the connector on the system board.
- 2 Align the tabs on the center control cover with the slots on the palm rest assembly and snap the center control cover into place.
- 3 Close the display and turn the computer over.
- 4 Replace the screws that secure the center control cover to the computer base.

Postrequisites

- 1 Replace the compartment door. See "Replacing the Compartment Door" on page 15.
- 2 Replace the battery pack. See "Replacing the Battery Pack" on page 13.

 **WARNING:** Before working inside your computer, read the safety information that shipped with your computer and follow the steps in "Before You Begin" on page 9. For additional safety best practices information, see the Regulatory Compliance Homepage at dell.com/regulatory_compliance.

Prerequisites

- 1 Remove the battery pack. See "Removing the Battery Pack" on page 12.
- 2 Remove the compartment door. See "Replacing the Compartment Door" on page 15.
- 3 Remove the center control cover. See "Removing the Center Control Cover" on page 41.

Procedure

- 1 Remove the screws that secure the keyboard to the computer base.

 **CAUTION:** The keycaps on the keyboard are fragile, easily dislodged, and time-consuming to replace. Be careful when removing and handling the keyboard.

 **CAUTION:** Be extremely careful when removing and handling the keyboard. Failure to do so could result in scratching the display panel.

- 2 Carefully lift the keyboard and slide the keyboard tabs out of the slots on the palm rest assembly.
- 3 Carefully turn the keyboard over and place it on the palm rest assembly.



1 screws (5)

2 keyboard

- 4** Lift the release latches on the connectors on the system board and disconnect the keyboard cable and backlit keyboard cable.

5 Lift the keyboard off the palm rest assembly.



1 keyboard cable

2 backlit keyboard cable

 **WARNING:** Before working inside your computer, read the safety information that shipped with your computer and follow the steps in "Before You Begin" on page 9. For additional safety best practices information, see the Regulatory Compliance Homepage at dell.com/regulatory_compliance.

Procedure

- 1 Slide the keyboard cable and backlit keyboard cable into their connectors on the system board and press down on their connector latches to secure the cables.
- 2 Slide the tabs on the keyboard into the slots on the palm rest assembly and lower the keyboard into place.
- 3 Replace the screws that secure the keyboard to the computer base.

Postrequisites

- 1 Replace the center control cover. See "Replacing the Center Control Cover" on page 44.
- 2 Replace the compartment door. See "Replacing the Compartment Door" on page 15.
- 3 Replace the battery pack. See "Replacing the Battery Pack" on page 13.
- 4 Follow the instructions in "After Working Inside Your Computer" on page 11.

 **WARNING:** Before working inside your computer, read the safety information that shipped with your computer and follow the steps in "Before You Begin" on page 9. For additional safety best practices information, see the Regulatory Compliance Homepage at dell.com/regulatory_compliance.

If you ordered a wireless Mini-Card with your computer, the card is already installed. Your computer supports one half Mini-Card slot for WLAN.

 **NOTE:** Depending on the configuration of the computer when it was sold, the Mini-Card slot may or may not have a Mini-Card installed.

Prerequisites

- 1 Remove the battery pack. See "Removing the Battery Pack" on page 12.
- 2 Remove the compartment door. See "Removing the Compartment Door" on page 14.
- 3 Remove the center control cover. See "Removing the Center Control Cover" on page 41.
- 4 Remove the keyboard. See "Removing the Keyboard" on page 45.

Procedure

- 1 Disconnect the antenna cables from the Mini-Card.
- 2 Remove the screw that secures the Mini-Card to the system board.

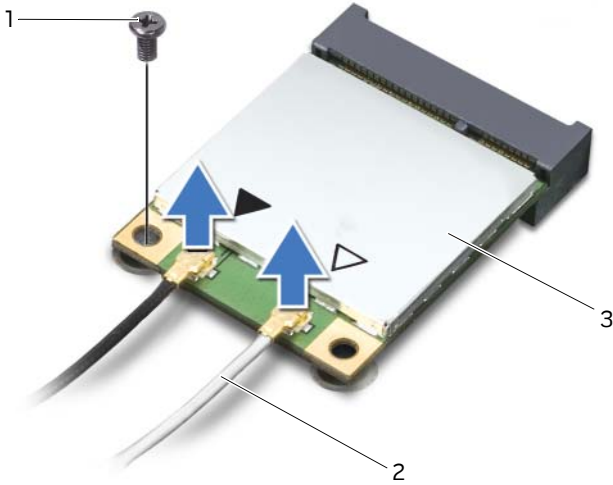

1	screw	2	antenna cables (2)
3	Mini-Card		

- 3 Lift the Mini-Card out of the connector on the system board.

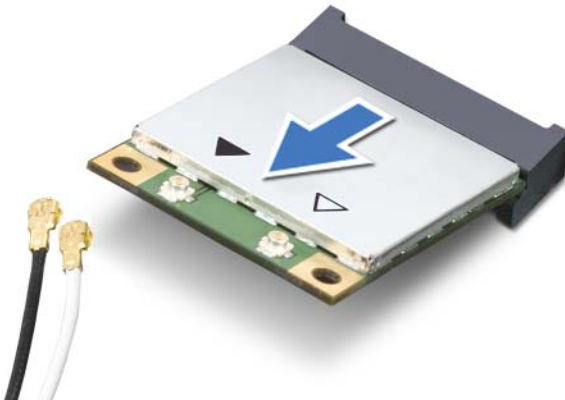

⚠ CAUTION: When the Mini-Card is not in the computer, store it in protective antistatic packaging. For more information, see "Protecting Against Electrostatic Discharge" in the safety information that shipped with your computer.

⚠ WARNING: Before working inside your computer, read the safety information that shipped with your computer and follow the steps in "Before You Begin" on page 9. For additional safety best practices information, see the Regulatory Compliance Homepage at dell.com/regulatory_compliance.

🔪 NOTE: Dell or Alienware does not guarantee compatibility or provide support for Mini-Cards from sources other than Dell or Alienware.

Your computer supports one half Mini-Card slot for WLAN.

🔪 NOTE: Depending on the configuration of the computer when it was sold, the Mini-Card slot may or may not have a Mini-Card installed.

Procedure

- 1 Remove the new Mini-Card from its packaging.

⚠ CAUTION: Use firm and even pressure to slide the card into place. If you use excessive force, you may damage the connector.

⚠ CAUTION: The connectors are keyed to ensure correct insertion. If you feel resistance, check the connectors on the card and on the system board, and realign the card.

- 2 Insert the Mini-Card connector at a 45-degree angle into the connector on the system board.
- 3 Press the other end of the Mini-Card down into the slot on the system board and replace the screw that secures the Mini-Card to the system board.
- 4 Connect the appropriate antenna cables to the Mini-Card you are installing. The following table provides the antenna cable color scheme for the Mini-Card supported by your computer.

Connectors on the Mini-Card	Antenna Cable Color Scheme
WLAN (2 or 3 antenna cables)	
Main WLAN (white triangle)	white
Auxiliary WLAN (black triangle)	black
MIMO WLAN (gray triangle) (optional)	gray

Postrequisites

- 1 Replace the keyboard. See "Replacing the Keyboard" on page 48.
- 2 Replace the center control cover. See "Replacing the Center Control Cover" on page 44.
- 3 Replace the compartment door. See "Replacing the Compartment Door" on page 15.
- 4 Replace the battery pack. See "Replacing the Battery Pack" on page 13.
- 5 Follow the instructions in "After Working Inside Your Computer" on page 11.
- 6 Install the drivers and utilities for your computer, as required.



NOTE: If you are installing a Mini-card from a source other than Dell or Alienware, you must install the appropriate drivers and utilities.

⚠ WARNING: Before working inside your computer, read the safety information that shipped with your computer and follow the steps in "Before You Begin" on page 9. For additional safety best practices information, see the Regulatory Compliance Homepage at dell.com/regulatory_compliance.

If you ordered a wirelessHD card with your computer, the card is already installed.

Prerequisites

- 1 Remove the battery pack. See "Removing the Battery Pack" on page 12.
- 2 Remove the compartment door. See "Removing the Compartment Door" on page 14.
- 3 Remove the center control cover. See "Removing the Center Control Cover" on page 41.
- 4 Remove the keyboard. See "Removing the Keyboard" on page 45.

Procedure

- 1 Disconnect the wirelessHD card cable from the connector on the wirelessHD card.
- 2 Remove the screw that secures the wirelessHD card to the system board.
- 3 Lift the wirelessHD card out of the connector on the system board.

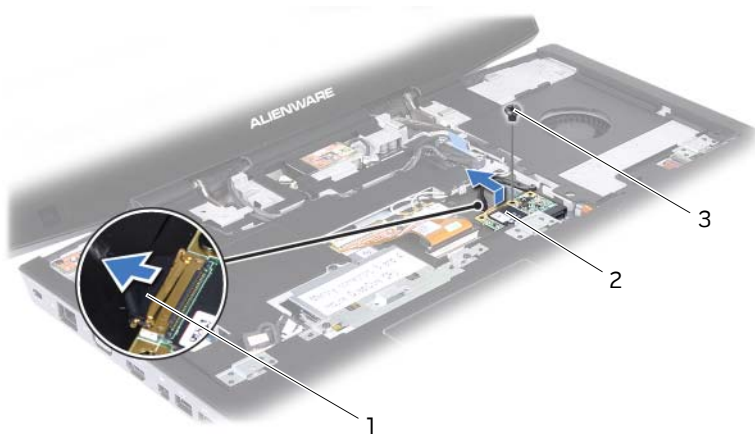

1 wirelessHD card cable

2 wirelessHD card

3 screw

 **WARNING:** Before working inside your computer, read the safety information that shipped with your computer and follow the steps in "Before You Begin" on page 9. For additional safety best practices information, see the Regulatory Compliance Homepage at dell.com/regulatory_compliance.

If you ordered a wirelessHD card with your computer, the card is already installed.

Procedure

- 1 Remove the new wirelessHD card from its packaging.

 **CAUTION:** Use firm and even pressure to slide the card into place. If you use excessive force, you may damage the connector.

 **CAUTION:** The connectors are keyed to ensure correct insertion. If you feel resistance, check the connectors on the card and on the system board, and realign the card.

- 2 Insert the wirelessHD card connector at a 45-degree angle into the connector on the system board.
- 3 Press the other end of the wirelessHD card down into the slot on the system board and replace the screw that secures the wirelessHD card to the system board.
- 4 Connect the wirelessHD card cable to the connector on the wirelessHD card.

Postrequisites

- 1 Replace the keyboard. See "Replacing the Keyboard" on page 48.
- 2 Replace the center control cover. See "Replacing the Center Control Cover" on page 44.
- 3 Replace the compartment door. See "Replacing the Compartment Door" on page 15.
- 4 Replace the battery pack. See "Replacing the Battery Pack" on page 13.
- 5 Follow the instructions in "After Working Inside Your Computer" on page 11.

31

Removing the Power Button Board

⚠ WARNING: Before working inside your computer, read the safety information that shipped with your computer and follow the steps in "Before You Begin" on page 9. For additional safety best practices information, see the Regulatory Compliance Homepage at dell.com/regulatory_compliance.

Prerequisites

- 1 Remove the battery pack. See "Removing the Battery Pack" on page 12.
- 2 Remove the compartment door. See "Removing the Compartment Door" on page 14.
- 3 Remove the center control cover. See "Removing the Center Control Cover" on page 41.
- 4 Remove the keyboard. See "Removing the Keyboard" on page 45.

Procedure

- 1 Disconnect the power button board cable from the connector on the system board.
- 2 Remove the screws that secure the power button board to the palm rest assembly.
- 3 Lift the power button board off the palm rest assembly.

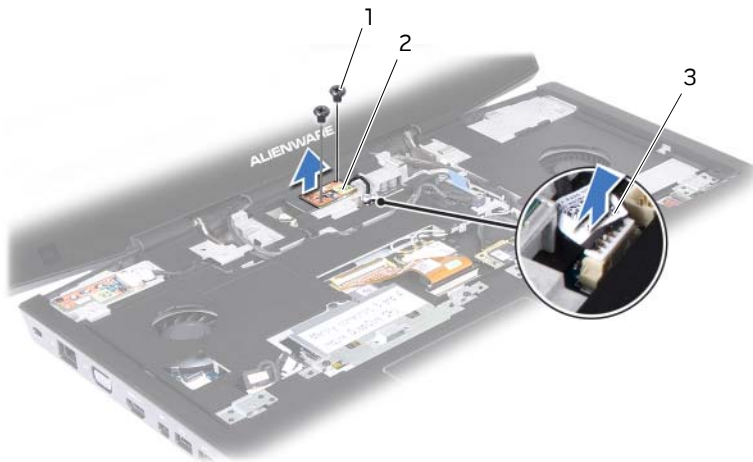

1 screws (2)

2 power button board

3 power button board cable



WARNING: Before working inside your computer, read the safety information that shipped with your computer and follow the steps in "Before You Begin" on page 9. For additional safety best practices information, see the Regulatory Compliance Homepage at dell.com/regulatory_compliance.

Procedure

- 1 Align the slots on the power button board with the alignment posts on the chassis and secure the power button board in place.
- 2 Replace the screws that secure the power button board to the palm rest assembly.
- 3 Connect the power button board cable to the connector on the system board.

Postrequisites

- 1 Replace the keyboard. See "Replacing the Keyboard" on page 48.
- 2 Replace the center control cover. See "Removing the Center Control Cover" on page 41.
- 3 Replace the compartment door. See "Replacing the Compartment Door" on page 15.
- 4 Replace the battery pack. See "Replacing the Keyboard" on page 48.
- 5 Follow the instructions in "After Working Inside Your Computer" on page 11.



WARNING: Before working inside your computer, read the safety information that shipped with your computer and follow the steps in "Before You Begin" on page 9. For additional safety best practices information, see the Regulatory Compliance Homepage at dell.com/regulatory_compliance.

Prerequisites

- 1 Remove the battery pack. See "Removing the Battery Pack" on page 12.
- 2 Remove the compartment door. See "Removing the Compartment Door" on page 14.
- 3 Remove the center control cover. See "Removing the Center Control Cover" on page 41.
- 4 Remove the keyboard. See "Removing the Keyboard" on page 45.
- 5 Disconnect the antenna cables from the Mini-Card. See "Removing the Mini-Card" on page 49.
- 6 Disconnect the wirelessHD card cable from the connector on the wirelessHD card. See "Removing the WirelessHD Card" on page 53.

Procedure

- 1 Loosen the captive screws that secure the display cable to the system board.
- 2 Using the pull-tab, pull the display cable to disconnect the display cable from the connector on the system board.
- 3 Disconnect the camera cable and infrared cable from the respective system board connectors.
- 4 Note the routing of the display cable, camera cable, infrared cable, wirelessHD card cable, Mini-Card antenna cables and remove the cables from the routing guides on the palm rest assembly.

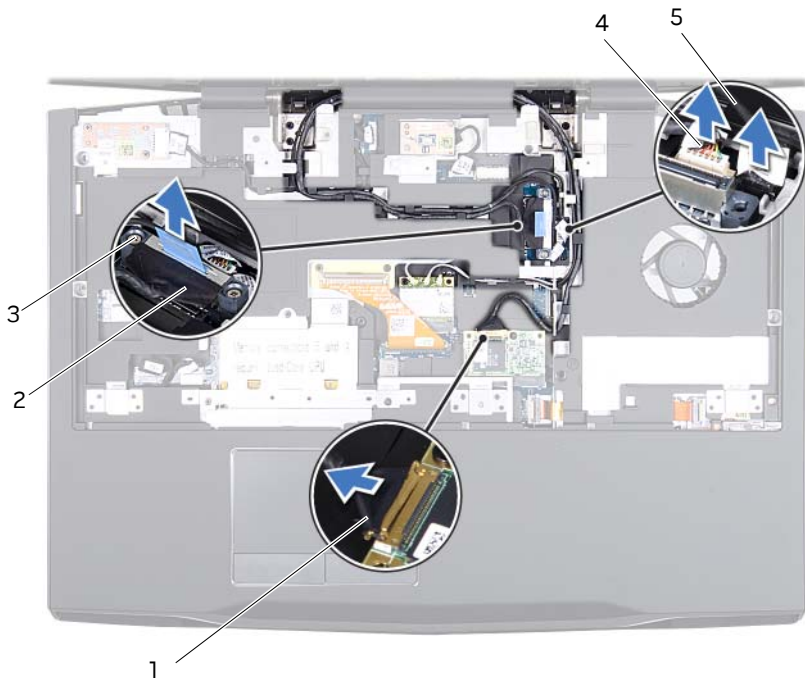

1	wirelessHD card cable	2	display cable
3	captive screws (2)	4	camera cable
5	infrared cable		

- 5** Remove the screws that secure the display assembly to the computer base.
- 6** Lift the display assembly off the computer.



1 display assembly

2 screws (6)



WARNING: Before working inside your computer, read the safety information that shipped with your computer and follow the steps in "Before You Begin" on page 9. For additional safety best practices information, see the Regulatory Compliance Homepage at dell.com/regulatory_compliance.

Procedure

- 1 Place the display assembly in position and replace the screws that secure the display assembly to the computer base.
- 2 Route the display cable, camera cable, infrared cable, wirelessHD card cable, and Mini-Card antenna cables through the routing guides on the palm rest assembly.
- 3 Connect the display cable to the connector on the system board.
- 4 Tighten the captive screws that secure the display cable to the system board.
- 5 Connect the camera cable and infrared cable to the respective system board connectors.

Postrequisites

- 1 Connect the wirelessHD card cable to the connector on the wirelessHD card. See "Replacing the WirelessHD Card" on page 54.
- 2 Connect the Mini-Card antenna cables to the Mini-Card. See "Replacing the Mini-Card" on page 51.
- 3 Replace the keyboard. See "Replacing the Keyboard" on page 48.
- 4 Replace the center control cover. See "Replacing the Center Control Cover" on page 44.
- 5 Replace the compartment door. See "Replacing the Compartment Door" on page 15.
- 6 Replace the battery pack. See "Replacing the Battery Pack" on page 13.
- 7 Follow the instructions in "After Working Inside Your Computer" on page 11.

 **WARNING:** Before working inside your computer, read the safety information that shipped with your computer and follow the steps in "Before You Begin" on page 9. For additional safety best practices information, see the Regulatory Compliance Homepage at dell.com/regulatory_compliance.

Prerequisites

- 1 Remove the battery pack. See "Removing the Battery Pack" on page 12.
- 2 Remove the compartment door. See "Removing the Compartment Door" on page 14.
- 3 Remove the center control cover. See "Removing the Center Control Cover" on page 41.
- 4 Remove the keyboard. See "Removing the Keyboard" on page 45.
- 5 Remove the display assembly. See "Removing the Display Assembly" on page 57.

Procedure

- 1 Disconnect the status light board cable from the connector on the system board.
- 2 Note the routing of status light board cable and remove the cable from the routing guides.
- 3 Remove the screws that secure the status light board to the palm rest assembly.
- 4 Lift the status light board off the palm rest assembly.

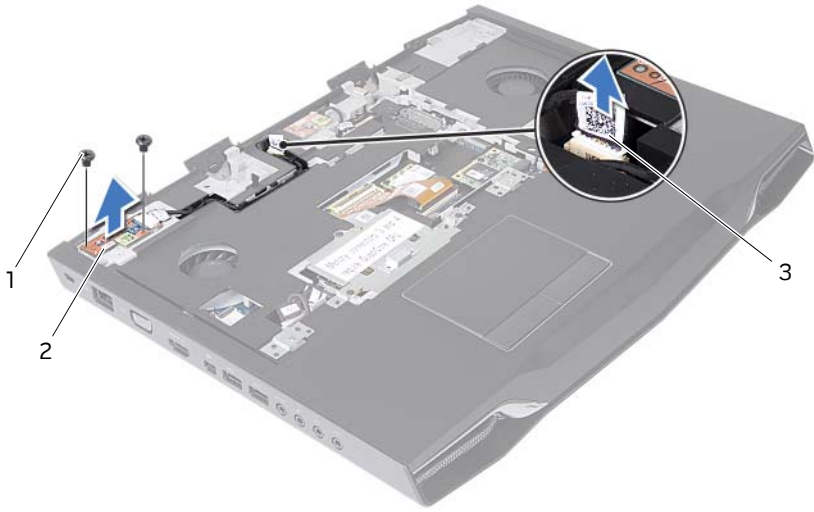

1	screws (2)	2	status light board
3	status light board cable		



WARNING: Before working inside your computer, read the safety information that shipped with your computer and follow the steps in "Before You Begin" on page 9. For additional safety best practices information, see the Regulatory Compliance Homepage at dell.com/regulatory_compliance.

Procedure

- 1 Align the slots on the status light board with the alignment posts on the palm rest assembly and secure the status light board in place.
- 2 Replace the screws that secure the status light board to the palm rest assembly.
- 3 Route the status light board cable through the routing guides on the palm rest assembly.
- 4 Connect the status light board cable to the connector on the system board.

Postrequisites

- 1 Replace the display assembly. See "Replacing the Display Assembly" on page 60.
- 2 Replace the keyboard. See "Replacing the Keyboard" on page 48.
- 3 Replace the center control cover. See "Replacing the Center Control Cover" on page 44.
- 4 Replace the compartment door. See "Replacing the Compartment Door" on page 15.
- 5 Replace the battery pack. See "Replacing the Battery Pack" on page 13.
- 6 Follow the instructions in "After Working Inside Your Computer" on page 11.

37

Removing the Palm Rest Assembly

⚠ WARNING: Before working inside your computer, read the safety information that shipped with your computer and follow the steps in "Before You Begin" on page 9. For additional safety best practices information, see the Regulatory Compliance Homepage at dell.com/regulatory_compliance.

Prerequisites

- 1 Remove any installed card or blank from the 9-in-1 Media Card Reader.
- 2 Remove the battery pack. See "Removing the Battery Pack" on page 12.
- 3 Remove the compartment door. See "Removing the Compartment Door" on page 14.
- 4 Remove the screws that secure the palm rest assembly to the computer base.

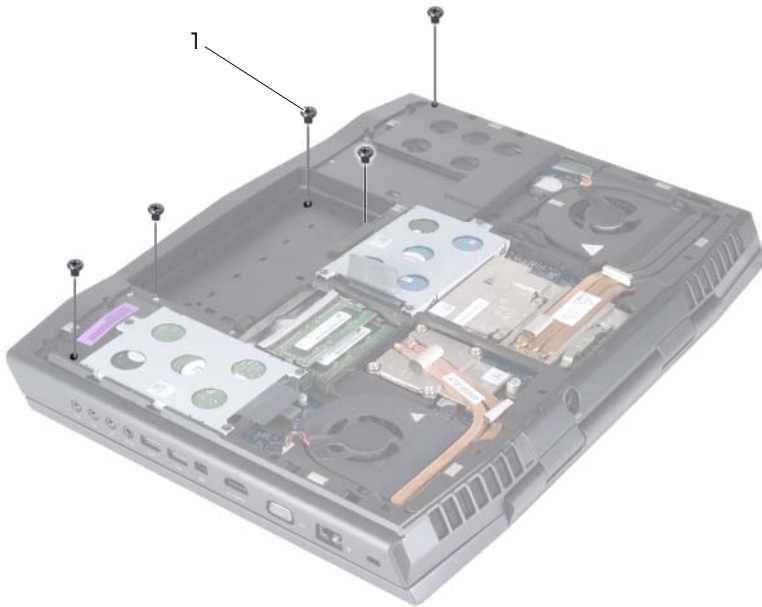

1 screws (5)

- 5 Remove the center control cover. See "Removing the Center Control Cover" on page 41.
- 6 Remove the keyboard. See "Removing the Keyboard" on page 45.

- 7 Remove the power button board. See "Removing the Power Button Board" on page 55.
- 8 Remove the display assembly. See "Removing the Display Assembly" on page 57.
- 9 Remove the status light board. See "Removing the Status Light Board" on page 61.

Procedure

- 1 Disconnect the touch pad cable, LVDS cable, and Media Card Reader cable from the connectors on the system board.
- 2 Remove the screws that secure the palm rest assembly to the computer base.
- 3 Carefully pry out the palm rest assembly along the rear edge and then ease the palm rest assembly from the computer base.

CAUTION: Carefully separate the palm rest assembly from the computer base to avoid damage to the palm rest assembly.

- 4 Lift the palm rest assembly off the computer base.

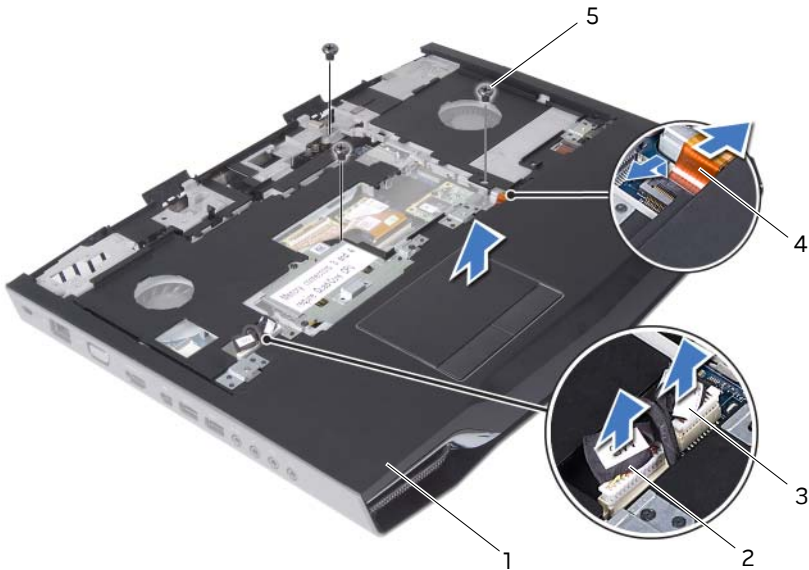

1	palm rest assembly	2	LVDS cable
3	touch pad cable	4	Media Card Reader cable
5	screws (3)		



WARNING: Before working inside your computer, read the safety information that shipped with your computer and follow the steps in "Before You Begin" on page 9. For additional safety best practices information, see the Regulatory Compliance Homepage at dell.com/regulatory_compliance.

Procedure

- 1 Align the screw holes on the palm rest assembly with the screw holes on the computer base.
- 2 Replace the screws that secure the palm rest assembly to the computer base.
- 3 Connect the touch pad cable, LVDS cable, and Media Card Reader cable to the connectors on the system board.

Postrequisites

- 1 Replace the status light board. See "Replacing the Status Light Board" on page 63.
- 2 Replace the display assembly. See "Replacing the Display Assembly" on page 60.
- 3 Replace the power button board. See "Replacing the Power Button Board" on page 56.
- 4 Replace the keyboard. See "Replacing the Keyboard" on page 48.
- 5 Replace the center control cover. See "Replacing the Center Control Cover" on page 44.
- 6 Turn the computer over and replace the screws that secure the palm rest assembly to the computer base.
- 7 Replace the compartment door. See "Replacing the Compartment Door" on page 15.
- 8 Replace the battery pack. See "Replacing the Battery Pack" on page 13.
- 9 Replace any cards or blank that you removed from the 9-in-1 Media Card Reader.
- 10 Follow the instructions in "After Working Inside Your Computer" on page 11.

 **WARNING:** Before working inside your computer, read the safety information that shipped with your computer and follow the steps in "Before You Begin" on page 9. For additional safety best practices information, see the Regulatory Compliance Homepage at dell.com/regulatory_compliance.

If you ordered a card with Bluetooth wireless technology with your computer, it is already installed.

Prerequisites

- 1 Remove the battery pack. See "Removing the Battery Pack" on page 12.
- 2 Remove the compartment door. See "Removing the Compartment Door" on page 14.
- 3 Remove the center control cover. See "Removing the Center Control Cover" on page 41.
- 4 Remove the keyboard. See "Removing the Keyboard" on page 45.
- 5 Remove the power button board. See "Removing the Power Button Board" on page 55.
- 6 Remove the display assembly. See "Removing the Display Assembly" on page 57.
- 7 Remove the status light board. See "Removing the Status Light Board" on page 61.
- 8 Remove the palm rest assembly. See "Removing the Palm Rest Assembly" on page 64.

Procedure

- 1 Disconnect the Bluetooth-card cable from the connector on the system board.
- 2 Remove the screw that secures the Bluetooth card to the system board.
- 3 Lift the Bluetooth card away from the system board.

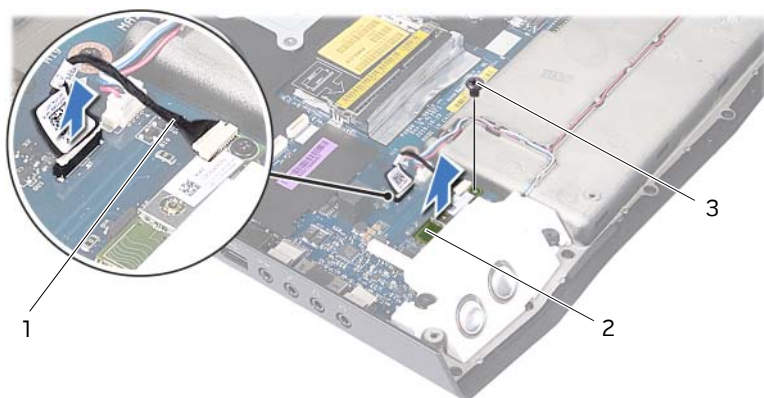

1 Bluetooth-card cable

2 Bluetooth card

3 screw

 **WARNING:** Before working inside your computer, read the safety information that shipped with your computer and follow the steps in "Before You Begin" on page 9. For additional safety best practices information, see the Regulatory Compliance Homepage at dell.com/regulatory_compliance.

Procedure

- 1 Align the screw hole on the Bluetooth card with the screw hole on the system board.
- 2 Replace the screw that secures the Bluetooth card to the system board.
- 3 Connect the Bluetooth-card cable to the connector on the system board.

Postrequisites

- 1 Replace the palm rest assembly. See "Replacing the Palm Rest Assembly" on page 66.
- 2 Replace the status light board. See "Replacing the Status Light Board" on page 63.
- 3 Replace the display assembly. See "Replacing the Display Assembly" on page 60.
- 4 Replace the power button board. See "Replacing the Power Button Board" on page 56.
- 5 Replace the keyboard. See "Replacing the Keyboard" on page 48.
- 6 Replace the center control cover. See "Replacing the Center Control Cover" on page 44.
- 7 Replace the compartment door. See "Replacing the Compartment Door" on page 15.
- 8 Replace the battery pack. See "Replacing the Battery Pack" on page 13.
- 9 Follow the instructions in "After Working Inside Your Computer" on page 11.



WARNING: Before working inside your computer, read the safety information that shipped with your computer and follow the steps in "Before You Begin" on page 9. For additional safety best practices information, see the Regulatory Compliance Homepage at dell.com/regulatory_compliance.

Prerequisites

- 1 Remove the battery pack. See "Removing the Battery Pack" on page 12.
- 2 Remove the compartment door. See "Removing the Compartment Door" on page 14.
- 3 Remove the center control cover. See "Removing the Center Control Cover" on page 41.
- 4 Remove the keyboard. See "Removing the Keyboard" on page 45.
- 5 Remove the power button board. See "Removing the Power Button Board" on page 55.
- 6 Remove the display assembly. See "Removing the Display Assembly" on page 57.
- 7 Remove the status light board. See "Removing the Status Light Board" on page 61.
- 8 Remove the palm rest assembly. See "Removing the Palm Rest Assembly" on page 64.

Procedure

- 1 Disconnect the speakers cable from the connector on the system board.
- 2 Note the speakers cable routing and remove the cable from the routing guides on the computer base.
- 3 Remove the screws that secure the speakers to the computer base.
- 4 Lift the speakers along with the cable off the computer base.

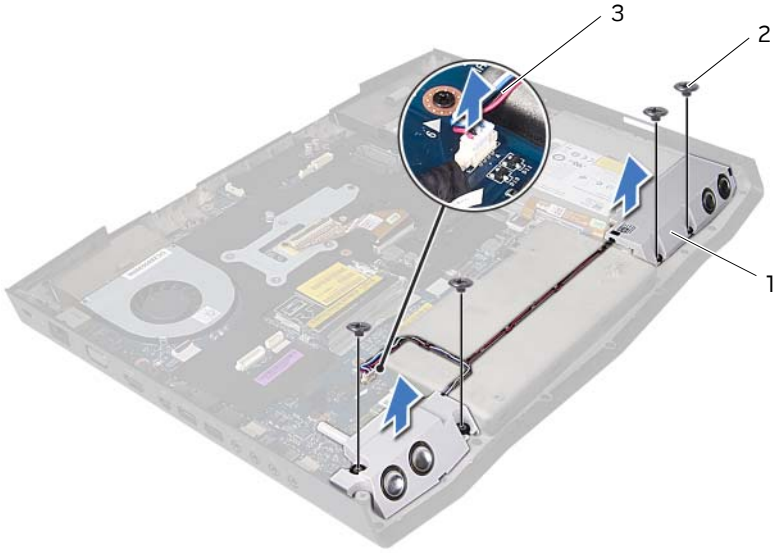

-
- 1 speakers (2)
 - 3 speakers cable

-
- 2 screws (4)



WARNING: Before working inside your computer, read the safety information that shipped with your computer and follow the steps in "Before You Begin" on page 9. For additional safety best practices information, see the Regulatory Compliance Homepage at dell.com/regulatory_compliance.

Procedure

- 1 Align the screw holes on the speakers with the screw holes on the computer base.
- 2 Replace the screws that secure the speakers to the computer base.
- 3 Route the speakers cable through the routing guides on the computer base.
- 4 Connect the speakers cable to the connector on the system board.

Postrequisites

- 1 Replace the palm rest assembly. See "Replacing the Palm Rest Assembly" on page 66.
- 2 Replace the status light board. See "Replacing the Status Light Board" on page 63.
- 3 Replace the display assembly. See "Replacing the Display Assembly" on page 60.
- 4 Replace the power button board. See "Replacing the Power Button Board" on page 56.
- 5 Replace the keyboard. See "Replacing the Keyboard" on page 48.
- 6 Replace the center control cover. See "Replacing the Center Control Cover" on page 44.
- 7 Replace the compartment door. See "Replacing the Compartment Door" on page 15.
- 8 Replace the battery pack. See "Replacing the Battery Pack" on page 13.
- 9 Follow the instructions in "After Working Inside Your Computer" on page 11.

 **WARNING:** Before working inside your computer, read the safety information that shipped with your computer and follow the steps in "Before You Begin" on page 9. For additional safety best practices information, see the Regulatory Compliance Homepage at dell.com/regulatory_compliance.

Prerequisites

- 1 Remove the battery pack. See "Removing the Battery Pack" on page 12.
- 2 Remove the compartment door. See "Removing the Compartment Door" on page 14.
- 3 Remove the center control cover. See "Removing the Center Control Cover" on page 41.
- 4 Remove the keyboard. See "Removing the Keyboard" on page 45.
- 5 Remove the power button board. See "Removing the Power Button Board" on page 55.
- 6 Remove the display assembly. See "Removing the Display Assembly" on page 57.
- 7 Remove the status light board. See "Removing the Status Light Board" on page 61.
- 8 Remove the palm rest assembly. See "Removing the Palm Rest Assembly" on page 64.
- 9 Remove the speakers. See "Removing the Speakers" on page 70.

Procedure

- 1 Lift the release latch on the connector on the system board and disconnect the optical-drive cable from the connector on the system board.
- 2 Remove the screws that secure the optical-drive assembly to the computer base.
- 3 Lift the optical-drive assembly off the computer base.

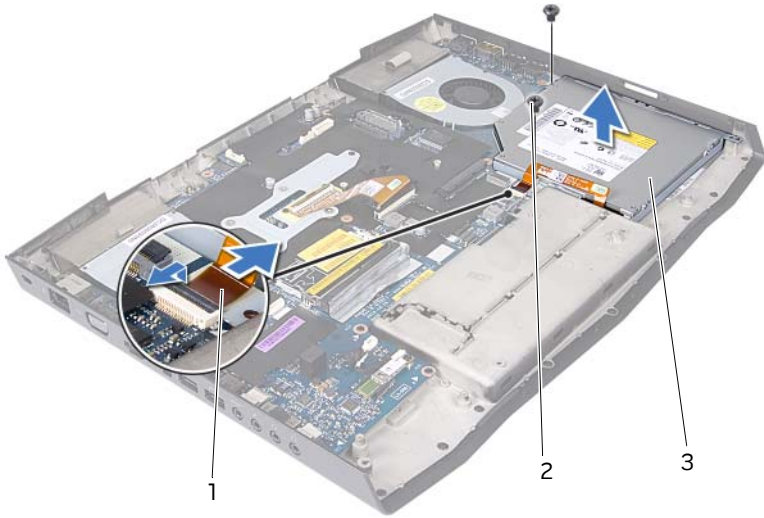

1	optical-drive cable	2	screws (2)
3	optical drive		

4 Remove the screws that secure the optical-drive bracket to the optical drive.

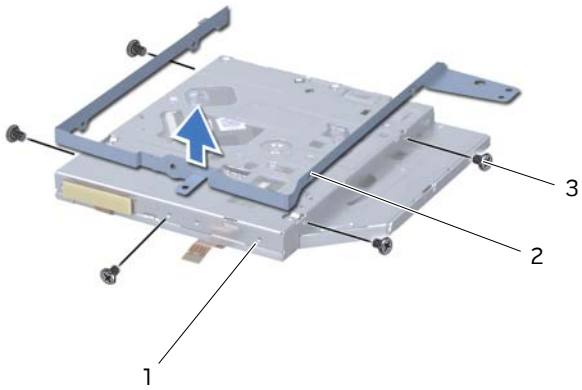

1	optical drive	2	optical-drive bracket
3	screws (5)		

5 Disconnect the interposer from the optical drive.

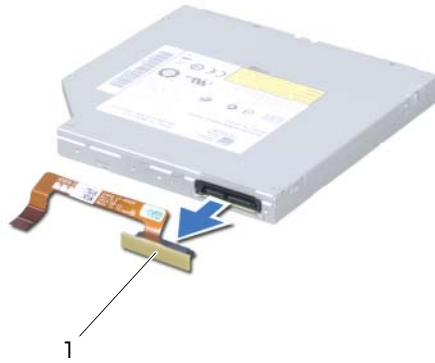

1 interposer

 **WARNING:** Before working inside your computer, read the safety information that shipped with your computer and follow the steps in "Before You Begin" on page 9. For additional safety best practices information, see the Regulatory Compliance Homepage at dell.com/regulatory_compliance.

Procedure

- 1 Connect the interposer to the optical drive.
- 2 Align the screw holes on the optical-drive bracket with the screw holes on the optical drive and replace the screws that secure the optical-drive bracket to the optical drive.
- 3 Align the slot on the optical-drive bracket with the alignment posts on computer chassis and secure the optical-drive assembly in place.
- 4 Replace the screws that secure the optical-drive assembly to the computer base.
- 5 Slide the optical drive cable into the connector on the system board and press down on the connector latch to secure the cable.

Postrequisites

- 1 Replace the speakers. See "Replacing the Speakers" on page 72.
- 2 Replace the palm rest assembly. See "Replacing the Palm Rest Assembly" on page 66.
- 3 Replace the status light board. See "Replacing the Status Light Board" on page 63.
- 4 Replace the display assembly. See "Replacing the Display Assembly" on page 60.
- 5 Replace the power button board. See "Replacing the Power Button Board" on page 56.
- 6 Replace the keyboard. See "Replacing the Keyboard" on page 48.
- 7 Replace the center control cover. See "Replacing the Center Control Cover" on page 44.
- 8 Replace the compartment door. See "Replacing the Compartment Door" on page 15.
- 9 Replace the battery pack. See "Replacing the Battery Pack" on page 13.
- 10 Follow the instructions in "After Working Inside Your Computer" on page 11.

 **WARNING:** Before working inside your computer, read the safety information that shipped with your computer and follow the steps in "Before You Begin" on page 9. For additional safety best practices information, see the Regulatory Compliance Homepage at dell.com/regulatory_compliance.

 **CAUTION:** Handle components by their edges, and avoid touching pins and contacts.

The system board's BIOS chip contains the Service Tag, which is also visible on a barcode label at the bottom of the computer.

Prerequisites

- 1 Remove any installed card or blank from the 9-in-1 Media Card Reader.
- 2 Remove the battery pack. See "Removing the Battery Pack" on page 12.
- 3 Remove the compartment door. See "Removing the Compartment Door" on page 14.
- 4 Remove the hard drive(s). See "Removing the Hard Drive(s)" on page 18.
- 5 Remove the coin-cell battery. See "Removing the Coin-Cell Battery" on page 16.
- 6 Remove the memory module(s). See "Removing the Memory Module(s)" on page 22.
- 7 Remove the graphics-card heat sink fan. See "Removing the Graphics-Card Heat Sink Fan" on page 26.
- 8 Remove the graphics-card assembly. See "Removing the Graphics-Card Assembly" on page 32.
- 9 Remove the processor heat-sink fan. See "Removing the Processor Heat-Sink Fan" on page 29.
- 10 Remove the processor heat-sink. See "Removing the Processor Heat-Sink" on page 35.
- 11 Remove the processor module. See "Removing the Processor Module" on page 38.
- 12 Remove the center control cover. See "Removing the Center Control Cover" on page 41.
- 13 Remove the keyboard. See "Removing the Keyboard" on page 45.
- 14 Remove the Mini-Card. See "Removing the Mini-Card" on page 49.
- 15 Remove the power button board. See "Removing the Power Button Board" on page 55.
- 16 Remove the display assembly. See "Removing the Display Assembly" on page 57.
- 17 Remove the wirelessHD card. See "Removing the WirelessHD Card" on page 53.
- 18 Remove the status light board. See "Removing the Status Light Board" on page 61.

- 19 Remove the palm rest assembly. See "Removing the Palm Rest Assembly" on page 64.
- 20 Remove the Bluetooth card. See "Removing the Bluetooth Card" on page 67.
- 21 Remove the speakers. See "Removing the Speakers" on page 70.
- 22 Follow the instructions from step 1 to step 3 in "Removing the Optical Drive" on page 73.

Procedure

- 1 Remove the screws that secure the system board to the computer base.
- 2 Carefully ease the connectors on the system board out of the slots in the computer, and lift the system board off the computer base.



1	screws (6)	2	system board
---	------------	---	--------------

 **WARNING:** Before working inside your computer, read the safety information that shipped with your computer and follow the steps in "Before You Begin" on page 9. For additional safety best practices information, see the Regulatory Compliance Homepage at dell.com/regulatory_compliance.

 **CAUTION:** Handle components by their edges, and avoid touching pins and contacts.

Procedure

- 1 Align the connectors on the system board with the slots on the computer base and place it on the computer base.
- 2 Replace the screws that secure the system board to the computer base.

Postrequisites

- 1 Follow the instructions from step 3 to step 5 in "Replacing the Optical Drive" on page 76.
- 2 Replace the speakers. See "Replacing the Speakers" on page 72.
- 3 Replace the Bluetooth card. See "Replacing the Bluetooth Card" on page 69.
- 4 Replace the palm rest assembly. See "Replacing the Palm Rest Assembly" on page 66.
- 5 Replace the status light board. See "Replacing the Status Light Board" on page 63.
- 6 Replace the wirelessHD card. See "Replacing the WirelessHD Card" on page 54.
- 7 Replace the display assembly. See "Replacing the Display Assembly" on page 60.
- 8 Replace the power button board. See "Replacing the Power Button Board" on page 56.
- 9 Replace the Mini-Card. See "Replacing the Mini-Card" on page 51.
- 10 Replace the memory module(s). See "Replacing the Memory Module(s)" on page 24.
- 11 Replace the keyboard. See "Replacing the Keyboard" on page 48.
- 12 Replace the center control cover. See "Replacing the Center Control Cover" on page 44.
- 13 Replace the processor module. See "Replacing the Processor Module" on page 40.
- 14 Replace the processor heat-sink. See "Replacing the Processor Heat-Sink" on page 37.
- 15 Replace the processor heat-sink fan. See "Replacing the Processor Heat-Sink Fan" on page 31.
- 16 Replace the graphics-card assembly. See "Replacing the Graphics-Card Assembly" on page 34.

- 17 Replace the graphics-card heat sink fan. See "Replacing the Graphics-Card Heat Sink Fan" on page 28.
 - 18 Replace the coin-cell battery. See "Replacing the Coin-Cell Battery" on page 17.
 - 19 Replace the hard drive(s). See "Replacing the Hard Drive(s)" on page 21.
 - 20 Replace the compartment door. See "Replacing the Compartment Door" on page 15.
 - 21 Replace the battery pack. See "Replacing the Battery Pack" on page 13.
 - 22 Replace any cards or blank that you removed from the 9-in-1 Media Card Reader.
 - 23 Follow the instructions in "After Working Inside Your Computer" on page 11.
 - 24 Turn on the computer.
-  **NOTE:** After you have replaced the system board, enter the computer Service Tag into the BIOS of the replacement system board.
- 25 Enter the service tag. See "Entering the Service Tag in the BIOS" on page 80.

Entering the Service Tag in the BIOS

- 1 Ensure that the AC adapter is plugged in and that the main battery is installed properly.
- 2 Turn on the computer.
- 3 Press <F2> during POST to enter the system setup program.
- 4 Navigate to the security tab and enter the service tag in the **Set Service Tag** field.

Configuring the System Setup

The System Setup options allow you to:

- Change the system configuration information after you add, change or remove any hardware in your laptop.
- Set or change a user-selectable option.
- View the installed amount of memory or set the type of hard drive installed.

Before you use System Setup, it is recommended that you write down the current System Setup information for future reference.

 **CAUTION: Do not change the settings in System Setup unless you are an expert computer user. Certain changes can cause your computer to work incorrectly.**

Entering System Setup

- 1 Turn on (or restart) your laptop.

 **NOTE:** Keyboard failure may result when a key on the keyboard is held down for extended periods of time. To avoid possible keyboard failure, press and release <F2> in even intervals until the System Setup screen appears.

- 2 While the laptop is booting, press <F2> immediately before the operating system logo appears to access the BIOS Setup Utility. If an error occurs during POST (Power On Self Test), you may also enter the BIOS Setup Utility by pressing <F2> when prompted.

 **NOTE:** If you wait too long and the operating system logo appears, continue to wait until you see the Microsoft Windows desktop, then shut down your laptop and try again.

System Setup Screens

The BIOS Setup Utility window displays current or changeable configuration information for your laptop. Information is divided into five menus: Main, **Advanced**, **Security**, Boot, and Exit.

Key functions appear at the bottom of the BIOS Setup Utility window and lists keys and their functions within the active field.

System Setup Options



NOTE: Depending on your computer and installed devices, the items listed in this section may not appear, or may not appear exactly as listed.

Main Menu

System Time (hh:mm:ss)	Displays the system time.
System Date (mm/dd/yyyy)	Displays the system date.
Alienware	Displays the model number of your computer.
Service Tag	Displays the Service Tag of your computer.
BIOS Version	Displays the BIOS version.
EC Version	Displays the EC firmware version.
ME version	Displays the Intel ME firmware version.
CPU	Displays the type of processor installed.
CPU Frequency	Displays the speed of the processor.
CPU L3 Cache	Displays the processor cache size.
CPUID	Displays the ID of the processor.
Integrated Graphics	Displays the integrated graphics.
Discrete Graphics	Displays the discrete graphics.
Total Memory	Displays the total memory available in your computer.
Memory Bank 0	Displays the memory size installed in DIMM 0.
Memory Bank 1	Displays the memory size installed in DIMM 1.
Memory Bank 2	Displays the memory size installed in DIMM 2.
Memory Bank 3	Displays the memory size installed in DIMM 3.

Advanced Menu

Intel SpeedStep	Allows you to enable or disable the Intel SpeedStep technology. Disabling this feature may improve performance, but will greatly reduce battery life.
Virtualization	Allows you to enable or disable the Intel Virtualization technology.
USB Emulation	Allows you to enable or disable the USB emulation feature. This feature defines how the BIOS, in the absence of a USB-aware operating system, handles USB devices. USB emulation is always enabled during POST. NOTE: You cannot boot any type of USB device (floppy, hard drive, or memory key) when this option is off.
USB Wake Support	Allows you to enable USB devices to wake the computer from standby or to disable the USB wake support feature. NOTE: If USB Powershare is enabled, a device connected to the USB Powershare connector may not wake the computer.
USB Power Share	Allows you to charge USB devices when the computer is turned off or in standby mode. <ul style="list-style-type: none"> ▪ AC Only: Charge USB devices when connected to AC adapter only. ▪ AC and Battery: Charge USB devices when connected to AC adapter and when the computer is running on battery. ▪ Disabled: Disables USB PowerShare.
Integrated Network	Allows you to enable or disable the on-board LAN controller. <ul style="list-style-type: none"> ▪ Disabled: Internal LAN is disabled and is not visible to the operating system. ▪ Enabled: Internal LAN is enabled.

High Definition Audio	<p>Allows you to enable or disable the internal high definition audio device.</p> <ul style="list-style-type: none"> ▪ Disabled: The internal audio device is disabled and is not visible to the operating system. ▪ Enabled: The internal audio device is enabled.
SD Card Reader	<p>Allows you to enable or disable the internal SD card reader.</p>
CPU Turbo Mode	<p>Allows you to enable or disable the Intel CPU turbo mode performance option.</p>
Performance Options	<p>Allows you to configure fields in the Performance Options sub-menu. For more information, see "Advanced Menu—Performance Options" on page 85.</p>
SATA Operation	<p>Allows you to configure the operating mode of the integrated SATA hard drive controller.</p> <ul style="list-style-type: none"> ▪ AHCI: SATA is configured for AHCI mode. ▪ RAID: SATA is configured for RAID mode.
SATA HARD DRIVE 1	<p>Displays the installed primary SATA hard drive model.</p>
SATA HARD DRIVE 2	<p>Displays the installed secondary SATA hard drive model.</p>
Adapter Warnings	<ul style="list-style-type: none"> ▪ Allows you to choose if the computer should display warning messages when you use AC adapters that are not supported by your computer. ▪ Enabled: BIOS will detect unsupported AC adapters and display an error on the screen.
Charger Behavior	<p>Allows you to enable or disable battery charging.</p>

Advanced Menu—Performance
Options

Overclocking Feature	Allows you to enable or disable the global overclocking feature. <ul style="list-style-type: none">▪ Disabled: The overclocking feature is disabled.▪ Enabled: Displays additional overclocking options.
Override Turbo settings	Allows you to override CPU turbo mode settings.
Long Duration PWR Limit	Allows you to set the turbo mode power limit 1 value in watts.
Long Duration Time Window	Allows you to set the turbo mode time 1 value in seconds.
Set Short Duration PWR Limit	Allows you to enable or disable short duration power limit.
Set Duration Limit	Allows you to set the turbo mode power limit 2 values in watts.
Bus Clock	
Current Frequency	Displays the current bus clock frequency.
New Frequency in 10KHz increments	Allows you to set the bus clock frequency in increments of 10KHz.
Apply New Bus Clock Frequency	Applies the new bus clock frequency immediately, temporarily, or permanently.
Memory Overclocking	
Memory Override Support	Allows you to enable or disable the memory override option support. <ul style="list-style-type: none">▪ Disabled: The memory override support is disabled.▪ Enabled: Displays additional memory override support options.
Memory Voltage	Allows you to increase memory voltage.
Memory Frequency	Allows you to set memory frequency.
DIMM Profile (XMP)	Allows you to configure different XMP options.

Wireless Menu

Bluetooth	Allows you to enable or disable the internal Bluetooth device. <ul style="list-style-type: none">▪ Disabled: The internal Bluetooth device is disabled and is not visible to the operating system.▪ Enabled: The internal Bluetooth device is enabled.
Wireless Network	Allows you to enable or disable the internal wireless device. <ul style="list-style-type: none">▪ Disabled: The internal wireless device is disabled and is not visible to the operating system.▪ Enabled: The internal wireless device is enabled.
DMC	Allows you to enable or disable the internal DMC device.
Wireless Switch/Hotkey	Allows you to disable all internal wireless devices.

Security Menu

Supervisor Password	Displays if the supervisor password is clear or set.
User Password	Displays if the user password is clear or set.
Set Service Tag	Displays the Service Tag of the computer when the Service Tag is present. Displays a field to input the Service Tag manually when the Service Tag is absent.
Set Supervisor Password	Allows you to set the supervisor password. The supervisor password controls access to the system setup utility.
Set User Password	Allows you to set the user password. The user password controls access to the computer at boot.
Computrace	Allows you to enable or disable Computrace security feature.

Boot Menu

Use the up- or down- arrow keys to change the boot device priority. You can choose from:

- Hard Drive
- USB Storage
- CD/DVD/BD
- Removal Devices
- Network

Exit Menu

Exit Saving Changes	Allows you to exit System Setup and save your changes to CMOS.
Save Change Without Exit	Allows you to remain in System Setup and save your changes to CMOS.
Exit Discarding Changes	Allows you to exit System Setup and load previous values from CMOS for all Setup items.
Load Optimal Defaults	Allows you to load default values for all Setup items.
Discard Changes	Allows you to load previous values from CMOS for all Setup items.

The BIOS may require flashing when an update is available or when replacing the system board. To flash the BIOS:

- 1 Turn on the computer.
- 2 Go to **support.dell.com/support/downloads**.
- 3 Locate the BIOS update file for your computer:

 **NOTE:** The Service Tag for your computer is located on a label at the back of your computer. For more information, see the Quick Start Guide that shipped with your computer.

If you have your computer's Service Tag or Express Service Code:

- a Enter your computer's Service Tag or Express Service Code in the **Service Tag or Express Service Code** field.
- b Click **Submit** and proceed to step 4.

If you do not have your computer's Service Tag or Express Service Code:

- a Select one of the following options:
 - **Automatically detect my Service Tag for me**
 - **Choose from My Products and Services List**
 - **Choose from a list of all Dell products**
 - b Click **Continue** and follow the instructions on the screen.
- 4 A list of results appears on the screen. Click **BIOS**.
 - 5 Click Download File to download the latest BIOS file.
 - 6 In the **Please select your download method** below window, click For Single File Download via Browser, and then click Download Now.
 - 7 In the **Save As** window, select an appropriate location to download the file on your computer.
 - 8 If the **Download Complete** window appears, click **Close**.
 - 9 Navigate to the folder where you downloaded the BIOS update file. The file icon appears in the folder and is titled the same as the downloaded BIOS update file.
 - 10 Double-click the BIOS update file icon and follow the instructions that appear on the screen.