

Dell UltraSharp 27 Monitor

User's Guide

Model No. : UP2715K
Regulatory model: UP2715Kt





NOTE: A NOTE indicates important information that helps you make better use of your computer.



CAUTION: A CAUTION indicates potential damage to hardware or loss of data if instructions are not followed.



WARNING: A WARNING indicates a potential for property damage, personal injury, or death.

Information in this document is subject to change without notice.

© 2014-2016 Dell Inc. All rights reserved.

Reproduction of these materials in any manner whatsoever without the written permission of Dell Inc. is strictly forbidden.

Trademarks used in this text: *Dell* and the *DELL* logo are trademarks of Dell Inc.; *Microsoft* and *Windows* are either trademarks or registered trademarks of Microsoft Corporation in the United States and/or other countries, *Intel* is a registered trademark of Intel Corporation in the U.S. and other countries; and *ATI* is a trademark of Advanced Micro Devices, Inc.

Other trademarks and trade names may be used in this document to refer to either the entities claiming the marks and names or their products. Dell Inc. disclaims any proprietary interest in trademarks and trade names other than its own.

Contents

1 About Your Monitor	5
Package Contents	5
Product Features	7
Identifying Parts and Controls	8
Monitor Specifications	12
Plug and Play Capability	20
LCD Monitor Quality and Pixel Policy	20
Maintenance Guidelines	21
2 Setting Up the Monitor	22
Attaching the Stand	22
Connecting Your Monitor	22
Connecting the DP cables	23
Types of DP cables	23
Organizing the Cables	30
Attaching the Cable Cover	30
Removing the Stand	31
Wall Mounting (Optional)	32
3 Operating the Monitor	33
Using the Front Panel Controls	33
Using the On-Screen Display (OSD) Menu	35
Setting the Maximum Resolution	48
Using the Tilt, Swivel, and Vertical Extension	49
Rotating the Monitor	50

4	Troubleshooting	51
	Self-Test	51
	Built-in Diagnostics	52
	Common Problems	53
	Product Specific Problems	56
	Troubleshooting the Card Reader	57
5	Appendix	59
	WARNING: Safety Instructions	59
	FCC Notices (U.S. Only) and Other Regulatory Information	59
	Contact Dell	59
	Setting Up Your Monitor Display	60
	Font Size Adjustment Guide	61
	Procedures for setting up dual monitors in Windows Vista [®] , Windows [®] 7, Windows [®] 8, Windows [®] 8.1 or Windows [®] 10	63

About Your Monitor

Package Contents

Your monitor ships with the components shown below. Ensure that you have received all the components and [Contact Dell](#) if something is missing.

 **NOTE:** Some items may be optional and may not ship with your monitor. Some features or media may not be available in certain countries.

 **NOTE:** To set up with any other display mounting solutions, please refer to the respective mounting solution setup guide for setup instructions.



- Monitor



- Stand

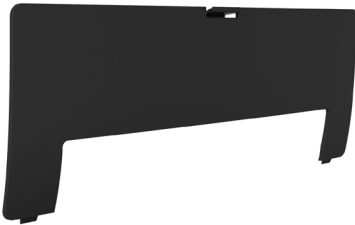

- Cable Cover
-



- Power cable (varies by countries)



- DisplayPort cable (DP to DP)
1 pair



- DisplayPort cable (Mini-DP to DP)
1 pair



- DisplayPort cable (Mini-DP to Mini-DP)



- USB 3.0 upstream cable (enables the USB ports on the monitor)



- Drivers and Documentation media
- Cleaning cloth
- Quick Setup Guide
- Safety and Regulatory Information
- Factory Calibration Report

Product Features

The Dell UltraSharp 27 Monitor (Model # UP2715K) has an active matrix, thinfilm transistor (TFT), liquid crystal display (LCD), and LED backlight. The monitor features include:

- 68.5 cm (27-inch) active area display (measured diagonally) with 5120 x 2880 via Dual DP cable connection, 3840 x 2160 resolution via single DP cable connection, plus full-screen support for lower resolution.
- Wide viewing angle to allow viewing from a sitting or standing position, or while moving from side-to-side.
- Tilt, swivel, pivot and vertical extension adjustment capabilities.
- Built-in speakers (2x 16W) acoustically tuned by Harmon Kardon.
- Removable pedestal and Video Electronics Standards Association (VESA™) 100 mm mounting holes for flexible mounting solutions.
- Plug and play capability if supported by your system.
- On-Screen Display (OSD) adjustments for easy set-up and screen optimization.
- Software and documentation media includes an information file (INF), Image color Matching File (ICM), Dell Display Manager software application and product documentation. Dell Display Manager included (comes in the CD attached with the monitor).
- Security lock slot.
- Asset Management Capability.
- RoHS compliant.
- BFR/PVC Free monitor (excluding cables).
- Arsenic-Free glass and Mercury Free.
- Energy Gauge shows the energy level being consumed by the monitor in real time.
- Meets NFPA 99 leakage current requirements.
- Compatible with Adobe and sRGB color standards.
- Factory calibrated sRGB and Adobe RGB input source (to a delta E of less than 2) for brand new Dell UP2715K monitor. Dedicated Custom Color Mode (6-axis Color-control) for Saturation , Hue, Gain (RGB) and offset (RGB).
- 12-bit internal processing.
- USB 3.0 Card Reader (SD/Mini SD, HSMS/MSPRO, MMC).
- Supports DisplayPort, Mini DisplayPort sources with DP1.2 with HBR2, DisplayID1.3 with Tile feature. (Do not support DP1.1a and older standard.)

Identifying Parts and Controls

Front View



Front view

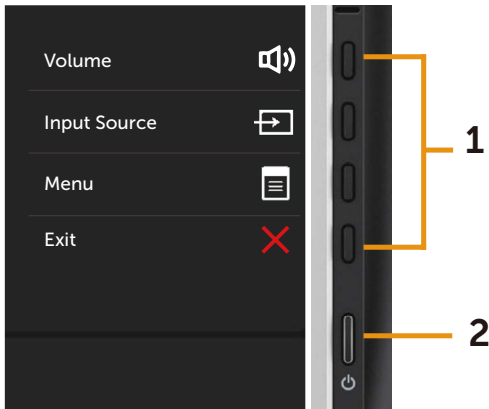

side panel controls

Label	Description
-------	-------------

- | | |
|---|---|
| 1 | Function buttons (For more information, see Operating the Monitor) |
| 2 | Power On/Off button (with LED indicator) |
-

Back View

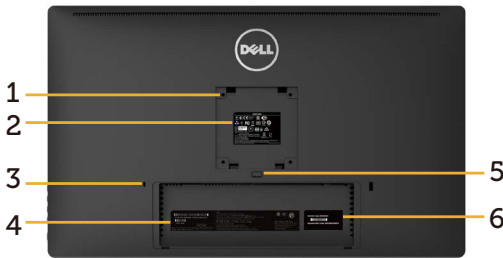

Back view



Back view with monitor stand

Label	Description	Use
1	VESA mounting holes (100 mm x 100 mm - behind attached VESA Cover)	Wall mount monitor using VESA-compatible wall mount kit (100 mm x 100 mm).
2	Regulatory label	Lists the regulatory approvals.
3	Security lock slot	Secures monitor with security cable lock.
4	Barcode serial number label	Refer to this label if you need to contact Dell for technical support.
5	Stand release button	Release stand from monitor.
6	Service tag label	The Dell service tag is used for Dell warranty and customer service management purposes and for records of the base system.
7	USB downstream port with battery charging	Connect your USB device.* You can only use this connector after you have connected the USB cable to the computer and USB upstream connector on the monitor.
8	Cable management slot	Use to organize cables by placing them through the slot.

* It is recommended to use this port for your wireless USB device whenever possible.

Side View

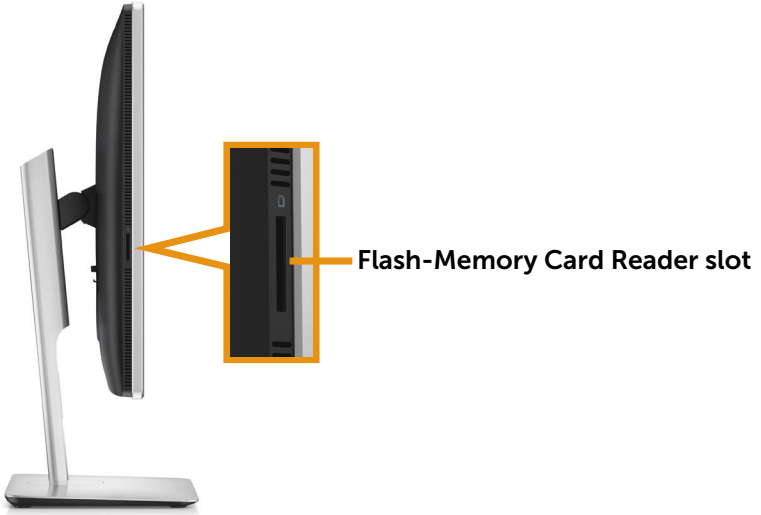

Bottom View

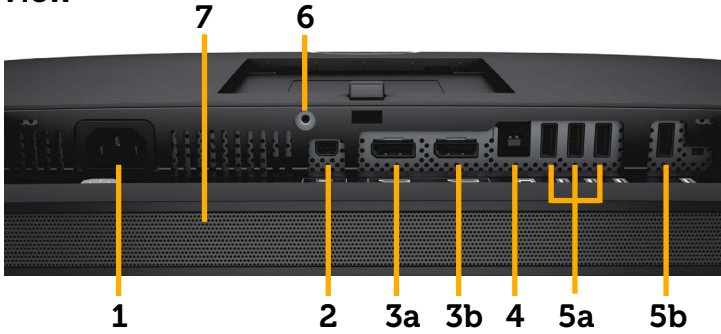

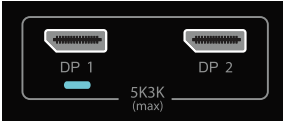
Label	Description	Use
1	AC power connector	To connect the monitor power cord.
2	Mini DisplayPort connector	Connect your computer with: <ul style="list-style-type: none"> • mDP to mDP cable, or • mDP to DP cable for 4K2K (max.) resolution.
		
3a	DisplayPort in connector 1	Connect both connectors to your computer with a pair of: <ul style="list-style-type: none"> • DP to DP cables, or • DP to mDP cables for 5K3K (max.) resolution.
3b	DisplayPort in connector 2	
		
4	USB upstream port	Connect the USB cable that comes with your monitor to the computer. Once this cable is connected, you can use the USB downstream connectors on the monitor.
5a, 5b	USB downstream ports	Connect your USB devices. * You can only use these connectors after you have connected the USB cable to the computer and USB upstream connector on the monitor.
6	Stand lock feature	To lock the stand to the monitor using a M3 x 6mm screw (screw not included).
7	Built-in speakers	To output the sound from audio input.

* It is recommended to use either the port (5b) or the USB downstream port on the rear side for your wireless USB device whenever possible.

Monitor Specifications

Flat panel Specifications

Screen type	Active matrix - TFT LCD
Panel type	In Plane Switching
Viewable image dimensions	
Diagonal	68.5 cm (27-inches viewable image size)
Horizontal	596.74 mm (23.49 inches)
Vertical	335.66 mm (13.22 inches)
Pixel pitch	0.116mm (218 ppi)
Viewing angle	178° (vertical) typ, 178° (horizontal) typ
Luminance output	300 cd/m ² (typ), 50 cd/m ² (min)
Contrast ratio	1000:1 (typ)
Faceplate coating	Edge to edge glass optical bonding with Anti-reflective and Anti-smudge coating
Backlight	LED edge light system
Response Time	8 ms gtg typical
Color depth	1.07 Billion (True 10 bit)
Color gamut (Typical)	100% (sRGB) 99% (Adobe RGB) coverage

Resolution Specifications

Horizontal scan range	31 kHz to 180 kHz
Vertical scan range	30Hz and 60Hz
Maximum resolution	5120 x 2880 at 60Hz DP1.2*

Video Supported Modes

Video display capabilities (DP playback)	480p, 576p, 720p and 1080p
--	----------------------------

Preset Display Modes

Display Mode	Horizontal Frequency (kHz)	Vertical Frequency (Hz)	Pixel Clock (MHz)
640 x 480	31.5	60.0	25.2
800 x 600	37.9	60.0	40.0
1024 x 768	48.4	60.0	65.0
1280 x 800	49.3	60.0	71.0
1280 x 1024	64.0	60.0	108.0
1600 x 1200	75.0	60.0	148.5

1920 x 1080	67.5	60.0	193.5
2560 x 1440	88.8	60.0	241.5
3840 x 2160	133.3	60.0	297.0
5120 x 2880*	85.6	30.0	238.3
5120 x 2880*	177.7	60.0	483.3

* To display 5120 x 2880 at 60 Hz and 30 Hz, both DP1 and DP2 must be connected. DP source's graphics card must be DP1.2 certified and Tile display feature, capable of supporting resolution up to 5120 x 2880 at 60Hz and its driver supports DisplayID v1.3.

Electrical Specifications

Video input signals	Digital video signal for each differential line, predifferential line at 100 ohm impedance. DP1.2 signal input support
AC input voltage/ frequency/current	100 to 240 VAC/50 or 60 Hz \pm 3 Hz/2.4 A (Max.)
Inrush current	120 V:40 A (Max.) 240 V:80 A (Max.)

Speaker Specifications

Speaker rated power	2 x 16 W
Frequency Response	200 Hz - 20 kHz
Impedance	4 ohm

Physical Characteristics

Connector type	DisplayPort connector. Mini DisplayPort connector. USB 3.0 update stream port connector. USB 3.0 down stream port connector x 5. (Port with  lightning icon is for BC 1.2)
Signal cable type	<ul style="list-style-type: none"> Digital: detachable, DisplayPort to Mini DisplayPort 1.8 M cable. Digital: detachable, DisplayPort to DisplayPort 1.8 M cable. Digital: detachable, Mini DisplayPort to Mini DisplayPort 1.8 M cable. Digital: detachable, USB 3.0 1.8 M cable.
Dimensions (with stand)	
Height (extended)	542.1 mm (21.3 inches)

Height (compressed)	427.6 mm (16.8 inches)
Width	637.3 mm (25.1 inches)
Depth	204.5 mm (8.1 inches)
Dimensions (without stand)	
Height	384.6 mm (15.1 inches)
Width	637.3 mm (25.1 inches)
Depth	47.9 mm (1.9 inches)
Stand dimensions	
Height (extended)	420.5 mm (16.6 inches)
Height (compressed)	380.6 mm (15.0 inches)
Width	265.0 mm (10.4 inches)
Depth	204.5 mm (8.1 inches)
Weight	
Weight with packaging	14.30 kg (31.46 lb)
Weight with stand assembly and cables	10.28 kg (22.62 lb)
Weight without stand assembly (For wall mount or VESA mount considerations - no cables)	7.35 kg (16.17 lb)
Weight of stand assembly	2.24 kg (4.93 lb)

Reflection Characteristics

Front frame gloss	45.0 gloss unit (60°) (max.) (User should consider the placement of the display as the front frame may cause disturbing reflections from surrounding light and bright surfaces)
Reflectance	1.5% (typ.)

Environmental Characteristics

Temperature	
Operating	0 °C to 35 °C
Non-operating	Storage: -20 °C to 65 °C (-4 °F to 140 °F) Shipping: -20 °C to 65 °C (-4 °F to 140 °F)
Humidity	
Operating	10% to 80% (non-condensing)
Non-operating	Storage: 5% to 90% (non-condensing) Shipping: 5% to 90% (non-condensing)

Altitude

Operating	5,000 m (16,404 ft) max
Non-operating	12,191 m (40,000 ft) max
Thermal dissipation	580.21 BTU/hour (maximum) 341.30 BTU/hour (typical)

Power Management Modes

If you have VESA's DPM™ compliance display card or software installed in your PC, the monitor can automatically reduce its power consumption when not in use. This is referred to as Power Save Mode*. If the computer detects input from keyboard, mouse, or other input devices, the monitor automatically resumes functioning. The following table shows the power consumption and signaling of this automatic power saving feature:

VESA Modes	Horizontal Sync	Vertical Sync	Video	Power Indicator	Power Consumption
Normal operation	Active	Active	Active	White	100 W (typical)/ 170 W (maximum)
Active-Off mode	Inactive	Inactive	Off	Glowing White	Less than 0.5 W Less than 1.2 W (with USB Hub)
Switch Off	-	-	-	Off	Less than 0.5 W



NOTE: The monitor will achieve the stated Active-Off power approximately 1 minute after it has entered into Active-Off mode.

The OSD will only function in the normal operation mode. When any button is pressed in Active-Off mode, the following message will be displayed:

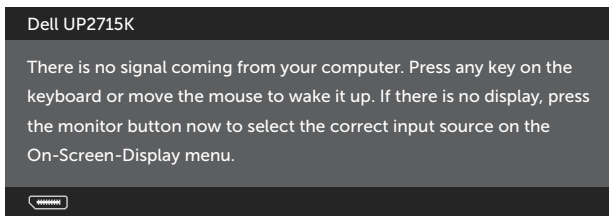

Activate the computer and the monitor to gain access to the OSD.



NOTE: Zero power consumption in OFF mode can only be achieved by disconnecting the main cable from the monitor.

Pin Assignments

DisplayPort Connector (DP in and DP out)

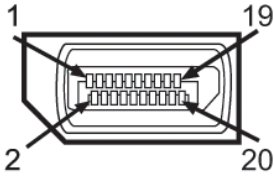

Pin Number	20-pin Side of the monitor connector	Pin Number	20-pin Side of the monitor connector
1	ML0(p)	11	GND
2	GND	12	ML3(n)
3	ML0(n)	13	GND
4	ML1(p)	14	GND
5	GND	15	AUX(p)
6	ML1(n)	16	GND
7	ML2(p)	17	AUX(n)
8	GND	18	HPD
9	ML2(n)	19	DP_PWR Return
10	ML3(p)	20	+3.3 V DP_PWR

Mini DisplayPort Connector

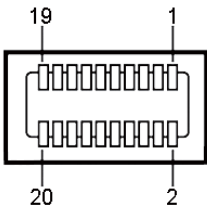



Pin Number	20-pin Side of the monitor connector	Pin Number	20-pin Side of the monitor connector
1	GND	11	ML2(p)
2	Hot Plug Detect	12	ML0(p)
3	ML3(n)	13	GND
4	GND	14	GND
5	ML3(n)	15	ML1(n)
6	GND	16	AUX(p)
7	GND	17	ML1(p)
8	GND	18	AUX(n)
9	ML2(n)	19	GND
10	ML0(p)	20	+3.3 V DP_PWR

Universal Serial Bus (USB) Interface

This section gives you information about the USB ports that are available on the back and bottom of your monitor.

 **NOTE:** The USB ports on this monitor are USB 3.0 compliant.

Transfer speed	Data rate	Power consumption
Super Speed	5 Gbps	4.5 W (Max., each port)
Hi-Speed	480 Mbps	2.5 W (Max., each port)
Full Speed	12 Mbps	2.5 W (Max., each port)

 **NOTE:** Up to 1.5 A on USB downstream port (port  with lightning icon) with BC 1.2 compliance devices; up to 0.9 A on the other 4 USB downstream ports.

USB Upstream Connector

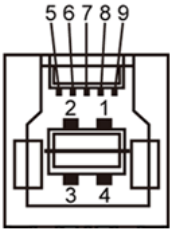

Pin Number	Signal Name
1	VBUS
2	D-
3	D+
4	GND
5	StdB_SSTX-
6	StdB_SSTX+
7	GND_DRAIN
8	StdB_SSRX-
9	StdB_SSRX+
Shell	Shield

USB Downstream Connector

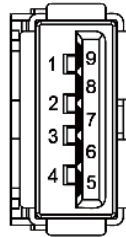



Pin Number	Signal Name
1	VBUS
2	D-
3	D+
4	GND
5	StdA_SSRX-
6	StdA_SSRX+
7	GND_DRAIN
8	StdA_SSTX-
9	StdA_SSTX+
Shell	Shield

USB ports

- 1 upstream - bottom
- 5 downstream - 1 at back, 4 at bottom

Power Charging Port - the one on the rear cover (Port with  lightning icon); supports fast current charging capability if the device is BC 1.2 compatible.

 **NOTE:** USB 3.0 functionality requires a USB 3.0 compatible computer and devices.

 **NOTE:** For computers running Windows® 7 must have Service Pack 1 (SP1) installed. The monitor's USB interface works only when the monitor is On or in Power Save Mode. If you turn Off the monitor and then turn it On, the attached peripherals may take a few seconds to resume normal functionality.

Card Reader Specifications

Overview

- The Flash Memory Card Reader is a USB storage device that allows users to read and write information from and into the memory card.
- The Flash Memory Card Reader is automatically recognized by Microsoft® Windows® Vista, Windows® 7 Service Pack (SP1), Windows® 8, Windows® 8.1 and Windows® 10.
- Once installed and recognized, memory card (slot) appears drive letter.
- All standard file operations (copy, delete, drag-and-drop, etc.) can be performed with this drive.

 **NOTE:** Install the Card Reader driver (provided in the Drivers and Documentation Media CD that comes with the monitor) to ensure memory cards are detected properly when inserted into the card slot.

Features

The Flash Memory Card Reader has the following features:

- Supports Microsoft® Windows® Vista, Windows® 7 Service Pack (SP1), Windows® 8, Windows® 8.1 and Windows® 10 operating systems.
- Mass Storage Class device (No drivers are required under Microsoft® Windows® Vista, Windows® 7 Service Pack (SP1), Windows® 8, Windows® 8.1 and Windows® 10).
- Supports various memory card media.

The following table lists the memory cards supported:

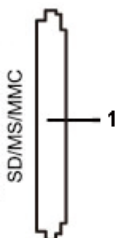
	Slot Number	Flash memory cards type
	1	MS Pro HG, High Speed Memory Stick (HSMS), Memory Stick PRO (MSPRO), Memory Stick Duo (w Adapter), MS Duo Secure Digital (Mini-SD), Secure Digital Card, Mini Secure Digital (w Adaptor), TransFlash (SD, including SDHC), MultiMediaCard (MMC)

Maximum Card Capacity Supported by the UP2715K card reader

Card type	Support Specification	Support Maximum Capacity by Spec.	UP2715K
MS Pro HG	Memory Stick Pro-HG Support USB 3.0 speed	32 GB	Supported
MS Duo	Memory Stick Duo Specification	32 GB	Supported
SD	SD Memory Card support USB 3.0 speed	1 TB	Supported
MMC	Multi Media Card System Specification	32 GB	Supported

General

Connection type	USB 2.0/3.0 High Speed Device (USB High Speed Device compatible)
Supported OS	Microsoft® Windows® Vista, Windows® 7 Service Pack (SP1), Windows® 8, Windows® 8.1 and Windows® 10

Plug and Play Capability

You can install the monitor in any Plug and Play-compatible system. The monitor automatically provides the computer system with its Extended Display Identification Data (EDID) using Display Data Channel (DDC) protocols so that the system can configure itself and optimize the monitor settings. Most monitor installations are automatic; you can select different settings if desired. For more information about changing the monitor settings, see [Operating the Monitor](#).

LCD Monitor Quality and Pixel Policy

During the LCD Monitor manufacturing process, it is not uncommon for one or more pixels to become fixed in an unchanging state which are hard to see and do not affect the display quality or usability. For more information on Dell Monitor Quality and Pixel Policy, see Dell Support site at: <http://www.dell.com/support/monitors>.

Maintenance Guidelines

Cleaning Your Monitor

 **WARNING:** Read and follow the [Safety Instructions](#) before cleaning the monitor.

 **WARNING:** Before cleaning the monitor, unplug the monitor power cable from the electrical outlet.

For best practices, follow the instructions in the list below while unpacking, cleaning, or handling your monitor:

- To clean your antistatic screen, lightly dampen a soft, clean cloth with water. If possible, use a special screen-cleaning tissue or solution suitable for the antistatic coating. Do not use benzene, thinner, ammonia, abrasive cleaners, or compressed air.
- Use a lightly-dampened, warm cloth to clean the monitor. Avoid using detergent of any kind as some detergents leave a milky film on the monitor.
- If you notice white powder when you unpack your monitor, wipe it off with a cloth.
- Handle your monitor with care as dark-colored monitors may scratch and show white scuff marks more than light-colored monitors.
- To help maintain the best image quality on your monitor, use a dynamically changing screen saver and turn Off your monitor when not in use.

Setting Up the Monitor

Attaching the Stand

 **NOTE:** The stand is detached from the monitor when it is shipped from the factory.

 **NOTE:** This stand attaching instruction is applicable for the stand shipped with the monitor. For other mounting solutions (optional), please refer to their respective set up instructions.

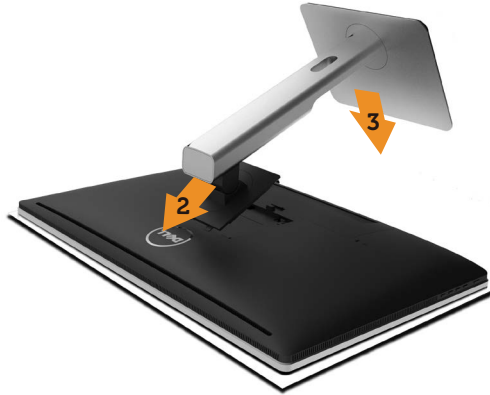

To attach the monitor stand:

1. Remove the monitor protective cover and place the monitor on it.
2. Fit the two tabs on the upper part of the stand to the groove on the back of the monitor.
3. Press the stand down till it snaps into its place.

Connecting Your Monitor

 **WARNING:** Before you begin any of the procedures in this section, follow the [Safety Instructions](#).

To connect your monitor to the computer:

1. Turn off your computer and disconnect the power cable.
2. Connect the DP (DisplayPort) cables to the corresponding video port on the back of your computer

 **NOTE:** Do not use all the cables on the same computer. Use all of the cables only when they are connected to different computers with appropriate video systems.

Connecting the DP cables

Types of DP cables

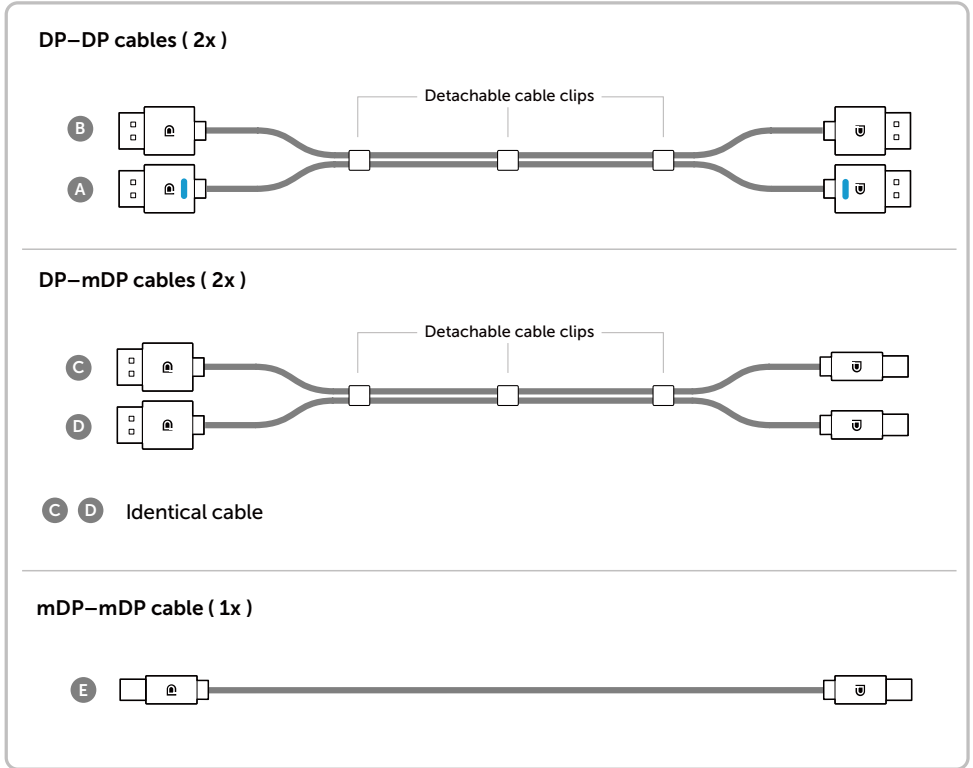

1. Connection Guide for 5K3K (max.) Resolution with Nvidia Graphics Cards (Two DP Cables)

1. Follow the connection guide below for DP cables connection.
2. Turn On the monitor by pressing the power on/off button.
3. Power up/ Boot up the computer system.
4. Change resolution if necessary up to 5120 x 2880 60Hz.



- **Recommended list of cards:**
Quadro series, eg K2200, K4200, K5200.
GeForce series, eg GTX980, GTX970 and GTX960.
- **Graphics card requirement:**
With two DP ports that are compliant to DP1.2 support HBR2, DisplayID 1.3, supporting Tile Display feature.
- **Nvidia driver version:**
rev 347.88 or later
<http://www.nvidia.com/Download/Find.aspx>

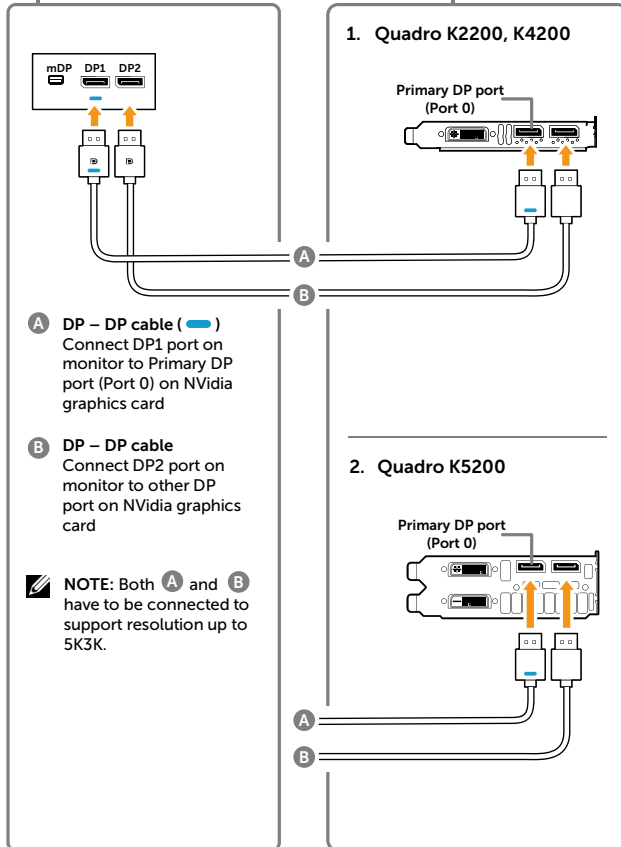

Troubleshooting

1. BIOS/Post screen is not observed, black screen during BIOS/Post, long period of black screen when monitor wake from sleep:

- Ensure the monitor DP 1 is connected to graphics card Port 0 and DP 2 is connected to Port 1. Power off and on the monitor and re- boot the PC system.
- To speed up monitor initialization, disable monitor Sleep by OSD (Menu>Energy Settings>Monitor Sleep> Disable).

2. 5K3K resolution changed after recovery from PC standby/ Hibernate/ Reboot :

- Disable monitor Sleep by OSD (Menu > Energy Settings > Monitor Sleep > Disable).
- Ensure DP 1 and DP 2 are connected to graphics Port0 and Port1 respectively.

3. Cannot achieve or image unstable at 5k3k resolution:

- Perform a clean install by selecting "Custom" and tick box marked "Perform a Clean Install".
- Ensure your graphics card is capable to support 5k3k.
- Use only the in-box DP cables for connection to your PC. Non-DP certified or low quality DP cable may degrade signal integrity/bandwidth, resulting in reduced performance.

2. Connection Guide for 5K3K (max.) Resolution with AMD Graphics Cards (Two DP Cables)

1. Follow the connection guide below for DP cables connection.
2. Turn On the monitor by pressing the power on/off button.
3. Power up/ Boot up the computer system.
4. During BIOS/Post mode, you may observed a stretch screen content.
5. Change resolution if necessary up to 5120 x 2880 60Hz.



- **Recommended list of cards:**
FirePro series eg W9100, W7100, etc.
Radeon series eg R9 295X2, HD7990, etc.
Ensure the graphics card has 2 or more DP outputs.
Refer to AMD website for details.
- **Graphics card requirement:**
With two DP ports that are compliant to DP1.2 support
HBR2, DisplayID 1.3 supporting Tile Display feature.
- **AMD driver version:**
revision later than 14.50 or later
<http://support.amd.com/en-us/download>

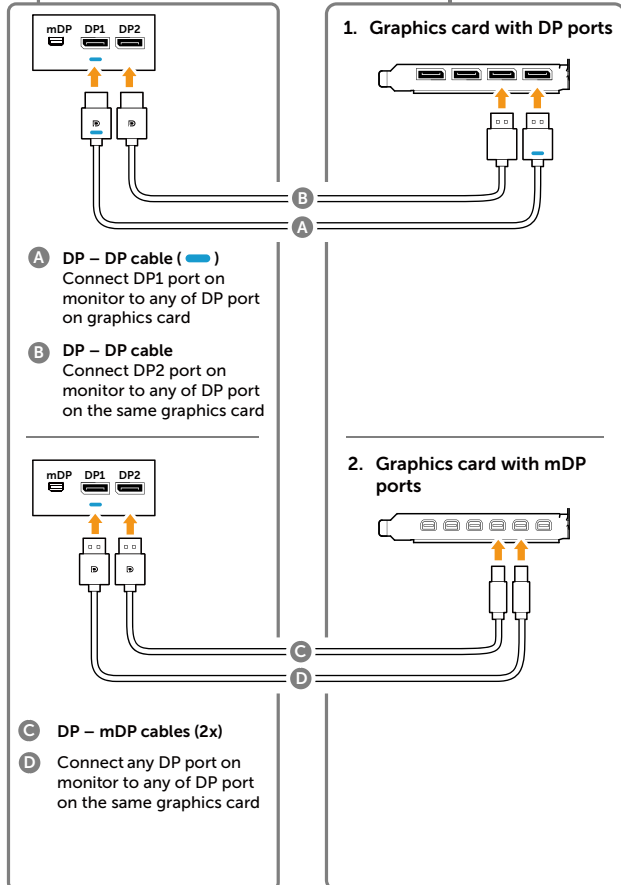

Troubleshooting

- 1. BIOS/Post screen is not observed, black screen during BIOS/Post, long period of black screen when monitor wake from sleep:**
 - To speed up monitor initialization, disable monitor Sleep by OSD (Menu>Energy Settings>Monitor Sleep> Disable).
- 2. 5K3K resolution changed after recovery from PC standby/ Hibernate/ Reboot :**
 - In certain cases, graphics card may not detect the monitor properly when the monitor goes to sleep.
 - Disable monitor Sleep by OSD (Menu > Energy Settings > Monitor Sleep > Disable).
 - Reboot PC.
- 3. Cannot achieve or image unstable at 5k3k resolution:**
 - Un-install the old graphics driver (Device Manager -> Display Adaptor -> uninstall) before installing the new driver.
 - Ensure your graphics card is capable to support 5k3k.
 - Use only the in-box DP cables for connection to your PC. Non-DP certified or low quality DP cable may degrade signal integrity/bandwidth, resulting in reduced performance.
 - Connect only DP1 on the monitor to any DP port of the graphics card. Power up the monitor and PC system. After getting a stable image(eg 4k2k resolution), connect DP2 of monitor to another DP port of the same graphics card.

3. Connection Guide for 5K3K (max.) Resolution with Intel Graphics Cards (Two DP Cables)

1. Follow the connection guide below for DP cables connection.
2. Turn On the monitor by pressing the power on/off button.
3. Power up/ Boot up the computer system.
4. During BIOS/Post mode, you may observed a stretch screen content.
5. Change resolution if necessary up to 5120 x 2880 60Hz.

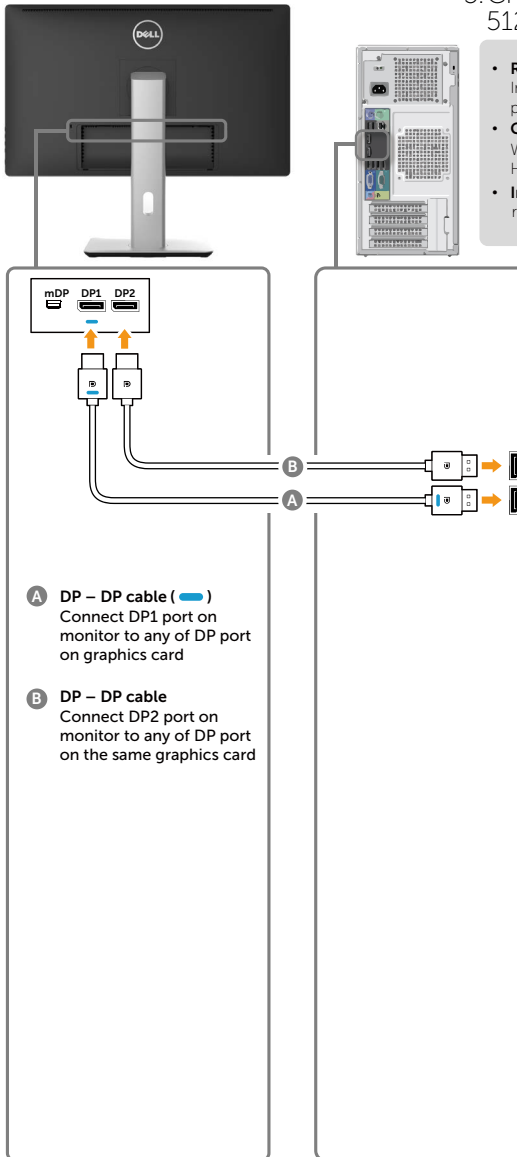

- **Recommended list of cards:**
Intel Broadwell chipset graphics card with 2 DP output ports.
- **Graphics card requirement:**
With two DP ports that are compliant to DP1.2 support HBR2, DisplayID 1.3 supporting Tile Display feature.
- **Intel driver version:**
revision later than 10.18.10.3510

Troubleshooting

1. BIOS/Post screen is not observed, black screen during BIOS/Post, long period of black screen when monitor wake from sleep:

- To speed up monitor initialization, disable monitor Sleep by OSD (Menu>Energy Settings>Monitor Sleep> Disable).

2. Not able to display 5120 x 2880 60Hz :

- Ensure that both DP ports at the source support DP1.2. If the 2 DP ports from the source originates from one single DP1.2 channel it will not have enough bandwidth to support 5K3K 60Hz (e.g. some docking systems).

3. 5K3K resolution changed after recovery from PC standby/ Hibernation/ Reboot : Port1 respectively.

- In certain cases, graphics card may not detect the monitor properly when the monitor goes to sleep.
- Disable monitor Sleep by OSD (Menu > Energy Settings > Monitor Sleep > Disable).
- Reboot PC.

4. Cannot achieve or image unstable at 5k3k resolution:

- Ensure your graphics card is capable to support 5k3k.
- Use only the in-box DP cables for connection to your PC. Non-DP certified or low quality DP cable may degrade signal integrity/bandwidth, resulting in reduced performance.

5. Stretch image observed:

- Ensure that monitor DP2 is connected properly to graphics card.

4. Connection Guide for 4K2K (max.) Resolution (Single DP Cable)

1. Follow the connection guide below for DP cables connection.
2. Turn On the monitor by pressing the power on/off button.
3. Power up/ Boot up the computer or notebook.
4. Change resolution if necessary up to 3860 x 2160 60Hz.

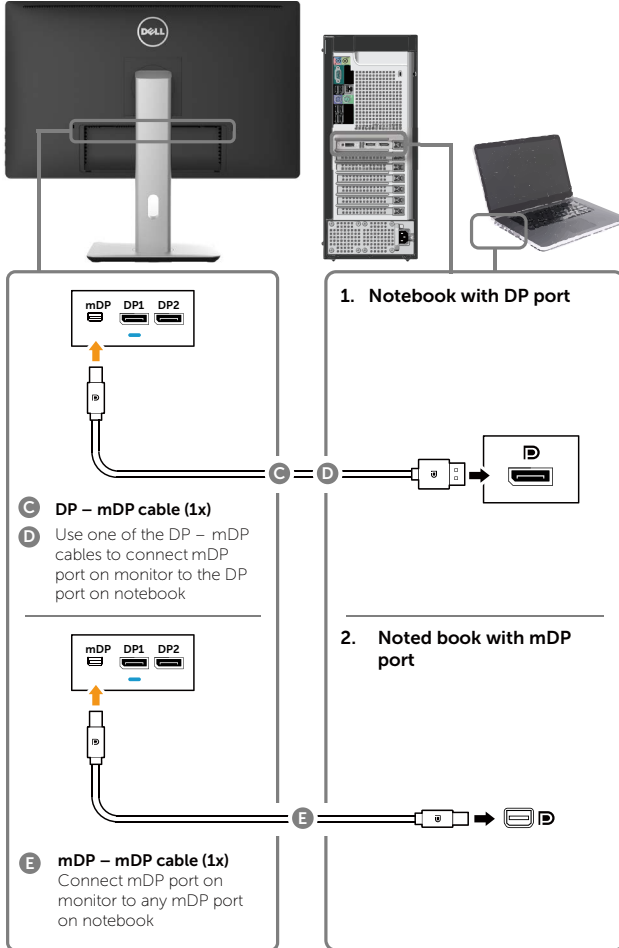

- **Graphics card requirement:**
Single DP port that is compliant to DP1.2 support HBR2.

Troubleshooting

- 1. BIOS/Post screen is not observed, black screen during BIOS/Post, long period of black screen when monitor wake from sleep:**
 - To speed up monitor initialization, disable monitor Sleep by OSD (Menu>Energy Settings>Monitor Sleep> Disable).
- 2. Black screen :**
 - Ensure the graphics card support DP1.2 (older DP version is not supported by UP2715K).
- 3. Cannot achieve or image unstable at 5k3k resolution:**
 - Ensure your graphics card is capable to support 4k2k.
 - Use only the in-box DP cables for connection to your PC. Non-DP certified or low quality DP cable may degrade signal integrity/bandwidth, resulting in reduced performance.

5. Connection Guide for 5K3K 30Hz (max.) Resolution with Docking Station (Two DP cables)

1. Follow the connection guide.
2. Turn on the monitor by pressing the power on/off button
3. Turn on your computer.
4. Change resolution if necessary up to 5120 x 2880 30Hz.

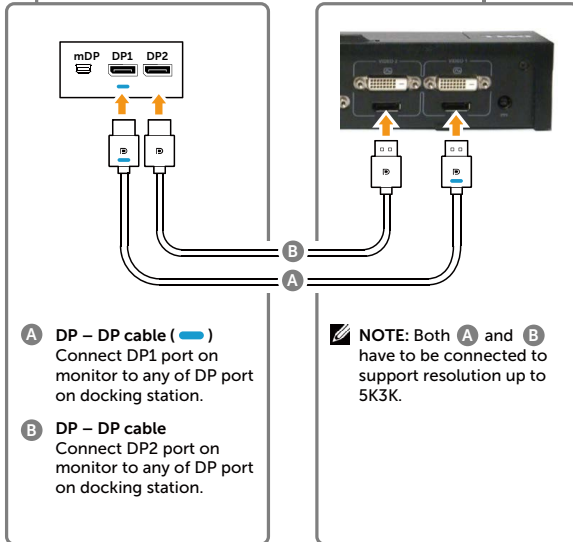

Recommended list of docking stations: Dell E-Port Plus Advanced Port Replicator with USB 3.0

to be docked with Dell notebooks having following internal graphics cards

- a) Nvidia Graphics
KX000 or KX200 series
(driver R344.11 or later)
- b) AMD Graphics
WX100 series
(driver later than R14.501.x)

Example: Dell Precision M4800, M6800.

Troubleshooting

1. BIOS/Post screen is not observed, black screen during BIOS/Post, long period of black screen when monitor wake from sleep:

- To speed up monitor initialization, disable monitor Sleep by OSD (Menu>Energy Settings>Monitor Sleep> Disable).

2. Not able to display 5120 x 2880 60Hz :

- Ensure that both DP ports at the source support DP1.2 HBR2, DisplayID 1.3 tile display feature..
- Dell E-Port Plus Advanced Port Replicator with USB 3.0 docking system can only support up to 5k3k 30Hz.
- 4k2k is not supported in 2-cable DP docking configuration. Connect single DP from the dock "Video 2" DP port to the monitor miniDP port for 4k2k resolution

3. 5K3K resolution changed after recovery from PC standby/ Hibernate/ Reboot :

- In certain cases, graphics card may not detect the monitor properly when the monitor goes to sleep.
- Disable monitor Sleep by OSD (Menu > Energy Settings > Monitor Sleep > Disable).
- Reboot PC.

4. Cannot achieve or image unstable at 5k3k resolution:

- Ensure your graphics card is capable to support 5k3k.
- Use only the in-box DP cables for connection to your PC. Non-DP certified or low quality DP cable may degrade signal integrity/bandwidth, resulting in reduced performance.

5. Stretch image observed:

- Ensure the monitor DP2 port is connected properly to the DP port of the docking station.

Connection Guide for 4K2K 60Hz

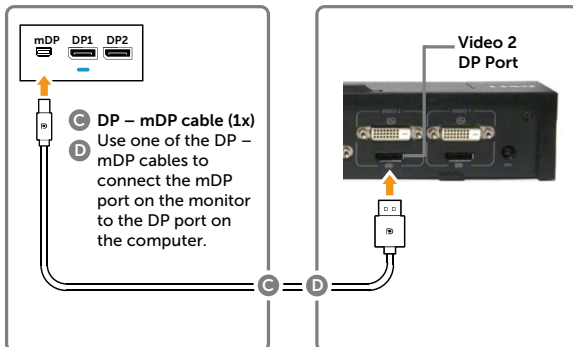

Connecting the USB 3.0 cable

After you have completed connecting the DP-mDP cables, follow the procedure below to connect the USB 3.0 cable to the computer and complete your monitor setup:

1. Connect the upstream USB 3.0 port (cable supplied) to an appropriate USB 3.0 port on your computer.
2. Connect the USB 3.0 peripherals to the downstream USB 3.0 ports on the monitor.
3. Plug the power cables for your computer and monitor into nearby outlet.
4. Turn On the monitor and the computer.

If your monitor displays an image, installation is complete. If it does not display an image, see [Troubleshooting](#).

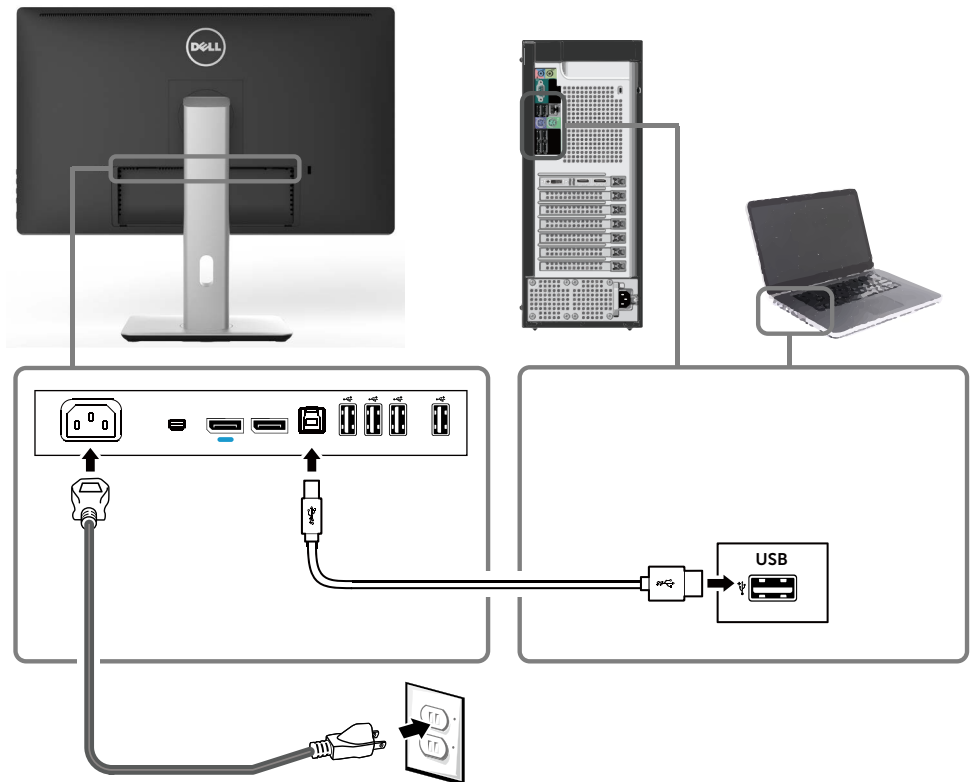

CAUTION: The graphics are used for the purpose of illustration only. Appearance of the computer may vary.

Organizing the Cables



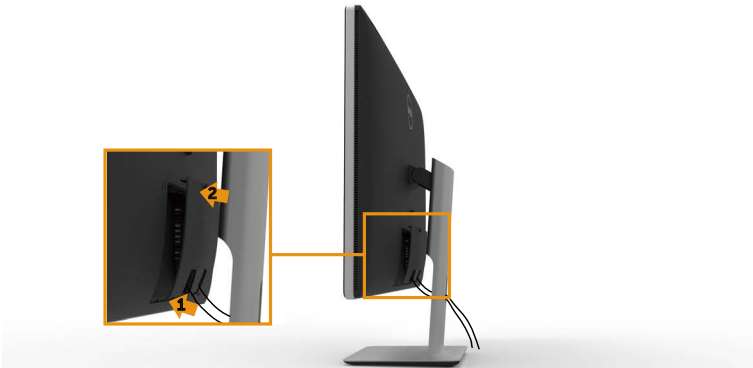

After attaching all necessary cables to your monitor and computer, (See [Connecting Your Monitor](#) for cable attachment,) use the cable management slot to organize all cables as shown above.

Attaching the Cable Cover



Removing the Stand

 **NOTE:** To prevent scratches on the LCD screen while removing the stand, ensure that the monitor is placed on a clean surface.

 **NOTE:** This is applicable for a monitor with a stand. For installation with other mounting solutions (optional), please refer to the respective mounting solution setup guide for set up instructions.



To remove the stand:

1. Place the monitor on a flat surface.
2. Press and hold the stand release button.
3. Lift the stand up and away from the monitor.

Wall Mounting (Optional)



(Screw dimension: M4 x 10 mm).

Refer to the instructions that come with the VESA-compatible wall mounting kit.

1. Place the monitor panel on a soft cloth or cushion on stable flat table.
2. Remove the stand.
3. Use a screwdriver to remove the four screws securing the plastic cover.
4. Attach the mounting bracket from the wall mounting kit to the monitor.
5. Mount the monitor on the wall by following the instructions that came with the wall mounting kit.

 **NOTE:** For use only with UL Listed Wall Mount Bracket with minimum weight/load bearing capacity of 7.14 kg.



Operating the Monitor

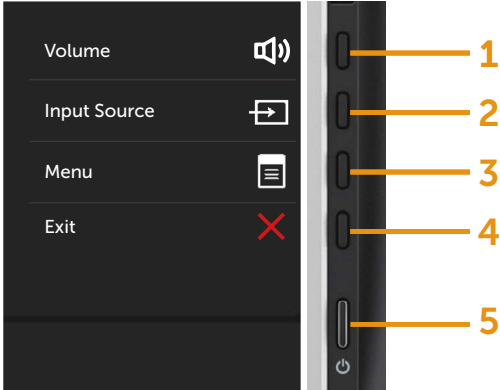

Using the Front Panel Controls

Use the control buttons on the front of the monitor to adjust the characteristics of the image being displayed. As you use these buttons to adjust the controls, an OSD shows the numeric values of the characteristics as they change.







The following table describes the front panel buttons:

Front panel button		Description
1	 Shortcut key/ Volume	Use this button to directly access the Volume menu.
2	 Shortcut key/ Input Source	Use this button to choose from a list of Input Source.

3	 Menu	Use the Menu button to launch the on-screen display (OSD) and select the OSD Menu. See Accessing the Menu System .
4	 Exit	Use the Exit button to go back to the main menu or exit the OSD main menu.
5	 Power (with power light indicator)	Use the Power button to turn the monitor On and Off. The white LED indicates the monitor is On and fully functional. A glowing white LED indicates DPMS Power Save Mode.

Front Panel Button

Use the buttons on the front of the monitor to adjust the image settings.

		Front Panel Button	Description
	1	 Up	Use the Up button to adjust (increase ranges) items in the OSD menu.
	2	 Down	Use the Down button to adjust (decrease ranges) items in the OSD menu.
	3	 OK	Use the OK button to confirm your selection.
	4	 Back	Use the Back button to go back to the previous menu.









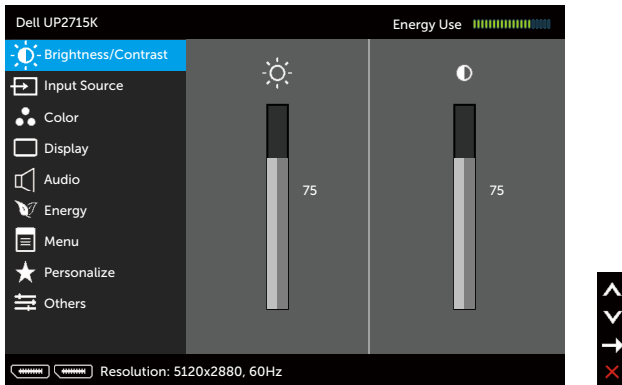

Using the On-Screen Display (OSD) Menu

Accessing the Menu System

 **NOTE:** If you change the settings and then either proceed to another menu or exit the OSD menu, the monitor automatically saves those changes. The changes are also saved if you change the settings and then wait for the OSD menu to disappear.

1. Press the **Menu** button to launch the OSD menu and display the main menu.



2. Press the  and  buttons to move between the setting options. As you move from one icon to another, the option name is highlighted. See the following table for a complete list of all the options available for the monitor.
3. Press the  or  button once to activate the highlighted option.
4. Press the  and  buttons to select the desired parameter.
5. Press the  button to enter the slide bar and then use the  or  button, according to the indicators on the menu, to make your changes.
6. Press the  button once to return to the main menu to select another option or press the  button two or three times to exit from the OSD menu.

Icon	Menu and Submenus	Description
	Energy Use	This meter shows the energy level being consumed by the monitor in real time.



**Brightness/
Contrast**

Use this menu to activate **Brightness/Contrast** adjustment.

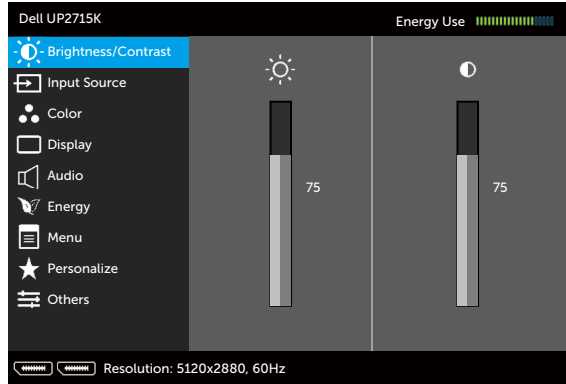

Brightness **Brightness** adjusts the luminance of the backlight.

Press the button to increase brightness and press the button to decrease brightness (min 0 ~ max 100).

NOTE: Manual adjustment of **Brightness** is disabled **Preset Modes** is set to **CAL1** or **CAL2**.

Contrast Adjust **Brightness** first, and then adjust **Contrast** only if further adjustment is necessary.

Press the button to increase contrast and press the button to decrease contrast (min 0 ~ max 100).

The **Contrast** function adjusts the degree of difference between darkness and lightness on the monitor screen.

NOTE: Manual adjustment of **Contrast** is disabled when **Preset Modes** is set to **CAL1** or **CAL2**.



Input Source

Use the **Input Source** menu to select between different video signals that may be connected to your monitor.

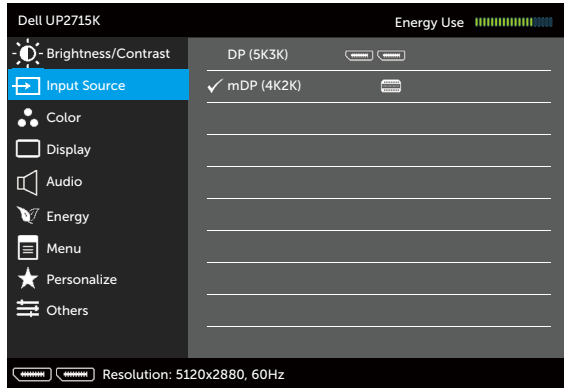

DP (5K3K)

Select **DP (5K3K)** input when you are using the DisplayPort (DP) connector. Press the  button to select the DisplayPort input source.

mDP (4K2K)

Select **mDP (4K2K)** input when you are using the Mini DisplayPort (DP) connector. Press the  button to select the Mini DisplayPort input source.



Color

Use the **Color Settings** menu to adjust the monitor's color settings.

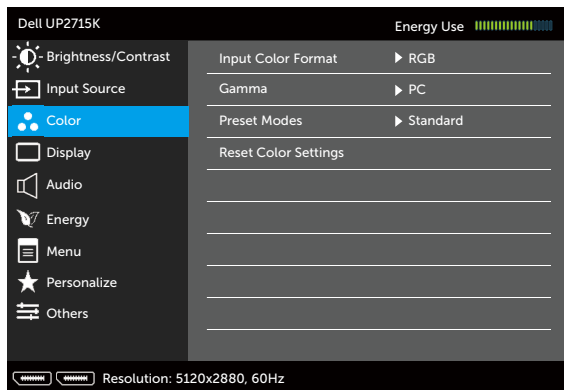

Input Color Format

Allows you to set the video input mode to:

- **RGB:** Select this option if your monitor is connected to a computer or DVD player using the HDMI or DP/Mini DP cable.
- **YPbPr:** Select this option if your DVD player supports only YPbPr output.

Gamma

Allows you to set the Gamma to **PC** or **MAC**.

Preset Modes

Allows you to choose from a list of preset color modes.

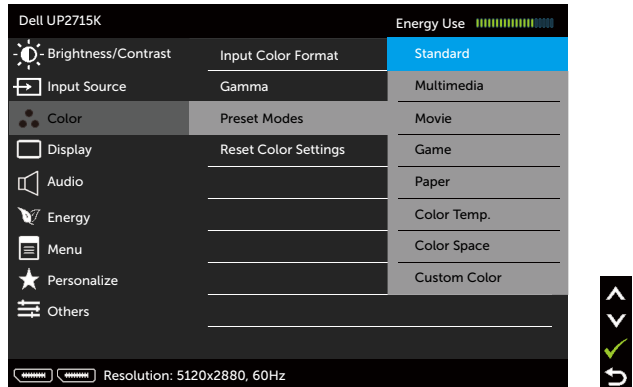

- **Standard:** Loads the monitor's default color settings. This is the default preset mode.
- **Multimedia:** Loads color settings ideal for multimedia applications. Applies to HDMI input with CEA timing (YUV color domain) only.
- **Movie:** Loads color settings ideal for movies. Applies to HDMI input with CEA timing (YUV color domain) only.
- **Game:** Loads color settings ideal for most gaming applications.
- **Paper:** Loads brightness and sharpness settings ideal for viewing text. Blend the text background to simulate paper media without affecting color images. Applies to RGB input format only.
- **Color Temp.:** The screen appears warmer with a red/yellow tint with slider set at 5,000K or cooler with blue tint with slider set at 10,000K.

- **Color Space:** Allows users to select the color space: **Adobe RGB**, **sRGB**, **CAL1**, **CAL2**.

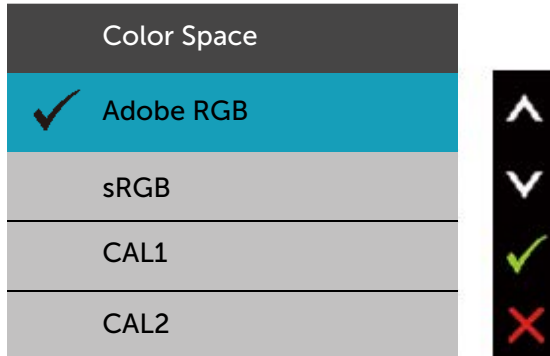

- **Adobe RGB:** This mode is compatible with Adobe RGB (99% coverage).
- **sRGB:** Emulates 100% sRGB.
- **CAL1/CAL2:** User calibrated preset mode using Dell Ultrasharp Color Calibration Software or other Dell approved software. Dell Ultrasharp Color Calibration Software works with the X-rite colorimeter i1Display Pro. The i1Display Pro can be purchased from the Dell Electronics, Software and Accessories website.

NOTE: Accuracy of **sRGB**, **Adobe RGB**, **CAL1** and **CAL2** are optimized for RGB input color format.

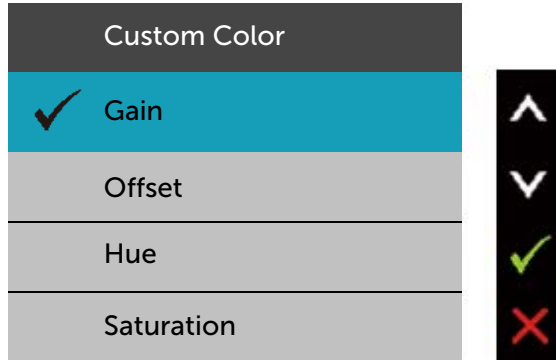

NOTE: **Factory Reset** will remove all calibrated data in **CAL1** and **CAL2**.

- **Custom Color:** Allows you to manually adjust the color settings. Press the  and  buttons to adjust the Red, Green, and Blue values and create your own preset color mode. Use the  and  buttons to select the Gain, Offset, Hue, Saturation.



- **Gain:** Select it to adjust input RGB signal gain level (default value are 100).
- **Offset:** Select it to adjust RGB black-level offset value (default value are 50) to control your monitor base color.
- **Hue:** Select it to adjust RGBCMY hue value individually (default value are 50).
- **Saturation:** Select it to adjust RGBCMY saturation value individually (default value are 50).

Hue

This feature can shift color of video image to green or purple. This is used to adjust the desired flesh tone color. Use  or  to adjust the hue from '0' to '100'.

Press  to increase the green shade of the video image.

Press  to increase the purple shade of the video image.

NOTE: Hue adjustment is available only for Movie and Game mode.

Saturation	<p>This feature can adjust the color saturation of the video image. Use ▲ or ▼ to adjust the saturation from '0' to '100'.</p> <p>Press ▲ to increase the monochrome appearance of the video image.</p> <p>Press ▼ to increase the colorful appearance of the video image.</p> <p>NOTE: Saturation adjustment is available only for video input.</p>
-------------------	---

Reset Color Settings	Resets your monitor's color settings to the factory defaults.
-----------------------------	---



Display	Use the Display Settings to adjust image.
----------------	--

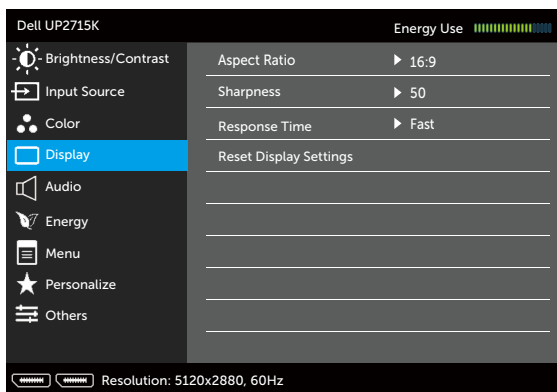

Aspect Ratio	Adjust the image ratio to Wide 16:9 , Auto Resize , 4:3 , or 1:1 .
---------------------	--

Sharpness	This feature can make the image look sharper or softer. Use ▲ or ▼ to adjust the sharpness from '0' to '100'.
------------------	---

Response Time	Allows you to set the Response Time to Normal or Fast .
----------------------	---

Reset Display Settings	Select this option to restore default display settings.
-------------------------------	---



Audio

Use the Audio Settings menu to adjust the audio settings.

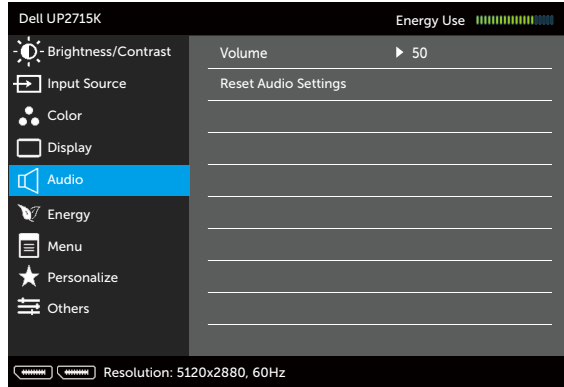

Volume

Allows you to increase the speaker volume.

Use **▲** and **▼** buttons to adjust the speaker volume from '0' to '100'.

Reset Audio Setting

Resets your monitor audio settings to the factory defaults.



Energy

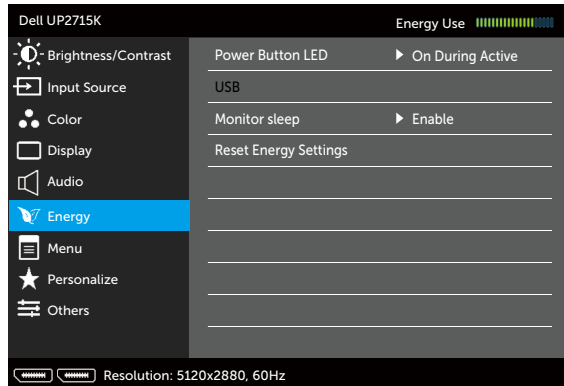

Power Button LED

Allows you to set the power LED indicator On or Off.

USB	Allows you to enable or disable USB function during monitor standby mode. NOTE: USB ON/OFF under standby mode is only available when the USB upstream cable is unplugged. This option will be greyed out when the USB upstream cable plugs in.
Monitor Sleep	Allow you to set Monitor sleep On or Off.
Reset Energy Settings	Select this option to restore default Energy Settings .



Menu

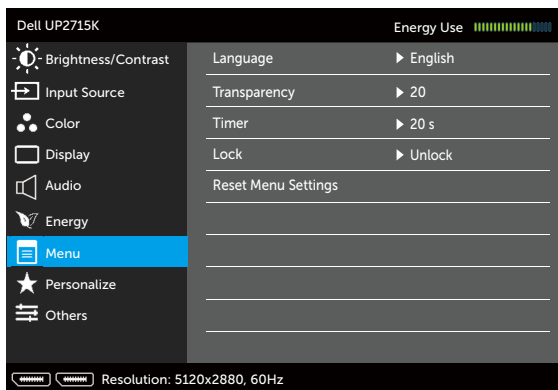

Language	Language option to set the OSD display to one of eight languages (English, Spanish, French, German, Brazilian Portuguese, Russian, Simplified Chinese or Japanese).
Transparency	This function is used to change the OSD background from opaque to transparent.
Timer	Sets the length of time the OSD will remain active after the last time you pressed a button. Use the ▲ and ▼ buttons to adjust the slider in 1 second increments, from 5 to 60 seconds.

Lock Controls user access to adjustments. When **Lock** is selected, no user adjustments are allowed. All buttons are locked.

NOTE:

Lock function – Either soft lock (through OSD menu) or hard lock (Press and hold the button above power button for 10 sec)

Unlock function – Only hard unlock (Press and hold the button above power button for 10 sec)

Reset Menu Settings Select this option to restore default **Menu** settings.



Personalize User can select from **Preset Modes, Brightness/Contrast, Input Source, Aspect Ratio** and set as shortcut key.

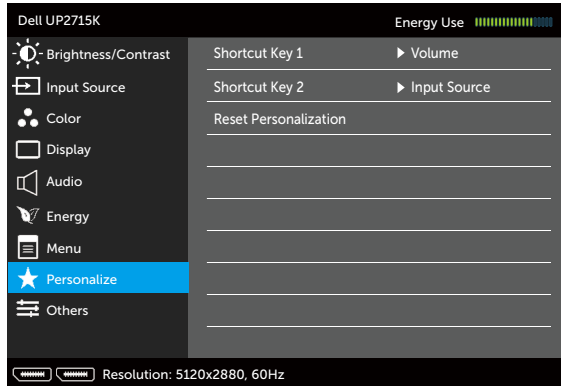

Reset Personalization Allows you to restore shortcut key to the default setting.



Other

Select this option to adjust the OSD settings, such as the DDC/CI, LCD Conditioning, and so on.

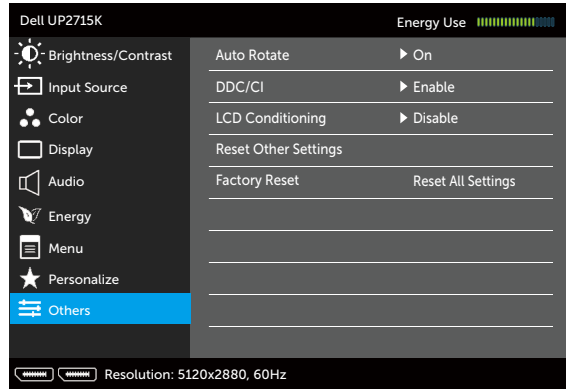

Auto Rotate

This display is equipped with an orientation sensor. Rotating the display from Landscape to Portrait (in wall mount) will automatically trigger the OSD to be rotated accordingly.

If Dell Display Manager (DDM) is installed and with suitable PC graphics card, the screen content will also be rotated accordingly.

Set **Auto Rotate** to **Off** to disable this feature.

DDC/CI

DDC/CI (Display Data Channel/Command Interface) allows your monitor parameters (brightness, color balance etc) to be adjustable via software on your computer. You can disable this feature by selecting **Disable**.

Enable this feature for best user experience and optimum performance of your monitor.

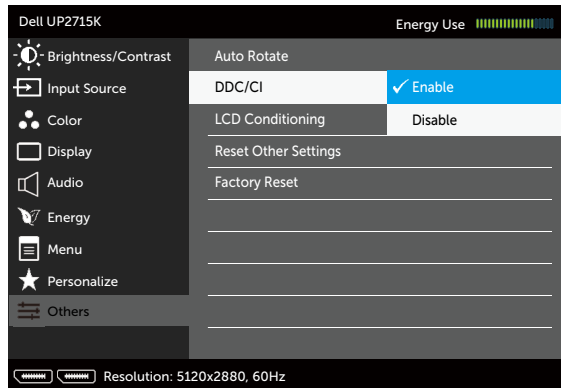

LCD Conditioning

Helps reduce minor cases of image retention. Depending on the degree of image retention, the program may take some time to run. You can enable this feature by selecting **Enable**.

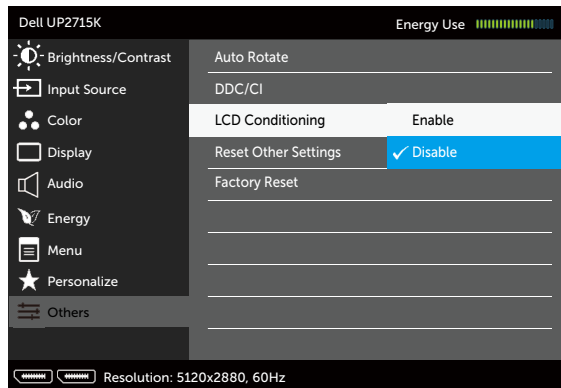

Reset Other Settings

Select this option to restore default other settings, such as DDC/CI.

Factory Reset

Reset all OSD settings to the factory preset values.

OSD Warning Messages

When the monitor does not support a particular resolution mode you will see the following message:

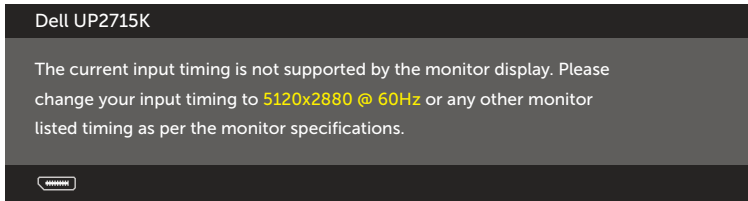

This means that the monitor cannot synchronize with the signal that it is receiving from the computer. See [Monitor Specifications](#) for the Horizontal and Vertical frequency ranges addressable by this monitor. Recommended mode is 5120 x 2880.

You will see the following message before the DDC/CI function is disabled.

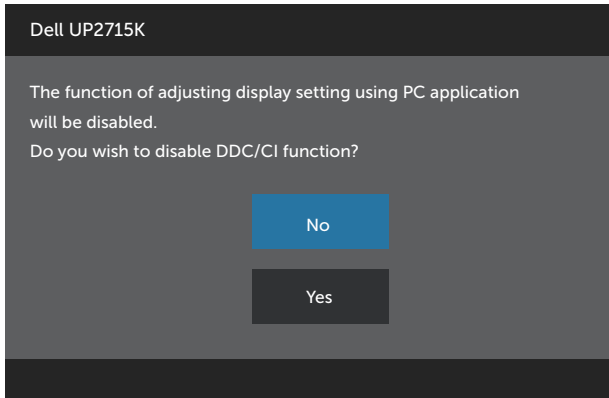

When monitor enters **Power Save Mode**, the following message appears:



Activate the computer and wake up the monitor to gain access to the [OSD](#). If you press any button other than the power button, one of the following messages will appear depending on the selected input:

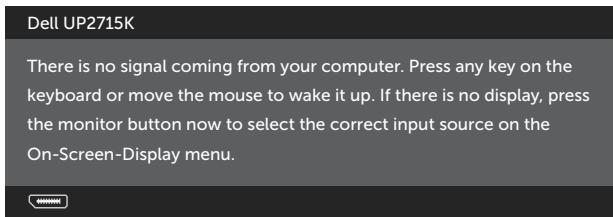

If either DP or m-DP input is selected and the corresponding cable is not connected, a floating dialog box as shown below appears.

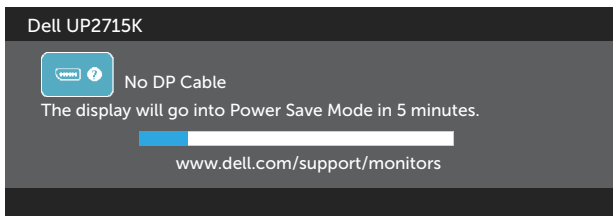

OR

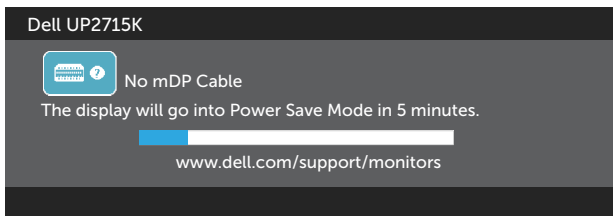

See [Troubleshooting](#) for more information.

Setting the Maximum Resolution

In Windows Vista[®], Windows[®] 7 Service Pack (SP1), Windows[®] 8, Windows[®] 8.1 or Windows[®] 10 :

1. For Windows[®] 8/ Windows[®] 8.1 only, select the Desktop tile to switch to classic desktop.
2. Right-click on the desktop and click **Screen Resolution**.
3. Click the Dropdown list of the Screen resolution and select **5120 x 2880**.
4. Click **OK**.

If you do not see 5120 x 2880 as an option, you may need to update your graphics driver. Depending on your computer, complete one of the following procedures:

If you have a Dell desktop or portable computer:

- Go to www.dell.com/support, enter your service tag, and download the latest driver for your graphics card.

If you are using a non-Dell computer (portable or desktop):

- Go to the support site for your computer and download the latest graphic drivers.
- Go to your graphics card website and download the latest graphic drivers.

NOTE: It may be necessary to adjust the font size when using the maximum resolution in this Display. To change the font size go to (Windows® 7, Windows® 8, Windows® 8.1 and Windows® 10):

Control Panel > Appearance and Personalization > Display

Refer to “Font Size Adjustment Guide” section for details.

Using the Tilt, Swivel, and Vertical Extension

NOTE: This is applicable for a monitor with a stand. When any other stand is bought, please refer to the respective stand setup guide for set up instructions.

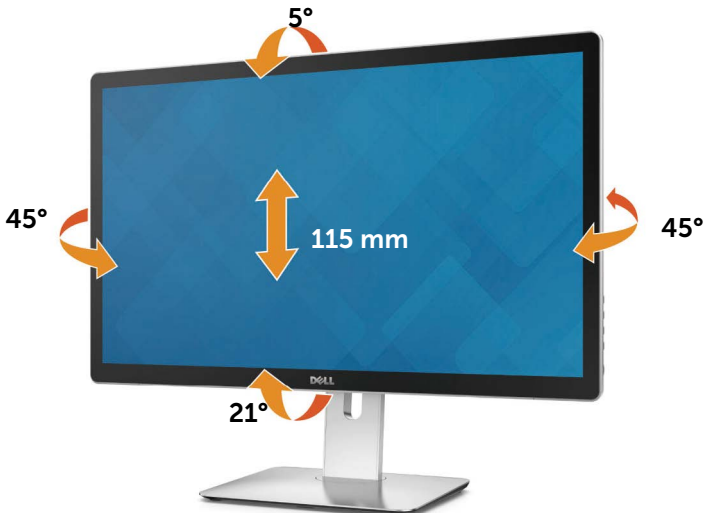

NOTE: The stand is detached when the monitor is shipped from the factory.

Rotating the Monitor

Before you rotate the monitor, your monitor should be fully vertically extended and fully tilted up to avoid hitting the bottom edge of the monitor.



- NOTE:** To use the Display Rotation function (Landscape versus Portrait view) with your Dell computer, you require an updated graphics driver that is not included with this monitor. To download the graphics driver, go to www.dell.com/support and see the Download section for Video Drivers for latest driver updates.
- NOTE:** When in Portrait View Mode, you may experience performance degradation in graphic-intensive applications (3D Gaming etc.).

Troubleshooting

△ CAUTION: Before you begin any of the procedures in this section, follow the [Safety Instructions](#).

Self-Test

Your monitor provides a self-test feature that allows you to check whether your monitor is functioning properly. If your monitor and computer are properly connected but the monitor screen remains dark, run the monitor self-test by performing the following steps:

1. Turn Off both your computer and the monitor.
2. Unplug the video cable from the back of the computer.
3. Turn On the monitor.

The floating dialog box should appear on-screen (against a black background) if the monitor cannot sense a video signal and is working correctly. While in self-test mode, the power LED remains white. Also, depending upon the selected input, one of the dialog boxes shown below will continuously scroll through the screen.

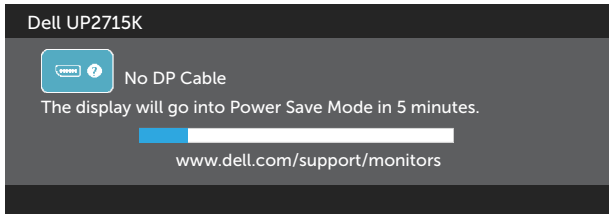

or

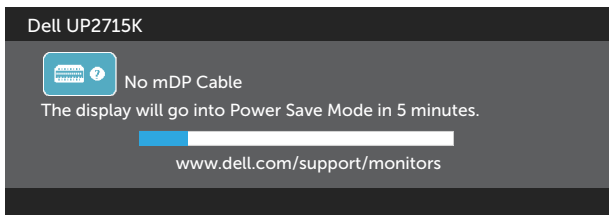

4. This box also appears during normal system operation, if the video cable becomes disconnected or damaged.
5. Turn Off your monitor and reconnect the video cable; then turn On both your computer and the monitor.

If your monitor screen remains blank after you use the previous procedure, check your video controller and computer, because your monitor is functioning properly.

Built-in Diagnostics

Your monitor has a built-in diagnostic tool that helps you determine if the screen abnormality you are experiencing is an inherent problem with your monitor, or with your computer and video card.

 **NOTE:** You can run the built-in diagnostics only when the video cable is unplugged and the monitor is in self-test mode.

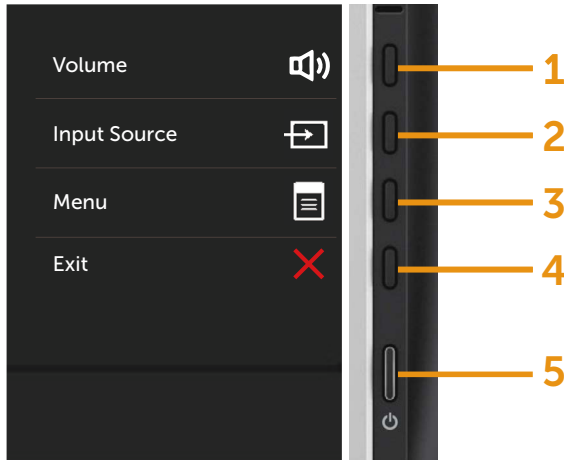

To run the built-in diagnostics:

1. Ensure that the screen is clean (no dust particles on the surface of the screen).
2. Unplug the video cable(s) from the back of the computer or monitor. The monitor then goes into the self-test mode.
3. Press and hold the Button **1** and Button **4** on the front panel simultaneously for 2 seconds. A gray screen appears.
4. Carefully inspect the screen for abnormalities.
5. Press the Button **4** on the front panel again. The color of the screen changes to red.
6. Inspect the display for any abnormalities.
7. Repeat steps 5 and 6 to inspect the display in green, blue, black, white screens.

The test is complete when the white screen appears. To exit, press the Button **4** again.

If you do not detect any screen abnormalities upon using the built-in diagnostic tool, the monitor is functioning properly. Check the video card and computer.

Common Problems

The following table contains general information about common monitor problems you might encounter and the possible solutions:

Problem	Cause	Solution
No Video/Power LED Off	No picture	<ul style="list-style-type: none">• Ensure that the video cable connecting the monitor and the computer is properly connected and secure.• Verify that the power outlet is functioning properly using any other electrical equipment.• Ensure that the power button is depressed fully.• Ensure that the correct input source is selected via the Input Source menu.• Check the Power Button LED option under Energy Settings in OSD Menu
No Video/Power LED On	No picture or no brightness	<ul style="list-style-type: none">• Increase brightness & contrast controls via OSD.• Perform monitor self-test feature check.• Check for bent or broken pins in the video cable connector.• Run the built-in diagnostics.• Ensure that the correct input source is selected via the Input Source menu.
Missing Pixels	LCD screen has spots	<ul style="list-style-type: none">• Cycle power On-Off.• Pixel that is permanently Off is a natural defect that can occur in LCD technology.• For more information on Dell Monitor Quality and Pixel Policy, see Dell Support site at: http://www.dell.com/support/monitors.

Stuck-on Pixels	LCD screen has bright spots	<ul style="list-style-type: none"> • Cycle power On-Off. • Pixel that is permanently Off is a natural defect that can occur in LCD technology. • For more information on Dell Monitor Quality and Pixel Policy, see Dell Support site at: http://www.dell.com/support/monitors.
Brightness Problems	Picture too dim or too bright	<ul style="list-style-type: none"> • Reset the monitor to Factory Settings. • Adjust brightness & contrast controls via OSD.
Safety Related Issues	Visible signs of smoke or sparks	<ul style="list-style-type: none"> • Do not perform any troubleshooting steps. • Contact Dell immediately.
Intermittent Problems	Monitor malfunctions on & off	<ul style="list-style-type: none"> • Ensure that the video cable connecting the monitor to the computer is connected properly and is secure. • Reset the monitor to Factory Settings. • Perform monitor self-test feature check to determine if the intermittent problem occurs in selftest mode.
Missing Color	Picture missing color	<ul style="list-style-type: none"> • Perform monitor self-test feature check. • Ensure that the video cable connecting the monitor to the computer is connected properly and is secure. • Check for bent or broken pins in the video cable connector.

Wrong Color	Picture color not good	<ul style="list-style-type: none">• Try different color Preset Modes in Color Settings OSD.• Change the Input Color Format to RGB or YPbPr in the Color Settings OSD.• Run the built-in diagnostics.
Image retention from a static image left on the monitor for a long period of time	Faint shadow from the static image displayed appears on the screen	<ul style="list-style-type: none">• Use the Power Management feature to turn Off the monitor at all times when not in use (for more information, see Power Management Modes).• Alternatively, use a dynamically changing screensaver.

Product Specific Problems

Problem	Cause	Solution
Screen image is too small	Image is centered on screen, but does not fill entire viewing area	<ul style="list-style-type: none">• Check the Aspect Ratio setting in Display Settings OSD• Reset the monitor to Factory Settings.
Cannot adjust the monitor with the buttons on the front panel	OSD does not appear on the screen	<ul style="list-style-type: none">• Turn Off the monitor, unplug the power cord, plug back, and then turn On the monitor.
No Input Signal when user controls are pressed	No picture, the LED light is white	<ul style="list-style-type: none">• Check the signal source. Ensure the Computer is not in the power saving mode by moving the mouse or pressing any key on the keyboard.• Check to make sure Video Source to DisplayPort or Mini DisplayPort or HDMI is powered and playing video media.• Check whether the signal cable is plugged in properly. Re-plug the signal cable if necessary.• Reset the computer or video player.
The picture does not fill the entire screen	The picture cannot fill the height or width of the screen	<ul style="list-style-type: none">• Due to different video formats (aspect ratio) of DVDs, the monitor may display in full screen.• Run the built-in diagnostics.
Unable to see Post-screen or Vbios setting	May miss the post screen or Vbios setting during boot up	<ul style="list-style-type: none">• Disable sleep mode in monitor and reboot PC.• Turn Off the Monitor Sleep in Energy settings OSD, then reboot PC to show the Post-screen or Vbios.
Post/BIOS is observed on one side of the screen.	The picture cannot fill the whole screen.	<ul style="list-style-type: none">• This is expected behavior for some graphics card. Full screen will be displayed after graphics card driver is loaded.

Troubleshooting the Card Reader

 **CAUTION:** Do not remove the device while reading or writing media. Doing so may cause loss of data or malfunction in the media.

Problem	Cause	Solution
Drive letter is not assigned. (Windows® XP only)	Conflict with network drive letter.	<ul style="list-style-type: none">• – Right-click the My Computer icon on the desktop.– Click on Manage.– In the Computer Management window that appears select Disk Management.– In the list of drives that appear in the right panel, right-click the removable drive and then click Change Drive Letter and Paths.– Select Change, and in the drop-down box that appears, specify a drive letter for the removable drive. <p>NOTE: While choosing the drive letter choose one that is not assigned to the mapped network drives.</p> <ul style="list-style-type: none">– Click OK, then click OK once again in the screen that appears.
Drive letter is assigned, but the media is not accessible	The media needs reformatting.	<ul style="list-style-type: none">• Right-click the drive in Explorer and choose Format from the resulting menu.

<p>The media has been ejected during writing or erasing.</p>	<p>Displays the error message, "Error copying file or folder." Displays the error message, "Cannot write folder (folder name) or file (file name)," during writing, or, "Cannot remove folder (folder name) or file (file name),". While erasing, you cannot write or erase in the same folder or file name.</p>	<ul style="list-style-type: none"> • Reinsert the media and write or erase again. • Format the media for writing or erasing the same folder or file name.
<p>Despite the disappearance of the pop-up window, the media has been ejected while the LED was blinking.</p>	<p>Although the pop-up window disappears during writing, if you eject your media while the LED is still blinking, then you cannot complete your action on the media.</p>	<ul style="list-style-type: none"> • Format the media for writing or erasing the same folder or file name.
<p>Cannot format or write on the media.</p>	<p>Write-protect switch is enabled.</p>	<ul style="list-style-type: none"> • Verify that the write-protect switch of the media is unlocked.
<p>Card reader is not working</p>	<p>USB interface is not working.</p>	<ul style="list-style-type: none"> • Check that your monitor is powered On. • Reconnect the upstream cable from your computer to the monitor. • Reinsert the media. • Switch Off and then turn On the monitor again. • Reboot the computer.

Appendix

WARNING: Safety Instructions

For displays with glossy bezels the user should consider the placement of the display as the bezel may cause disturbing reflections from surrounding light and bright surfaces.

 **WARNING:** Use of controls, adjustments, or procedures other than those specified in this documentation may result in exposure to shock, electrical hazards, and/or mechanical hazards.

For information on safety instructions, see the Safety, Environmental, and Regulatory Information (SERI).

FCC Notices (U.S. Only) and Other Regulatory Information

For FCC notices and other regulatory information, see the regulatory compliance website located at: http://www.dell.com/regulatory_compliance.

Contact Dell

For customers in the United States, call 800-WWW-DELL (800-999-3355).

 **NOTE:** If you do not have an active Internet connection, you can find contact information on your purchase invoice, packing slip, bill, or Dell product catalog.

Dell provides several online and telephone-based support and service options. Availability varies by country and product, and some services may not be available in your area. To contact Dell for sales, technical support, or customer service issues:

1. Visit <http://www.dell.com/support/>.
2. Verify your country or region in the Choose A Country/Region dropdown menu at the bottom of the page.
3. Click Contact Us on the left side of the page.
4. Select the appropriate service or support link based on your need.
5. Choose the method of contacting Dell that is convenient for you.

Setting Up Your Monitor Display

Setting the display resolution to 5120 x 2880 (maximum)

For best performance, set the display resolution to 5120 x 2880 pixels by performing the following steps:

In Windows Vista®, Windows® 7, Windows® 8/Windows® 8.1 or Windows® 10:

1. For Windows 8 and Windows 8.1 only, select the Desktop tile to switch to classic desktop.
2. Right-click on the desktop and click **Screen Resolution**.
3. Click the Dropdown list of the Screen Resolution and select 5120 x 2880.
4. Click **OK**.

If you do not see the recommended resolution as an option, you may need to update your graphics driver. Please choose the scenario below that best describes the computer system you are using, and follow the given steps.

Dell computer

1. Go to www.dell.com/support, enter your service tag, and download the latest driver for your graphics card.
2. After installing the drivers for your graphics adapter, attempt to set the resolution to 5120 x 2880 again.

 **NOTE:** If you are unable to set the resolution to 5120 x 2880, please contact Dell to inquire about a graphics adapter that supports these resolutions.

Non-Dell computer

In Windows Vista®, Windows® 7, Windows® 8/Windows® 8.1 or Windows® 10:

1. For Windows 8 and Windows 8.1 only, select the Desktop tile to switch to classic desktop.
2. Right-click on the desktop and click Change Display Settings.
3. Click **Advanced Settings**.
4. Identify your graphics controller supplier from the description at the top of the window (e.g. NVIDIA, ATI, Intel etc.).
5. Refer to the graphic card provider website for updated driver (for example, <http://www.ATI.com> OR <http://www.NVIDIA.com>).
6. After installing the drivers for your Graphics Adapter, attempt to set the resolution to 5120 x 2880 again.

 **NOTE:** If you are unable to set the recommended resolution, please contact the manufacturer of your computer or consider purchasing a graphics adapter that supports the video resolution.

Font Size Adjustment Guide

At resolution 5120x2880 UP2715K is at 218PPI. It is recommended to enlarge the desktop icon for easy viewing. Please follow below guide to change font size to 150% or higher.

Windows 7 & 8

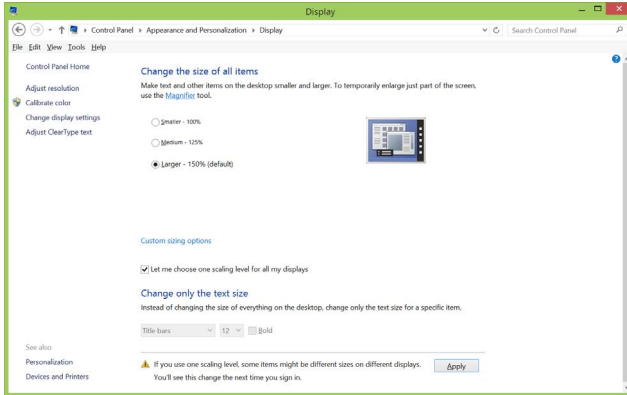

Select "Larger - 150%"

Control Panel > Appearance and Personalization > Display

Windows 8.1

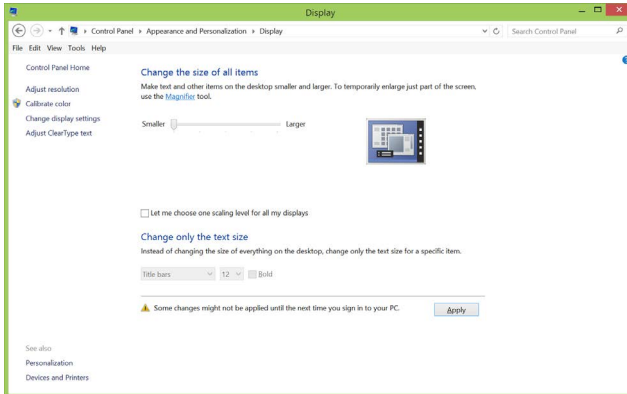

Select "Larger, up to 200%"

Control Panel > Appearance and Personalization > Display

Windows 10

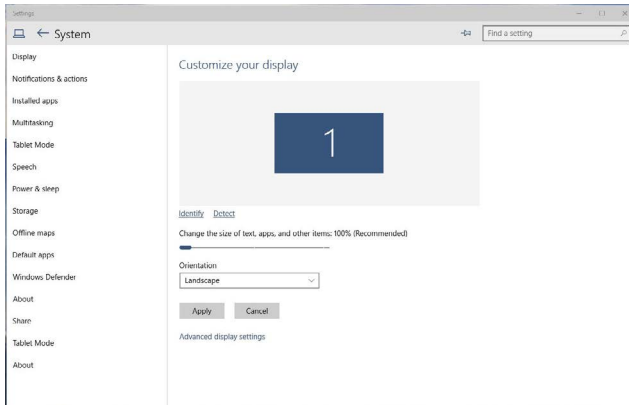

Select "Larger - 150%"

Control Panel > Appearance and Personalization > Display

Procedures for setting up dual monitors in Windows Vista®, Windows® 7, Windows® 8, Windows® 8.1 or Windows® 10

Content

- (a) For Windows Vista®
- (b) For Windows® 7
- (c) For Windows® 8/Windows® 8.1
- (d) For Windows® 10
- (e) Setting Display Styles For Multiple Monitor

(a) For Windows Vista®

Connect the external monitor(s) to your laptop or desktop using a DP cable and follow any of the below setup method.

Method 1: Using keyboard shortcut "Win+P"

1. Press the **Windows logo key + P** on your keyboard.
2. While holding down the **Windows logo key**, press **P** to toggle between the display selections.



Method 2: Using the "Personalize"

1. Right-click on the desktop and click **Personalize**.



2. Click **Display Settings**.

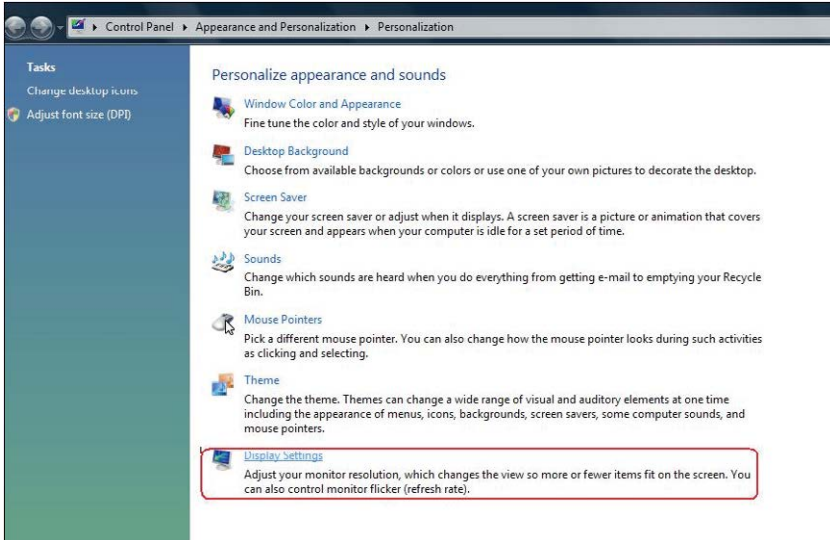

3. Click **Identify Monitors**.

- You may need to restart your system and repeat steps 1 to 3 if the system does not detect the added monitor.

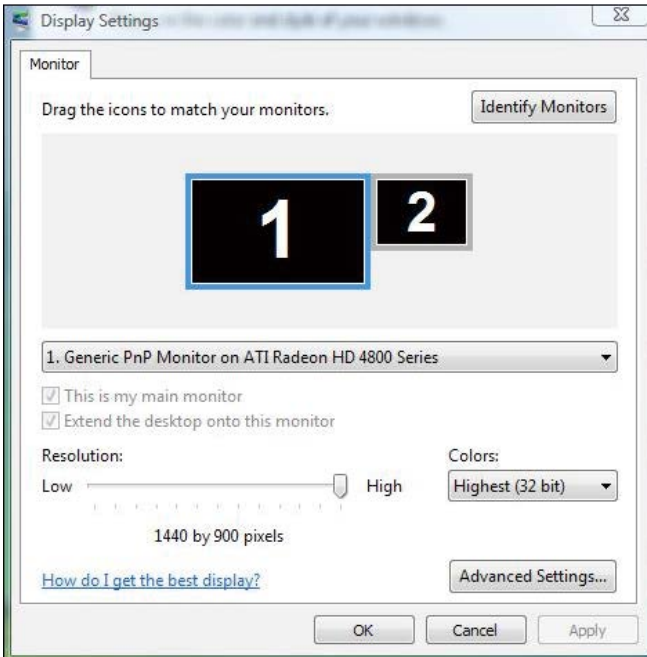

(b) For Windows® 7

Connect the external monitor(s) to your laptop or desktop using a DP cable and follow any of the below setup method.

Method 1: Using keyboard shortcut “Win+P”

1. Press the **Windows logo key** + **P** on your keyboard.
2. While holding down the **Windows logo key**, press **P** to toggle between the display selections.



Method 2: Using the “Screen Resolution” menu

1. Right-click on the desktop and click **Screen resolution**.

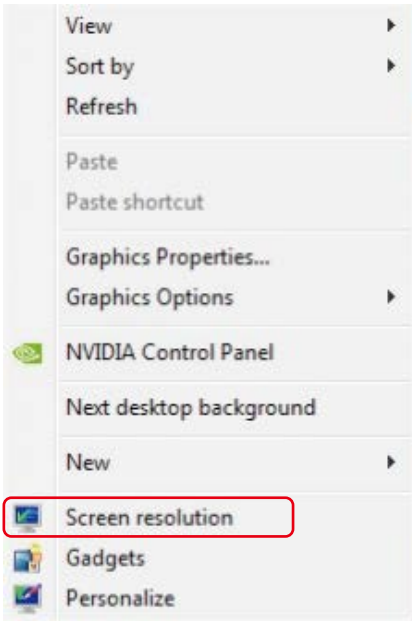

2. Click **Multiple displays** to choose a display selection. If you do not see the additional monitor listed, click **Detect**.
 - You may need to restart your system and repeat steps 1 to 2 if the system does not detect the added monitor.

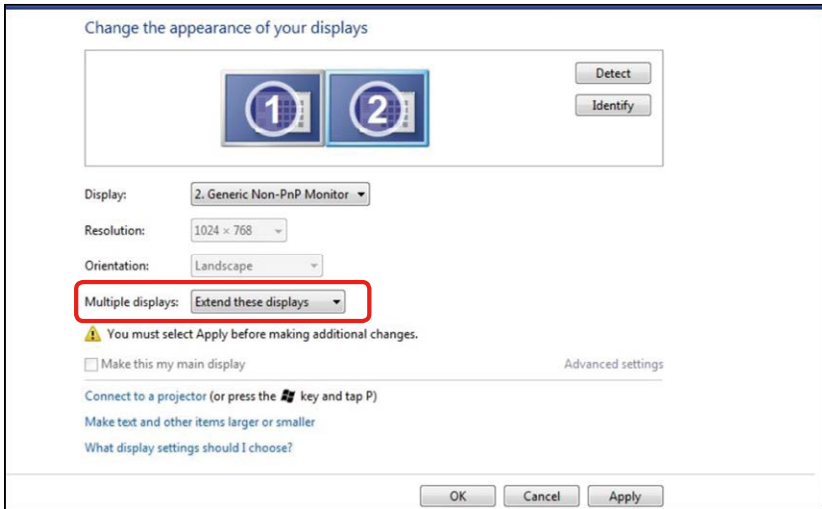

(c) **For Windows® 8/Windows® 8.1**

Connect the external monitor(s) to your laptop or desktop using a video cable (DP, HDMI etc.) and follow any of the below setup method.

Method 1: Using keyboard shortcut “Win+P”

1. Press the **Windows logo key** + **P** on your keyboard.
2. While holding down the **Windows logo key**, press **P** to toggle between the display selections.

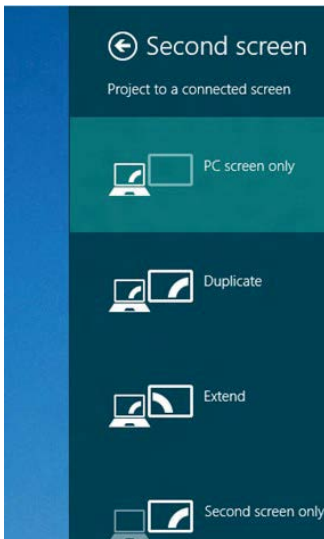

Method 2: Using the “Screen Resolution” menu

1. From the **Start** screen, select **Desktop** tile to switch to the Classic Windows desktop.



2. Right-click on the desktop and click **Screen resolution**.

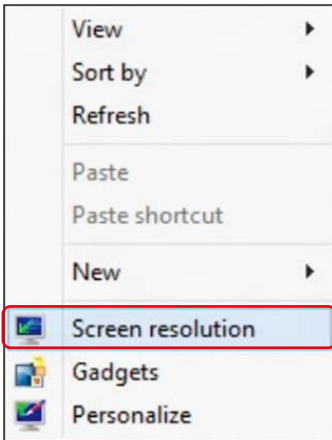

3. Click **Multiple displays** to choose a display selection. If you do not see the additional monitor listed, click **Detect**.

- You may need to restart your system and repeat steps 1 to 3 if the system does not detect the added monitor.

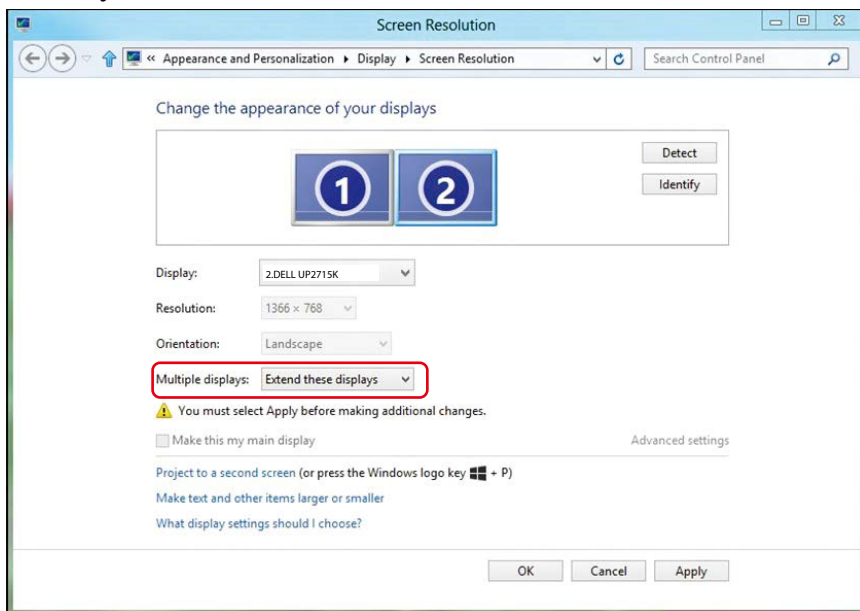

(d) For Windows® 10

Connect the external monitor(s) to your laptop or desktop using a video cable (DP, HDMI etc.) and follow any of the below setup method.

Method 1: Using keyboard shortcut “Win+P”

1. Press the **Windows logo key + P** on your keyboard.
2. While holding down the **Windows logo key**, press **P** to toggle between the display selections.

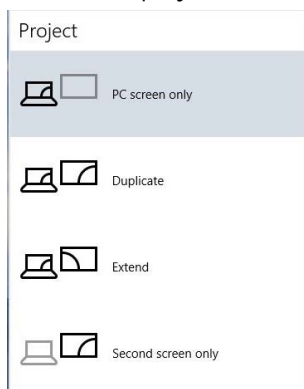

Method 2: Using the “Display settings” menu

1. Right-click on the desktop and click **Display settings**.

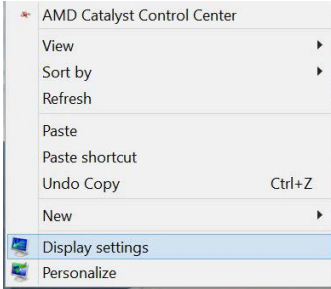

2. Click **Multiple displays** to choose a display selection. If you do not see the additional monitor listed, click **Detect**.
 - You may need to restart your system and repeat steps 1 to 3 if the system does not detect the added monitor.

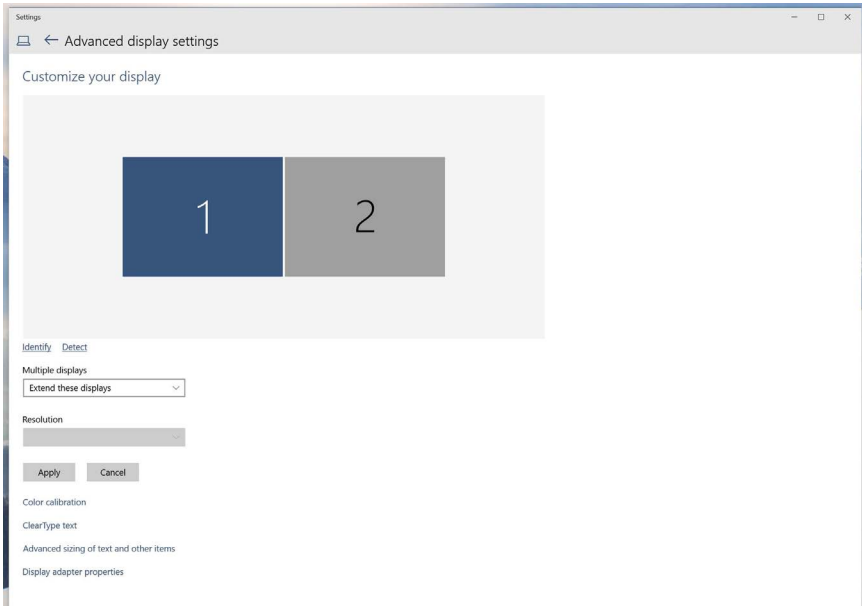

(e) Setting Display Styles For Multiple Monitor

After the external monitor(s) have been set up, users can select the desired display style from Multiple displays menu: Duplicate, Extend, Show Desktop On.



NOTE: Please optimize the size of the icons and fonts on multiple monitors to suit the user preference.

- Duplicate these displays: Duplicate the same screen on two monitors with the same resolution, chosen based on the monitor with a lower resolution.

(i) For Windows Vista®

[DUPLICATE NOT AVAILABLE]

(ii) For Windows® 7

Change the appearance of your displays



Display: 1. Mobile PC Display

Resolution: 1024 × 768

Orientation: Landscape

Multiple displays: Extend these displays

You must select a display style when you make additional changes.

Make this my main display

- Duplicate these displays
- Extend these displays
- Show desktop only on 1
- Show desktop only on 2

Advanced settings

Connect to a projector (or press the key and tap P)

Make text and other items larger or smaller

What display settings should I choose?

OK

Cancel

Apply

(iii) For Windows® 8/Windows® 8.1

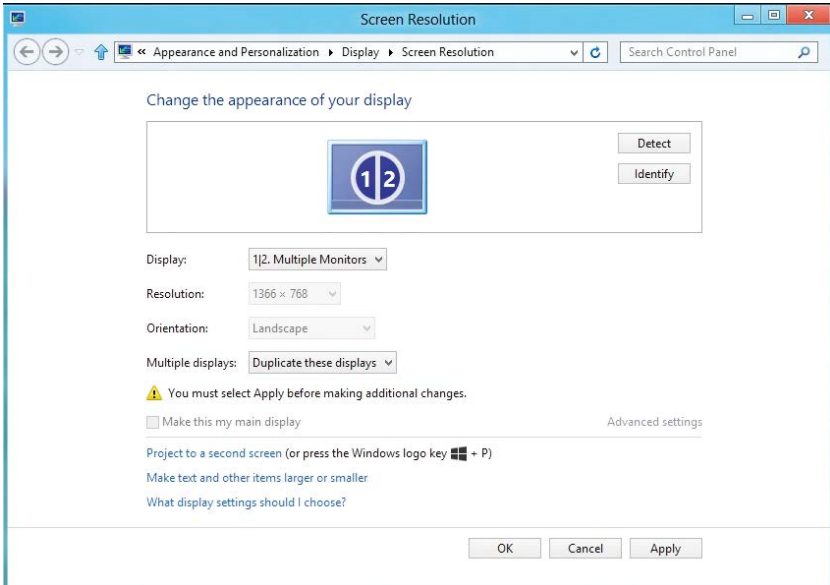

(iv) For Windows® 10

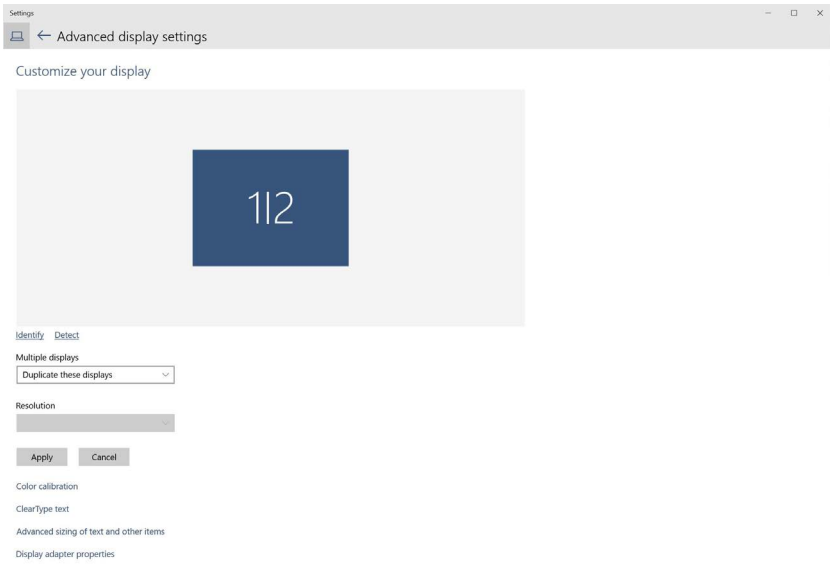

■ **Extend these displays:** This option is recommended when an external monitor is connected to a laptop, and each monitor can display different screen independently to improve user convenience. The relative position of the screens can be set up here, for example monitor 1 may be set up to be to the left of monitor 2 or vice versa. This depends on the physical position of the LCD monitor in relation to the laptop. The horizontal line displayed on both monitors can be based on the laptop or external monitor. These are all adjustable options, and all a user need do is drag the monitor of the main screen to the extended monitor.

(i) **For Windows Vista®**

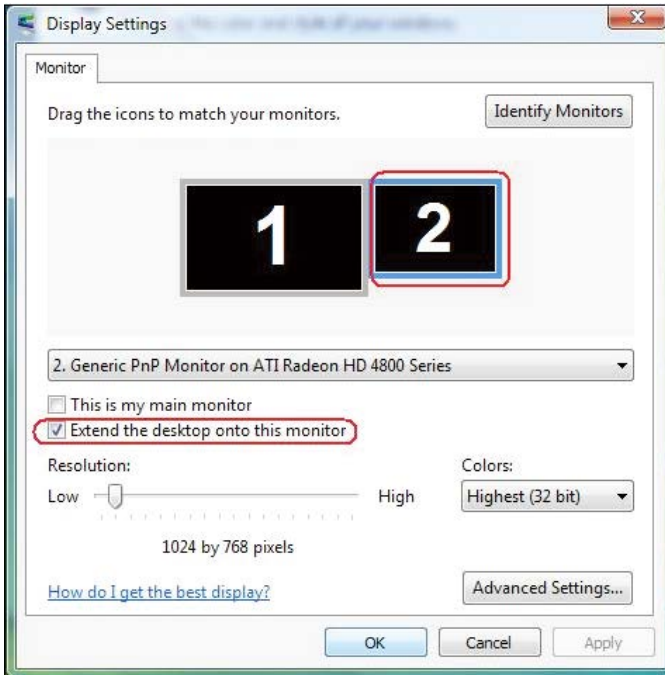

(ii) For Windows® 7

Change the appearance of your displays

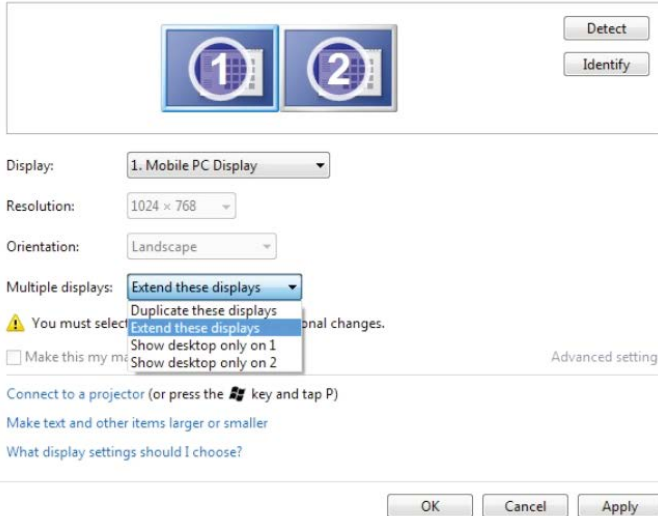

The screenshot shows the Windows 7 Display Settings dialog box. At the top, there are two display icons labeled '1' and '2'. To the right are 'Detect' and 'Identify' buttons. Below the icons, the 'Display' dropdown is set to '1. Mobile PC Display'. The 'Resolution' is '1024 x 768' and 'Orientation' is 'Landscape'. The 'Multiple displays' dropdown is open, showing options: 'Extend these displays' (selected), 'Duplicate these displays', 'Show desktop only on 1', and 'Show desktop only on 2'. A warning icon and text state: 'You must select one of these options before making additional changes.' There is an unchecked checkbox for 'Make this my main display' and a link for 'Advanced settings'. Below the dialog are 'OK', 'Cancel', and 'Apply' buttons.

(iii) For Windows® 8/Windows® 8.1

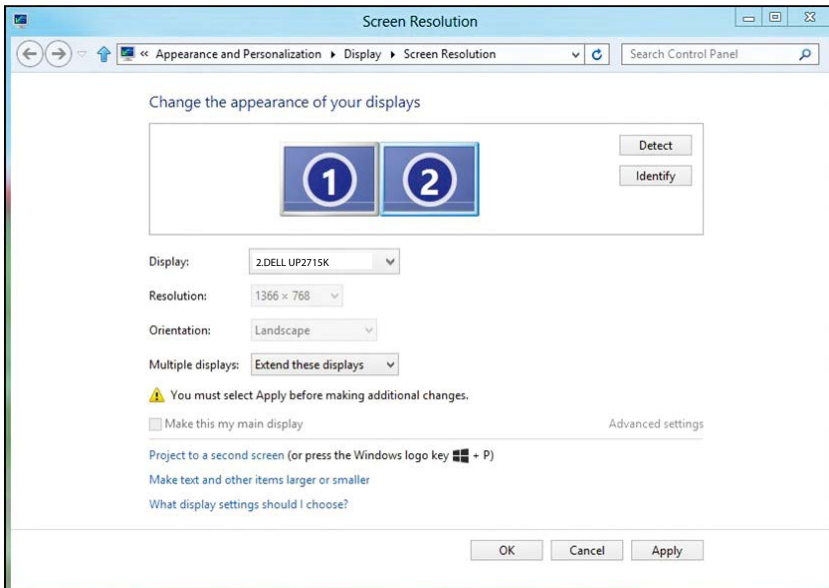

The screenshot shows the Windows 8/8.1 Screen Resolution Control Panel window. The title bar reads 'Screen Resolution'. The breadcrumb path is '<< Appearance and Personalization >> Display > Screen Resolution'. The main content area is titled 'Change the appearance of your displays' and contains the same display icons and buttons as the Windows 7 dialog. The 'Display' dropdown is set to '2.DELL UP2715K'. The 'Resolution' is '1366 x 768' and 'Orientation' is 'Landscape'. The 'Multiple displays' dropdown is open, showing options: 'Extend these displays' (selected), 'Duplicate these displays', 'Show desktop only on 1', and 'Show desktop only on 2'. A warning icon and text state: 'You must select Apply before making additional changes.' There is an unchecked checkbox for 'Make this my main display' and a link for 'Advanced settings'. Below the window are 'OK', 'Cancel', and 'Apply' buttons.

(iv) For Windows® 10

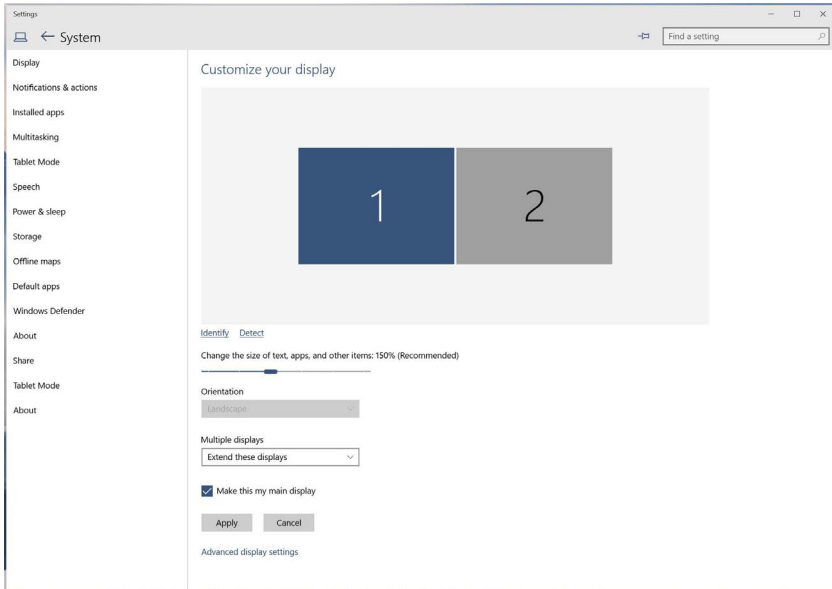

■ **Show desktop only on...:** Display the status of a particular monitor.

This option is typically chosen when the laptop is used as a PC so the user can enjoy a large external monitor. Most current laptops support mainstream resolutions. As shown in the figure above, the resolution of the laptop monitor is only 3840 x 2160, but after connecting a 27" external LCD monitor, users can immediately improve their visual enjoyment to 5120 x 2880 UHD quality.

(i) For Windows Vista®

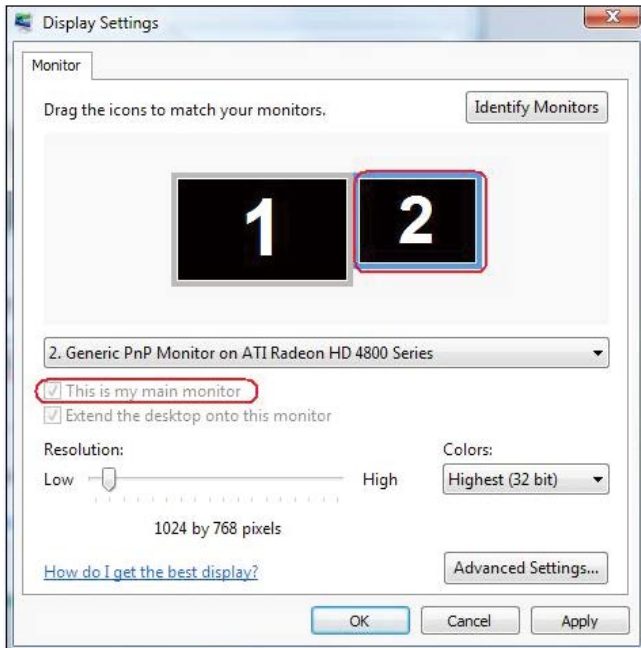
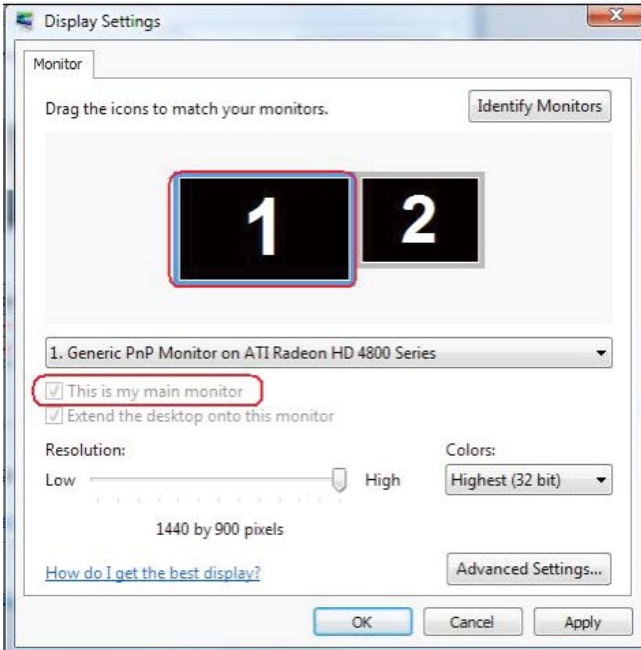

(ii) For Windows® 7

Change the appearance of your displays

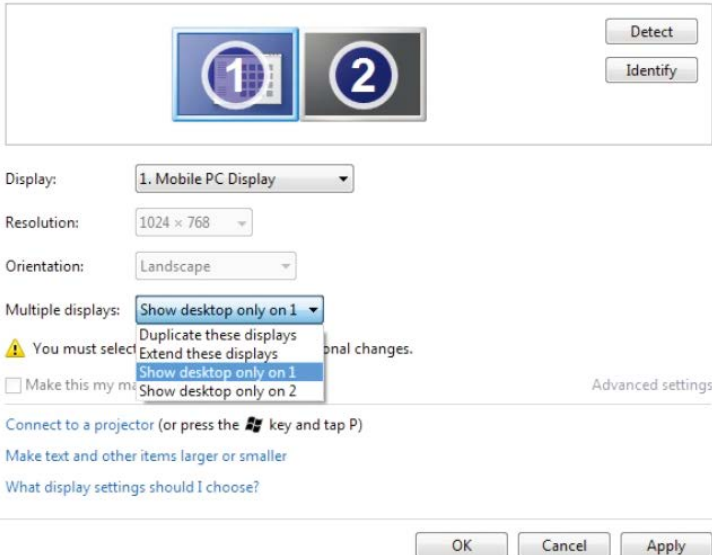

Display: 1. Mobile PC Display

Resolution: 1024 × 768

Orientation: Landscape

Multiple displays: Show desktop only on 1

⚠ You must select an option. You can't make any other changes.

Make this my main display

Advanced settings

Connect to a projector (or press the **Win** key and tap P)

Make text and other items larger or smaller

What display settings should I choose?

OK Cancel Apply

Change the appearance of your displays

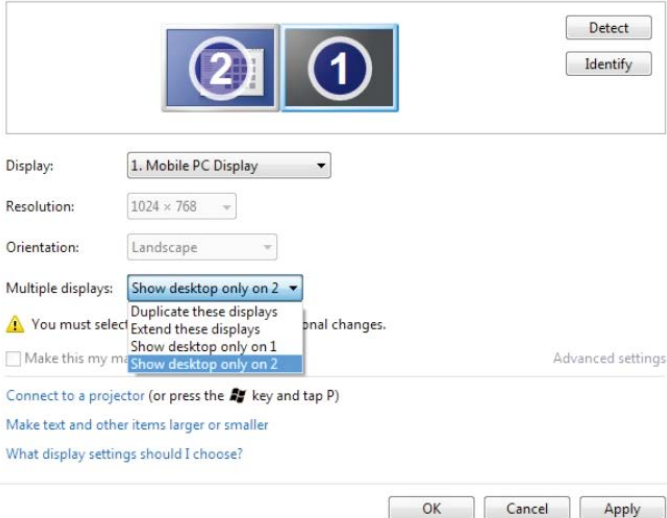

Display: 1. Mobile PC Display

Resolution: 1024 × 768

Orientation: Landscape

Multiple displays: Show desktop only on 2

⚠ You must select an option. You can't make any other changes.

Make this my main display

Advanced settings

Connect to a projector (or press the **Win** key and tap P)

Make text and other items larger or smaller

What display settings should I choose?

OK Cancel Apply

(iii) For Windows® 8/Windows® 8.1

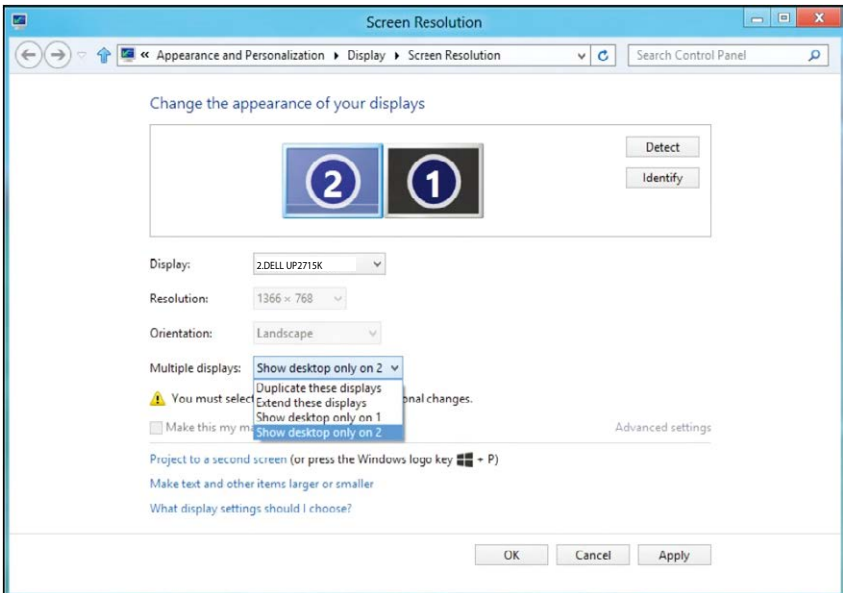
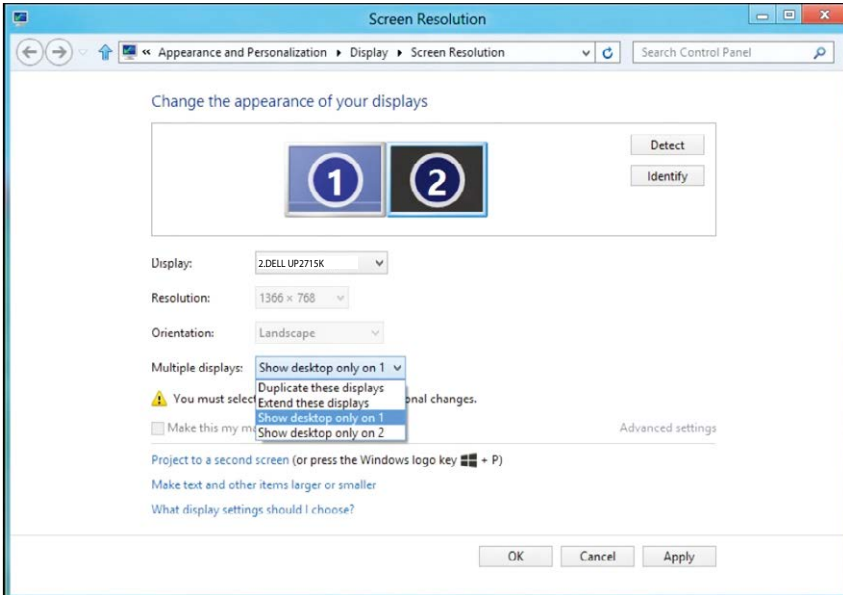

(iv) For Windows® 10

