



Dell™ Dimension™ 2300

[Technical Overview](#)
[Controls and Lights](#)
[Solving Problems](#)
[Advanced Troubleshooting](#)
[Technical Specifications](#)
[System Setup Program](#)
[Adding and Replacing Parts](#)
[Documentation](#)

Hints, Notices, and Cautions

-  **HINT:** A HINT indicates important information that helps you make better use of your computer.
 -  **NOTICE:** A NOTICE indicates either potential damage to hardware or loss of data and tells you how to avoid the problem.
 -  **CAUTION:** A CAUTION indicates a potential for property damage, personal injury, or death.
-

Abbreviations and Acronyms

For a complete list of abbreviations and acronyms, see the [Tell Me How](#) help file.

Information in this document is subject to change without notice.
© 2002 Dell Computer Corporation. All rights reserved.

Reproduction in any manner whatsoever without the written permission of Dell Computer Corporation is strictly forbidden.

Trademarks used in this text: *Dell*, the *DELL* logo, and *Dimension* are trademarks of Dell Computer Corporation; *Intel*, *Pentium*, and *Celeron* are registered trademarks of Intel Corporation; *Microsoft* and *Windows* are registered trademarks of Microsoft Corporation; *Adobe* is a trademark of Adobe Systems Incorporated, which may be registered in certain jurisdictions.

Other trademarks and trade names may be used in this document to refer to either the entities claiming the marks and names or their products. Dell Computer Corporation disclaims any proprietary interest in trademarks and trade names other than its own.

October 2002 Rev. A01

Advanced Troubleshooting

Dell™ Dimension™ 2300

- [Beep Codes](#)
- [System Messages](#)
- [Using System Restore](#)
- [Drivers](#)
- [Resolving Software and Hardware Incompatibilities](#)
- [Reinstalling Microsoft® Windows® XP](#)

Beep Codes

If the monitor cannot display errors or problems during POST, the computer might emit a series of beeps (a beep code) that identifies the problem.

[Reseating the memory modules](#) may fix the POST beep code errors listed below. If the problem persists, see "Contacting Dell" in your *Owner's Manual* for instructions on obtaining technical assistance.

Code	Cause
1 long beep: 1 short beep	Memory is not installed or is not detected.
1 long beep: 2 short beeps	Memory is detected, but a memory failure has occurred.
1 long beep: 3 short beeps	Memory is detected, but is incompatible with the computer.

If you hear one of the following POST beep codes, see "Contacting Dell" in your *Owner's Manual* for instructions on obtaining technical assistance.

Code	Cause
2 long beeps: 1 short beep	CMOS checksum error
2 long beeps: 2 short beeps	Video subsystem failure
2 long beeps: 3 short beeps	IDE subsystem failure
3 long beeps: 1 short beep	USB over-current condition detected

System Messages

Message	Possible Cause	Corrective Action
CMOS Checksum Error	A defective device or power surge can cause checksum errors.	See "Contacting Dell" in your <i>Owner's Manual</i> for instructions on obtaining technical assistance.
CPU fan not detected	The microprocessor fan cable is not plugged in or is defective.	Ensure that the microprocessor fan is connected to the fan connector on the system board.
Floppy Not Detected	The floppy drive cable may be disconnected or damaged.	Ensure that the cable properly connects the floppy drive to the system board .
Keyboard not detected	The keyboard is not detected.	Ensure that the keyboard is connected correctly and is not damaged.
Memory Size has changed	A memory size change occurred.	Reseat the memory modules .
Memory Test failed	The memory does not pass the memory test.	Reseat the memory modules .
No Boot Device Detected	The BIOS does not detect a bootable device.	Verify the boot sequence in the system setup program .
S.M.A.R.T Advisory Error	A S.M.A.R.T.-capable device may be defective.	See "Contacting Dell" in your <i>Owner's Manual</i> for instructions on obtaining technical assistance.

Using System Restore

The Microsoft® Windows® XP operating system provides System Restore to allow you to return your computer to an earlier operating state (without affecting data files) if changes to the hardware, software, or other system settings have left the computer in an undesirable operating state. See Windows Help for information on using System Restore.

 **NOTICE:** Make regular backups of your data files. System Restore does not monitor your data files or recover them.

Creating a Restore Point

1. Click the **Start** button.
2. Click **Help and Support**.
3. Click **System Restore**.
4. Follow the instructions on the screen.

Restoring the Computer to an Earlier Operating State

If problems occur after installing a device driver, first try using [Device Driver Rollback](#). If that is unsuccessful, then use System Restore.

 **NOTICE:** Before restoring the computer to an earlier operating state, save and close all open files and close all open programs. Do not alter, open, or delete any files or programs until the system restoration is complete.

1. Click the **Start** button, point to **All Programs**→**Accessories**→**System Tools**, and then click **System Restore**.
2. Ensure that **Restore my computer to an earlier time** is selected, and then click **Next**.
3. Click a calendar date to which you want to restore your computer.

The **Select a Restore Point** screen provides a calendar that allows you to see and select restore points. All calendar dates with available restore points appear in bold.

4. Select a restore point, and then click **Next**.

If a calendar date has only one restore point, then that restore point is automatically selected. If two or more restore points are available, click the restore point that you prefer.

5. Click **Next**.

The **Restoration Complete** screen appears after System Restore finishes collecting data, and then the computer automatically restarts.

6. After the computer restarts, click **OK**.

To change the restore point, you can either repeat the steps using a different restore point, or you can undo the restoration.

Undoing the Last System Restore

 **NOTICE:** Before undoing the last system restore, save and close all open files and close all open programs. Do not alter, open, or delete any files or programs until the system restoration is complete.

1. Click the **Start** button, point to **All Programs**→**Accessories**→**System Tools**, and then click **System Restore**.
2. Select **Undo my last restoration** and click **Next**.
3. Click **Next**.

The System Restore screen appears, and then the computer automatically restarts.

4. After the computer restarts, click **OK**.

Enabling System Restore

If you reinstall Windows XP with less than 200 MB of free hard-disk space available, System Restore is automatically disabled. To see if System Restore is enabled:

1. Click the **Start** button, and then click **Control Panel**.
2. Click **Performance and Maintenance**.
3. Click **System**.
4. Click the **System Restore** tab.
5. Make sure that **Turn off System Restore** is unchecked.

Drivers

What Is a Driver?

A driver is a program that controls a device such as a printer, mouse, or keyboard. All devices require a driver program.

A driver acts like a translator between the device and the programs that use the device. Each device has its own set of specialized commands that only its driver recognizes.

Many drivers such as the keyboard driver come with your Microsoft® Windows® operating system. You may need to install drivers if:

- 1 You upgrade your operating system.
- 1 You reinstall your operating system.
- 1 You connect or install a new device.

If you experience a problem with any device, perform the steps in the following sections to identify whether the driver is the source of your problem and to update the driver, if necessary.

Identifying Drivers

1. Click the **Start** button and click **Control Panel**.
2. In the **Control Panel** window, under **Pick a Category**, click **Performance and Maintenance**.
3. In the **Performance and Maintenance** window, click **System**.
4. In the **System Properties** screen, click the **Hardware** tab.
5. Click **Device Manager**.
6. In the **Device Manager** window, scroll down the list to see if any device has an exclamation point (a yellow circle with a [!]) on the device icon.

If an exclamation point is next to the device name, you may need to reinstall the driver or install a new driver.

Reinstalling Drivers

 **NOTICE:** The Dell Support [website](#) and your *Dell Dimension ResourceCD* provide approved drivers for Dell™ computers. If you install drivers obtained from other sources, your computer might not work correctly.

Using Windows XP Device Driver Rollback

If a problem occurs on your computer after you install or update a driver, use Windows XP Device Driver Rollback or to replace the driver with the previously installed version.

To use Device Driver Rollback:

1. Click the **Start** button and click **Control Panel**.
2. In the **Control Panel** window, under **Pick a Category**, click **Performance and Maintenance**.
3. In the **Performance and Maintenance** window, click **System**.
4. In the **System Properties** screen, click the **Hardware** tab.
5. Click **Device Manager**.
6. In the **Device Manager** window, right-click the device for which the new driver was installed, and then click **Properties**.
7. Click the **Drivers** tab.
8. Click **Roll Back Driver**.

If Device Driver Rollback does not resolve the problem, then use [System Restore](#) to return your operating system to the operating state it was in before you installed the new driver.

Using the Dell Dimension ResourceCD

If using [Device Driver Rollback](#) or [System Restore](#) does not resolve the problem, then reinstall the driver from the *Dell Dimension ResourceCD*:

1. With the Windows desktop displayed, insert the ResourceCD into the CD or DVD drive.
If this is your first time to use the ResourceCD, go to [step 2](#). If not, go to [step 5](#).
2. When the ResourceCD installation program starts, follow the prompts on the screen.
3. When the **InstallShield Wizard Complete** window appears, remove the ResourceCD and click **Finish** to restart the computer.
4. When you see the Windows desktop, reinsert the ResourceCD into the CD or DVD drive.
5. At the **Welcome Dell System Owner** screen, click **Next**.

 **HINT:** The ResourceCD displays drivers only for hardware that came on your computer. If you installed additional hardware, those drivers might not be displayed by the ResourceCD. If those drivers are not displayed, exit the ResourceCD program. For drivers information, see the documentation that came with that product.

A message stating that the ResourceCD is detecting hardware in your computer appears.

The drivers that are used by your computer are automatically displayed in the **My Drivers—The ResourceCD has identified these components in your system** window.

6. Click the driver that you want to reinstall and follow the instructions on the screen.

If a particular driver is not listed, then that driver is not required by your operating system.

Resolving Software and Hardware Incompatibilities

Microsoft® Windows® XP IRQ conflicts occur if a device either is not detected during the operating system setup or is detected but incorrectly configured.

To check for conflicts on a computer running Windows XP:

1. Click the **Start** button, and then click **Control Panel**.
2. Click **Performance and Maintenance**, and then click **System**.
3. Click the **Hardware** tab, and then click **Device Manager**.
4. In the **Device Manager** list, check for conflicts with the other devices.

Conflicts are indicated by a yellow exclamation point (!) beside the conflicting device or a red x if the device has been disabled.

5. Double-click any conflicting device listed to bring up the **Properties** window to determine what needs to be reconfigured or removed from the Device Manager.

Resolve these conflicts before checking specific devices.

6. Double-click the malfunctioning device type in the **Device Manager** list.
7. Double-click the icon for the specific device in the expanded list.

The **Properties** window appears.

8. Resolve any IRQ conflicts, as described in [step 5](#).

If an IRQ conflict exists, the **Device** status area in the **Properties** window reports the cards or devices that share the device's IRQ.

You can also use the Windows XP Hardware Troubleshooter:

1. Click the **Start** button.
2. Click **Help and Support**.
3. Type `hardware troubleshooter` in the **Search** field, and then click the arrow to start the search.
4. Click **Hardware Troubleshooter** in the **Search Results** list.
5. In the **Hardware Troubleshooter** list, click **I need to resolve a hardware conflict on my computer**.
6. Click **Next**.

Reinstalling Microsoft® Windows® XP

Before You Reinstall

If you are reinstalling the Windows XP operating system to correct a problem with a newly installed driver, use Windows XP [Device Driver Rollback](#) to replace the device driver with the previously installed version.

If Device Driver Rollback does not resolve the problem, then use [System Restore](#) to return your operating system to the operating state it was in before you installed the new device driver.

Reinstalling Windows XP

To reinstall Windows XP, perform the steps in the following sections in the order in which they are listed.

The reinstallation process can take 1 to 2 hours to complete. After the reinstallation is complete, you will need to reinstall the device drivers, virus protection program, and other software.

- 🔔 **NOTICE:** The *Operating System CD* provides options for reinstalling Windows XP. The options can overwrite files and possibly affect programs installed on your hard drive. Therefore, do not reinstall Windows XP unless instructed to do so by a Dell technical support representative.
- 🔔 **NOTICE:** To prevent conflicts with Windows XP, disable any virus protection software installed on your computer before you reinstall Windows XP. See the documentation that came with the software for instructions.

Preparing to Boot From the Operating System CD

1. Insert the *Operating System CD* into the CD or DVD drive.
2. Exit any program or utility that might run after you insert the CD.
3. [Shut down](#) and restart the computer.
4. Press <F12> immediately after the Dell™ logo appears.

If the operating system logo appears, wait until you see the Windows desktop, and then shut down the computer and try again.

5. Use the arrow keys to select CD-ROM, and then press <Enter>.
6. Press any key when the `Press any key to boot from CD` message appears on the screen.

Starting Windows XP Setup

1. When the **Windows XP Setup** screen appears, press <Enter> to select **To set up Windows now**.
2. Read the information in the **Microsoft Windows Licensing Agreement** screen, and then press <F8> on your keyboard to accept the license agreement.

3. If your computer already has Windows XP installed and you want to recover your current Windows XP data, type `r` to select the repair option, and then remove the CD from the drive.
4. If you want to install a new copy of Windows XP, press `<Esc>` to select the fresh copy option.
5. Press `<Enter>` to select the highlighted partition (recommended), and then follow the instructions on the screen.

 **HINT:** The time required to complete the setup depends on the size of the hard drive and the speed of your computer. You can step away from the computer at this time if you need to do so.

The **Windows XP Setup** screen appears, and the operating system begins to copy files and install the devices. The computer automatically restarts multiple times.

Completing the GUI Setup

 **NOTICE:** When the computer restarts, you will see the following message: `Press any key to boot from the CD.` Do not press any key when this message appears.

1. When the **Regional and Language Options** screen appears, select the settings for your location, and then click **Next**.
2. Enter your name and organization (optional) in the **Personalize Your Software** screen, and then click **Next**.
3. *If you are reinstalling Windows XP Home Edition*, at the **What's your computer's name** window, enter a name for your computer (or accept the name provided), and then click **Next**.

If you are reinstalling Windows XP Professional, at the **Computer Name and Administrator Password** window, enter a name for your computer (or accept the one provided) and a password, and then click **Next**.

4. If your computer has a modem installed, the **Modem Dialing Information** screen appears. Enter the requested information and click **Next**.
5. Enter the date, time, and time zone in the **Date and Time Settings** window and click **Next**.
6. *If your computer has a network adapter*, select **Typical** in the **Networking Settings** screen and click **Next**.
If your computer does not have a network adapter, you do not see this option.
7. If you are reinstalling Windows XP Professional, you may be prompted to provide further network information regarding your network configuration, such as the domain name or workgroup name. If you are unsure of your settings, accept the default selections.

Windows XP installs the operating system components and configures the computer. The computer automatically restarts.

Completing the Operating System Setup

 **NOTICE:** When the computer restarts, you will see the following message: `Press any key to boot from the CD.` Do not press any key when this message appears.

1. When the Welcome to Microsoft screen appears, click **Next**.
2. When the **How will this computer connect to the Internet?** message appears, click **Skip**.
3. When the **Ready to register with Microsoft?** screen appears, select **No, not at this time**, and then click **Next**.
4. When the **Who will use this computer?** screen appears, you can enter up to five users.
5. Click **Next**.
6. Click **Finish** to complete the setup, and remove the CD from the drive.

Reinstalling Drivers and Software





1. [Reinstall the appropriate drivers.](#)
2. Reinstall your virus protection software. See the documentation that came with the software for instructions.
3. Reinstall your other software programs. See the documentation that came with the software for instructions.

Documentation

Dell™ Dimension™ 2300

- [Finding Information for Your Computer](#)
- [Printed Documentation](#)
- [Online Documentation](#)

Finding Information for Your Computer

What Are You Looking For?	Find it Here
<ul style="list-style-type: none"> 1 A diagnostic program for my computer 1 Drivers for my computer 1 My computer documentation 1 My device documentation 	<p>ResourceCD</p>  <p>You can use this CD to access documentation or reinstall drivers</p>
<ul style="list-style-type: none"> 1 How to set up a printer 1 How to troubleshoot and solve problems 1 How to add parts 1 How to contact Dell 	<p>Owner's Manual</p> 
<ul style="list-style-type: none"> 1 Express Service Code and Service Tag Number 1 Microsoft® Windows® License Label 	<p>Express Service Code and Product Key</p>  <p>Located on your computer.</p>
<ul style="list-style-type: none"> 1 How to reinstall my operating system 	<p>Operating System CD</p>  <p>If you reinstall your operating system, use the ResourceCD to reinstall drivers for the devices that came with your computer.</p>
<ul style="list-style-type: none"> 1 Latest drivers for my computer 1 Answers to technical service and support questions 1 Online discussions with other users and technical support 1 Documentation for my computer 	<p>Dell Support website</p> <p>support.dell.com</p> <p>The Dell Support website provides several online tools, including:</p> <ul style="list-style-type: none"> 1 Knowledge Base — hints, tips, and online courses 1 Customer Forum — online discussion with other Dell customers 1 Upgrades — upgrade information for components, such as memory, the hard drive, and the operating system 1 Customer Care — contact information, order status, warranty, and repair information 1 Downloads — drivers, patches, and software updates

	1 Reference — computer documentation, product specifications, and white papers
1 How to set up my computer	<p>Start Here setup diagram</p> 
1 Tips on using Windows 1 How to clean my computer 1 How to use my mouse and keyboard	<p>Tell Me How Help File</p> <ol style="list-style-type: none"> 1. Click the Start button, and then click Help and Support. 2. Click User and system guides, and then click User's guides. 3. Click Tell Me How.
1 How to use Windows XP 1 Documentation for my computer and devices	<p>Windows XP Help and Support Center</p> <ol style="list-style-type: none"> 1. Click the Start button, and then click Help and Support. 2. Type a word or phrase that describes your problem, and then click the arrow icon. 3. Click the topic that describes your problem. 4. Follow the instructions shown on the screen.

Printed Documentation

 **HINT:** You must right-click the link for a portable document format (PDF) file and save the file to your hard drive. Attempting to open large PDF files through your browser causes your computer to freeze.

To save PDF files (files with an extension of **.pdf**) to your hard drive, right-click the document title, click **Save Target As** in Microsoft® Internet Explorer or **Save Link As** in Netscape Navigator, and specify a location on your hard drive.

Right-click only the following links:

[Dell Dimension 2300 Owner's Manual \(.pdf\) \(1.56 MB\)](#) — Provides information on adding upgrades, performing basic troubleshooting procedures, and reinstalling drivers. It also provides technical specifications.

[Start Here setup diagram \(.pdf\) \(3.12 MB\)](#) — Provides information on how to set up your computer.

Online Documentation

 **HINT:** PDF files require Adobe™ Acrobat Reader, which can be downloaded from the Adobe World Wide Web site at www.adobe.com/acrobat/. To view a PDF file, launch Acrobat Reader. Click **File→Open** and select the PDF file.

The *Tell Me How* help file is already loaded on your hard drive when you receive your computer. To open the file:

1. Click the **Start** button, and then click **Help and Support**.
2. Click **User and system guides**, and then click **User's guides**.
3. Click **Tell Me How**.

 **HINT:** *Tell Me How* help files (files with an extension of **.chm**) require Microsoft Internet Explorer 4.0 or later.

The *Tell Me How* help file allows you to search for information in multiple ways. You can quickly link to information on the following topics:

- 1 Hardware and software features of your computer
- 1 The Windows desktop, where you can change your wallpaper and screen saver, create shortcuts, and position icons
- 1 Software access, installation, and removal
- 1 Basic file management, such as finding, copying, deleting, and renaming files
- 1 Tips on using your computer hardware

Downloading the *Tell Me How* Help File and Associated Files

1. Right-click the following link to the **hhactivex.dll** file: [hhactivex.dll](#).

2. Click **Save Target As** in Microsoft Internet Explorer or **Save Link As** in Netscape Navigator, and specify `c:\windows\system`.
3. Click the **Start** button on the Microsoft Windows desktop, and then click **Run**.
4. Type `regsvr32 hhactivex.dll` and then press <Enter>.
5. Click **OK** when the installation is complete.
6. Right-click the following link to the file: [Dell Dimension 2300 Tell Me How \(.chm\) \(578 KB\)](#).
7. Click **Save Target As** in Microsoft Internet Explorer or **Save Link As** in Netscape Navigator, and specify a location on your hard drive.

Viewing the *Tell Me How* Help File

1. Click the **Start** button on the Windows desktop, point to **All Programs**→**Accessories**, and then click **Windows Explorer**.
2. Navigate to the directory in which you saved the *Tell Me How* help file.
3. Double-click the file (`tellhow.chm`).

[Back to Contents Page](#)

Adding and Replacing Parts

Dell™ Dimension™ 2300

- [Shutting Down the Computer](#)
- [Removing the Computer Cover](#)
- [Looking Inside Your Computer](#)
- [Adding or Removing Cards](#)
- [Adding Memory](#)
- [Removing the Front Panel](#)
- [Removing the Front-Panel Insert](#)
- [Hard Drive](#)
- [Floppy Drive](#)
- [Replacing the CD/DVD Drive](#)
- [Adding a Second CD/DVD Drive](#)
- [Replacing the Microprocessor](#)
- [Replacing the System Board](#)
- [Replacing the Power Supply](#)
- [Replacing the Battery](#)
- [Replacing the Computer Cover](#)

Shutting Down the Computer

 **NOTICE:** To prevent data loss, you must turn off your computer through the **Start** menu instead of by pressing the power button.

 **HINT:** If you are having difficulty turning off your computer, see "[General Problems](#)."

1. Save and close any open files and exit any open programs.
2. Click the **Start** button and then click **Turn off Computer**.
3. Click **Turn off**.

The computer automatically turns off after the shutdown process finishes.

4. Turn off your monitor and any other devices connected to power.
-

Removing the Computer Cover

 **CAUTION:** Before you begin any of the procedures in this section, follow the safety instructions provided in your *Owner's Manual*.

 **CAUTION:** To guard against electrical shock, always unplug your computer from the electrical outlet before opening the cover.

1. [Shut down the computer](#) through the **Start** menu.
2. Ensure that your computer and attached devices are turned off. If your computer and attached devices did not automatically turn off when you shut down your computer, turn them off now.

 **NOTICE:** To disconnect a network cable, first unplug the cable from your computer and then unplug it from the network wall jack.

3. Disconnect any telephone or telecommunication lines from the computer.
4. Disconnect your computer and all attached devices from their electrical outlets, and then press the power button to ground the system board.

 **CAUTION:** To guard against electrical shock, always unplug your computer from the electrical outlet before opening the cover.

 **NOTICE:** Before touching anything inside your computer, ground yourself by touching an unpainted metal surface, such as the metal at the back of the computer. While you work, periodically touch an unpainted metal surface to dissipate any static electricity that could harm internal components.

5. Loosen the thumbscrew.
6. Push down on the cover button.
7. Grip the indent in the middle of the computer cover, and slide the computer cover towards the back of the computer.

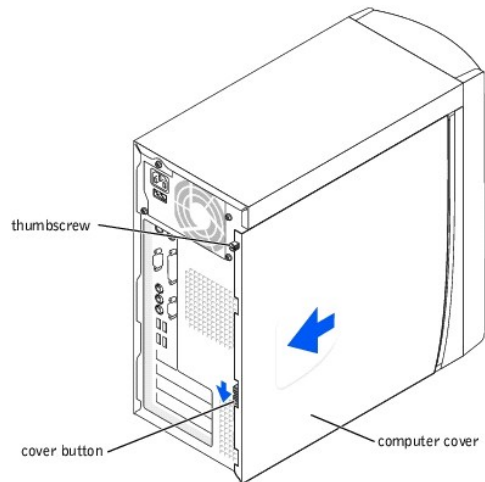

8. Place the computer cover on a level surface.

Looking Inside Your Computer

- ⚠ **CAUTION:** Before you begin any of the procedures in this section, follow the safety instructions provided in your *Owner's Manual*.
- ⚠ **CAUTION:** To guard against electrical shock, always unplug your computer from the electrical outlet before opening the cover.

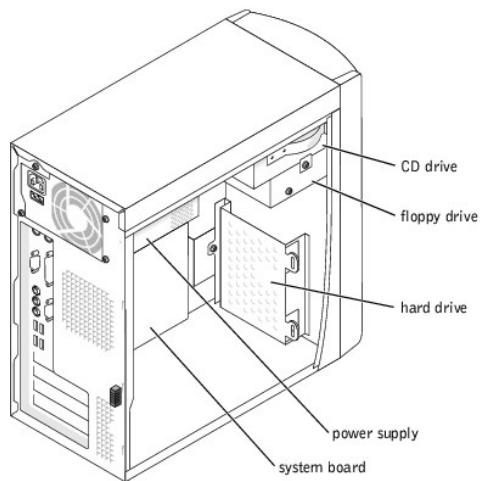

Adding or Removing Cards

- ⚠ **CAUTION:** Before you begin any of the procedures in this section, follow the safety instructions provided in your *Owner's Manual*.
- ⚠ **CAUTION:** To guard against electrical shock, always unplug your computer from the electrical outlet before opening the cover.

1. [Shut down the computer](#) through the **Start** menu.
2. Ensure that your computer and attached devices are turned off. If your computer and attached devices did not automatically turn off when you shut down your computer, turn them off now.

🔌 **NOTICE:** To disconnect a network cable, first unplug the cable from your computer and then unplug it from the network wall jack.

3. Disconnect any telephone or telecommunication lines from the computer.
4. Disconnect your computer and all attached devices from their electrical outlets, and then press the power button to ground the system board.

⚠ CAUTION: To guard against electrical shock, always unplug your computer from the electrical outlet before opening the cover.

5. [Remove the computer cover.](#)

🔧 NOTICE: Before touching anything inside your computer, ground yourself by touching an unpainted metal surface, such as the metal at the back of the computer. While you work, periodically touch an unpainted metal surface to dissipate any static electricity that could harm internal components.

6. Lay the computer on its side so that the system board is on the bottom of the inside of the computer.

7. Unscrew and remove the filler bracket for the card slot you want to use.

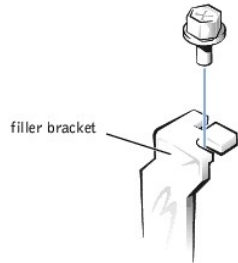

⚠ CAUTION: Some network adapters automatically start the computer when they are connected to a network. To guard against electrical shock, be sure to unplug your computer from its electrical outlet before installing any cards.

8. Align the cutout on the bottom of the card with the crossbar in the system board connector. Gently rock the card into the connector until it is fully seated.

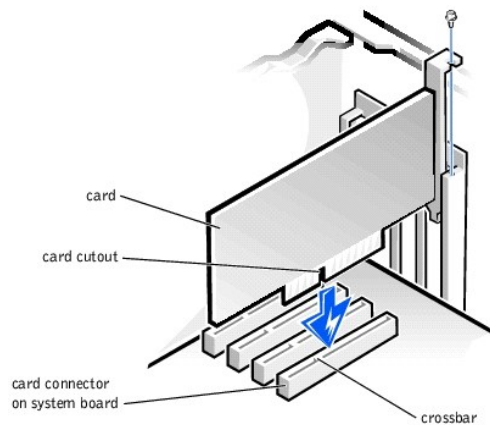

Ensure that the card is fully seated and that its bracket is within the card slot.

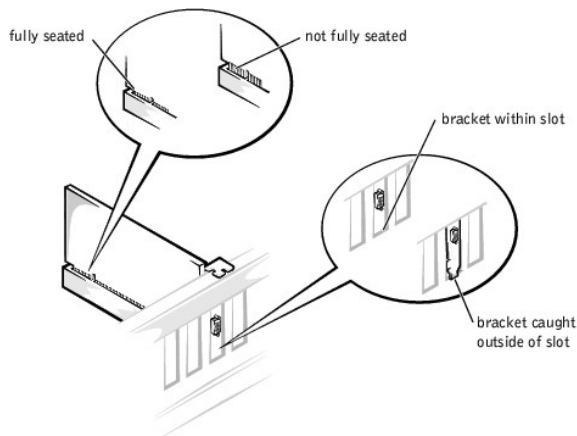

9. Secure the bracket on the end of the card with the screw you removed in [step 7](#).
10. Connect any cables required for the card as described in the card documentation.

 **NOTICE:** Do not route card cables over or behind the cards. Cables routed over the cards can cause damage to the equipment.

11. [Replace the computer cover](#).

 **NOTICE:** To connect a network cable, first plug the cable into the network wall jack and then plug it into the computer.

12. Connect your computer and devices to electrical outlets, and turn them on.
13. Install any drivers required for the card as described in the card documentation.

Removing Cards

 **CAUTION:** Before you begin any of the procedures in this section, follow the safety instructions provided in your *Owner's Manual*.

 **CAUTION:** To guard against electrical shock, always unplug your computer from the electrical outlet before opening the cover.

1. [Shut down the computer](#) through the **Start** menu.
2. Ensure that your computer and attached devices are turned off. If your computer and attached devices did not automatically turn off when you shut down your computer, turn them off now.

 **NOTICE:** To disconnect a network cable, first unplug the cable from your computer and then unplug it from the network wall jack.

3. Disconnect any telephone or telecommunication lines from the computer.
4. Disconnect your computer and all attached devices from their electrical outlets, and then press the power button to ground the system board.

 **CAUTION:** To guard against electrical shock, always unplug your computer from the electrical outlet before opening the cover.

5. [Remove the computer cover](#).

 **NOTICE:** Before touching anything inside your computer, ground yourself by touching an unpainted metal surface, such as the metal at the back of the computer. While you work, periodically touch an unpainted metal surface to dissipate any static electricity that could harm internal components.

6. Lay the computer on its side so that the system board is on the bottom of the inside of the computer.
7. Disconnect any cables connected to the card.
8. Remove the screw from the card bracket.
9. Grasp the card by its top corners, and lift it from the system board.
10. If you are removing the card permanently, reinstall a filler bracket.
11. [Replace the computer cover](#).

 **NOTICE:** To connect a network cable, first plug the cable into the network wall jack and then plug it into the computer.

12. Connect your computer and devices to electrical outlets, and turn them on.
-

Adding Memory

 **CAUTION:** Before you begin any of the procedures in this section, follow the safety instructions provided in your *Owner's Manual*.

 **CAUTION:** To guard against electrical shock, always unplug your computer from the electrical outlet before opening the cover.

You can increase your computer memory by installing memory modules on the system board. For information on the type of memory supported by your computer, look under "[Memory](#)" in "Technical Specifications."

 **HINT:** Memory purchased from Dell is covered under your computer warranty.

1. [Shut down the computer](#) through the **Start** menu.
2. Ensure that your computer and attached devices are turned off. If your computer and attached devices did not automatically turn off when you shut down your computer, turn them off now.

 **NOTICE:** To disconnect a network cable, first unplug the cable from your computer and then unplug it from the network wall jack.

3. Disconnect any telephone or telecommunication lines from the computer.
4. Disconnect your computer and all attached devices from their electrical outlets, and then press the power button to ground the system board.

CAUTION: To guard against electrical shock, always unplug your computer from the electrical outlet before opening the cover.

5. [Remove the computer cover.](#)

NOTICE: Before touching anything inside your computer, ground yourself by touching an unpainted metal surface, such as the metal at the back of the computer. While you work, periodically touch an unpainted metal surface to dissipate any static electricity that could harm internal components.

6. Lay the computer on its side so that the system board is on the bottom of the inside of the computer.

7. If necessary, remove a memory module:

- Press out the securing clip at each end of the memory module connector.
- Grasp the module and pull up.

If the module is difficult to remove, gently ease the module back and forth to remove it from the connector.

8. To insert a module, press out the securing clip at each end of the memory module connector.

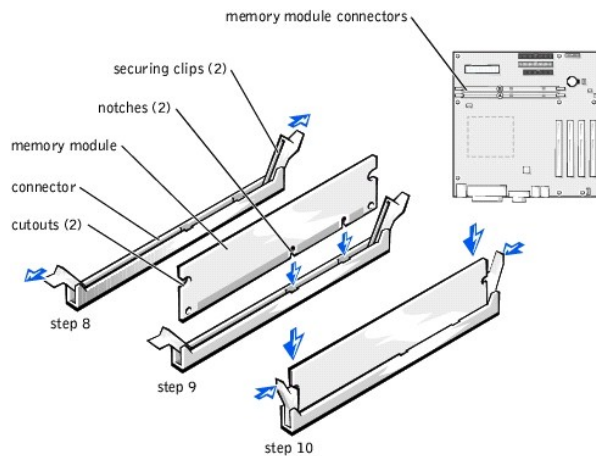

9. Align the notches on the bottom of the module with the crossbars in the connector.

NOTICE: To avoid breaking the memory module, do not press near the middle of the module.

10. Insert the module straight down into the connector, ensuring that it fits into the vertical guides at each end of the connector. Press firmly on the ends of the module until it snaps into place.

If you insert the module correctly, the securing clips snap into the cutouts at each end of the module.

11. [Close the computer cover.](#)

NOTICE: To connect a network cable, first plug the cable into the network wall jack and then plug it into the computer.

12. Connect your computer and devices to electrical outlets, and turn them on.

13. Click the **Start** button, right-click **My Computer**, and then click **Properties**.

14. Click the **General** tab.

HINT: The system memory value reported by the operating system will be slightly less than the memory installed because some memory is reserved for video functions.

15. To verify that the memory is installed correctly, check the amount of memory (RAM) listed.

Removing the Front Panel

CAUTION: Before you begin any of the procedures in this section, follow the safety instructions provided in your *Owner's Manual*.

CAUTION: To guard against electrical shock, always unplug your computer from the electrical outlet before opening the cover.

1. [Shut down the computer](#) through the **Start** menu.

2. Ensure that your computer and attached devices are turned off. If your computer and attached devices did not automatically turn off when you shut down your computer, turn them off now.

➡ **NOTICE:** To disconnect a network cable, first unplug the cable from your computer and then unplug it from the network wall jack.

3. Disconnect any telephone or telecommunication lines from the computer.

4. Disconnect your computer and all attached devices from their electrical outlets, and then press the power button to ground the system board.

⚠ **CAUTION:** To guard against electrical shock, always unplug your computer from the electrical outlet before opening the cover.

5. [Remove the computer cover.](#)

➡ **NOTICE:** Before touching anything inside your computer, ground yourself by touching an unpainted metal surface, such as the metal at the back of the computer. While you work, periodically touch an unpainted metal surface to dissipate any static electricity that could harm internal components.

6. Release and remove the front panel:

- a. Push the release lever to release both the top tab and the middle tab.
- b. Reach inside the computer and push the bottom tab towards you to release it.
- c. Rotate the front panel to separate it from the side hinges.

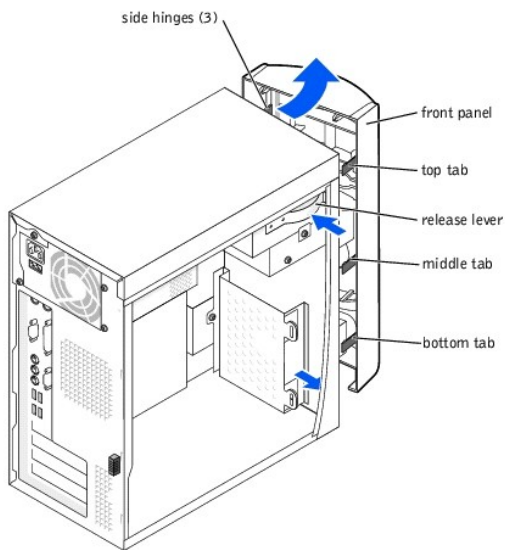

To reattach the front panel, attach the side hinges and then rotate the front panel until it snaps onto the front of the computer.

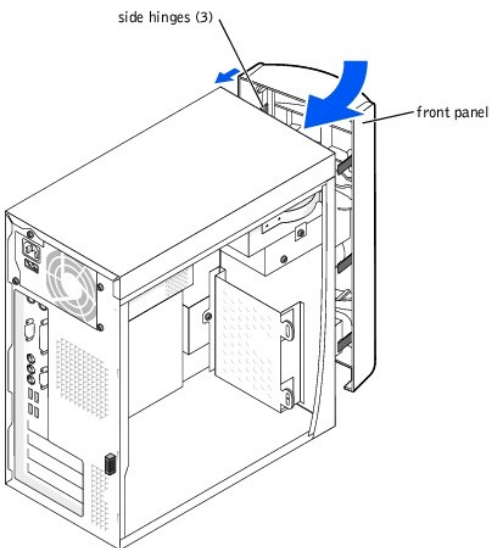

Removing the Front-Panel Insert

⚠ CAUTION: Before you begin any of the procedures in this section, follow the safety instructions provided in your *Owner's Manual*.

⚠ CAUTION: To guard against electrical shock, always unplug your computer from the electrical outlet before opening the cover.

1. [Shut down the computer](#) through the **Start** menu.
2. Ensure that your computer and attached devices are turned off. If your computer and attached devices did not automatically turn off when you shut down your computer, turn them off now.

➡ NOTICE: To disconnect a network cable, first unplug the cable from your computer and then unplug it from the network wall jack.

3. Disconnect any telephone or telecommunication lines from the computer.
4. Disconnect your computer and all attached devices from their electrical outlets, and then press the power button to ground the system board.

⚠ CAUTION: To guard against electrical shock, always unplug your computer from the electrical outlet before opening the cover.

5. [Remove the computer cover](#).

➡ NOTICE: Before touching anything inside your computer, ground yourself by touching an unpainted metal surface, such as the metal at the back of the computer. While you work, periodically touch an unpainted metal surface to dissipate any static electricity that could harm internal components.

6. [Remove the front panel](#).
7. Pull the two front-panel tabs towards you, and then push out the front-panel insert.

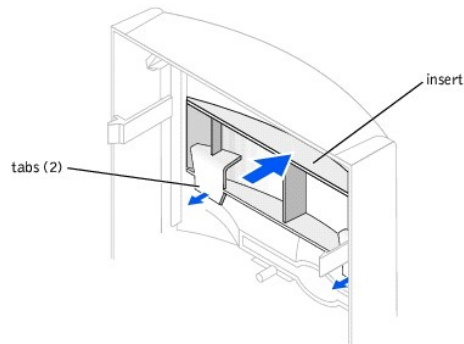

Hard Drive

⚠ CAUTION: Before you begin any of the procedures in this section, follow the safety instructions provided in your *Owner's Manual*.

⚠ CAUTION: To guard against electrical shock, always unplug your computer from the electrical outlet before opening the cover.

⚠ CAUTION: To avoid damage to the drive, do not set it on a hard surface. Instead, set the drive on a soft surface, such as a foam pad, that will sufficiently cushion it.

1. [Shut down the computer](#) through the **Start** menu.
2. Ensure that your computer and attached devices are turned off. If your computer and attached devices did not automatically turn off when you shut down your computer, turn them off now.

➡ NOTICE: To disconnect a network cable, first unplug the cable from your computer and then unplug it from the network wall jack.

3. Disconnect any telephone or telecommunication lines from the computer.
4. Disconnect your computer and all attached devices from their electrical outlets, and then press the power button to ground the system board.

⚠ CAUTION: To guard against electrical shock, always unplug your computer from the electrical outlet before opening the cover.

5. [Remove the computer cover](#).

➡ NOTICE: Before touching anything inside your computer, ground yourself by touching an unpainted metal surface, such as the metal at the back of the computer. While you work, periodically touch an unpainted metal surface to dissipate any static electricity that could harm internal components.

6. Remove the bracket-securing screw, and then remove the drive bracket from the computer.
7. Remove the hard drive-securing screw, and then remove the hard drive from the bracket.

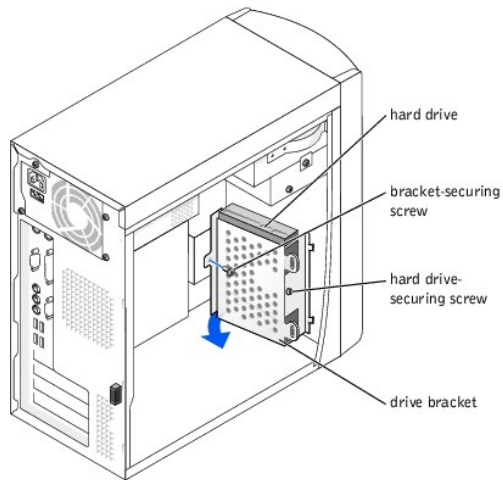

☛ **NOTICE:** Ground yourself by touching an unpainted metal surface on the back of the computer.

☛ **NOTICE:** When you unpack the drive, do not set it on a hard surface, which may damage the drive. Instead, set the drive on a soft surface, such as a foam pad, that will sufficiently cushion it.

8. Unpack the replacement hard drive.
9. Check the jumper setting on the back of the replacement drive.

Ensure that the jumper setting on the new device is set for "cable select" (see the documentation that came with the drive for information).

10. Install the new hard drive in the bracket.

Place the hard drive in the bracket so that the two screw-hole tabs insert into the two screw holes on the hard drive, and then secure the drive to the bracket with the screw that you removed in [step 7](#).

11. Install the bracket into the computer.

Place the two bracket tabs into the drive slots inside the computer's front panel, swing the bracket forward so that it flush with the computer's front panel, and then replace the bracket-securing screw that you removed in [step 6](#).

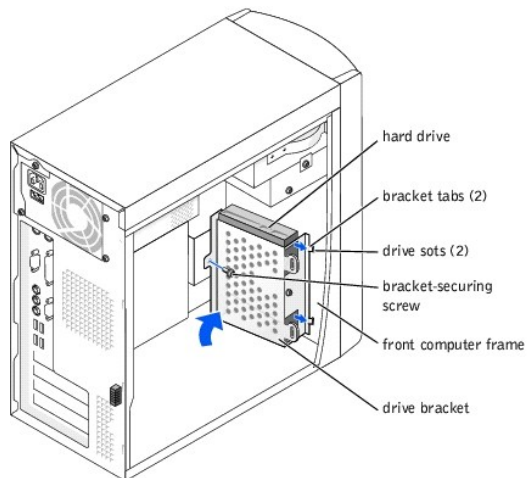

⚠ **CAUTION:** Match the colored strip on the cable with pin 1 on the drive (pin 1 is marked as "1").

12. Connect the power and data cables to the back of the replacement drive.
13. [Replace the computer cover.](#)

☛ **NOTICE:** To connect a network cable, first plug the cable into the network wall jack and then plug it into the computer.

14. Connect your computer and devices to electrical outlets, and turn them on.
15. See the documentation that came with the drive for instructions on installing any software required for drive operation.

Floppy Drive

⚠ CAUTION: Before you begin any of the procedures in this section, follow the safety instructions provided in your *Owner's Manual*.

⚠ CAUTION: To guard against electrical shock, always unplug your computer from the electrical outlet before opening the cover.

1. [Shut down the computer](#) through the **Start** menu.
2. Ensure that your computer and attached devices are turned off. If your computer and attached devices did not automatically turn off when you shut down your computer, turn them off now.

➡ NOTICE: To disconnect a network cable, first unplug the cable from your computer and then unplug it from the network wall jack.

3. Disconnect any telephone or telecommunication lines from the computer.
4. Disconnect your computer and all attached devices from their electrical outlets, and then press the power button to ground the system board.

⚠ CAUTION: To guard against electrical shock, always unplug your computer from the electrical outlet before opening the cover.

5. [Remove the computer cover](#).

➡ NOTICE: Before touching anything inside your computer, ground yourself by touching an unpainted metal surface, such as the metal at the back of the computer. While you work, periodically touch an unpainted metal surface to dissipate any static electricity that could harm internal components.

6. Remove the top bracket screw.

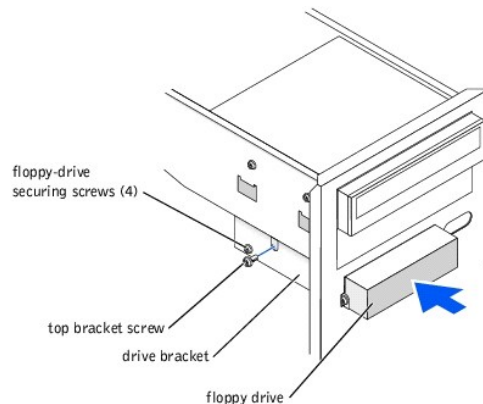

7. Slide the drive bracket backward approximately one-half inch, and then remove it from the computer.
8. Disconnect the power and data cables from the back of the floppy drive.
9. Remove the four floppy-drive securing screws and remove the drive.
10. Place the new drive in the drive bracket and secure it with the four floppy-drive securing screws.

⚠ CAUTION: Match the colored strip on the cable with pin 1 on the drive (pin 1 is marked as "1").

11. Reconnect the power and data cables to the back of the drive.
12. Position the top of the floppy drive bracket so that it is completely flush with the bottom of the upper drive bay, and then slide the floppy drive bracket forward into place.

The top of the floppy drive bracket has two slots that fit into two clips on the bottom of the upper drive bay. When the floppy drive bracket is properly mounted, it remains in place without support.

13. Secure the floppy drive bracket with the top bracket screw that you removed in [step 6](#).
14. Check all cable connections, and fold cables out of the way to provide airflow for the fan and cooling vents.
15. [Replace the computer cover](#).

➡ NOTICE: To connect a network cable, first plug the cable into the network wall jack and then plug it into the computer.

16. Connect your computer and devices to electrical outlets, and turn them on.

17. See the documentation that came with the drive for instructions on installing any software required for drive operation.

Replacing the CD/DVD Drive

⚠ CAUTION: Before you begin any of the procedures in this section, follow the safety instructions provided in your *Owner's Manual*.

⚠ CAUTION: To guard against electrical shock, always unplug your computer from the electrical outlet before opening the cover.

🔧 HINT: Drives sold by Dell come with their own operating software and documentation. After you install a drive, see the documentation that came with the drive for instructions on installing and using the drive software.

1. [Shut down the computer](#) through the **Start** menu.
2. Ensure that your computer and attached devices are turned off. If your computer and attached devices did not automatically turn off when you shut down your computer, turn them off now.

🔌 NOTICE: To disconnect a network cable, first unplug the cable from your computer and then unplug it from the network wall jack.

3. Disconnect any telephone or telecommunication lines from the computer.
4. Disconnect your computer and all attached devices from their electrical outlets, and then press the power button to ground the system board.

⚠ CAUTION: To guard against electrical shock, always unplug your computer from the electrical outlet before opening the cover.

5. [Remove the computer cover](#).

🔌 NOTICE: Before touching anything inside your computer, ground yourself by touching an unpainted metal surface, such as the metal at the back of the computer. While you work, periodically touch an unpainted metal surface to dissipate any static electricity that could harm internal components.

6. [Remove the front panel](#).
7. Remove the power and drive cables from the back of the drive.
8. Remove the securing screw, and then slide the drive forward and remove it from the computer.
9. Remove the two alignment screws from the drive, and then install them into the same screw holes on the new drive.

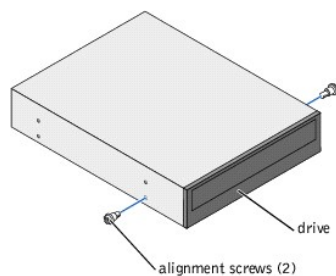

10. Ensure that the jumper setting on the new drive is set for "cable select" (see the documentation that came with the drive for information).
11. Gently slide the drive into place.
12. Once the drive is in place, apply pressure to ensure the drive is fully seated.
13. Use the securing screw that came with the drive to attach the drive to the computer.

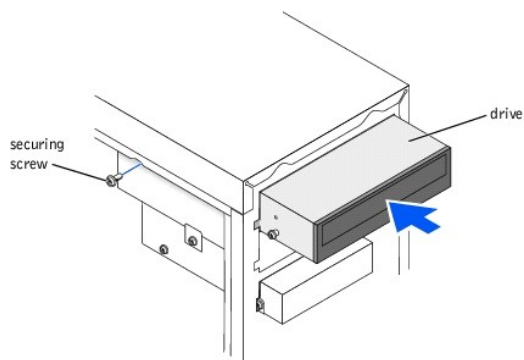

⚠ CAUTION: Match the colored strip on the cable with pin 1 on the drive (pin 1 is marked as "1").

14. Connect the power and data cables to the new drive.
15. Check all cable connections, and fold cables out of the way to provide airflow for the fan and cooling vents.
16. [Replace the front panel.](#)
17. [Replace the computer cover.](#)

➡ NOTICE: To connect a network cable, first plug the cable into the network wall jack and then plug it into the computer.

18. Connect your computer and devices to electrical outlets, and turn them on.
19. See the documentation that came with the drive for instructions on installing any software required for drive operation.

Adding a Second CD/DVD Drive

⚠ CAUTION: Before you begin any of the procedures in this section, follow the safety instructions provided in your *Owner's Manual*.

⚠ CAUTION: To guard against electrical shock, always unplug your computer from the electrical outlet before opening the cover.

🔍 HINT: Drives sold by Dell come with their own operating software and documentation. After you install a drive, see the documentation that came with the drive for instructions on installing and using the drive software.

1. [Shut down the computer](#) through the **Start** menu.
2. Ensure that your computer and attached devices are turned off. If your computer and attached devices did not automatically turn off when you shut down your computer, turn them off now.

➡ NOTICE: To disconnect a network cable, first unplug the cable from your computer and then unplug it from the network wall jack.

3. Disconnect any telephone or telecommunication lines from the computer.
4. Disconnect your computer and all attached devices from their electrical outlets, and then press the power button to ground the system board.

⚠ CAUTION: To guard against electrical shock, always unplug your computer from the electrical outlet before opening the cover.

5. [Remove the computer cover.](#)

➡ NOTICE: Before touching anything inside your computer, ground yourself by touching an unpainted metal surface, such as the metal at the back of the computer. While you work, periodically touch an unpainted metal surface to dissipate any static electricity that could harm internal components.

6. [Remove the front panel.](#)
7. [Remove the front-panel insert.](#)
8. Reach inside the computer and push the metal plate towards you so that it snaps off of the computer.

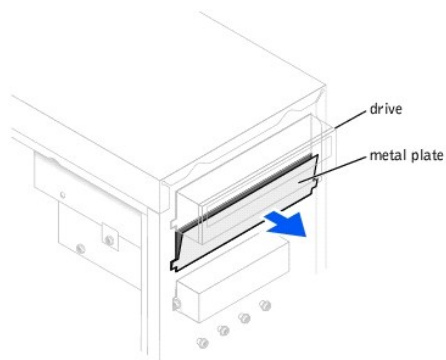

9. Ensure that the jumper setting on the new drive is set for "cable select" (see the documentation that came with the drive for information).
10. Remove two of the extra alignment screws from the front of the computer and insert them into the drive.

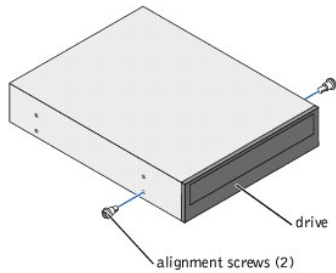

HINT: Some computers come with only two extra alignment screws; others come with four. You only need two alignment screws for this procedure.

11. Gently slide the drive into place.
12. Once the drive is in place, apply pressure to ensure the drive is fully seated.
13. Use the securing screw that came with the drive to attach the drive to the computer.

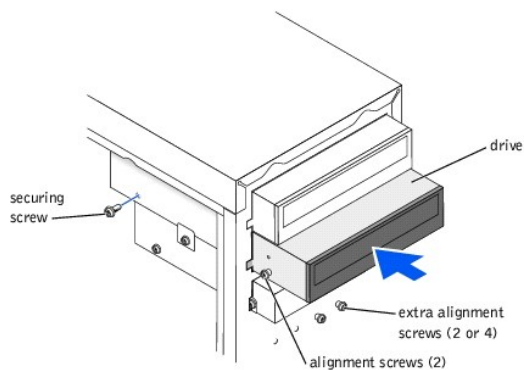

14. Connect a power cable to the new drive.

CAUTION: Match the colored strip on the cable with pin 1 on the drive (pin 1 is marked as "1").

15. Locate the data cable from the CD/DVD drive in the upper drive bay and connect its middle data connector to the new drive.
16. Check all cable connections, and fold cables out of the way to provide airflow for the fan and cooling vents.
17. [Replace the front panel.](#)
18. [Replace the computer cover.](#)

NOTICE: To connect a network cable, first plug the cable into the network wall jack and then plug it into the computer.

19. Connect your computer and devices to electrical outlets, and turn them on.
20. See the documentation that came with the drive for instructions on installing any software required for drive operation.

Replacing the Microprocessor

Removing the Microprocessor

CAUTION: Before you begin any of the procedures in this section, follow the safety instructions provided in your *Owner's Manual*.

CAUTION: To guard against electrical shock, always unplug your computer from the electrical outlet before opening the cover.

1. [Shut down the computer](#) through the **Start** menu.
2. Ensure that your computer and attached devices are turned off. If your computer and attached devices did not automatically turn off when you shut down your computer, turn them off now.

NOTICE: To disconnect a network cable, first unplug the cable from your computer and then unplug it from the network wall jack.

3. Disconnect any telephone or telecommunication lines from the computer.

4. Disconnect your computer and all attached devices from their electrical outlets, and then press the power button to ground the system board.
5. [Remove the computer cover.](#)

➡ **NOTICE:** Before touching anything inside your computer, ground yourself by touching an unpainted metal surface, such as the metal at the back of the computer. While you work, periodically touch an unpainted metal surface to dissipate any static electricity that could harm internal components.

6. Lift up the heat-sink shroud.
7. Press down on the latches to remove the securing clips from the heat sink.

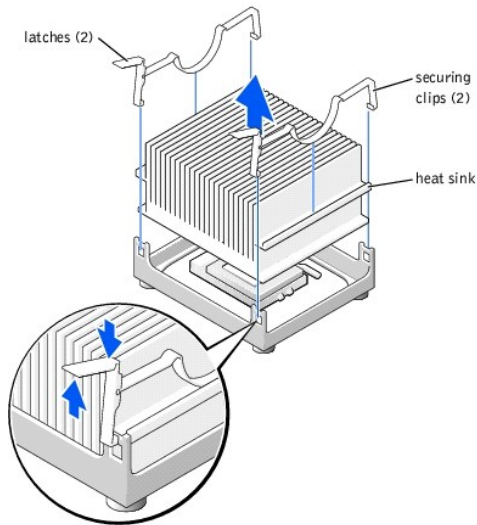

➡ **NOTICE:** Lay the heat sink down with the thermal material facing upward.

8. Lift the heat sink away from the microprocessor.

➡ **NOTICE:** Do not discard the original heat sink and securing clips unless you are installing a microprocessor upgrade kit from Dell. If you are *not* installing a microprocessor upgrade kit from Dell, reuse the original heat sink, blower, and securing clips when installing your new microprocessor.

➡ **NOTICE:** Be careful not to bend any of the pins when you remove the microprocessor from its socket. Bending the pins can permanently damage the microprocessor.

Your microprocessor socket is a zero insertion force (ZIF) socket with a lever-type handle that secures the microprocessor in, or releases it from, the socket.

9. Pull the release lever straight up until the microprocessor is released, and then remove the microprocessor from the socket.
10. Leave the release lever extended so that the socket is ready for the new microprocessor.

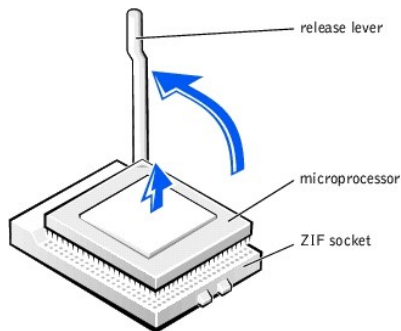

Installing the Microprocessor

➡ **NOTICE:** Ground yourself by touching an unpainted metal surface on the back of the computer.

➡ **NOTICE:** Be careful not to bend any of the pins when you unpack the microprocessor. Bending the pins can permanently damage the microprocessor.

1. Unpack the new microprocessor.

If any of the pins on the microprocessor appears to be bent, see "Contacting Dell" in your *Owner's Manual* for instructions on obtaining technical assistance.

2. Align the pin-1 corner of the microprocessor with the pin-1 corner of the socket.

 **HINT:** You must identify the pin-1 corner to correctly position the microprocessor.

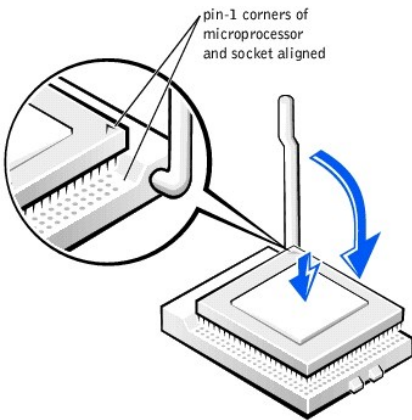

 **NOTICE:** You must position the microprocessor correctly in the socket to avoid permanent damage to the microprocessor and the computer when you turn on the computer.

3. If the release lever on the socket is not fully extended, move it to that position now.
4. With the pin-1 corners of the microprocessor and socket aligned, align the pins on the microprocessor with the holes in the socket.

 **NOTICE:** When you place the microprocessor in the socket, ensure that all of the pins go into the corresponding holes on all sides of the socket. Be careful not to bend the pins.

5. Set the microprocessor lightly in the socket and ensure that all pins are headed into the correct holes. Because your computer uses a ZIF socket, there is no need to use force (which could bend the pins if the microprocessor is misaligned). When the microprocessor is positioned correctly, press it with minimal pressure to seat it.
6. When the microprocessor is fully seated in the socket, pivot the release lever back toward the socket until it snaps into place, securing the microprocessor.

 **NOTICE:** Ground yourself by touching an unpainted metal surface on the back of the computer.

 **NOTICE:** If you are installing a microprocessor replacement kit from Dell, return the microprocessor to Dell in the same package in which your replacement kit was sent.

 **NOTICE:** If you are *not* installing a microprocessor upgrade kit from Dell, reuse the original blower/heat sink assembly and securing clips when replacing the microprocessor.

7. Remove the film covering the thermal material on the bottom of the heat sink.
8. Lower the heat sink to the microprocessor so that the heat sink fits in the retention base.
9. For each of the replacement securing clips, fit the end of the clip that does *not* have the latch over the tab on the retention base. Then, press down on the clip's latch to secure the clip to the retention base ([see the figure](#)).
10. Lower the heat-sink shroud.
11. [Replace the computer cover](#).

 **NOTICE:** To connect a network cable, first plug the cable into the network wall jack and then plug it into the computer.

12. Connect your computer and devices to electrical outlets, and turn them on.

If you are installing a microprocessor replacement kit from Dell, return the original heat sink assembly and microprocessor package to Dell in the same package in which your replacement kit was sent. Your microprocessor replacement kit should include a replacement microprocessor heat sink and one replacement securing clip.

Replacing the System Board

Removing the System Board

 **CAUTION:** Before you begin any of the procedures in this section, follow the safety instructions provided in your *Owner's Manual*.

 **CAUTION:** To guard against electrical shock, always unplug your computer from the electrical outlet before opening the cover.

1. [Shut down the computer](#) through the **Start** menu.
2. Ensure that your computer and attached devices are turned off. If your computer and attached devices did not automatically turn off when you shut down your computer, turn them off now.

➡ **NOTICE:** To disconnect a network cable, first unplug the cable from your computer and then unplug it from the network wall jack.

3. Disconnect any telephone or telecommunication lines from the computer.
4. Disconnect your computer and all attached devices from their electrical outlets, and then press the power button to ground the system board.

⚠ **CAUTION:** To guard against electrical shock, always unplug your computer from the electrical outlet before opening the cover.

5. [Remove the computer cover](#).

➡ **NOTICE:** Before touching anything inside your computer, ground yourself by touching an unpainted metal surface, such as the metal at the back of the computer. While you work, periodically touch an unpainted metal surface to dissipate any static electricity that could harm internal components.

6. [Remove the floppy drive](#).
7. [Remove any cards](#) that are installed.
8. Disconnect all cables from the system board.
9. Lift up the heat-sink shroud.

⚠ **CAUTION:** The microprocessor heat sink can get hot. To avoid burns, ensure that the heat sink has had sufficient time to cool before you touch it.

10. [Remove the microprocessor heat sink](#).
11. Remove the 12 screws that secure the system board to the computer frame.

Four of the 12 screws that secure the system board to the computer frame also secure the heat-sink base to the system board.

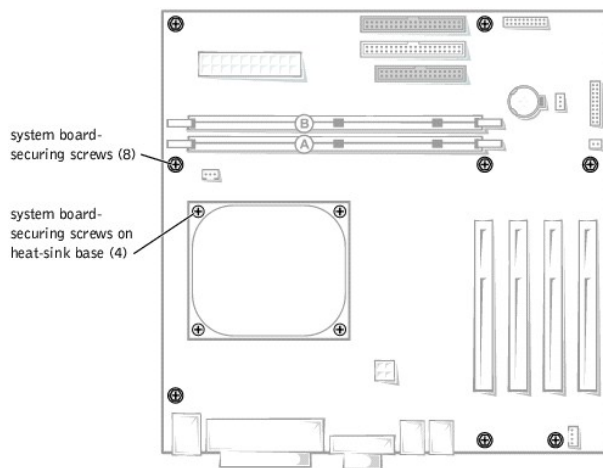

12. Lift the system board out from the computer.
13. Place the system board that you just removed next to the replacement system board.

Visually compare the replacement system board to the existing system board to ensure that you have the correct part.

Installing the System Board

1. Transfer components from the existing system board to the replacement system board:
 - a. [Remove the memory modules and install them](#) on the replacement board.

⚠ **CAUTION:** The microprocessor package can get hot. To avoid burns, ensure that the package has had sufficient time to cool before you touch it.

- b. [Remove the microprocessor package](#) from the existing system board and transfer it to the replacement system board.

2. Configure the settings of the replacement system board.

Set the jumpers on the replacement system board so that they are identical to the ones on the existing board.

3. Place the system board inside the computer frame, place the heat-sink base on the system board, and then replace the screws that you removed in [step 11](#) of the preceding procedure.

4. Reinstall the microprocessor heat sink, and then lower the heat sink shroud.
5. Reattach the cables to the system board.
6. Reinstall any cards.
7. [Replace the floppy drive.](#)
8. [Replace the computer cover.](#)

➡ **NOTICE:** To connect a network cable, first plug the cable into the network wall jack and then plug it into the computer.

9. Connect your computer and devices to electrical outlets, and turn them on.
-

Replacing the Power Supply

Removing the Power Supply

⚠ **CAUTION:** Before you begin any of the procedures in this section, follow the safety instructions provided in your *Owner's Manual*.

⚠ **CAUTION:** To guard against electrical shock, always unplug your computer from the electrical outlet before opening the cover.

1. [Shut down the computer](#) through the **Start** menu.
2. Ensure that your computer and attached devices are turned off. If your computer and attached devices did not automatically turn off when you shut down your computer, turn them off now.

➡ **NOTICE:** To disconnect a network cable, first unplug the cable from your computer and then unplug it from the network wall jack.

3. Disconnect any telephone or telecommunication lines from the computer.
4. Disconnect your computer and all attached devices from their electrical outlets, and then press the power button to ground the system board.

⚠ **CAUTION:** To guard against electrical shock, always unplug your computer from the electrical outlet before opening the cover.

5. [Remove the computer cover.](#)

➡ **NOTICE:** Before touching anything inside your computer, ground yourself by touching an unpainted metal surface, such as the metal at the back of the computer. While you work, periodically touch an unpainted metal surface to dissipate any static electricity that could harm internal components.

6. Disconnect the AC power cable from the AC power connector on the back of the power supply.
7. Unplug the DC power cables from the drives and system board.
8. Remove the four screws that secure the power supply to the back of the computer.

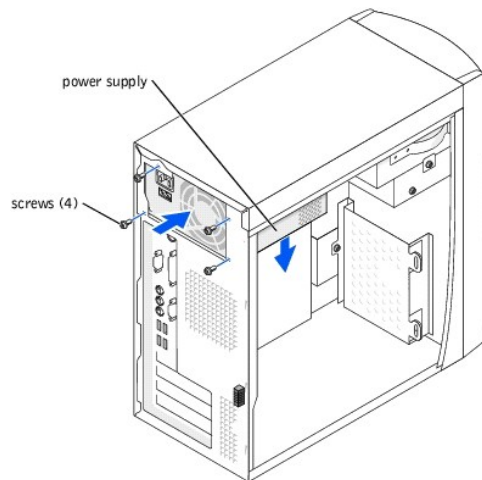

9. Remove the power supply from the computer.

Replacing the Power Supply

1. Slide the power supply into place.
2. Replace the four screws that secure the power supply to the back of the computer.

3. Reconnect the DC power cables to the drives and system board.
4. [Replace the computer cover.](#)
5. Connect the AC power cable to the AC power connector on the back of the power supply.

🔗 **NOTICE:** To connect a network cable, first plug the cable into the network wall jack and then plug it into the computer.

6. Connect your computer and devices to electrical outlets, and turn them on.
-

Replacing the Battery

⚠️ **CAUTION:** Before you begin any of the procedures in this section, follow the safety instructions provided in your *Owner's Manual*.

⚠️ **CAUTION:** To guard against electrical shock, always unplug your computer from the electrical outlet before opening the cover.

A coin-cell battery maintains computer configuration, date, and time information. The battery can last several years.

If you have to repeatedly reset time and date information after turning on the computer, replace the battery.

⚠️ **CAUTION:** A new battery can explode if it is incorrectly installed. Replace the 3-V CR2032 battery only with the same or equivalent type recommended by the manufacturer. Discard used batteries according to the manufacturer's instructions (see "Battery Disposal" in your *Owner's Manual*).

1. Record all the screens in the [system setup program](#) so that you can restore the correct settings when you perform [step 11](#).
2. [Shut down the computer](#) through the **Start** menu.
3. Ensure that your computer and attached devices are turned off. If your computer and attached devices did not automatically turn off when you shut down your computer, turn them off now.

🔗 **NOTICE:** To disconnect a network cable, first unplug the cable from your computer and then unplug it from the network wall jack.

4. Disconnect any telephone or telecommunication lines from the computer.
5. Disconnect your computer and all attached devices from their electrical outlets, and then press the power button to ground the system board.

⚠️ **CAUTION:** To guard against electrical shock, always unplug your computer from the electrical outlet before opening the cover.

6. [Remove the computer cover.](#)

🔗 **NOTICE:** Before touching anything inside your computer, ground yourself by touching an unpainted metal surface, such as the metal at the back of the computer. While you work, periodically touch an unpainted metal surface to dissipate any static electricity that could harm internal components.

🔗 **NOTICE:** To avoid damage to the system board while you pry the battery loose, be sure to insert the plastic screwdriver between the battery and the socket (not the system board).

7. [Locate the battery socket](#) on the system board and pry the battery out of its socket with your fingers or with a plastic screwdriver.
8. Insert the battery into the socket with the side labeled "+" facing up.

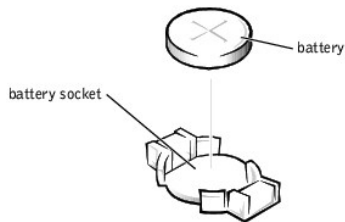

9. [Replace the computer cover.](#)

🔗 **NOTICE:** To connect a network cable, first plug the cable into the network wall jack and then plug it into the computer.

10. Connect your computer and devices to electrical outlets, and turn them on.
 11. Access the [system setup program](#) and restore the settings you recorded in [step 1](#).
-

Replacing the Computer Cover

1. Ensure that all cables are connected, and fold cables out of the way. Make sure cables are not routed over the drive cage—they will prevent the cover

from closing properly.

2. Ensure that no tools or extra parts are left inside the computer.
3. Place the computer cover on the computer.
4. Slide the computer cover towards the front of the computer until it fits completely into place.
5. Tighten the computer cover thumbscrew.

 **NOTICE:** To connect a network cable, first plug the cable into the network wall jack and then plug it into the computer.

6. Connect your computer and devices to electrical outlets, and then turn them on.

[Back to Contents Page](#)

[Back to Contents Page](#)

Solving Problems

Dell™ Dimension™ 2300

- [Finding Help Information](#)
- [Battery Problems](#)
- [Drive Problems](#)
- [E-Mail, Modem, and Internet Problems](#)
- [Error Messages](#)
- [General Problems](#)
- [Keyboard Problems](#)
- [Mouse Problems](#)
- [Network Problems](#)
- [Power Problems](#)
- [Printer Problems](#)
- [Scanner Problems](#)
- [Sound and Speaker Problems](#)
- [Video and Monitor Problems](#)

Finding Help Information

To access the *Tell Me How* help file —

1. Click the **Start** button, and then click **Help and Support**.
2. Click **User and system guides**, and then click **User's guides**.
3. Click **Tell Me How**.

To access Windows help —

1. Click the **Start** button, and then click **Help and Support**.
2. Type a word or phrase that describes your problem, and then click the arrow icon.
3. Click the topic that describes your problem.
4. Follow the instructions shown on the screen.

To locate additional information for your computer — See "[Finding Information for Your Computer](#)."

Battery Problems

CAUTION: There is a danger of a new battery exploding if it is incorrectly installed. Replace the battery only with the same or equivalent type recommended by the manufacturer. Discard used batteries according to the manufacturer's instructions.

CAUTION: Before you begin any of the procedures in this section, follow the safety instructions in your *Owner's Manual*.

Replace the battery — If you have to repeatedly reset time and date information after turning on the computer, or if an incorrect time or date displays during start-up, replace the battery as described in the *Owner's Manual*. If the battery still does not work properly, contact Dell (see "Contacting Dell" in your *Owner's Manual* for the correct number to call).

Drive Problems

Floppy drive problems

Ensure that Windows® recognizes the drive — Click the **Start** button and click **My Computer**. If the floppy drive is not listed, perform a full scan with your antivirus software to check for and remove viruses. Viruses can sometimes prevent Windows from recognizing the drive.

Test the drive —

1. Insert another disk to eliminate the possibility that the original floppy disk is defective.
1. Insert a bootable floppy disk and reboot the computer.

Ensure that the disk is not full or write-protected — Ensure that the disk has available space and that it is not write-protected (locked). See the following illustration.

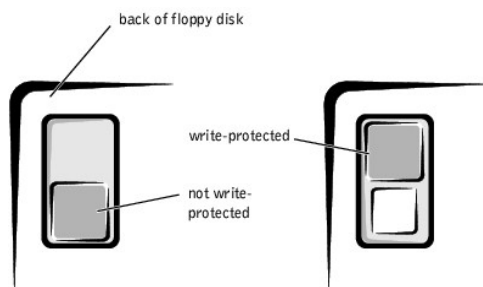

 **NOTICE:** Do not attempt to clean drive heads with a swab. You may accidentally misalign the heads, which can render the drive inoperable.

Clean the drive — Use a commercially available cleaning kit.

CD drive problems

 **HINT:** High-speed CD drive vibration is normal and may cause noise. This does not indicate a defect in the drive or the CD.

Adjust the Windows volume control — Click the speaker icon in the lower-right corner of your screen.

1. Ensure that the volume is turned up by clicking the slider and dragging it up.
1. Ensure that the sound is not muted by clicking any boxes that are checked.

Test the drive with another CD — Insert another CD to eliminate the possibility that the original CD is defective.

Check the speakers and subwoofer — See "[Sound and Speaker Problems](#)."

Ensure that Windows recognizes the drive — Click the **Start** button and click **My Computer**. If the CD drive is not listed, perform a full scan with your antivirus software to check for and remove viruses. Viruses can sometimes prevent Windows from recognizing the drive.

Clean the disc — See the *Tell Me How* help file for instructions on cleaning your CDs. To access help files, see "[Finding Help Information](#)."

Problems writing to a CD-RW drive

Close other programs — The CD-RW drive must receive a steady stream of data when writing. If the stream is interrupted, an error occurs. Try closing all programs before writing to the CD-RW.

Turn off Standby mode in Windows before writing to a CD-RW disc — For information on power conservation modes, see the *Tell Me How* help file or search for the keyword *standby* in Windows Help. To access help files, see "[Finding Help Information](#)."

DVD drive problems

 **HINT:** Because of different regions worldwide and different disc formats, not all DVD titles work in all DVD drives.

Test the drive with another DVD — Insert another DVD to eliminate the possibility that the original DVD is defective.

Ensure that Windows recognizes the drive — Click the **Start** button and click **My Computer**. If the DVD drive is not listed, perform a full scan with your antivirus software to check for and remove viruses. Viruses can sometimes prevent Windows from recognizing the drive.

Clean the disc — See the *Tell Me How* help file for instructions on cleaning your DVDs. To access help files, see "[Finding Help Information](#)."

Check for interrupt request conflicts — See "[Resolving Software and Hardware Incompatibilities](#)."

Hard drive problems

Run Check Disk —

1. Click the **Start** button and click **My Computer**.
2. Right-click the drive letter (local disk) that you want to scan for errors, and then click **Properties**.
3. Click the **Tools** tab.
4. Under **Error-checking**, click **Check Now**.
5. Click **Start**.

E-Mail, Modem, and Internet Problems

 **HINT:** Connect the modem to an analog telephone jack only. The modem does not operate while it is connected to a digital telephone network.

Check the telephone line connection — Verify that the telephone line is connected to the jack on the modem. (The jack has either a green label or a connector-shaped icon next to it.) Ensure that you hear a click when you insert the telephone line connector into the modem.

Check the telephone jack — Disconnect the telephone line from the modem and connect it to a telephone. Listen for a dial tone.

Connect the modem directly to the telephone wall jack — If you have other telephone devices sharing the line, such as an answering machine, fax machine, surge protector, or line splitter, then bypass them and use the telephone to connect the modem directly to the telephone wall jack.

Use a different telephone line — If you are using a line that is 3 m (10 ft) or more in length, try a shorter one.

Run the Modem Helper diagnostics — Click the **Start** button, point to **All Programs**, and then click **Modem Helper**. Follow the instructions on the screen to identify and resolve modem problems. (Modem Helper is not available on all computers.)

Verify that the modem is communicating with Windows® —

1. Click the **Start** button, and then click **Control Panel**.
2. Click **Printers and Other Hardware**.
3. Click **Phone and Modem Options**.
4. Click the **Modems** tab.
5. Click the COM port for your modem.
6. Click **Properties**, click the **Diagnostics** tab, and then click **Query Modem** to verify that the modem is communicating with Windows.

If all commands receive responses, the modem is operating properly.
Turn off call waiting (catch-phone) — See your telephone directory for instructions on deactivating this feature. Then adjust the dial-up networking connection properties. <ol style="list-style-type: none"> 1. Click the Start button, and then click Control Panel. 2. Click Printers and Other Hardware, and then click Phone and Modem Options. 3. Click your connection type to highlight it. 4. Click the Dialing Rules tab, and then click Edit. 5. Click the To Disable Call Waiting box to place a checkmark in it. 6. Select the disable code from the drop-down menu (for example, *70). 7. Click Apply, and then click OK.
Ensure that you are connected to the Internet — With the Outlook Express e-mail program open, click File . If Work Offline has a checkmark next to it, click the checkmark to remove it and connect to the Internet.
Ensure that you have subscribed to an Internet service provider — Contact an Internet service provider to subscribe.
Contact your Internet service provider — Contact your Internet service provider for assistance.
Check for interrupt request conflicts — See " Resolving Software and Hardware Incompatibilities ."

Error Messages

A filename cannot contain any of the following characters: \ / : * ? " < > — Do not use these characters in filenames.
A required .DLL file was not found — The program that you are trying to open is missing an essential file. To remove and then reinstall the program: <ol style="list-style-type: none"> 1. Click the Start button. 2. Click Control Panel. 3. Click Add or Remove Programs. 4. Select the program you want to remove. 5. Click the Change or Remove Program icon. 6. See the program documentation for installation instructions.
Insert bootable media — The operating system is trying to boot to a nonbootable floppy disk or CD. Insert a bootable floppy disk or CD.
Non-system disk error — A floppy disk is in the floppy drive. Remove the floppy disk and restart the computer.
Not enough memory or resources. Close some programs and try again — You have too many programs open. Close all windows and open the program that you want to use. In some cases, you might have to restart your computer to restore computer resources. If so, try running the program that you want to use first.
Operating system not found — Contact Dell (see "Contacting Dell" in your <i>Owner's Manual</i> for the correct number to call).
The file being copied is too large for the destination drive — The file that you are trying to copy is too large to fit on the disk. Try copying the file to a blank disk or using a larger-capacity disk.
x:\ is not accessible. The device is not ready — Insert a disk into the drive and try again.

General Problems

The computer stops responding

Turn the computer off — If your computer locks up and you are unable to get a response by pressing a key on your keyboard or moving your mouse, press and hold the power button for at least 8 to 10 seconds until the computer turns off. Then press the power button again to turn on the computer. You might lose data if you are unable to perform an operating system shutdown.

A program stops responding

End the program — <ol style="list-style-type: none"> 1. Press <Ctrl><Shift><Esc> simultaneously. 2. Click Applications. 3. Click the program that is no longer responding. 4. Click End Task.

A program crashes repeatedly

 **HINT:** Software usually includes installation instructions in its documentation or on a floppy disk or CD.

Check the software documentation — Many software manufacturers maintain websites with information that may help you solve the problem. Ensure that you properly installed and configured the program. If necessary, uninstall and then reinstall the program.

A program is designed for an earlier Windows operating system

Run the Program Compatibility Wizard —

Windows XP provides a Program Compatibility Wizard that configures a program so it runs in an environment similar to non-Windows XP operating system environments.

1. Click the **Start** button, point to **All Programs**→ **Accessories**, and then click **Program Compatibility Wizard**.
2. In the welcome screen, click **Next**.
3. Follow the instructions on the screen.

A solid blue screen appears

Turn the computer off — If the computer does not respond to a keystroke or a proper shutdown, press the power button for at least 8 to 10 seconds until the computer turns off. Press the power button again to restart the computer. The chkdsk program automatically runs during the start-up process. Follow the instructions on the screen.

Other software problems

Check the software documentation or contact the software manufacturer for troubleshooting information

Back up your files immediately — If your computer has a CD-RW drive or a zip drive installed, see the drive's documentation for instructions.

Ensure that you have not made an error while entering data — See the program documentation to make sure that the values or characters you are entering are valid.

Check for viruses — Use a virus-scanning program to check the hard drive, floppy disks, or CDs.

Restart the computer — Save and close any open files, exit any open programs, and then shut down your computer through the **Start** menu instead of pressing the power button. Otherwise, you may lose data.

Check for compatibility —

1. Ensure that the program is compatible with the operating system installed on your computer and that your computer meets the minimum hardware requirements needed to run the software. See the software documentation for information.
1. If necessary, uninstall and then reinstall the program.

Ensure that you properly installed and configured the program — See the software documentation for information. If necessary, uninstall and then reinstall the program.

Other technical problems

Go to the Dell Support website — Go to support.dell.com for help with general usage, installation, and troubleshooting questions. The support website offers several different tools to help you, such as Dell Forum—a chat room where you can communicate with other Dell customers about their computers and gain access to technical support through e-mail. See "Dell Support Website" in your *Owner's Manual* for more information about the website. See "Dell Technical Support Policy (U.S. Only)" in your *Owner's Manual* for a description of the hardware and software support provided by Dell.

Call Dell — If you cannot solve your problem using the Dell Support website or e-mail service, call Dell for technical assistance (see your *Owner's Manual*). See "Dell Technical Support Policy (U.S. Only)" in your *Owner's Manual* for a description of the hardware and software support provided by Dell.

General hardware problems

If your computer exhibits one or more of the following symptoms, a device conflict may exist:

1. Your computer locks up, particularly while using a specific device.
1. A recently added device does not work.
1. A sound card emits noise or demonstrates other problems.
1. Unintelligible characters print from the printer.
1. The mouse pointer does not move or "stutters" when it moves.
1. Messages appear stating that the computer is not operating at maximum performance.
1. Errors occur and programs crash for no apparent reason.
1. Nothing displays on the monitor.

Remove any recently added hardware to see if it resolves the conflict — If removing the hardware resolves the conflict, see the hardware documentation for configuration and troubleshooting instructions. If the problem persists, contact the hardware manufacturer for technical assistance.

Check your operating system documentation for additional troubleshooting information

Check for interrupt request conflicts —

See "[Resolving Software and Hardware Incompatibilities.](#)"

Keyboard Problems

Restart the computer —

- 1 If the mouse is functioning, [shut down the computer](#) through the **Start** menu. After the computer shuts down, press the power button to restart the computer.
- 1 If the computer does not respond to a keystroke or the mouse, press the power button for at least 8 to 10 seconds until the computer turns off. Press the power button again to restart the computer.

Check the keyboard cable —

- 1 Ensure that the keyboard cable is firmly connected to the computer.
- 1 [Shut down the computer](#), reconnect the keyboard cable as shown on the *Start Here* setup diagram for your computer, and then restart the computer.
- 1 Ensure that the keyboard cable is firmly connected to the computer.
- 1 Check the cable connector for bent or broken pins and for damaged or frayed cables. Straighten bent pins.
- 1 Remove keyboard extension cables and connect the keyboard directly to the computer.

Test the keyboard — Connect a properly working keyboard to the computer, and try using the keyboard. If the new keyboard works, the original keyboard is faulty.

Check for interrupt request conflicts — See "[Resolving Software and Hardware Incompatibilities.](#)"

Mouse Problems

Restart the computer —

1. Simultaneously press <Ctrl><Esc> to display the **Start** menu.
2. Type **u**, press the keyboard arrow keys to highlight **Shut down** or **Turn Off**, and then press <Enter>.
3. After the computer turns off, press the power button to restart the computer.

If you connected the mouse before turning on the computer, reconnect the mouse cable —

1. Simultaneously press <Ctrl><Esc> to display the **Start** menu.
2. Type **u**, press the keyboard arrow keys to highlight **Shut down** or **Turn Off**, and then press <Enter>.
3. After the computer turns off, reconnect the mouse cable as shown on the *Start Here* setup diagram for your computer.
4. Start the computer.

If you connected the mouse after turning on the computer, remove the power cable, and then reconnect the mouse cable —

If the mouse is connected after the power is turned on, the mouse appears to be nonfunctional. To make the mouse function properly:

1. While your computer is on, remove the power cable from the back of the computer.
2. Connect the mouse to the computer.
3. Reconnect the power cable.
4. Turn on your computer.

Pressing the power button does not clear the computer's settings and does not restore mouse functionality.

Check the mouse cable —

- 1 Check the cable connector for bent or broken pins and for damaged or frayed cables. Straighten bent pins.
- 1 Ensure that the cable is firmly connected to the computer.

Test the mouse — Connect a properly working mouse to the computer, and try using the mouse. If the new mouse works, the original mouse was faulty.

Check the mouse settings —

1. Click the **Start** button, click **Control Panel**, and then click **Printers and Other Hardware**.
2. Click **Mouse**.
3. Try adjusting the settings.

Reinstall the mouse driver — See "[Reinstalling Drivers.](#)"

Check for interrupt request conflicts — See "[Resolving Software and Hardware Incompatibilities.](#)"

Network Problems

Check the network cable connector — Ensure that the network cable is connected as shown in "Setting Up a Home and Office Network" in your *Owner's Manual*.

Check the network lights on the back of the computer —

No light indicates that there is no network communication. Try replacing the network cable.



Restart the computer and try to log on to the network again

Check your network settings — Contact your network administrator or the person who set up your network to verify that your network settings are correct and that the network is functioning.

Check for interrupt request conflicts — See "[Resolving Software and Hardware Incompatibilities](#)."

Power Problems

CAUTION: Before you begin any of the procedures in this section, follow the safety instructions in your *Owner's Manual*.

Adjust the Power Properties — Your computer may be in standby or hibernate mode. For information on power conservation modes, see the *Tell Me How* help file, or search for the keyword *standby* or *hibernate* in Windows® Help. To access help files, see "[Finding Help Information](#)."

If the power light is blinking green — The computer is in standby mode. Press a key on the keyboard or move the mouse to resume normal operation.

If the power light is off — The computer is either turned off or is not receiving power.

- 1 Ensure that the power cable is firmly inserted into both the power connector on the back of the computer and the electrical outlet.
- 1 If the computer is plugged into a power strip, ensure that the power strip is plugged into an electrical outlet and that the power strip is turned on.
- 1 Ensure that the electrical outlet is working by testing it with another device, such as a lamp.
- 1 Ensure that the voltage selection switch is set to match the AC power at your location (see the safety instructions in your *Owner's Manual*).
- 1 Bypass power protection devices, power strips, and power extension cables to verify that the computer turns on.
- 1 Swap the computer and monitor power cables to determine if the power cable is defective.
- 1 Ensure that the microprocessor power cable is securely connected to the [system board](#).
- 1 Ensure that the power supply cables are securely connected to the [system board](#).
- 1 Remove and then reinstall the [memory modules](#).
- 1 Remove and then reinstall any [cards](#).
- 1 If the problem persists, contact Dell (see "Contacting Dell" in your *Owner's Manual* for the correct number to call).

Eliminate interference — Electrical appliances on the same circuit or operating near the computer can cause interference. Other causes of interference are:

- 1 Power extension cables
- 1 Keyboard and mouse extension cables
- 1 Too many devices on a power strip
- 1 Multiple power strips connected to the same electrical outlet

Printer Problems

HINT: Dell does not cover the printer's warranty. If you need technical assistance for your printer, call the printer's manufacturer. See the printer documentation for the correct phone number.

Check the printer documentation — See the printer documentation for setup and troubleshooting information.

Ensure that the printer is turned on —

See the printer documentation for power button information.

Verify the printer cable connections —

- 1 See the printer documentation for cable connection information.
- 1 Ensure that the printer cables are securely connected to the printer and the computer (see "Connecting a Printer" in your *Owner's Manual*).

Test the electrical outlet —

Ensure that the electrical outlet is working by testing it with another device, such as a lamp.

Verify that the printer is recognized by Windows® —

1. Click the **Start** button.
2. Click **Control Panel**.
3. Click **Printers and Other Hardware**.
4. Click **View installed printers or fax printers**.

If the printer is listed, right-click the printer icon.

5. Click **Properties**, and then select the **Ports** tab. For a parallel printer, ensure that the **Print to the following port(s):** setting is **LPT1 (Printer Port)**. For a USB printer, ensure that the **Print to the following port(s):** setting is **USB**.

Reinstall the printer driver —

See the printer documentation for instructions.

Scanner Problems

 **HINT:** Dell does not cover the scanner's warranty. If you need technical assistance for your scanner, call the scanner's manufacturer. See the scanner documentation for the correct phone number.

Check the scanner documentation —

See the scanner documentation for setup and troubleshooting information.

Unlock the scanner —

Ensure that your scanner is unlocked if it has a locking tab or button.

Restart the computer and try the scanner again

Check the cable connections —

- 1 If your scanner has a power cable, ensure that the power cable is firmly connected to a working electrical outlet and that the scanner is turned on.
- 1 Ensure that the scanner cable is firmly connected to the computer and to the scanner.

Verify that the scanner is recognized by Microsoft® Windows® —

1. Click the **Start** button.
2. Click **Control Panel**.
3. Click **Printers and Other Hardware**.
4. Click **Scanners and Cameras**.

If your scanner is listed, Windows recognizes the scanner.

Reinstall the scanner driver —

See the scanner documentation for instructions.

Sound and Speaker Problems

No sound from speakers

 **HINT:** The volume control in some MP3 players overrides the Windows® volume setting. If you have been listening to MP3 songs, ensure that you did not turn the player volume down or off.

Check the speaker cable connections — Ensure that the speakers are connected as shown on the setup diagram supplied with the speakers.

Ensure that the subwoofer and the speakers are turned on — See the setup diagram supplied with the speakers. If your speakers have volume controls, adjust the volume, bass, or treble to eliminate distortion.

Adjust the Windows volume control — Click or double-click the speaker icon in the lower-right corner of your screen. Ensure that the volume is turned up and that the sound is not muted.

Disconnect headphones from the headphone connector — Sound from the speakers is automatically disabled when headphones are connected to the computer's front-panel headphone connector.

Enable digital mode — Your speakers do not work if the CD or DVD drive is not operating in digital mode. To enable digital mode:

1. Click the **Start** button, click **Control Panel**, and then click **Sounds, Speech, and Audio Devices**.
2. Click **Sounds and Audio Devices**.
3. Click the **Hardware** tab.
4. Double-click the name of your CD drive.
5. Click the **Properties** tab.
6. Check the **Enable digital CD audio for this CD-ROM device** box.

Test the electrical outlet — Ensure that the electrical outlet is working by testing it with another device, such as a lamp.

Eliminate possible interference — Turn off nearby fans, fluorescent lights, or halogen lamps to check for interference.

Run the speaker diagnostics — Some speaker systems have self- diagnostics. See the speaker documentation for diagnostics instructions.

Reinstall the audio (sound) driver — See "[Reinstalling Drivers](#)."

Check for interrupt request conflicts — See "[Resolving Software and Hardware Incompatibilities](#)."

No sound from headphones

Check the headphone cable connection — Ensure that the headphone cable is securely inserted into the [headphone connector](#).

Adjust the Windows volume control — Click or double-click the speaker icon in the lower-right corner of your screen. Ensure that the volume is turned up and that the sound is not muted.

Disable digital mode — Your headphones do not work if the CD drive is operating in digital mode. To disable digital mode:

1. Click the **Start** button, click **Control Panel**, and then click **Sounds, Speech, and Audio Devices**.
2. Click **Sounds and Audio Devices**.
3. Click the **Hardware** tab.

4. Double-click the name of your CD drive.
5. Click the **Properties** tab.
6. Uncheck the **Enable digital CD audio for this CD-ROM device** box.

Video and Monitor Problems

If the screen is blank

 **HINT:** See the monitor documentation for troubleshooting procedures.

Check the monitor power light — If the power light is off, firmly press the button to ensure that the monitor is turned on. If the power light is lit or blinking, the monitor has power. If the power light is blinking, press a key on the keyboard or move the mouse.

Check the monitor cable connection — Check the connector for bent or broken pins. (It is normal for monitor cable connectors to have missing pins.) Ensure that the video cable is connected as shown on the *Start Here* setup diagram for your computer.

Test the electrical outlet — Ensure that the electrical outlet is working by testing it with another device, such as a lamp.

Swap the power cables — Swap the computer and monitor power cables to determine if the power cable is defective.

Test the video extension cable (if used) — If you are using a video extension cable and removing the cable solves the problem, the cable is defective.

Test another monitor — If another monitor is available, connect it to the computer.

If the screen is difficult to read

Check the monitor settings — See the monitor documentation for instructions on adjusting the contrast and brightness, demagnetizing (degaussing) the monitor, and running the monitor self-test.

Move the subwoofer away from the monitor — If your speaker system includes a subwoofer, ensure that the subwoofer is at least 60 cm (2 ft) away from the monitor.

Move the monitor away from external power sources — Fans, fluorescent lights, halogen lamps, and other electrical devices can cause the screen image to appear "shaky." Turn off nearby devices to check for interference.

Rotate the monitor to face a different direction — Eliminate sunlight glare, which can cause poor picture quality.

Adjust the Windows® display settings —

1. Click the **Start** button, and then click **Control Panel**.
2. Click **Appearance and Themes**.
3. Click **Display**, and then click the **Settings** tab.
4. Try different settings for **Screen resolution** and **Color quality**.

Restore the recommended settings — Restore the original resolution and refresh rate settings. See the *Tell Me How* help file for instructions. To access help files, see "[Finding Help Information](#)."

[Back to Contents Page](#)

[Back to Contents Page](#)

Technical Specifications

Dell™ Dimension™ 2300

- [Microprocessor](#)
- [System Information](#)
- [Expansion Bus](#)
- [Memory](#)
- [Drives](#)
- [Ports and Connectors](#)
- [Video](#)
- [Audio](#)
- [Controls and Lights](#)
- [Power](#)
- [Physical](#)
- [Environmental](#)

Microprocessor	
Microprocessor type	Intel® Pentium® 4 that runs at 1.80 GHz internally and 400 MHz externally or Intel Celeron® that runs at 1.70 GHz internally and 400 MHz externally <i>NOTE: Microprocessor offerings vary by country.</i>
L1 cache	8 KB first-level (Pentium 4); 32 KB (16-KB data cache; 16-KB instruction cache) (Celeron).
L2 cache	256- or 512-KB (displayed in the system setup program) pipelined-burst, eight-way set associative, write-back SRAM (Pentium 4); 128-KB SRAM that resides in the processor's core. The L2 cache runs at the processor's internal clock speed (Celeron).

System Information	
System chip set	Intel 845GL
DMA channels	seven
Interrupt levels	24 APIC mode
System BIOS chip	2 Mb (256 KB)
System clock	400-MHz data rate

Expansion Bus	
Bus types	PCI
Bus speed	PCI: 33 MHz
PCI connectors	four
PCI connector size	120 pins
PCI connector data width (maximum)	32 bits

Memory	
Architecture	SDRAM
Memory connectors	two
Memory capacities	128-, 256-, or 512-MB
Minimum memory	128 MB
Maximum memory	1 GB
Memory type	PC133 SDRAM (non-ECC)

Drives	
Externally accessible	two 5.25-inch bays one 3.5-inch bay
Internally accessible	one bay for 1-inch-high IDE hard drive

Ports and Connectors	
Externally accessible:	
Serial	9-pin connector; 16550C-compatible
Parallel	25-hole connector (bidirectional)
Video	15-hole connector
Keyboard	6-pin mini-DIN connector
Mouse	6-pin mini-DIN connector
USB	two front-panel and four back-panel USB 2.0-compliant connectors

Audio	three back miniature connectors for line-in, line-out, and microphone; one front miniature connector for line-out
Internally accessible:	
Primary IDE channel	40-pin connector on PCI local bus
Secondary IDE channel	40-pin connector on PCI local bus
Floppy drive	34-pin connector

Video	
Video controller	Intel integrated AGP graphics*
*Integrated AGP graphics uses a maximum of 32 MB of main memory.	

Audio	
Audio controller	Integrated AC97

Controls and Lights	
Power control	push button
Front-panel power light	solid green for power-on state; blinking green for standby state
Hard-drive access light	green

Power	
DC power supply:	
Wattage	200 W
Heat dissipation	682 BTU (fully-loaded computer without monitor)
Voltage (see the safety instructions in your <i>Owner's Manual</i> for important voltage setting information)	100 to 120 V at 60 Hz; 200 to 240 V at 50 Hz
Backup battery	3-V CR2032 coin cell

Physical	
Height x Width x Depth	36.8 x 18.4 x 42.6 cm (14.5 x 7.25 x 16.75 inches)
Weight	10.4 kg (23 lb)

Environmental	
Temperature:	
Operating	0° to 35°C (32° to 95°F)
Storage	-20° to 70°C (-4° to 158°F)
Relative humidity	20% to 80% (noncondensing)
Maximum vibration:	
Operating	0.25 G at 10 to 500 Hz at 1/2 octave/min
Storage	1.48 G at 10 to 500 Hz, vibration with the computer
Maximum shock:	
Nonoperating (half-sine pulse)	105 G, 2 ms
Nonoperating (faired-square wave)	32 G with a velocity change of 596.9 cm/sec (235 inches/sec)

[Back to Contents Page](#)

[Back to Contents Page](#)

System Setup Program

Dell™ Dimension™ 2300

- [Overview](#)
 - [Entering the System Setup Program](#)
 - [Main Screen](#)
 - [Advanced Screen](#)
 - [Security Screen](#)
 - [Power Screen](#)
 - [Boot Screen](#)
 - [Exit Screen](#)
 - [Clearing Forgotten Passwords](#)
 - [Clearing CMOS](#)
-

Overview

Each time you turn on or restart your computer, the computer compares the hardware installed in the computer to the hardware listed in the configuration information stored in NVRAM on the system board. If the computer detects a discrepancy between the two, it generates error messages that identify the incorrect configuration settings. The computer then prompts you to enter the system setup program to correct the setting.

You can use the system setup program to perform the following tasks:

- 1 To change the system configuration information after you add, change, or remove any hardware in your computer
- 1 To set or change user-selectable options, such as the user password

Dell recommends that you write down the system setup program screen information for future reference.

The system setup screens are organized as follows:

- 1 The top of the screen has a menu bar for accessing the main program screens.
- 1 The box on the left side of each screen lists options that define the hardware installed in the computer. Fields beside the options contain settings or values. You can change the settings or values that are enclosed in brackets. Values that are grayed out contain status information reported by the computer.
- 1 The box on the right side of each screen displays help information for the option with a currently highlighted field.
- 1 The lower area of the screen lists keys and their functions for the currently displayed screen.

The menu bar provides access to the following screens:

- 1 [Main screen](#) — Provides settings for the basic computer configuration
- 1 [Advanced screen](#) — Provides detailed settings for some computer features
- 1 [Security screen](#) — Provides indications and settings for system password and setup password
- 1 [Power screen](#) — Provides settings for system power management features
- 1 [Boot screen](#) — Provides information about which device boots the computer
- 1 [Exit screen](#) — Provides selections for saving and loading the configurations and options

In addition to these screens, options identified by a right arrow provide access to submenus.

Entering the System Setup Program

1. Turn on (or restart) your computer.
2. When the blue DELL™ logo appears, press <F2>.

If you wait too long and the operating system begins to load into memory, let the computer complete the load operation. Then shut down the computer and try again.

Main Screen

Main		Advanced	Security	Power	Boot	Exit
Date (mm:dd:yy)	mm:dd:yy					Item Help
Time (hh:mm:ss)	hh:mm:ss					
BIOS version	xxxx					
Processor Type	Pentium® 4					
Processor Speed	xxxx GHz					
System Bus Speed	xxxx MHz					
Cache RAM	xxxx KB					
Service Tag	xxxxxx					
Total Memory	xxxx MB					
Memory Bank0	xxxx MB					
Memory Bank1	[Not Installed]					
→ ← Move Menu ↑ ↓ Move Item Tab: Move Field Enter: Select +/-/PU/PD: Value Esc: Exit F10: Save F1: General Help F5: Previous Values F9: Setup Defaults						

Option	Function
Date	Resets the time on the computer's internal calendar.
Time	Resets the time on the computer's internal clock.
BIOS Version	Displays the version of the BIOS being used.
Processor Type	Displays the type of microprocessor installed.
Processor Speed	Displays the internal speed of the microprocessor.
System Bus Speed	Displays the external speed of the microprocessor.
Cache RAM	Displays the microprocessor's cache RAM size.
Service Tag	Displays the computer's service tag number.
Total Memory	Displays the total computer memory.
Memory Bank0	Displays the memory size installed in memory bank 0.
Memory Bank1	Displays the memory size installed in memory bank 1.

Advanced Screen

Main		Advanced	Security	Power	Boot	Exit
Reset Configuration Data	[Disabled]					Item Specific Help
NumLock	[On]					
▶ Peripheral Configuration						
▶ IDE Configuration						
▶ Diskette Configuration						
▶ Event Log Configuration						
→ ← Move Menu ↑ ↓ Move Item Tab: Move Field Enter: Select +/-/PU/PD: Value Esc: Exit F10: Save F1: General Help F5: Previous Values F9: Setup Defaults						

Option	Function
Reset Configuration Data	Options are Disabled (default) and Enabled . Select Enabled to reset ESCD when you exit the system setup program if you have installed a new device and the system reconfiguration has caused such a serious conflict that the operating system cannot start.
NumLock	Selects power-on state for Numlock. Options are On (default) and Off .
Peripheral Configuration	Displays the Peripheral Configuration submenu .
IDE Configuration	Displays the IDE Configuration submenu .
Diskette Configuration	Displays the Diskette Configuration submenu .
Event Log Configuration	Displays the Event Log Configuration submenu .

Peripheral Configuration Submenu

Advanced	
Peripheral Configuration	Item Specific Help
USB Controller [Enabled] Legacy USB Support [Enabled]	
Integrated Audio [Enabled] Serial Port [Auto] Parallel Port [Auto] Parallel Port Mode [Bi-directional] x ECP Mode Use DMA [3]	

→ ← Move Menu ↑ ↓ Move Item Tab: Move Field Enter: Select +/- /PU/PD: Value
Esc: Exit F10: Save F1: General Help F5: Previous Values F9: Setup Defaults

Option	Function
USB Controller	Sets the USB controller to either Enabled (default) or Disabled .
Legacy USB Support	Set to Disabled if legacy USB support is not desired. Enabled (default) allows support for legacy USB.
Integrated Audio	Sets the integrated audio controller to either Enabled (default) or Disabled .
Serial Port	Sets the integrated serial port setting to Auto , (default) 2E8/IRQ3 , 3E8/IRQ4 , 2F8/IRQ3 , 3F8/IRQ4 , or Disabled .
Parallel Port	Sets the integrated parallel port setting to Auto , (default) 3BC/IRQ7 , 278/IRQ5 , 378/IRQ7 , or Disabled .
Parallel Port Mode	Sets the integrated parallel port mode to Bi-directional (default), Output Only , ECP , or EPP .
ECP Mode Use DMA	If the Parallel Port Mode option is set to ECP , this setting selects the ECP DMA mode. The options are 3 (default) and 1 .

IDE Configuration Submenu

Advanced	
IDE Configuration	Item Specific Help
Primary IDE Controller [Enabled] Secondary IDE Controller [Enabled]	
▶ IDE Primary Master [device name] ▶ IDE Primary Slave [device name] ▶ IDE Secondary Master [device name] ▶ IDE Secondary Slave [device name]	

→ ← Move Menu ↑ ↓ Move Item Tab: Move Field Enter: Select +/- /PU/PD: Value
Esc: Exit F10: Save F1: General Help F5: Previous Values F9: Setup Defaults

Option	Function
Primary IDE Controller	Configures the integrated primary IDE controller as either Enabled (default) or Disabled .
Secondary IDE Controller	Configures the integrated secondary IDE controller as either Enabled (default) or Disabled .
IDE Primary Master	Identifies the first drive attached to the primary IDE interface, usually the boot hard drive. See " IDE Primary Master Submenu ."
IDE Primary Slave	Identifies the second drive attached to the primary IDE interface, usually a second hard drive. The format of this submenu is the same as the one described in " IDE Primary Master Submenu ."
IDE Secondary Master	Identifies the first drive attached to the secondary IDE interface, if there is one. The format of this submenu is the same as the one described in " IDE Primary Master Submenu ."
IDE Secondary Slave	Identifies the first drive attached to the secondary IDE interface, if there is one. The format of this submenu is the same as the one described in " IDE Primary Master Submenu ."

IDE Primary Master Submenu

Advanced		Item Specific Help
IDE HDD Auto-Detection	[Press Enter]	
IDE Primary Master	[Auto]	
Capacity	20021 MB	
Cylinder	38792	
Head	16	
Precoup	0	
Landing Zone	38791	
Sector	63	
Access Mode	[Auto]	
PIO Mode	[Auto]	
UDMA Mode	[Auto]	

→ ← Move Menu ↑ ↓ Move Item Tab: Move Field Enter: Select +/- /PU/PD: Value
 Esc: Exit F10: Save F1: General Help F5: Previous Values F9: Setup Defaults

Option	Function
IDE HDD Auto-Detection	Press <Enter> to start auto-detection for the primary IDE hard drive.
IDE Primary Master	Specifies the type of hard drive. Settings for this option are Auto (default), None , and Manual .
Capacity	Displays the maximum capacity of the primary IDE device.
Cylinder, Head, Precoup, Landing Zone, Sector	Displays each setting of the primary IDE device.
Access Mode	Sets the access mode of the primary IDE device. The options are Auto (default), CHS , LBA , and Large .
PIO Mode	Sets the PIO mode of the primary IDE device. The options are Auto (default), Mode 0 , Mode 1 , Mode 2 , Mode 3 , and Mode 4 .
UDMA Mode	Sets the ultra DMA setting of the primary IDE device as either Auto (default) or Disabled .

Diskette Configuration Submenu

Advanced		Item Specific Help
Diskette Configuration		
Diskette Controller:	[Enabled]	
Drive A:	[1.44M, 3.5 in]	
Floppy 3 Mode Support	[Disabled]	
Diskette Write Protect:	[Disabled]	

→ ← Move Menu ↑ ↓ Move Item Tab: Move Field Enter: Select +/- /PU/PD: Value
 Esc: Exit F10: Save F1: General Help F5: Previous Values F9: Setup Defaults

Option	Function
Diskette Controller	Configures the floppy drive interface. Options are Enabled (default) and Disabled .
Drive A:	Selects the floppy drive type as 1.44M, 3.5 in (default); None ; 360K, 5.25 in ; 1.2M, 5.25 in ; 720K, 3.5 in ; or 2.88M, 3.5 in .
Floppy 3 Mode Support	Selects Floppy 3 mode support for the floppy drive. Options are Disabled (default) and Drive A .
Diskette Write Protect	Protects a floppy disk from being written to when set to Enabled . When this option is set to Disabled (default), the floppy disk is not protected unless the write-protect tab is in place.

Event Log Configuration Submenu

Advanced

Event Log Configuration	Item Specific Help
Event Logging [Enabled] Clear Event Log [No]	
View Event Log [Enter] Mark Events as Read [Enter]	
Event Log Capacity Space Available Event Log Validity Valid	

→ ← Move Menu ↑ ↓ Move Item Tab: Move Field Enter: Select +/- /PU/PD: Value
Esc: Exit F10: Save F1: General Help F5: Previous Values F9: Setup Defaults

Option	Function
Event Logging	The event log function is activated when set to Enabled (default). Disabled deactivates the event log function.
Clear Event Log	Clears the event log when the computer restarts if set to Yes . Retains the event log information if set to No (default).
View Event Log	Press <Enter> to view the event log.
Mark Events As Read	Press <Enter>, and then select Yes or No to mark DMI events as either read or unread.
Event Log Capacity	Displays the space available for the event log.
Event Log Validity	Displays the validity of the event log.

Security Screen

Main Advanced Security Power Boot Exit

Security Configuration	Item Specific Help
Supervisor Password Is: Not Installed User Password Is: Not Installed Set Supervisor Password Set User Password	

→ ← Move Menu ↑ ↓ Move Item Tab: Move Field Enter: Select +/- /PU/PD: Value
Esc: Exit F10: Save F1: General Help F5: Previous Values F9: Setup Defaults

Option	Function
Supervisor Password Is	Indicates whether a supervisor password has been assigned.
User Password Is	Indicates whether a user password has been assigned.
Set Supervisor Password	Press <Enter> to set and confirm a supervisor password. Pressing <Enter> twice resets a supervisor password.
Set User Password	Press <Enter> to set and confirm a user password. Pressing <Enter> twice resets a user password.

Power Screen

Main	Advanced	Security	Power	Boot	Exit
ACPI Suspend Type	[S3]				Item Specific Help
Wake-Up by PCI Device	[Enabled]				
AC Power Recovery	[Off]				

→ ← Move Menu ↑ ↓ Move Item Tab: Move Field Enter: Select +/-/PU/PD: Value
 Esc: Exit F10: Save F1: General Help F5: Previous Values F9: Setup Defaults

Option	Function
ACPI Suspend Type	Determines the ACPI suspend type. Options are S3 (default) and S1 .
Wake-Up by PCI Device	Allows a PCI device to wake up the computer. The options are Enabled (default) and Disabled .
AC Power Recovery	Determines what state the computer enters when AC power is restored after a power loss. Settings are as follows: <ul style="list-style-type: none"> 1 Last State Computer returns to the state it was in when power was lost. 1 Off (default) Computer stays off when power is restored; you must press the power button to turn on the computer. 1 On Computer turns on when power is restored.

Boot Screen

Main	Advanced	Security	Power	Boot	Exit
Quiet Boot	[Enabled]				Item Specific Help
Quick Boot	[Enabled]				
1st Boot Device	[Floppy]				
2nd Boot Device	[Hard Disk]				
3rd Boot Device	[CDROM]				
4th Boot Device	[Disabled]				
▶ Hard Disk Boot Priority					

→ ← Move Menu ↑ ↓ Move Item Tab: Move Field Enter: Select +/-/PU/PD: Value
 Esc: Exit F10: Save F1: General Help F5: Previous Values F9: Setup Defaults

Option	Function
Quiet Boot	Enabled (default) displays the DELL logo during POST. Disabled displays the normal POST messages.
Quick Boot	When set to Enabled , this option shortens POST by eliminating some tests. If set to Disabled (default), all POST tests occur.
1st Boot Device through 4th Boot Device	Sets the boot device sequence. Only the bootable devices that are connected to the computer are listed as options.
Hard Disk Boot Priority	Sets the hard drive boot priority. Options are Pri.M (device name) (default) and Bootable Add-in Cards .

Exit Screen

Main	Advanced	Security	Power	Boot	Exit
Exit Saving Changes Exit Discarding Changes Load Setup Defaults Load Custom Defaults Save Custom Defaults Discard Changes					Item Specific Help
→ ← Move Menu ↑ ↓ Move Item Tab: Move Field Enter: Select +/- /PU/PD: Value Esc: Exit F10: Save F1: General Help F5: Previous Values F9: Setup Defaults					

Option	Function
Exit Saving Changes	Saves any changes you have made, exits the system setup program, and restarts the computer.
Exit Discarding Changes	Discards any changes you have made, exits the system setup program, and restarts the computer.
Load Setup Defaults	Discards any changes you have made and reverts all options to their defaults, but does not exit the system setup program.
Load Custom Defaults	Discards any changes you have made and reverts all options to their defaults, but does not exit the system setup program.
Save Custom Defaults	Saves any changes you have made, but does not exit the system setup program.
Discard Changes	Discards any changes you have made and reverts all options to their last saved settings, but does not exit the system setup program.

Clearing Forgotten Passwords

⚠ CAUTION: Before you begin any of the procedures in this section, follow the safety instructions provided in your *Owner's Manual*.

If you forget your supervisor or setup password, you cannot operate your computer or change settings in the system setup program until you clear the forgotten password(s).

1. [Shut down the computer.](#)
 2. Turn off any attached devices and disconnect them from their electrical outlets.
- 🔍 **NOTICE:** To disconnect a network cable, first unplug the cable from your computer and then unplug it from the network wall jack.
3. Disconnect the power cable from your computer, and then press the power button to ground the system board.
 4. [Remove the computer cover.](#)
 5. Locate the 2-pin [password jumper](#) on the system board, and then attach the jumper to both pins.
The jumper is attached to only one pin for shipping.
 6. [Replace the computer cover.](#)
 7. Connect your computer and devices to electrical outlets, and turn them on.
 8. After the Microsoft® Windows® desktop appears on your screen, [shut down the computer.](#)
- 🔍 **NOTICE:** To disconnect a network cable, first unplug the cable from your computer and then unplug it from the network wall jack.
9. Turn off any attached devices and disconnect them from their electrical outlets.
 10. Disconnect the power cable from your computer, and then press the power button to ground the system board.
 11. [Remove the computer cover.](#)
 12. Remove the password jumper.
Attach the jumper to only one pin so that you do not lose it.
 13. [Replace the computer cover.](#)
- 🔍 **NOTICE:** To connect a network cable, first plug the cable into the network wall jack and then plug it into the computer.

14. Connect your computer and devices to electrical outlets, and turn them on.
 15. If you are prompted to press <F1> to continue, press <F1>.
-

Clearing CMOS

 **CAUTION:** Before you begin any of the procedures in this section, follow the safety instructions provided in your *Owner's Manual*.

 **NOTICE:** The following procedure resets all standard settings for your computer. Before proceeding, record all current settings so that you can restore them when you finish this procedure.

To clear the computer's CMOS:

1. [Shut down the computer.](#)

 **NOTICE:** To disconnect a network cable, first unplug the cable from your computer and then unplug it from the network wall jack.

2. Turn off any attached devices and disconnect them from their electrical outlets.
3. Disconnect the power cable from your computer, and then press the power button to ground the system board.
4. [Remove the computer cover.](#)
5. Locate the 3-pin [CMOS jumper](#) on the system board. The jumper is on the first two jumper pins nearest the back of the computer. Move the jumper to the two pins nearest the front of the computer, wait approximately 5 seconds, and then move the jumper back to its original position.
6. [Replace the computer cover.](#)

 **NOTICE:** To connect a network cable, first plug the cable into the network wall jack and then plug it into the computer.

7. Connect your computer and devices to electrical outlets, and turn them on.
 8. If you are prompted to press <F1> to continue, press <F1>.
-

[Back to Contents Page](#)

Technical Overview

Dell™ Dimension™ 2300

- [Internal View](#)
- [System Board Connectors and Sockets](#)
- [Power Supply DC Connector Pin Assignments](#)

Internal View

- ⚠ **CAUTION:** Before you begin any of the procedures in this section, follow the safety instructions provided in your *Owner's Manual*.
- ⚠ **CAUTION:** To guard against electrical shock, always unplug your computer from the electrical outlet before opening the computer cover.

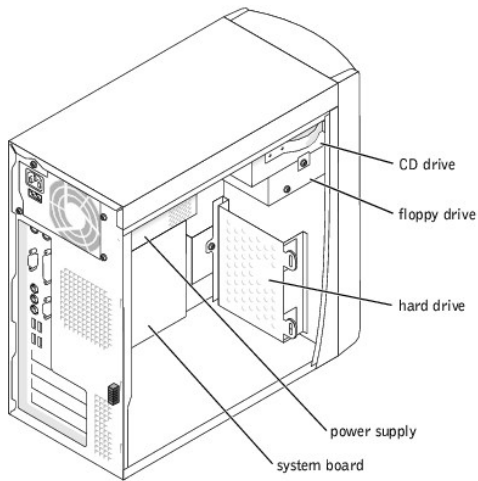

System Board Connectors and Sockets

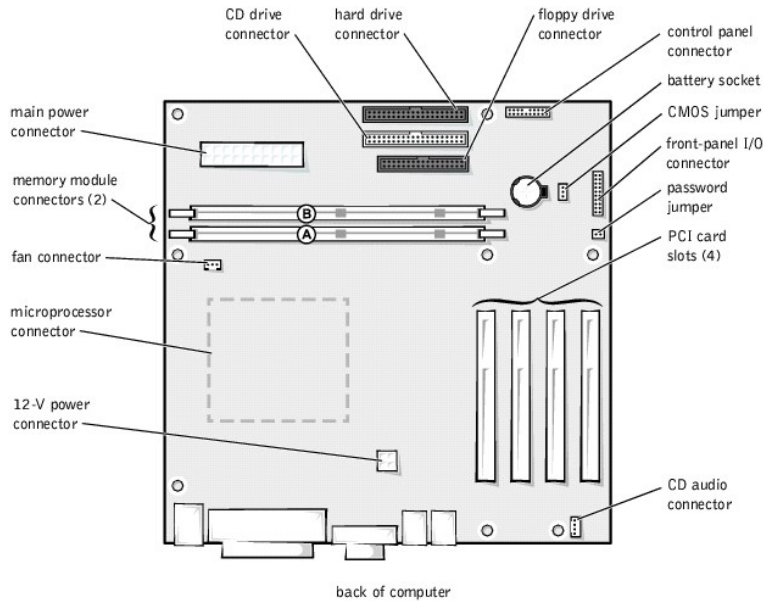

Power Supply DC Connector Pin Assignments

DC Power Connector P1

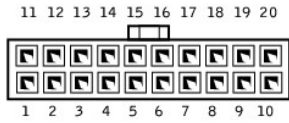

Pin Number	Signal name	18-AWG Wire
1	+3.3 VDC	Orange
2	+3.3 VDC	Orange
3	COM	Black
4	+5 VDC	Red
5	COM	Black
6	+5 VDC	Red
7	COM	Black
8	POK*	Gray
9	+5 VFP	Purple
10	+12 VDC	Yellow
11	+3.3 VDC	Orange
12	-12 VDC*	Blue
13	COM	Black
14	PS ON*	Green
15	COM	Black
16	COM	Black
17	COM	Black
18	-5 VDC	White
19	+5 VDC	Red
20	+5 VDC	Red

*Use 22-AWG wire instead of 18-AWG wire.

DC Power Connectors P2, P3, P5, and P6

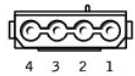

Pin Number	Signal Name	18-AWG Wire
1	+12 VDC	Yellow
2	COM	Black
3	COM	Black
4	+5 VDC	Red

DC Power Connector P7

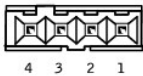

Pin Number	Signal Name	22-AWG Wire
1	+5 VDC	Red
2	COM	Black
3	COM	Black
4	+12 VDC	Yellow

DC Power Connector P8



Pin Number	Signal Name	18-AWG Wire
1	COM	Black
2	COM	Black
3	+ 12 VDC	Yellow
4	+ 12 VDC	Yellow

[Back to Contents Page](#)

Controls and Lights



Dell™ Dimension™ 2300

● [Front View](#)

● [Back View](#)

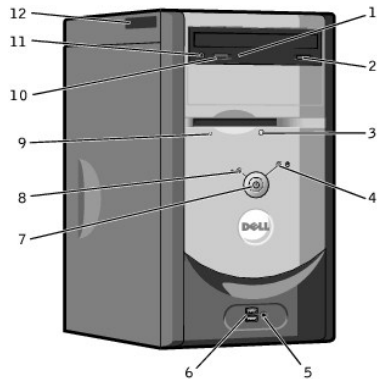
Front View



1	CD or DVD drive activity light	The drive activity light is on when the computer reads data from the CD or DVD drive.
2	CD or DVD eject button	Press this button to eject your disc from the CD or DVD drive.
3	Floppy drive eject button	Press this button to eject a disk from the floppy drive.
4	Hard-drive activity light	The hard drive light is on when the computer reads data from or writes data to your hard drive.
5	Headphone connector	Use the headphone connector to attach headphones and most speakers for listening to sounds in your computer, including sound from your CD or DVD player.
6	USB 2.0 connectors (2)	For quick connections, it is recommended that you use the front USB connectors for USB devices such as digital cameras, gaming controllers, and scanners. Use the back-panel USB connectors for USB mouse and keyboard connections.
7	Power button	Press the power button to turn on the computer.  NOTICE: To turn off your computer, perform a Windows® shutdown instead of pressing the power button. Otherwise, you may lose data.
8	Power light	The power light is solid green for the computer's power-on state and blinking green for its standby state.
9	Floppy drive light	The floppy drive light is on when the computer reads data from or writes data to the floppy drive.
10	CD or DVD volume control dial	Move the dial to adjust the CD- or DVD-drive headphone connector volume of your audio CD or DVD disc.
11	CD or DVD headphone connector	Use the headphone connector to attach headphones to the CD or DVD drive. Your headphones won't work if the drive is operating in digital mode. To disable digital mode: <ol style="list-style-type: none"> 1. Click the Start button, click Control Panel, and then click Sounds, Speech, and Audio Devices. 2. Click Sounds and Audio Devices. 3. Click the Hardware tab. 4. Double-click the name of your CD or DVD drive. 5. Click the Properties tab. 6. Uncheck the Enable digital CD audio for this CD-ROM device box.
12	Service tag	 HINT: Express Service may not be available in some countries. This label lists your computer's service tag and your Express Service Code (if applicable). If you call Dell technical support, use your Express Service Code to route the call directly to the correct support personnel. The Dell technical support staff will ask for your service tag.

Back View

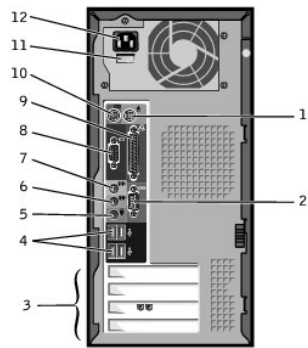

1	mouse connector	Plug your computer's PS/2 mouse into the green mouse connector. Turn off the computer and any attached devices before you connect a mouse to the computer.
2	serial connector	Connect a serial device, such as a handheld device, to the serial connector.
3	PCI card slots (4)	Use these slots for a PCI card, such as a modem or a network adapter.
4	USB 2.0 connectors (4)	Connect a USB device such as a mouse, keyboard, printer, joystick, and speaker system into any of the USB connectors.
5	microphone connector	Use the pink microphone connector to attach a personal computer microphone for voice or musical input to a sound or telephony program.
6	line-in connector	Use the blue line-in connector to attach a record/playback device such as a cassette player, CD player, or VCR.
7	line-out connector	Use the green line-out connector to attach headphones and most speakers with integrated amplifiers.
8	video connector	Plug the cable from your monitor into the blue connector.
9	parallel connector	Connect a parallel device, such as a printer, to the parallel connector. If you have a USB printer, plug it into a USB connector.
10	keyboard connector	Plug your computer's PS/2 keyboard into the purple keyboard connector. Turn off the computer and any attached devices before you connect a keyboard to the computer.
11	voltage selection switch	See the safety instructions in your <i>Owner's Manual</i> for more information.
12	power connector	Connect the power cable.

[Back to Contents Page](#)

[Back to Contents Page](#)

Dell™ Dimension™ 2300

● [Hints, Notices, and Cautions](#)

Hints, Notices, and Cautions



HINT: A HINT indicates important information that helps you make better use of your computer.



NOTICE: A NOTICE indicates either potential damage to hardware or loss of data and tells you how to avoid the problem.



CAUTION: A CAUTION indicates a potential for property damage, personal injury, or death.

Information in this document is subject to change without notice.
© 2002 Dell Computer Corporation. All rights reserved.

Reproduction in any manner whatsoever without the written permission of Dell Computer Corporation is strictly forbidden.

Trademarks used in this text: *Dell*, the *DELL* logo, and *Dimension* are trademarks of Dell Computer Corporation; *Intel* and *Celeron* are registered trademarks of Intel Corporation; *Microsoft* and *Windows* are registered trademarks of Microsoft Corporation; *Adobe* is a trademark of Adobe Systems Incorporated, which may be registered in certain jurisdictions.

Other trademarks and trade names may be used in this document to refer to either the entities claiming the marks and names or their products. Dell Computer Corporation disclaims any proprietary interest in trademarks and trade names other than its own.

This product incorporates copyright protection technology that is protected by method claims of certain U.S. patents and other intellectual property rights owned by Macrovision Corporation and other rights owners. Use of this copyright protection technology must be authorized by Macrovision Corporation, and is intended for home and other limited viewing uses only unless otherwise authorized by Macrovision Corporation. Reverse engineering or disassembly is prohibited.

August 2002 Rev. A00

[Back to Contents Page](#)